

Part 800 Pedestrian Design

Section 801 Introduction

The purpose of this section is to provide design standards for pedestrian facilities on state highways. Other sections in this manual address the design of the roadway realm and bicycle realm including geometric considerations for intersections, interchanges, urban design, and public transportation amenities. Information on pedestrian design considerations as it relates to those amenities are in other sections of this manual. Reference Part 900 for discussion on design principles in areas where pedestrians and bicyclist interactions occur.

A thorough guide for bicycle and pedestrian design is contained in Appendix L, the Oregon Bicycle and Pedestrian Design Guide. Where there is a discrepancy between content in this Part 800 and the Oregon Bicycle and Pedestrian Design Guide, Part 800 takes precedence. The Oregon Bicycle and Pedestrian Design Guide is for use by local agencies to develop their standard of practice for the bicycle and pedestrian realms. The Oregon Bicycle and Pedestrian Design Guide (Appendix L) contains design guidance that may only apply to city and county roads.

To reflect ODOT's commitment to provide facilities for pedestrians with varying abilities, the ODOT design standards for pedestrian facilities in this section may exceed the Americans with Disability Act minimum requirements. The Americans with Disability Act is a federal civil rights law that mandates both the private and public sectors to make their facilities accessible to people with disabilities.

The design standards in this section reflect ODOT's commitment to the US Department of Transportation policy statement, issued on March 11, 2010, recommending that states accommodate bicyclists and pedestrians while accommodating motorized vehicles. The design standards in this section are also reflective of ODOT's statewide initiatives and programs including social equity, climate change, reducing emission goals, reducing the carbon footprint, and making every mile count. Refer to the Oregon Transportation Planning Rule (OAR 660, Division 12) policy and requirements described in Section 109.7 of this manual where applicable climate friendly areas need additional pedestrian amenities, connectivity, and options for transportation.

801.1 Font Key

Text within this part is presented in specific fonts that show the required documentation and/or approval if the design does not meet the requirements shown.

Table 800-1: Font Key

Font Key Term	Font	Deviations	Approver
Standard	Bold text	Design Exceptions	State Traffic-Roadway Engineer (STRE) and, for some projects, FHWA
Guideline	<i>Bold Italics text</i>	Design Decision document	Region with Tech Expert input
Option	<i>Italics Text</i>	Document decisions	EOR
General Text	Not bold or italics	Not applicable	Not applicable

Standard - A statement of required, mandatory, or specifically prohibitive practice regarding a roadway geometric feature or appurtenance. All Standard statements appear in bold type in design parameters. The verb “provide” is typically used. The adjective “required” is typically used in figures to illustrate Standard statements. The verbs “should” and “may” are not used in Standard statements. The adjectives “recommended” and “optional” are only used in Standard statements to describe recommended or optional design features as they relate to required design features. Standard statements are sometimes modified by Options. A design exception is required to modify a Standard. The State Traffic-Roadway Engineer (STRE) gives formal approval, and FHWA approves as required.

Guideline - A statement of recommended practice in typical situations. All Guideline statements appear in bold italicized type in design parameters. The verb “should” is typically used. The adjective “recommended” is typically used in figures to illustrate Guideline statements. The verbs “provide” and “may” are not used in Guideline statements. The adjectives “required” and “optional” are only used in Guideline statements to describe required or optional design features as they relate to recommended design features. Guideline statements are sometimes modified by Options. While a formal design exception is not required, documentation of the decisions made by the Engineer of Record in the Design Decision documentation or other engineering reports is required. Region approval, with input from Technical Experts, is formally recorded via the Urban Design Concurrence Document in the Design Decision portion.

Option - A statement of practice that is a permissive condition and carries no requirement or recommendation. Option statements sometimes contain allowable ranges within a Standard or

Guideline statement. All Option statements appear in italic type in design parameters sections. The verb “may” is typically used. The adjective “optional” is typically used in figures to illustrate Option statements. The verbs “shall” and “should” are not used in Option statements. The adjectives “required” and “recommended” are only used in Option statements to describe required or recommended design features as they relate to optional design features. While a formal design exception is not required, documentation of the decisions made by the Engineer of Record in the Design Decision documentation or other engineering reports is best practice.

General Text - Any informational statement that does not convey any degree of mandate, recommendation, authorization, prohibition, or enforceable condition. The remaining text in the manual is general text and may include supporting information, background discussion, commentary, explanations, information about design process or procedures, description of methods, or potential considerations and all other general discussion. General text statements do not include any special text formatting. General text may be used to inform and support design exception requests, particularly where narrative explanations show best practices or methods of design that support the requested design exception.

See Part 100, Section 101 for additional information.

801.2 Definitions

The following are definitions of words and phrases used in the Highway Design Manual (HDM). Other definitions may be in the individual parts to which they apply. These definitions do not necessarily apply outside the context of the HDM. These definitions identify the ODOT applicable standards and practices for the design and construction on ODOT right of way. Construction of these facilities can be funded with various specialized funding programs with terms that are not synonymous with these definitions. Eligibility for funding is determined by the program definitions, program rules, and program manager.

Unless otherwise defined in this document, the terms used in the HDM are defined according to American Association of State Highway Transportation Officials (AASHTO) A Policy on Geometric Design of Highways and Streets (2018 7th edition) which ODOT has adopted and incorporated into the HDM. Oregon Administrative Rules (OAR) and Oregon Revised Statutes (ORS) have specific definitions for legal regulations that are specific to Oregon Law and may not be in alignment with the HDM definitions. Use collegiate dictionaries to determine the meaning of terms that are not defined in the HDM, AASHTO, and referenced MUTCD standards.

Americans with Disabilities Act (ADA) - Americans with Disabilities Act is a Civil Rights law passed by Congress in the 1990s making it illegal to discriminate against people with disabilities in employment, services provided by state and local governments, public and private transportation, public accommodations and telecommunications.

Architectural Barriers Act (ABA) - A federal law that passed in 1968 mandating facilities designed, built, altered, or leased with federal funds (grants or loans) are accessible in the built environment. This includes facilities such as mass transit systems, transit centers, and rest areas.

Audible Pedestrian Signal (APS) - A device that provides an audible tone to pedestrians that it is safe to cross at a signalized intersection.

Accessible - Features that comply with the ADA and Code of Federal Regulation requirements. People are not discriminated in their ability to use and operate a feature or service, having equitable and comparable ability to use the feature and service independently.

ADA Ramp - See Section 102.

Buffer Zone - The space or zone located between the vehicular travel way and the Pedestrian Zone.

Comment, Question, Concern, or Request (CQCR) - A process where individuals can inform ODOT about a comment, question, concern, or requests related to ADA. It provides an informal process, rather than a formal complaint, to address an ADA concern on or along the state highway system and a plan to track the responses.

Crosswalk - Portion of a roadway designated for pedestrian crossing, marked or unmarked. Unmarked crosswalks are the natural extension of the shoulder, curb line or sidewalk. See the Traffic Manual for more information on where crosswalks exist.

Crossing - The place on public right of way where the pedestrian facility is interrupted by another mode of transportation and may cross the transportation facility to reach a destination. For example, a rail crossing is one type of crossing where the pedestrian crosses the facility at a planned improved area. See the Traffic Manual for definitions of pedestrian crossings.

Closed Crosswalk - (ORS 810.080) A crosswalk where a road authority places and maintains signs giving notice of closure. Pedestrians are prohibited from crossing a roadway at a closed crosswalk (ORS 810.080, ORS 814.020). See the Traffic Manual for more information on crosswalk closures.

Marked Crosswalk - (ORS 801.220) Any portion of a roadway at an intersection or elsewhere that is distinctly indicated for pedestrian crossing by lines or other markings on the surface of the roadway that conform in design to the standards established for crosswalks under ORS 810.200. OAR 734-020-0005 adopts the Manual on Uniform Traffic Control Devices (MUTCD) as those standards. Decorative pavement treatments such as brick, concrete pavers, stamped asphalt, or coloring are not crosswalk markings (see the Traffic Manual for more information on textured and colored crosswalk treatments).

Unmarked Crosswalk - A crosswalk that does not have markings on the surface of the roadway that conform in design to the standards established for crosswalks under ORS 810.200. Sometimes called a crossing in project development. See the Traffic Manual for more information on where crosswalk exists on or along state highways.

Curb Zone - The Curb Zone is the transition segment between a sidewalk and the travel way. It channelizes storm water and discourages vehicles from parking on the sidewalk.

Grade - The steepness of a roadway, bikeway, or walkway, expressed in the ratio of vertical rise per horizontal distance, usually in percent, e.g., a 5 percent grade equals 5 feet of rise over 100 feet of horizontal distance.

Frontage Zone - The portion of the Pedestrian Realm located between the Pedestrian Zone and the public right of way adjacent to the business or private property.

Furniture Zone - The furniture zone is synonymous with "buffer zone" or "furnishing zone".

Hardscape - Solid, hard elements in landscape design that stay the same for years. This includes things like walkways, retaining walls and decorative pavers.

Jurisdictional Transfer (JT) - An action whereby ODOT transfers a state highway section to another jurisdiction or vice versa.

Micro Mobility - Transportation over short distances provided by lightweight, usually single-person devices (such as bicycles and scooters).

Mode (Modal) - A means of moving people or goods. Modes such as rail, transit, carpooling, walking, and bicycling that provide transportation alternatives to single occupancy automobiles are called "alternative modes".

Operable Part - A component of an element used to insert or withdraw objects, or to activate, deactivate, or adjust the element.¹ An example of an operable part is a pedestrian push button used to activate the signalized pedestrian crossing.

Pedestrian - A person on foot, using a personal assistive mobility device, or walking a bicycle.

Pedestrian Access Route - A continuous and unobstructed path for pedestrians to navigate along the sidewalk, driveway, curb ramps, crossings, and pedestrian facilities that is fully accessible.

Pedestrian Circulation Area - A prepared exterior or interior surface provided for pedestrian travel in the public right of way.²

Pedestrian Friendly - Design qualities that make walking attractive, enjoyable, and comfortable, including places people want to go and good facilities to get there.

Pedestrian Realm - The portion of a street right of way dedicated to uses other than moving and parking vehicles. It includes primarily the sidewalk, plantings, and street furniture. The

¹ 2010 ADA Accessibility Standards, Section 106 Definitions

² PROWAG, Section R105 Definitions.

Pedestrian Realm consists of the Buffer Zone/Furniture Zone, the Pedestrian Zone, and the Frontage Zone of a sidewalk or walkway. Curbing is a part of the Transition Realm.

Pedestrian Zone - The portion of a sidewalk or walkway available for pedestrians to traverse, free of obstructions and contains the pedestrian access route.

Planting Strip - That portion of the sidewalk that accommodates street trees, shrubs, grass, or other organic materials.

State Highway System - The state highway system encompasses all public roads and highways under ODOT ownership or jurisdiction. This definition includes those frontage roads and other public roads that may not fall under the statutory definition or the Oregon Highway Plan definition of the state highway system. The state highway system may reside over another's right of way (e.g., United States Forest Land) and ODOT has a permanent easement to operate.

Shared Use Path - An all-weather prepared surface, typically designated by signs and/or markings for use by a pedestrian, bicycle, or a personal wheeled device enabling locomotion for recreation and transportation. A Shared use path is a facility or way that may either be located within a highway right-of-way, parallel to the traveled way (referred to as a side path), or outside the highway right-of-way on a separate alignment or right-of-way. Pedestrians and other wheeled path users utilize the shared space equally and can intermingle in opposing directions of movement. Shared use paths are typically separated physically from motor vehicle traffic by an open space or barrier. The terms "shared use" and "multi use" are interchangeable. Common names for shared use paths often use the terms "trail" or "greenway", although the definition of the term "trail" has other design implications, different from shared use paths.

Sidewalks - The portion of a street between the curb line, or the lateral line of a roadway, and the adjacent property line or on easements of private property that is paved or improved with an all-weather hard surface and intended for use by pedestrians. Sidewalks are designed for preferential or exclusive use by pedestrians and meets ADA standards. This includes the Pedestrian Zone and the Frontage Zone of the Pedestrian Realm.

Softscape - A material that, unlike hardscaping, does not have a long term or permanent quality and may be a living part of the landscape. Softscape consists of elements such as soil, loose rock, sand, bark, plants and shrubs, and turf.

Streetscape - The combination of planters, planting strips, sidewalk, street trees, streetlights, and other pedestrian amenities.

Temporary Pedestrian Access Route Plan (TPARP) - A plan describing the details of how pedestrians can get through or around construction work zones.

Trails - A prepared firm surface for pedestrian, bicycle, or a personal wheeled device enabling locomotion for leisure and recreation activities including but not limited to bicycling, hiking, horseback riding, and walking. Trails can be designated for exclusive use by a mode of travel such as horseback riding.

Transition Plan - A United States Title II requirement for an agency with 50 employees or more that identifies the agency’s outstanding accessibility issues and provides a schedule for eliminating those barriers, both physical and programmatic.

Universal Design - The practice of creating environments and structures that can be easily accessed, understood, and utilized by all people regardless of age, size, and disability. Universal Design benefits all people.³

Walking - Use of human powered forms of transportation, including, but not limited to travel to a destination by foot or wheelchair.

Walkways - A transportation facility built for use by pedestrians, including persons walking or using a personal assistive mobility device. Walkways include sidewalks, pedestrian lanes, shared use path, and trails. The walkway may be divided into the Buffer Zone, Pedestrian Zone, and the Frontage Zone (see Part 300).

Walking Distance - The distance covered walking at an easy pace. This is the distance that most people will walk rather than drive, providing the environment is pedestrian friendly.

Wheelchair - A manually operated or power-driven device designed primarily for use by an individual with a mobility disability for the main purpose of indoor, or of both indoor and outdoor locomotion.⁴

801.3 Acronyms

A list of acronyms specifically introduced in Part 800 is below. Acronyms defined in other Parts of the Highway Design Manual are not repeated in this section.

CQCR	Comment, Question, Concern, or Request
OECR	Office of Equity and Civil Rights
PROWAG	Public Right of Way Accessibility Guidelines
FRA	Federal Rail Administration
US DOT	United States Department of Transportation
US DOJ	United States Department of Justice

³ [National Disability Authority - https://universaldesign.ie/What-is-Universal-Design/](https://universaldesign.ie/What-is-Universal-Design/)

⁴ 28 CFR Part 35 Section 35.104 Definitions

Section 802 Approval Processes

Deviations from a design standard, or which falls outside the standard range requires design exception approval by the State Traffic-Roadway Engineer. When unsure whether a design exception is required, consult with the Technical Services Roadway Engineering Unit. A design exception requires signature by both the Engineer of Record (EOR) and State Traffic-Roadway Engineer. The design exception process is in Part 1000 of the HDM. Design exceptions may also require approval by the Federal Highway Administration (FHWA).

Design guidance has evolved over the years to be more context sensitive and to integrate flexibility. Additionally, design guidance now considers the various modal needs of a transportation system. This evolution reflects the shift from nominal safety (subjective) to substantive safety (objective). Transportation professionals strive to use guidance and standards to support evolving needs and provide a safe and efficient network.

Determine the urban context and the roadway classification, and ODOT procedures for determining S.C.O.P.E. Appendix D discusses information on the Practical Design Strategy. When determining the cross section and standards to use for design, refer for Part 100 for discussion on how the Blueprint for Urban Design and Practical Design methods are applied given the roadway classification and urban context. For example, the scope of a project on a 45-mph state highway on the Urban Fringe includes construction of sidewalk where none existed. The standard is a 6-foot sidewalk behind a 4-foot Buffer Zone per Table 800-3, but only 9 feet of the required 10 feet of right of way are available. A Practical Design approach would be to construct the 6-foot sidewalk with a 3-foot Buffer Zone, which is better than a curb tight (curbside) sidewalk.

Under the Americans with Disabilities Act (ADA), conditions for exceptions to ADA requirements are stipulated in the federal register. When an ADA requirement is infeasible, the burden of proof resides with the agency that constructs the project. Documentation for these ADA exceptions are retained on file using the roadway design exception process discussed in Section 1000. Conditions where an ADA design exception may be considered include:

1. Terrain of the site when it is technically infeasible to comply with the technical requirements.
2. When a technical requirement causes a change to a protected natural or historic resource under federal or state law(s) which alters the function, purpose, or the setting of that facility.

To determine the maximum extent feasible in meeting accessibility requirements, designers should strive to meet design standards by considering as many design options as practicable before seeking ADA design exceptions. Construction of accessible facilities is required where new pedestrian features and facilities are provided, and scope of work cannot be used as a justification for ADA design exceptions to not meet accessibility requirements. Alterations of

existing pedestrian facilities and features may be limited by the scope of the overall improvements and the built environment may be justification for ADA design exceptions.

802.1 Urban Design Concurrence Document

Use the Urban Design Concurrence Document to determine project context, define design criteria, and document design decisions. Authority for approval of the Urban Design Concurrence Document will reside in the Region Technical Center. *The Region Technical Center Manager shall provide final approval of design concurrence with collaborative input from Region Planning, Traffic, Roadway, and Maintenance.* Pedestrian Realm elements contained in the Urban Design Concurrence Document are to be designed in accordance with the standards in Section 800. Refer to Part 300 for more discussion on the Urban Context and Urban Design Concurrence documentation.

802.2 ODOT ADA Curb Ramp Process Document (Appendix G)

This document is intended to give designers, developers and local agencies information and guidance on the ODOT pedestrian curb ramp design and construction acceptance process.

In addition to the civil rights requirements under the Federal Americans with Disabilities Act (ADA), Federal and State Law requires that all projects that receive Federal or State funding meet current Federal and State requirements. The document is intended to help guide local agencies or project teams through the process and expectations set by the Oregon Department of Transportation (ODOT) as an obligation to receive such funds. The document provides milestones, detailed instructions, and a checklist to assist you in meeting the requirements of your project.

The ODOT ADA Curb Ramp Process is based on the ODOT Statewide Transportation Investment Program (STIP) project delivery process. The Local Agency process may be different than ODOT's process presented in this document. The intention of this document is not to constrain an Agency to ODOT's format but for the Agency to incorporate Federal and State requirements and expectations into their process when receiving applicable funds or administering work on the State Highway system.

802.3 CQCR Process for ADA Requests

ODOT established the ADA Comments, Questions, Concerns and Requests (CQCR) program to track and respond to ADA inquiries from members of the public. Utilize the online [ODOT ADA Accessibility Request Form](#) to submit a request; this can be filled out by the individual or on behalf of an individual by an ODOT employee. The CQCR process facilitates the agency's efforts to address citizen reports of access barriers, ADA accommodation requests for ODOT programs or the state highway infrastructure, and other ADA based comments, questions, or concerns. The purpose of the CQCR process is to respond to an individual's need to an existing ADA barrier to the transportation system or service provided by ODOT. Requests may include physical amenities on the state highway and services provided by ODOT.

The CQCR program is coordinated by the Office of Equity and Civil Rights (OECR). ODOT staff from divisions and regional offices across ODOT participate as trained CQCR Coordinators, including regional active transportation liaisons. OECR and the CQCR coordinators strive to provide a customer an initial response within 5 days. Overall, ODOT must communicate the result of a CQCR investigation to the requester within 30 days of submission. If a complex barrier case requires more than 30 days to resolve, the CQCR coordinator will provide updates to the customer as a remediation plan is developed.

Each CQCR inquiry is entered into a central database and a process is in place to evaluate, respond, and find a solution to the request of the individual. The CQCR process documents incremental improvements on the transportation system when full standards are not achieved with the constructed solution. ADA design exceptions are not required for incremental improvements on CQCR projects.

Some solutions may require additional planning, design, and funding to reach a final resolution for individual's accessibility barriers. Project teams need to be aware of locations that have CQCR issues within the project limits. Utilize the FACS-STIP tool to find locations with active CQCR issues. Evaluate CQCR locations and address in the project S.C.O.P.E. and business case development. The regional active transportation liaison is the best resource for additional information on CQCR locations during scoping efforts.

802.4 Crosswalk Location Determinations

When determining where crosswalks are located on the state highway (marked or unmarked), the definition of an intersection is based on the Oregon Revised Statutes ORS 801.220 and ORS 801.320. Crosswalk locations at intersections are often unique with complex geometry. *The Traffic Section assists in these circumstances to determine where crosswalks exist on the state highway.* Refer to Traffic Manual Section 310.0, for the location of crosswalks on state highways. Crosswalks are pedestrian facilities that must be useable and designed for all

pedestrians. Refer to the Traffic Manual for the procedures in crosswalk location determinations. Crosswalk determination letters (Form No. 734-5294) are retained on file, and it will update the asset inventory if applicable.

An intersection exists where two or more roadways join at any angle (ORS 801.320). This includes T-intersections (where two roadways join and one of the roadways ends).

Intersection is described in one of the following circumstances:

1. If the roadways have curbs, the intersection is the area embraced within the prolongation or connection of the lateral curb lines.
2. If the roadways do not have curbs, the intersection is the area embraced within the prolongation or connection of the lateral boundary lines of the roadways.
3. The junction of an alley (ORS 801.110) with a roadway does not constitute an intersection.
4. Where a highway (ORS 801.305) includes two roadways 30 feet or more apart, then every crossing of each roadway of the divided highway by an intersection highway is a separate intersection. In the event the intersection highway also includes two roadways 30 feet or more apart, then every crossing of two roadways of such highways is a separate intersection.

Crosswalks are located at intersections. See the Traffic Manual, Section 310.0 for more information.

802.5 Crosswalk Closures

Sidewalks provide mobility along the highway, but full pedestrian accommodation also requires frequent and convenient crossing opportunities. Wide highways carrying large traffic volumes can be difficult for pedestrians to cross, making facilities on the other side difficult to access. Mid-block and unmarked crossings need to be considered, as people will take the shortest route to their destination. Prohibiting such movements is counter-productive to enhancing community and economic vitality where walking networks improve peoples' ability to access jobs, businesses, and other destinations. The Traffic Manual discusses the procedures to close a crosswalk on the state highway which must be approved by the State Traffic Roadway Engineer. *A closed crosswalk must include notice to the public with signage per ORS 810.080 which indicates pedestrians are prohibited from crossing the roadway.* Any deviation to this requirement is stipulated in the State Traffic Roadway Approval Letter and would be requested in the Crosswalk Closure Approval Request Form 734-5150 for consideration.

Convenient pedestrian crossings cannot be considered in isolation from the following issues, which should be addressed when seeking solutions to specific problems. Appendix L, the

Oregon Bicycle and Pedestrian Design Guide describes each of the following issues in detail. Refer to the Traffic Manual for additional design standards and crossing spacing requirements.

- Volume to Capacity (V/C) and Design Standards (Appendix L, page 5-3)
- Land Use (Appendix L, page 5-4)
- Transit Stops (Appendix L, page 5-4)
- Signal Spacing (Appendix L, page 5-4)
- Access Management (Appendix L, page 5-5)
- Out-of-Direction Travel (Appendix L, page 5-6)
- Midblock versus Intersection Crossings (Appendix L, page 5-6)
- Maintenance (Appendix L, page 5-7)

A decision to close a crosswalk affects ODOT's progress toward achieving goals in the adopted Oregon Bicycle and Pedestrian Plan. Closing a crosswalk removes a link from the surrounding pedestrian network by prohibiting pedestrians from crossing at that location.

802.5.1 Crosswalk Closure Treatments

The state traffic-roadway engineer's crosswalk closure approval may specify some attributes of the crosswalk closure treatments. The following guidance is to aid designers in closure treatment selections and recommendations when closing a crosswalk. **Closure treatments shall be installed at closed crosswalks according to the State Traffic Roadway Engineer's crosswalk closure approval.** Visual and detectable treatments communicate to pedestrians that a crosswalk is closed.

ORS 810.080 requires signs, such as a CROSSWALK CLOSED (OR22-7) sign, to close a crosswalk; this is the visual crosswalk closure treatment. Visual treatments are typically placed so they are visible to a pedestrian as they face the closed crosswalk. The sign may be a separate installation from the detectable closure treatment, and it should be placed in a location, so it is not subject to vandalism or vehicular strikes. Deviations to a visual treatment is stipulated in the State Traffic Roadway Approval Letter and would be requested in the Crosswalk Closure Approval Request Form 734-5150 for consideration. *Alternative treatments for consideration due to unique circumstances would be coordinated with appropriate subject matter experts for approval by the State Traffic Roadway Engineer.*

Provide at least one detectable treatment when a crosswalk is closed except in circumstances where a detectable treatment is not required per the State Traffic Roadway Engineer Approval document. For example, detectable treatments may be omitted on the same side of the closed crosswalk when the only available pedestrian facility for that same side is the highway shoulder. Detectable closure treatments are typically used at a closed crosswalk where there is a

sidewalk and an intersecting pedestrian route. Detectable closure treatments include but are not limited to features such as softscape buffer strips, planted buffer strips, railings, ODOT's standard crosswalk closure support, ODOT's aluminum pedestrian fencing, or other approved treatments (see Oregon Standard Drawings). *More than one detectable treatment can be used to communicate a closed crosswalk at a given crosswalk, and it may be a different detectable treatment on each side of the closed crosswalk.*

Deviations to a detectable treatment is stipulated in the State Traffic Roadway Approval Letter and would be requested in the Crosswalk Closure Approval Request Form 734-5150 for consideration. *Alternative treatments for consideration due to unique circumstances would be coordinated with appropriate subject matter experts for approval by the State Traffic Roadway Engineer.*

Closing a crosswalk might require removal or reorientation of curb ramps. For example, a curb ramp that only serves the closed crosswalk will need to be removed. Similarly, a curb ramp that serves another crosswalk (diagonal ramp) might need to be rebuilt and reoriented to only serve the remaining crosswalk.

Attributes of Detectable Closure Treatments

Choosing the detectable crosswalk closure treatment is site-specific and generally selected for each corner based on the attributes described below. *Consult the Senior ADA Standards Engineer for new products or experimental treatments that are desired for use as the detectable treatment. Alternative treatments for consideration due to unique circumstances would be coordinated with appropriate subject matter experts for approval by the State Traffic Roadway Engineer.*

Detectable closure treatments generally:

- Contrast visually with the sidewalk.
- Are detectable and distinguishable with a white cane used by people who have limited or no vision.
- Do not have protruding edges or corners that could result in an injury to passing pedestrians or bicyclists.
- Are placed to allow at least 4 feet of clear passage for the adjacent pedestrian routes.
- Are positioned so there is not an accessible route around the treatment to access the closed crosswalk.
- Are positioned or designed to minimize the risk of tripping or missteps.
- Are crashworthy.
- Are supported by the district for maintenance.

For example, non-traversable tactile surfaces that are two feet wide or wider, such as landscaped buffer strips, are a form of detectable treatment. Aluminum pedestrian fencing also provides a clearly distinguishable detectable treatment for pedestrians that is crashworthy. Crosswalk closure supports are also a form of detectable treatment that are crash worthy.

Crosswalk closure supports are generally limited to sidewalks and other paved pedestrian areas and are generally discouraged in vegetated and unpaved areas due to a greater likelihood of being struck by maintenance equipment, obscured by vegetation, or becoming a sight obstruction for road users. The visual closure sign treatment can be a separate post and sign support installation located at the back of the walkway when the crosswalk closure support is the detectable treatment. In some locations, crosswalk closure supports can be difficult to align so they are detectable with an intersecting pedestrian route. Multiple crosswalk closure supports in a line to block the intersecting pedestrian route is not prohibited. See the Sign Policy and Guidelines for additional guidance on sign OR22-7 and the Oregon Standard Drawings for details of the crosswalk closure support.

802.6 Curb Ramp Position Need Status

The asset inventory for curb ramps is updated every six months and includes the status of curb ramps on or along the state highway system. This data is available in FACS-STIP. Questions periodically arise regarding project requirements for construction of a curb ramp when assessing the status identified on the asset layer. ODOT Curb Ramp Position Need Status Form No. 734-5390 is used for inventory status review of a curb ramp position at a specific location on or along the state highway system. Asset attribute designations for a curb ramp for a given position include In Place, Missing, Closed, or Not Needed. Older designations have been phased out. The designation for the curb ramp is based on the existing built environment and does not determine the need for a curb ramp based on construction improvements. Additions, alterations, and changes to the state highway infrastructure may change a status category for a curb ramp position after final construction.

Curb Ramp Attribute Definitions:

- In Place (IP): Ramps that have been built.
- Missing (MS): Ramp positions in which a curb ramp needs to be built or position closed by State Traffic Roadway Engineer approval.
- Closed (CL): Ramp position has been closed by official action as a part of a crosswalk closure. Ramp positions are never closed individually. Crosswalk closures require State Traffic Roadway Engineer approval.
- Not Needed (NN): No ramp is needed, based on lack of available pedestrian facilities, shoulders, or coincident crosswalks that are present.

This form is not to be used for crosswalk closure documentation. Refer to the Traffic Manual for the process on crosswalk closures.

Section 805 Pedestrian Needs

Pedestrians have different needs than vehicular traffic. Pedestrian movements and paths of travel are not as predictable as moving vehicles. Pedestrian travel is heavily dependent on human behavior and social norms rather than the rules of the road. Culturally, you may find different behavior of pedestrians when traveling in different communities or countries. People operating a motor vehicle must follow the rules of the road when driving and are generally confined to spaces demarked by lines in the roadway realm. Pedestrians are not confined to rules of the road such as striping but generally follow the path of least resistance and the shortest, most direct route to their destination. Personal choices for safety and risk taking are also dependent on the individual's abilities when using the transportation system. Refer to Section 224 and Section 900 for accommodation of other modes in design.

The Oregon Bicycle and Pedestrian plan is adopted by the Oregon Transportation Commission and is an overarching document about ODOT's vision. "In Oregon, people of all ages, incomes, and abilities can access destinations in urban and rural areas on comfortable, safe, well connected biking and walking routes. People can enjoy Oregon's scenic beauty by walking and biking on a transportation system that respects the needs of its users and their sense of safety. Bicycle and pedestrian networks are recognized as integral, interconnected elements of the Oregon transportation system that contribute to our diverse and vibrant communities and the health and quality of life enjoyed by Oregonians." ⁵ Refer to the Oregon Transportation Planning Rule (OAR 660, Division 12) policy and Section 109.7 of this manual which describes where additional pedestrian amenities, connectivity, and options for transportation are needed or required.

805.1 Americans with Disabilities Act (ADA)

The Americans with Disabilities Act (ADA) of 1990 is a Federal Civil Rights Law that mandates both the private and public sectors to make their services and facilities accessible for people with various abilities. The ADA applies to the Public Sector (State and Local Government) under Title II and Public Sector under Title III. The ADA requires that transportation facilities accommodate the needs of people with disabilities. That means sidewalks, shared use paths,

⁵ Oregon Transportation Commission's 2016 Oregon Bicycle and Pedestrian Plan.

street crossings and connections to private properties are built so people with varying abilities (e.g., limited mobility or low vision) can easily use them.

Pedestrian improvements that improve accessibility result in a high-quality system for all users. Accessible infrastructure has been linked to increased business opportunities, social development, health benefits and increased independence among community members. Accessible design benefits all users of the facility and the community. People with disabilities live in both rural and urban communities and may be more reliant on pedestrian infrastructure for transportation. People with disabilities is the largest minority group in the nation, and anyone can become a member of this population at any time during their lifetime.

The Sections in Part 805 discuss the needs of the various populations when navigating walkways. The ADA identifies disabilities based on major life activities. Disabilities protected under the ADA can be either visually apparent or unseen in the average pedestrian encounter. Disabilities might be temporary or permanent for an individual and may fall on a spectrum of affect. For example, some blind people may have some functional vision while others may be entirely without sight. Some people may have multiple disabilities on various spectrums. Human sense is how the body perceives an external stimulus and processes information which include sight, smell, hearing, taste, and touch. When one of these senses is impaired, the pedestrian must rely on the other senses to navigate their surroundings. For example, deaf-blind travelers have more difficulty navigating their surroundings as two of their primary senses are compromised.

805.1.1 ODOT ADA Transition Plan

An Americans with Disabilities Act (ADA) transition plan is a federal requirement for state transportation authorities, like ODOT, and for local governments with 50 or more employees. ODOT also requires local agencies approved in the Certified Local Agency Program ⁶ for delivery of projects with federal aid to maintain an ADA transition plan. The ODOT ADA Transition Plan is a requirement under the ADA Title II and by FHWA when receiving federal funds. The plan identifies the physical accessibility barriers that limit access to ODOT managed buildings, highways, walkways, and other facilities or services provided by ODOT. ODOT's plan describes the agency's approach to planning and prioritizing system improvements to accessibility of the state highway infrastructure. The ODOT ADA transition plan is publicly available and approved by the Oregon Transportation Commission for implementation.

Accessibility deficiencies are generally housed and identified in the ODOT FACS-STIP tool layers. Curb ramps, pushbutton activation, sidewalk accessibility, design exceptions, and CQCR's are just a few of the asset layers that can inform a team about needed accessibility

⁶ Refer to Federal Highway Administration Order 5020.2 (2014)

improvements to include in projects. Project teams will need to review the ODOT FACS-STIP tool to determine which features will need to be incorporated in the project scope of work. ADA improvements are to occur when the next opportunity arises with construction improvements, alterations, or reconstruction. The level of detail in the asset layers will vary based on information and methodology used for data collection.

ODOT's FACS-STIP Tool is a useful source of available infrastructure and accessibility data. FACS-STIP is web-based, uses GIS functions and includes both a Map Tool and a data export function when using "Data to Go." There may be pertinent data in other categories, but "Projects and Needs for Scoping" and "Roadside" together include data that should be reviewed at a minimum during scoping efforts. ODOT staff should be sure to use the internal website version to see all available data spatially on the Map Tool, to view or export reports, or to export the required reports for the 1R/3R Record of Decisions process. This process and documentation is required by FHWA and includes infrastructure conditions, including the condition of ADA-related features. ODOT's ADA Transition Plan frames up important priorities that may further guide choices when critical destinations or features are located within potential project locations.

805.2 Architectural Barriers Act (ABA)

The Architectural Barriers Act (ABA) is a Federal Law established in 1968 that mandates facilities designed, built, altered, or leased with Federal Funds are accessible and useable to people with disabilities. This includes facilities constructed on federal land on behalf of the federal agency. That means federal buildings like post offices are required to be accessible. It also includes state schools, transit centers or park-n-rides, alternative fueling stations, parks and structures built with federal funds (grants or loans). These are built so people with varying abilities can use them. Examples of facilities that are required to be accessible on state right of way or on federal land include viewing areas, rest areas, picnic tables, beach access, and trails. The ABA Standard is different than the ADA Standard; however, the dimensions, slopes and requirements are very similar or identical in many cases.

805.3 Service Animals under the ADA

Service animals are either highly trained dogs (any breed) or can be a miniature horse under the ADA.⁷ Miniature horses generally range in height from 24 inches to 34 inches measured to the shoulders and generally weigh between 70 and 100 pounds. Service animals perform tasks and

⁷ CFR Part 35 Section 35.136 Service Animals

activities that are essential to their owner's health and safety. The assistance of a trained service animal can enhance the independence, community participation and quality of life for a person with a disability. Service animals not only perform tasks related to a disability, but they are also permitted in all public places where animals are typically prohibited. Many people first think of a highly trained dog serving a blind owner as the typical service animal relationship, but many disabilities can be aided by a trained animal. A variety of dog breeds and even a miniature horse may work to support a person with a disability under the ADA. Service animals need space to walk side by side with their handler. Objects such as push buttons or levers should not be located too high so service animals can activate the mechanism when needed.

Service animals include training not only for obedience, but also public access training and specific task training. Emotional support animals (ESA) are not the same as service animals, and can be a wide variety on animals including dogs, cats, rabbits, birds, etc. Public access training involves skills to function in public places and service animals are often recognized by their calm and unobtrusive behavior with their focus on their human handler. Service animals should never show disruptive or aggressive behavior. Service dogs are most commonly recognized by helping individuals with vision impairments (low vision or blind) and those who use a manual wheelchair; however not all disabilities are visible to someone passing by.

For those with vision impairments, service animals assist their handler to safely navigate their surroundings and avoid obstacles. Service animals perform tasks including but not limited to stopping for changes in elevations such as curbs, leading a person around an obstacle such as signs, and finding entrances or exits to buildings. For those who are hard of hearing, service animals alert them to everyday sounds and emergency sounds such as a fire alarm. A hearing dog may be trained to alert them to find an audible pedestrian signal tone for example. People with limited range of motion or using wheelchairs can benefit from service dogs as well. The service animal can provide additional power to propel up a steep slope, may use their paws or nose to activate a push button, automatic door pads, or open/close lever door handles and lights. Service animals may also brace a person who has balance issues and difficulty walking.

805.4 Blind and Low Vision Users

Design pedestrian facilities so people with vision impairments can track their way safely along the sidewalk or walkway, across driveway approaches and through intersections. Keeping the walkway clear of obstructions is important. Changes to the pedestrian environment can affect their ability to orient themselves.

People with vision impairments may use a variety of aids to help them navigate their trip. They get information from sound, textures, and contrast. They benefit from audible and vibrotactile information, tactile indication of boundaries, clearly defined pathway, and high color contrasts. Some people have Orientation and Mobility instruction to familiarize themselves with frequent travel locations. People might have assistance from sighted guides including humans or

animals, telescopes, or other low-vision aids. Service animals and caning techniques aids the low vision community while navigating their environment. Many people with low vision do not use any physical aids at all when walking relying on contrasting color with their remaining functional vision. Echolocation is used by people with vision impairments in varying degrees based on the person’s abilities.

Service animals help people navigate their environment. Service animals don’t know where to go without direction from their handler. Service animals are trained to have intelligent disobedience when performing tasks, and therefore might hold steadfast if the individual is about to enter a roadway and an oncoming vehicle is approaching. Service animals can also be trained to help the individual find a vacant seat on a bus service when using public transportation.

White canes are used by people who are blind or have low vision to provide them tactile and audible information when walking. Caning techniques detect objects typically by sweeping a cane ahead from side to side. Typically, a person sweeps a cane about 3 feet wide and paces forward about 2 feet during the cane sweep with each step. Objects lower to the ground allow for early detection with a cane and allow for greater perception and reaction time. A white cane is intended to detect objects up to 27 inches above ground. Objects above 27 inches that are not detected that protrude in the pedestrian circulation area can cause physical harm or bodily injury to a person’s internal organs when their body strikes it. Objects below 80 inches that protrude in the pedestrian circulation area can also cause injury to the head and eyes if adequate vertical clearance or detectable delineation is not provided.

Figure 800-1: Width Requirement for Person with Crutches and for White Cane User

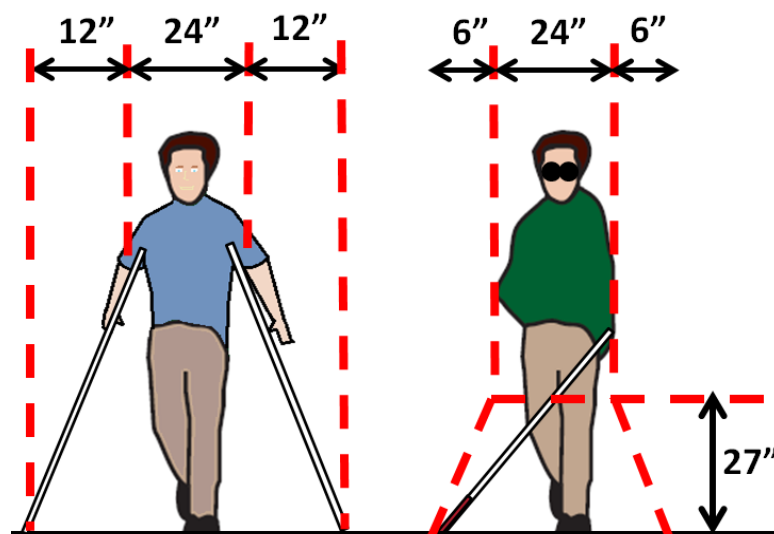

Installation of detectable treatments and tactile walking surface indicators (TWSI) provide useful cues for the low vision community to navigate their way along sidewalks and shared use paths. Detectable treatments include physical edged features such as curbing, landscape

materials, fencing, concrete barrier, or similar features. Landscaping can be divided into both hard and soft features. Confusion can occur with a landscape feature that cannot be distinguished underfoot when that area is not intended to be walked on.

Tactile walking surface indicators provide information under foot that can be perceived wearing shoes but does not impede mobility devices from traversing over them. Tactile walking surface indicators are the equivalent to braille underfoot. There are different geometric shapes for TWSI with emerging use in the USA. Truncated dome warning surface panels are one style of TWSI used on pedestrian facilities in the public right of way. FHWA requires the installation of truncated dome detectable warning surfaces (DWS) on federally funded projects at curb ramps. Detectable warning surfaces are required at railroad pedestrian crossings, and at transit service areas designating the boarding and alighting areas. For information on the installation location of DWS, refer to the latest Oregon Standard Drawings.

Provide “safety” yellow detectable warning surfaces at curb ramps, railroad crossings and at transit stops. When detectable warning surfaces are detected underfoot or by cane, the user should be alerted to stop. Detectable warning surfaces are intended to communicate a “stop” message of where the vertical curb line no longer exists (flush connection with the roadway). Detectable warning surfaces are not intended to provide orientation information about the path of travel in the United States with the truncated domes pattern. While stopped, the DWS is an attention pattern that informs the user to evaluate their surroundings. The user will decide when to proceed with the crossing, or to remain stopped and wait to board a transit service. Detectable warning surface colors that are in high contrast with the surrounding area identify the location of curb ramp openings for people who have some functional vision remaining (low vision).

Tactile information is helpful both underfoot and with hand placement on objects. Pushbuttons for signals provide a vibrotactile indicator when the hand rests on the push button and the indicator changes to a walk condition. The arrow symbol on the push button is also a raised symbol so someone feels which direction the arrow is pointing. These are strategies used for effective communication at signals as stipulated under the ADA.

805.5 Users of Mobility Aid Devices

Many people have physical impairments for a short time, while others live with physical limitations their whole lives. As a result, there is a wide range of operational ability between people. Many people with physical disabilities use assistive devices such as crutches, canes, walkers, scooters, and wheelchairs. Others have prosthetic limbs or healing injuries that impact their ability to walk. As a result, they have limited agility, speed, and endurance. Other people with heart disease or otherwise limited stamina prefer stairs to a longer route with a gentle slope. Lips, curbs, and stairs are barriers for many people, requiring sloped ramps as an alternative on the walkway.

People with physical impairments benefit from firm, level surfaces, adequate clear width, and limited cross slope. Adequate space is needed to use mobility aid devices on walkways. Pedestrians with mobility impairments are more sensitive to time limits that depend on walking speed. Walking speeds typically vary from 2.5 to 6.0 feet per second by foot, while powered devices can travel up to 10 mph. Walking is slower near intersections and when pedestrians are in groups rather than walking alone. Refer to the traffic signal manual for walking design speed in traffic operations.

There are many styles of wheelchairs including those requiring another person to push from behind, self-propelled manually, power assisted and motorized wheelchairs. Since they are sensitive to grades, some are equipped with safety wheels to help prevent tipping over backwards. Manually propelled devices may have aftermarket devices installed to provide power assistance when negotiating steep terrain periodically. Motorized wheelchairs and scooters are most impacted by space availability for turning maneuvers. Users are sensitive to imperfections in the ground surface that may vibrate when they roll. Clear space requirements for a common wheelchair are 48 inches in length and 30 inches wide. Many devices including power assisted scooter today are larger and occupy a physical space of 5 feet in length. Wheels on the device are typically 2 feet apart.

Service animals help those with mobility issues in performing tasks such as opening or closing a door, delivering or carrying an object, and providing power to physically move or brace the handler. Light duty service animal tasks include guiding or light pulling in a forward direction. Moderate duty service animal mobility tasks include acting as a counterbalance for walking in partnership with their handler or bearing weight for a person to stand or navigate stairs. Heavy-duty service animal mobility tasks include pulling a person seated in a wheelchair. Miniature horses are physically able to perform heavy duty pulling more frequently in comparison to a service dog (depending on breed).

Figure 800-2: Illustration of Variety of Wheelchairs



805.6 Deaf and Hard of Hearing

People who are deaf, or hard of hearing rely more on their vision but may also use tactile information. They benefit from good sight lines for assessing street crossing conditions and information in visual or vibrotactile format, and walkways that are free of obstacles. They may be more sensitive to the information provided by textures they walk over. The high contrast color of the detectable warning panel and texture underfoot of the truncated domes may also alert someone that is deaf or hard of hearing that they are about to enter a street crossing. Count down signal heads provide information for deaf and hard of hearing individuals visually so they can prepare to cross the street.

While most people think of service dogs being used for blind travelers, service dogs can also be trained to aid those who are deaf or hard of hearing, and alert them when certain sounds or words occur. Hearing service animals might be trained to assist the handler find the locator tone on the pushbutton, or alert them to an emergency alarm, or alert them when they drop an object such as keys. At signalized intersections a service animal may be trained on the verbal command to stay in place with the word “wait” until they are released by their handler’s cue. Audible cues such as the repeated word “wait”, or percussive tones when the pushbutton is

activated could be heard by the service animal to inform their handler when “walk” time is available.

805.7 Cognitive Conditions

Disabilities involving cognition, learning and memory affect the ability for people to perceive and react to information in the surrounding pedestrian environment. Responding to a traffic control device, such as a walk signal requires a perception and reaction time, typically up to 3 seconds before proceeding. People who use mobility devices can require up to 20 feet to react and stop walking equating to a stopping sight distance need for vehicles.

Features in the pedestrian environment that can affect the ability to travel include interpreting traffic signs, actuating a pedestrian signal, understanding the configuration of a street crossing, changing directions and predicting traffic movements. Individuals benefit from straightforward signs with easy to understand picture symbols, reliable wayfinding, consistency between the placement of curb ramps, pushbuttons and other features, direct and uncomplicated street crossing geometry, good sight distance at crossings and otherwise thoughtful design and operation.

Section 810 Walkways

Sidewalks are a portion of the public right of way located in the Pedestrian Realm used for the locomotion of pedestrians. The Pedestrian Realm is divided into the Buffer Zone, Pedestrian Zone, and the Frontage Zone. Recreational and transportation needs of pedestrians can be served by walkways. Walkways include sidewalk, pedestrian lanes, shared use path, and trails. Paved shoulders serve pedestrians using rural highways in the absence of sidewalk in the Travelway Realm. Street crossings or crosswalks serve pedestrians connecting sidewalks across the Travelway Realm by providing a pedestrian access route in the roadway.

Provide sidewalks in all Urban Contexts on state highways. Per ORS 366.514, walkways and bikeways must be provided whenever a roadway is “constructed, reconstructed, or relocated.” Refer to Section 900 for more discussion on the “Bike Bill”. A sidewalk is a facility or service to provide people with transportation options. *Limited access expressways should be evaluated for a possible exception, providing a shared use path or separated bikeway along a parallel route.* If walkways are provided, then they are required to be accessible and usable by a person with a disability under the ADA. For people with disabilities, the public walkway may be their only option that they can use independently. Refer to Section 805 for pedestrian needs.

When walkways are constructed, they are required to meet ADA requirements. Provide an accessible sloped entrance and exit to transition from the walkway to the shoulder when the facility terminates. Entrance and exits are typically made with curb ramps that cut through a

curb along the roadway, located most often at crosswalks which are extensions of the sidewalk. See Section 815 for the requirements of curb ramp design. Entrance and exits connecting the walkway to the paved surface of the shoulder or roadway can also be at grade (without curbing).

Pedestrian facilities with a Buffer Zone are the preferred facility for pedestrians. Walkways may be separated by a buffer which can include but is not limited to a ditch, landscaping area, rain garden, curb, guardrail, or other barrier. The buffer treatment makes a physical separation from vehicular use and the walkway surface constructed becomes exclusive for pedestrian use.

Sidewalks and shared use paths may be needed on state highways beyond city limits based on existing and planned land use within the urban growth boundary, or in unincorporated areas. **Projects are not permitted to degrade existing sidewalks per the Oregon Bicycle and Pedestrian Plan Strategy 3.2F. Modifications and reconstruction of walkways shall not reduce accessibility under the ADA.** This means the final construction conditions cannot be made worse for pedestrians with any given modification to the walkway. Consult the Regional Planner for planning documents including but not limited to Transportation System Plans for planned pedestrian network improvements in communities. New sidewalk construction or infill needs can also be determined through roadside inventory data via the FACS-STIP tool and from local planning documents. See Appendix F, FACS-STIP Tool Guide for instructions on how to access roadside inventory sidewalk need data through the FACS-STIP tools.

Sidewalks, shared use paths and pedestrian lanes located along roadways shall have a firm, stable, and slip resistance surface. Walkways can be constructed of many materials and meet the accessibility requirements (see Section 810.8 Walkway Surfaces) required by ADA. Sidewalks can also be used by bicyclists, but cities may ban bicycle riding on sidewalks with a local ordinance.

Shared Use Paths (Multi-Use) are typically used by pedestrians, cyclists, skaters, joggers, and users of other micro mobility devices. It is not realistic to plan and design a pathway for exclusive use, as other modes will be attracted to the facility. Shared Use Paths may reside parallel with the highway or have a separate alignment that leaves the highway right of way connecting destinations and recreational areas within the community. **Shared Use Paths are required to be accessible for the full width of the facility meeting surface, cross slope and running slope requirements under ADA. Accessible sloped entrances and exits shall be provided where the shared use path ends, serves a crosswalk, or crosses a curb.** See Part 900 and Part 845 for additional shared use path design guidelines.

Figure 800-3: Sidewalks in Urban and Suburban Contexts



Figure 800-4: Shared Use Path on Separate Alignment from Travelway Realm



A trail is defined as a pedestrian route developed primarily for outdoor recreational purposes. Pedestrian routes that are developed primarily to connect accessible elements, spaces, and buildings within a site are not a trail. **Trails are required to be constructed of a firm and stable surface material.** “A firm trail surface resists deformation by indentations. A stable trail surface is not permanently affected by expected weather conditions and can sustain normal wear and

tear from the expected uses between planned maintenances”.⁸ Providing a higher level of accessibility in surface material construction or other pedestrian access route requirements is not prohibited on trail systems. *Signs at the trailhead indicating the trails accessibility features such as steepness and distance is encouraged to provide information for users about the trail facility.*

Trails may be unpaved (packed gravel) if they are graded and firm (resist indentation). An unpaved path may not be constructed in lieu of sidewalk. ADA requirements for trails are not intended to change the overall experience of the trail, but to provide useable access to the recreational feature and facility to people with disabilities. ADA requirements for trails are different from walkways that are used for transportation purposes (sidewalks, pedestrian lanes, and shared use paths). Trails may be designated for exclusive use by a mode of travel such as by horseback.

Figure 800-5: Trailhead and Trail in Recreational Context.



Shoulders serve pedestrians where a walking facility is not provided. The shoulder is shared for vehicle recovery area, bicyclist travel and pedestrian usage. Oregon law ORS 814.010 requires

⁸ US Access Board 2014, “A Summary of Accessibility Standards for Outdoor Developed Areas”

that pedestrians who walk along a shoulder face traffic, while sidewalks serve both directions of travel. Mobility devices, power assisted wheelchairs and scooters are permitted to utilize the shoulder rather than the sidewalk under Oregon law (ORS 814.500 and 814.510) and should be traveling with the flow of traffic. See shoulder width table in Part 300 for shoulder width guidelines.

Figure 800-6: End of Pedestrian Exclusive Facilities



When roadway shoulders include pavement markings or signs that indicate the shoulder is intended for pedestrian use only, the shoulder becomes an exclusive pedestrian facility requiring the accessible route standards to be met under ADA. See Section 810.7 for more discussion on pedestrian lanes.

810.1 The Pedestrian Realm

A highway cross section is categorized into Realms as described in Part 300. The Pedestrian Realm is further divided into four zones. These include the Curb Zone, the Buffer Zone, the Pedestrian Zone, and the Frontage Zone. The Pedestrian Realm is adjacent to the Transition Realm. The best way to achieve the goal of a clear walking area is to design pedestrian facilities using the zone system. Each zone is a distinct area. Each zone has its function, and omitting a zone compromises the quality of the walking experience.

On highways with separated bike lanes, the Curb Zone and Buffer Zone may overlap zones within the Transition Realm. See Part 300 for design requirements in the Cross Section Realms. Roadway facilities should be designed and operated to enable safe access for all users, including pedestrians, bicyclists, motorists, and transit riders of all ages and abilities. The Pedestrian Realm serves pedestrians and provides access to the land uses. Understanding the pedestrian

activity, access to land use, and buffers in this realm can help prioritize the design decisions in the pedestrian realm and support the need to balance the trade-offs amongst the various cross section constraints.

810.2 Curb Zone

Most urban streets with sidewalks are typically curbed. A curb channelizes storm water to a storm water treatment facility and waterway, provides edge delineation from the vehicular or bikeway facilities, and discourages people from parking their cars on the sidewalk. Curbing also provides visual or tactile information to pedestrians. There are several styles of curb including those with a vertical edge, a sloped surface, or a rolled edge. Curbing may also include a concrete gutter pan (apron) to provide additional hydraulic capacity conveyance, control slope construction at a crosswalk, and provide a solid edge for pavement construction and inlays. The Curb Zone is also where a sidewalk transitions to the street at a crosswalk or intersection. Refer to Part 300, Section 317 Curbs for curb type selection and uses on state highways.

Figure 800-7: Curb Zone Transition from the Street to Sidewalk

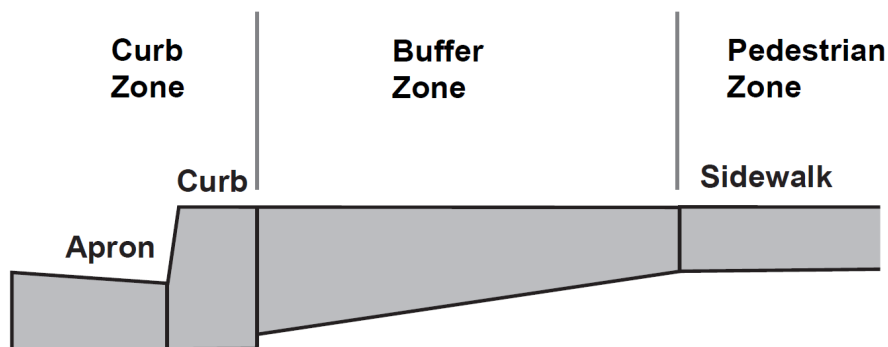

*Provide a Curb Zone within the range of 2.5 feet to 6 inches, see RD700's. Curb Zones less than 6 inches are rare and do not follow ODOT's standards for construction per RD700. Drainage curbs as shown in RD701 are generally not the preferred option for the Curb Zone when creating pedestrian walkways (see discussion on pedestrian lanes in Section 810.7). Where curb and gutter is used and on-street parking is provided the gutter pan surface is included in the parking dimension. Where located next to a travel lane and directly adjacent to curb, the gutter pan surface is included in travel lane measurement. **Provide a smooth, flush transition from gutter pan to roadway surface.***

The Curb Zone introduces a physical barrier for pedestrians with some disabilities and can obstruct a person from entering or exiting the pedestrian facility or walkway. **A curb ramp is required to provide access (entrances and exits) to the pedestrian facility including sidewalk and shared use paths.** The curb is typically modified to be depressed and flush with the

adjacent surfaces along the pedestrian access route on the walkway. Refer to Section 815 for curb ramp design and curb running slope requirements. Curb and gutter is a part of the curb ramp system. For splitter islands or other accessible route islands where the curbing (Curb Zone) is keyed into the pavement construction, curb and gutter is required as shown on RD710. The curb ramp standard drawing series RD900s have a basic assumption that the sidewalk is or will be a curbed typical section. A snow curb return design may be used (see Section 815.4.11). When the adjacent surface material for a separated bike lane is constructed of Portland Cement Concrete for the full width at the crosswalk, a curb and gutter can be omitted in the separated bike lane (See RD702). Curb and gutter may be integrated into the bridge deck or PCC pavement cross section when needed.

Many rural locations do not have existing curb in place for the highway cross section and will remain rural in character with separation from the Travelway Realm (for example a grassy sloped surface or ditch buffer). The same basic requirements for slopes and grade apply to the sidewalk and connections to the crosswalk for the pedestrian access route in these circumstances. *When sidewalks do not include curbing (Curb Zone), curb and gutter is not required for the pedestrian ramp (see section 815 for definition). When there is no Curb Zone, the surfaces adjacent to each other must be flush and meet the slope requirements for the pedestrian access route at the pedestrian ramp.*

810.3 Buffer Zone

The Buffer Zone is also known as the Furniture Zone or Furnishing Zone. On highways with separated bike lanes, zones within the Transition Realm may overlap zones in the Pedestrian Realm. All walkways should be designed so that a buffer distance separates the Pedestrian Zone from traffic, unless right of way or other constraints preclude this feature. Buffers may include a planted buffer strip, a shoulder barrier, a parking lane, or a bike lane. Refer to standard drawings RD700 series for additional construction details. See Part 300 for Cross Section Realm design guidance.

While ranges can vary for the Buffer Zone, start with the largest width feasible during design based on the Urban Context. Larger Buffer Zones are not prohibited. *Provide a Buffer Zone within the range of 6 feet to zero feet in the Traditional Downtown/Central Business District, Urban Mix, Suburban Fringe and Residential Contexts. Provide a Buffer Zone within the range of 5 feet to zero feet in the Commercial Corridor and Rural Community contexts.*

Provide a continuous buffered sidewalk in Commercial, Residential, Suburban and Rural Community Contexts of at least 2 feet. A minimum 3-foot buffer zone is required along the circulatory portions of a roundabout in any context (urban or rural), see RD170. Recommended set back widths should be 5 feet for roundabouts. The Buffer Zone in roundabouts directs pedestrians to the crosswalk. See Section 509 for roundabout design requirements. Where constraints preclude the use of a buffer throughout a project, it can be interrupted and then resumed where

the constraint ends with gradual transitions. The traveling speed of pedestrians and the mobility devices can vary up to 10 mph in the walkway (walking, running, or operating a mobility device) with average walking speeds of 3.0 mph. Transitions rates used for horizontal width changes takes into consideration the traveling speeds of pedestrians. *Transitions rates for horizontal width changes in the Pedestrian Zone or walkway is preferred to be 1:10. When space is constrained a transition rate of 1:5 is permitted. A transition rate of 1:3 is the minimum requirement for horizontal width changes.*

Figure 800-8: Buffer Zone Used for Signs, Utilities, and Decorative Plantings

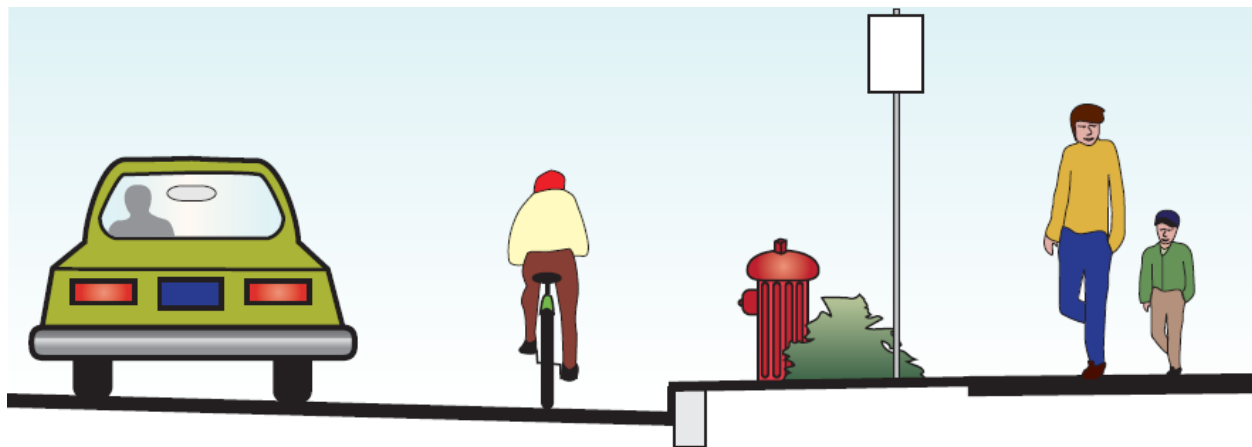

A buffer strip should be at least 4 feet wide when planted landscaping is desired. Areas less than 12 square feet are difficult to support plant growth. Continuous planted buffers are not recommended in downtown areas with on-street parking because this precludes direct access to the sidewalk at the arrival point (parking space) and limits the use for people with disabilities. Plantings should be selected based on regional conditions. Select varieties of plant species that require little maintenance and watering, and their roots should not buckle walkways. **Ornamental plantings are not permitted per the DES 20-01 policy without an agreement for maintenance in place with the local agency.** See discussion on walkway surface selection in Section 810.8.

Figure 800-9: Landscaping Providing Storm Water Treatment



Provide a Buffer Zone at least 2.0 feet adjacent to parking so cars do not reduce the Pedestrian Zone and pedestrian access route. Parked cars encroach into the walkway because there is an overhang distance from the wheels or side mirrors from either perpendicular or parallel parking. *A paved Buffer Zone adjacent to parallel on-street parking spaces increases usability by providing boarding and alighting areas for accessible van ramps and mobility devices to the walkway when there isn't room for an access aisle.* Provide anchored (pinned) wheel stops, curbing or other treatments to prevent narrowing of the Pedestrian Zone from vehicular overhang. The amount of encroachment for head in parking in comparison to back in parking is significant (particularly trucks). Cars parked head in on a perpendicular or diagonal alignment encroach a smaller distance into the walkway. When angle parking is provided check the overhang distance based on AASHTO's parking lane configurations.

Figure 800-10: Wheel Stops Reduce Sidewalk Encroachment

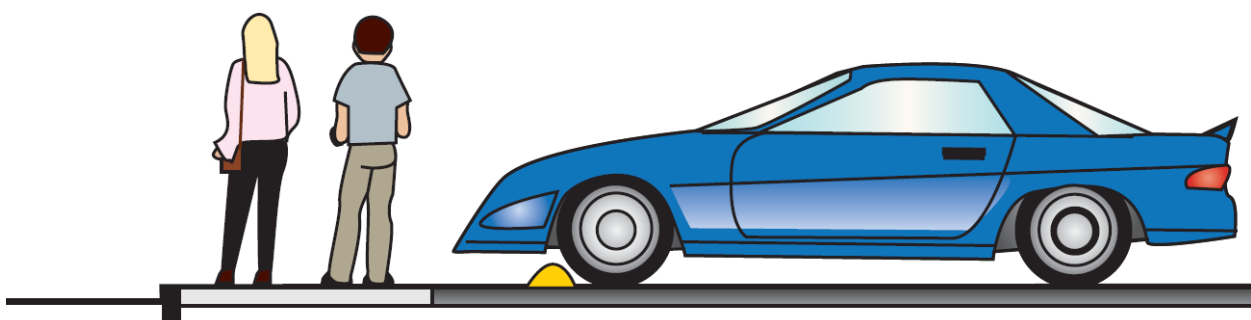

Pedestrian amenities are services provided to the public. **Provide a pedestrian access route in the Buffer Zone or furniture zone to pedestrian amenities so all people can access the services provided.** See discussion on pedestrian amenities in Section 810.10 and the pedestrian access route in Section 810.5. The Pedestrian Realm should be widened to create a Buffer Zone for street furniture and other amenities out of the Pedestrian Zone. Benefits of the furniture

zone for pedestrians and other road users are discussed in Appendix L, Oregon Bicycle and Pedestrian Design Guide, pages 4-2 to 4-3. Trees, street furniture and other objects should not reduce visibility of pedestrians, bicyclists, and traffic signs, especially at intersections.

810.4 Pedestrian Zone

The Pedestrian Zone is where people walk and is free of obstructions. All planning, design, and construction documents (including permits) should clearly state the Pedestrian Zone dimension is to be clear of all obstructions. The Pedestrian Zone overlaps the same space as the pedestrian access route. The zone system makes it easier to meet the basic ADA requirements for a continuous, smooth, level sidewalk free of obstructions. Provide room for permanent obstructions such as street furniture, lighting, signs and utilities in the Buffer Zone or Frontage Zone. When the Pedestrian Zone is separated from the roadway with a Buffer Zone (furniture zone), pedestrians are further from traffic, increasing comfort and security when walking.

Figure 800-11: The Pedestrian Realm Zone System in the Urban Context

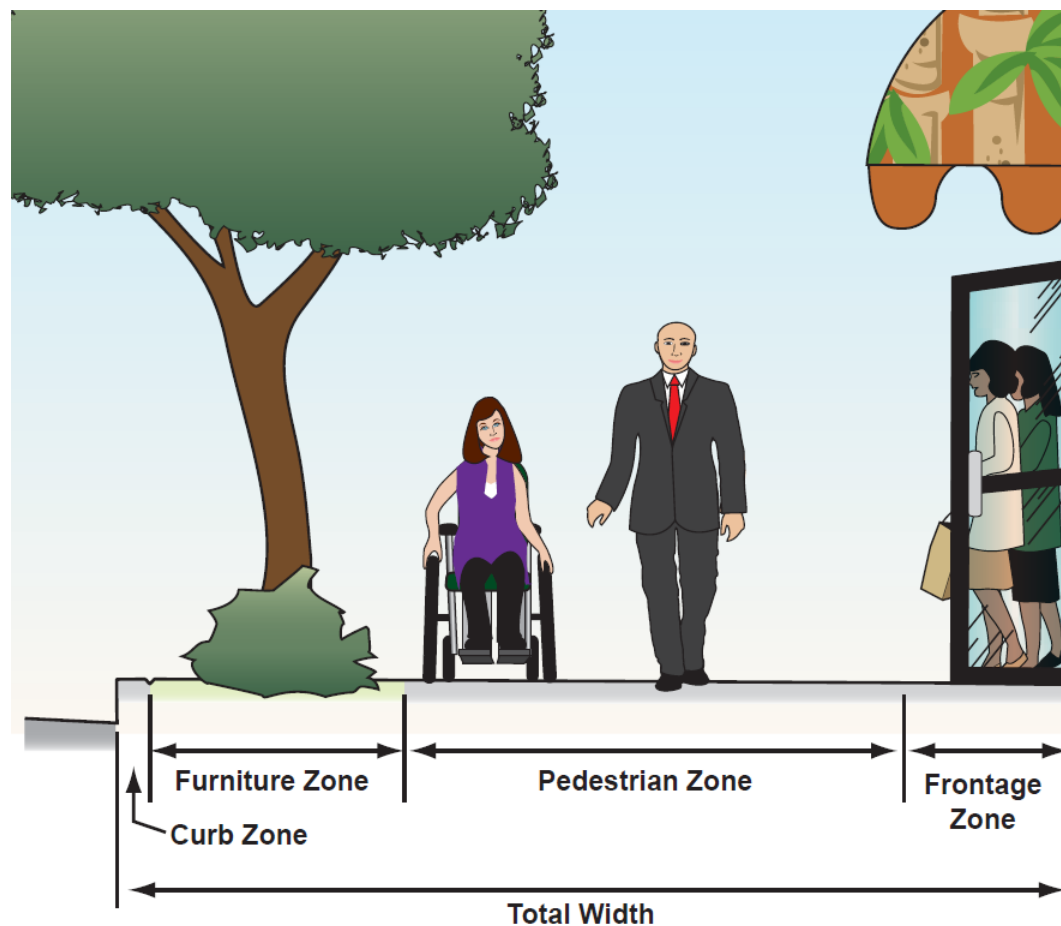

The Pedestrian Zone can take on different configurations within the Pedestrian Realm and based on the six Urban Contexts. ODOT’s Urban Contexts include Traditional Downtown/Central Business Districts, Urban Mix, Commercial Corridor, Residential Corridor, Suburban Fringe, and Rural Community. Refer to Part 200 for more discussion on the Urban Context and classification identification process. Roadway design has been rapidly changing toward greater flexibility along with inclusion of multimodal, context related design focusing on all road users. Modal considerations are given higher priorities depending on the Urban Context.

Pedestrian facilities can include sidewalks with or without curbs, behind a ditch or on a bridge to provide pedestrian transportation. Sidewalks are designed for preferential or exclusive use by pedestrians. Provide ample space for pedestrian activity in Traditional Downtown/Central Business Districts and Urban Mix areas including but not limited to outdoor dining and transit shelters. Select a walkway width with sufficient space to accommodate desired level of pedestrian activity.

Walkway widths are exclusive of curbing. The curb is a part of the Curb Zone. ***Provide a Pedestrian Zone with the width in the range listed in Table 800-2: Pedestrian Zone Design Range below, however larger widths are not prohibited. A design exception is required for the Pedestrian Zone if the width falls below the smallest dimension in the range in Table 800-2: Pedestrian Zone Design Range. At least 5 feet of the Pedestrian Zone will be continuous meeting pedestrian accessible route requirements. Best practice is to keep the pedestrian zone straight and continuous, rather than meandering between fixed objects or zoned areas. Providing a fully accessible Pedestrian Zone is best practice to allow flexibility for future installation of pedestrian amenities.***

Figure 800-12: Sidewalk with a Clear Pedestrian Zone



Design the Pedestrian Zone with the greatest width feasible within the design range, starting with the largest width. The Pedestrian Zone is free of obstructions, utilizing the Buffer Zone for lighting, signs, and boarding and alighting areas. The Frontage Zone contains decorative planting boxes and other pedestrian amenities. **A 5-foot Pedestrian Zone requires a 1-foot paved Frontage Zone or a paved Buffer Zone, so the minimum “walkable” surface width is 6 feet.**

Table 800-2: Pedestrian Zone Design Range

Traditional Downtown/CBD	Urban Mix	Commercial Corridor	Residential Corridor	Suburban Fringe	Rural Community
10 ft to 8 ft	8 ft to 5 ft	8 ft to 5 ft	8 ft to 5 ft	8 ft to 5 ft	9 ft to 5 ft

A 6-foot wide Pedestrian Zone allows two people (including wheelchair users) to walk side by side, or to pass each other comfortably as pedestrians are permitted to walk in either direction on a sidewalk. Six-foot widths also allow two pedestrians to pass a third person without leaving the walkway. **Where it can be justified and deemed appropriate, the minimum width of a sidewalk may be 60 inches (5 feet).** Locations where it may be justified to provide minimal facilities include local streets or where there are physical constraints. A design exception is not required on a local road if 5 feet is the road authorities standard. Coordination with the local road authority is required as some local road authorities have a wider standard for sidewalks or identified in their Transportation System Plan. *When designing a 5-foot sidewalk, include a margin for error by stipulating an additional 2 inches in your design for construction to ensure the ADA passing requirement is met; ADA requires 60 inches minimum final construction passing width to be compliant with the regulations for the pedestrian access route.* Physical constraints might include a building foundation, a historic wall or building, or utility poles.

Figure 800-13: 5-Foot Sidewalk is Uncomfortably Narrow



810.5 Pedestrian Access Routes

The fundamental ADA requirement is to create a contiguous link between site arrival and site destination points that is accessible by all people. This link is called the pedestrian access route and is a portion of a Pedestrian Zone that meets ADA requirements. Pedestrian access routes allow for access unassisted by others to a destination. Pedestrian access routes (PAR) lie within the Pedestrian Realm or pedestrian circulation areas. The Pedestrian Realm can be considered a pedestrian circulation area(s) while only a portion of that surface in the Pedestrian Realm may be the pedestrian access route.

Design at least a 60-inch pedestrian access route that is fully accessible meeting ADA requirements. *Both the Pedestrian Zone and pedestrian circulation areas should be fully accessible; the Pedestrian Zone and pedestrian access route should be of equal width.* Driveways are designed with a narrower pedestrian access route to allow vehicular entry into the private property when right of way is constrained.

Pedestrian circulation areas include all hard surfaces that are walkable and contiguous with the Pedestrian Zone including the Buffer Zone (furnishing zone) and Frontage Zone. **Pedestrian circulation areas are constructed flush adjacent to the Pedestrian Zone and pedestrian access route.** Softscaping elements included in the Buffer Zone such as planted beds, grass, loose rock, and bark mulch are not considered walkable for all people and define the boundaries of where the intended pedestrian facility resides. Softscaping provides cues with natural materials with sound, texture, and contrast that is different than the walkable surface. Softscaping provides a more pleasant pedestrian experience when walking and enhances the community character. Able-bodied pedestrians might be able to traverse them, however softscaping materials are not accessible surfaces. Accessible surfaces must be firm, stable and slip resistant under the ADA year-round.

Fixed objects that reside in the Pedestrian Realm reduce the useable sidewalk width and effective Pedestrian Zone width. Temporary objects must not block the pedestrian access route. These items might include trash cans, advertising sandwich boards (A frame), feather flag signs, rental bikes, or rental scooters. Select Buffer Zones and Frontage Zones widths that can accommodate these types of amenities for intermittent periods of time without blocking the pedestrian access route.

ADA requires wheelchair passing opportunities on pedestrian facilities; constructing a 60-inch (5 feet) pedestrian access route in the walkway free of all vertical obstructions ensures that standard is met without further analysis (See RD 720). *When designing a 5-foot sidewalk, include a margin for error by stipulating an additional 2 inches in your design for construction to ensure the ADA passing requirement is met; ADA requires 60-inch x 60-inch minimum passing space to be compliant for the pedestrian access route.* **At no point shall the Pedestrian Zone or pedestrian access route be less than 48 inches (4 feet) wide at pinch points; passing opportunities and distances will need to be analyzed. In very constrained areas, such as around obstacles that cannot be**

moved, a minimum passage of 48 inches (4 feet) for the pedestrian access route must be maintained for a maximum length of 200 feet.

The pedestrian access route shall have a smooth surface, free of vertical discontinuities, free of large horizontal openings and be clear of utility poles, signs, signal poles, trees, and other obstructions. The cross slope of a pedestrian access route may not exceed 2.0 percent at finished construction. *The pedestrian access route is generally designed within the range of 0.5 percent to 1.5 percent cross slope to provide drainage.* The balance of the sidewalk width can be used to make up grade differences, if necessary, with cross slopes exceeding 1.5 percent to match into adjacent existing built constraints in either the Buffer Zone or Frontage Zone keeping vehicular Clear Zone in mind. See Section 400 for Clear Zone requirements. **Provide a vertical clearance at least 7 feet (84 inches) to vertical obstructions (e.g., bottom edges of signs, tree limbs, pedestrian signal heads, etc.) in all walkways and pedestrian circulation areas.**

Figure 800-14: Walkway Vertical Clearance

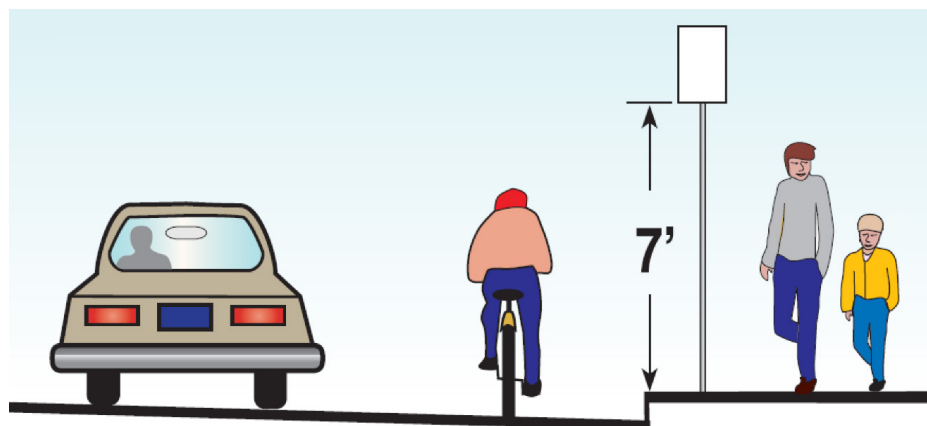

Crosswalks reside in the Travelway Realm and are extensions of the pedestrian access route connecting sidewalks. See Section 802 for Crosswalk Location Determinations and the Traffic Manual for where crosswalks exist on or along the State Highway. Pedestrian access route design width requirements vary at intersection corners with curb ramps or at midblock crosswalks. See Oregon Standard Drawings RD900 series for detailed curb ramp construction drawings, and Section 815 for curb ramp design information. Refer to Section 820 for discussion on accessible routes and building ramps to public entrances.

810.5.1 Protruding Objects

ADA requires that objects protruding from walls (e.g., signs, fixtures, telephones, canopies, street art) are placed so their edge is not more than 4 inches from the wall or other cane detectable edge when the height of the object is between 27 inches and 80 inches above the finished walkway for any portion of the public walkway (See RD 720). This requirement is

applicable to moveable or temporary objects in the walkway. Routine maintenance is needed for tree canopies or vegetation that overlap the walkway as they are often overgrown and become a protruding object.

Protruding objects present a hazard in the walkway to pedestrians, particularly the low vision and blind community. However protruding objects are also a problem for a person sitting in a wheelchair. For example, when the object is at eye height and in the walkway or pedestrian circulation area, people with paralysis may not be able to move their head out of the way of that object. Protruding objects restrict the available and useable walkway space for pedestrians to circulate or congregate. These types of objects, facilities, and services (e.g., water fountains, telephones, street art, trash cans, signs, decorative planter boxes, etc.), and amenities must be placed in the Buffer Zone or Frontage Zone and not in the Pedestrian Zone.

Mailboxes are a common protruding object in sidewalks along the state highway. When projects include a Buffer Zone that is constructed with plantings and softscape materials, this can provide natural edge detection around the mailbox installation for low vision or blind travelers. Drainage curbing can provide the detectable edging necessary for white cane detection around a mailbox, however it is not the best practice. Drainage curbing on sidewalks introduces added complexity and considerations for storm water runoff. Drainage curbs used as detectable edge delineation around a mailbox impacts the Clear Zone functionality and thoughtful selection of end treatments such as a curb ending may be needed.

810.5.2 Temporary Pedestrian Access Routes

The temporary pedestrian access route (TPAR) details how pedestrians will be directed through or around a construction work zone. The level of detail required for the TPAR depends on the complexity of the project and the volume of pedestrian traffic. Accessible route design criteria is similar to the permanent pedestrian access route, however, the guidance for TPAR design is provided in the Traffic Control Plans Design Manual. **TPAR design ensures the pedestrian has a facility that is at least equivalent or better than the pedestrian facility that was in place prior to construction starting.** Site destinations such as a business entrance access must be maintained from the TPAR. *Refer to MG Activities 2 Highway Division Maintenance Operational Notice for temporary pedestrian access route plan requirements during maintenance work.*

810.5.3 Walkways on Bridges

Coordination with the structural or bridge designer is required to ensure the walkway on a bridge is fully accessible. Details showing the walkway surface connection at the bridge rail and details of the expansion joints is typically required. **Ensure a slip resistance surfacing is installed on the walkway at the bridge joint or joint cover plate.** *Transitions over the joint or*

plate should be designed flush as there cannot be a vertical change exceeding ¼ inch in the pedestrian access route. Grout railing pads, decorative lighting, guardrail posts, and bridge rail connections often reduce the clear width of the pedestrian access route and pedestrian zone. **A 1-foot pedestrian shy distance is needed from each concrete barrier and/or pedestrian railings on walkways constructed on bridges.**

810.6 Frontage Zone

The Frontage Zone is located between the Pedestrian Zone and the private right of way. It is where sandwich boards, kiosks, bike racks and other street furniture can be placed. It is used by window shoppers and for outdoor dining when permitted by the road authority. *Refer to Delivery and Operations Division Operation Notice MG14-04 for permit requirements on ODOT facilities where portions of the sidewalk are closed.* The Frontage Zone is where people enter and exit buildings. Business frontage doors typically swing outward from the building to ensure Fire, Life and Safety egress can occur; the doorway maybe recessed from the exterior building face. **Provide a pedestrian access route to site arrival points and destinations that are available to the public.** These include pedestrian amenities but are not limited to doorways, kiosks, pay stations, water fountains, benches, parklets and transit shelters.

Provide a Frontage Zone that ranges from 4 feet to 2 feet in traditional downtown/central business districts. In Central Business Districts the Frontage Zone should be 4 feet or wider to provide space for merchandise, sidewalk cafés, and opening business doors, and adjacent parking lots. A 2-foot pedestrian shy distance is needed from vertical barriers such as buildings, sound walls, retaining walls and fences.

Figure 800-15: Generous Frontage Zone with Seating and Bus Shelter



Provide a Frontage Zone at least 2.0 feet adjacent to parking on private right of way so cars do not reduce the Pedestrian Zone and pedestrian access route. Parked cars encroach into the walkway because there is an overhang distance from the wheels or side mirrors from either perpendicular or parallel parking. Provide anchored (pinned) wheel stops, curbing or other treatments to prevent narrowing of the Pedestrian Zone from vehicular overhang. The amount of encroachment for head in parking in comparison to back in parking is significant (particularly trucks). Cars parked head in on a perpendicular or diagonal alignment encroach a smaller distance into the walkway. When angle parking is provided check the overhang distance based on AASHTO’s parking lane configurations.

Figure 800-16: Wheel Stops Reduce Sidewalk Encroachment

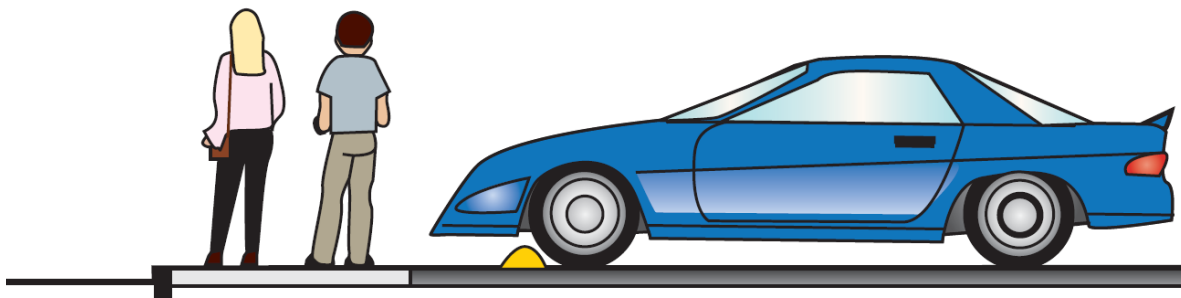

Provide a Frontage Zone that is at least 1 foot in all Urban Contexts. When the Pedestrian Zone is only 5 feet wide, the Frontage Zone will need to be a hard surface (paved or concrete), see discussion in the Section 804.4 Pedestrian Zone. The width of the Frontage Zone

provides space so there is not encroachment onto public property with permanent objects such as fencing. The space provides maintenance personnel the room to make repairs to sidewalk.

810.7 Walkway Configurations

The Pedestrian Realm width is the summation of the Buffer Zone, the Pedestrian Zone, and Frontage Zone. Configurations for sidewalks vary based on the Urban Context and may require greater widths. The Oregon Highway Plan is a statewide planning and policy document for Oregon with requirements for sidewalks related to highway designations defined in that statewide policy document.

The Oregon Highway Plan (OHP) is a modal element of the Oregon Transportation Plan (OTP). The OHP addresses efficient management of the system to increase safety, preserve the system, and extend its capacity; increased partnerships, particularly with local and regional governments; links between land use and transportation; access management; links with other transportation modes; and environmental and scenic resources. The OHP also establishes a variety of policies that are directly related to the Expressway Management Plan.

The state highway classification system divides state highways into five categories based on function: Interstate (NHS), Statewide (NHS), Regional, District, and Local Interest Roads. Under OHP Policy 1B.7, the highway segment is designated with community development characteristics. This includes Special Transportation Areas (STA), Commercial Centers, Urban Business Areas, and Urban designations. The designations are defined with characteristics for design outcomes for each segment of highway with modal priorities identified. See Part 200 for more discussion on highway classification and function. Refer to Appendix A, for the Oregon State Highway functional classification and Appendix B, for the Oregon Highway Plan classification designation on a state highway.

Special Transportation Areas (STA) - The objective is to provide local auto, pedestrian, bicycle and transit movements to the business district or community center and these modes are generally as important as the through movement of traffic. People who arrive by car or transit find it convenient to walk from place to place within the area. Provide sidewalks with ample width which are located adjacent to the highway and the buildings. STAs are not located on freeways or Expressways.

Commercial Centers (CC) - The objective is to accommodate pedestrian and bicycle access and circulation and, where appropriate, transit movements. Provide convenient circulation within the center, including pedestrian and bicycle access and circulation. Provisions for transit access in urban areas planned for fixed-route transit service are to be included.

Urban Business Areas - The objective is to balance vehicular accessibility with pedestrian, bicycle, and transit accessibility. Safe and regular street connections are encouraged. Transit pullout, sidewalks, and bicycle lanes are accommodated.

Urban - The objective of an urban segment designation is to efficiently move through traffic while also meeting the access needs of nearby properties. Although pedestrians are generally not accommodated on Expressways for safety reasons, analyze accommodation on a case-by-case basis. Curbside sidewalks should be avoided on expressways.

Several conditions within the Urban Contexts require greater sidewalk widths in the Pedestrian Realm:

1. **When signs, mailboxes, or other appurtenances in the sidewalk become numerous, provide a sidewalk of at least 8 feet.** The width of a curbside sidewalk should be 8 feet in locations where the target speed is 45 mph or greater.
2. **Provide a total sidewalk width in Central Business Districts (CBDs), STAs and traditional downtowns at least 10 feet wide where buildings are located at the back of the sidewalk.** The preferred sidewalk width in high use business areas is 14-16 feet.
3. **Curbside walkways on bridges shall be at least 7 feet wide, to account for pedestrian shy distance from the outside bridge rail.** Newly constructed or reconstructed bridge walkway widths should not be less than the approaching walkway width on the bridge end. Pedestrian Zone widths must be equal approaching the bridge, crossing the bridge, and leaving the bridge.
4. **Where a walkway is separated from traffic with a barrier at the curb line, the walkway shall be at least 7 feet wide to account for pedestrian shy distance.**

Design exceptions are required for the sidewalks that are less than the values shown in Table 800-3. See Section 810.3 for Buffer Zone distances requiring a design exception.

Table 800-3: 4R/New Construction Pedestrian Realm Width Minimums (B = Buffer Zone, P=Pedestrian Zone, F= Frontage Zone)

Oregon Highway Plan Designation ⁹	Minimum Pedestrian Realm Width (B+P+F)	Buffer Zone or Frontage Zone Treatment
Special Transportation Area (STA), Central Business District (CBD) or Traditional Downtown	10 feet	1 foot paved Frontage Zone
Special Transportation Area (STA), Central Business District (CBD) or Traditional Downtown	12 feet	4 feet softscaped buffer strip
Urban Business Area (UBA), commercial centers and other developed areas	6 feet	Curbside, 1 foot paved Frontage Zone
Urban Business Area (UBA), commercial centers and other developed areas	10 feet	4 feet softscaped buffer strip
Urban Fringe: 35-45 mph Target Speed	8 feet	Curbside, 1 foot paved Frontage Zone
Urban Fringe: 35-55 mph Target Speed	10 feet	4 feet softscaped buffer strip
Expressway: 45 mph Target Speed	8 feet	Curbside, 1 foot paved Frontage Zone ¹⁰
Expressway: 45 mph Target Speed	14 feet	8 feet softscaped buffer strip
Expressway: 50-55 mph Target Speed	14 feet	8 feet softscaped buffer strip
Bridge Sidewalk and Sidewalk separated by Traffic Barrier	7 feet	Not applicable
Roundabouts	14 feet	3-foot detectable Buffer Zone

810.7.1 Walkway without Curb or Behind Ditch

Most sidewalks are separated from the roadway with curbs, which channelize drainage and provide positive separation from traffic. Curb and gutter can substantially increase the construction cost of a project. Where sidewalks are needed, but the high cost of curb and storm sewer cannot be justified, or where curbs don't fit the character of the street, sidewalks may be

⁹ Appendix B,“ OHP Appendix D: Highway Classification by Milepoint.”

¹⁰ Curbside walkways should be avoided on Expressways or when Target Speeds exceed 45mph.

constructed without curb for drainage. See discussion about Curb Zones in Section 810.2 for additional information.

Walkways may be located at roughly the same elevation of the traveled way. Walkways may also reside above or below the traveled way grade depending on the local terrain. The Buffer Zone is designed to accommodate storm water conveyance and infiltration. The ditch or earth slope (cut or fill section) are both barriers to access the walkway for all people. When a walkway begins or ends, slope entrances and exits to the walkway are required to be accessible. At grade pedestrian connections are made when the Pedestrian Realm doesn't have a Curb Zone, and these connections are referred to as "at grade" pedestrian connections or pedestrian ramps. See additional requirements in the curb ramp design Section 815.

On roads with a rural character, where drainage is provided with an open ditch, and where there is sufficient room, walkways may be placed behind the ditch. **Pave driveways 15 feet back from the back of the Pedestrian Zone to avoid debris accumulation and maintain an accessible pedestrian path of travel.**

810.7.2 Walkways on Bridges

Provide walkways on both sides of bridges where pedestrian use can be expected. When designing walkways for bridges, the design life of a structure is 75 years or more. The walkway width will be in place for generations to come and is difficult to adjust later due to the impacts on the substructure design. Walkways on bridges are often a destination for pedestrian viewing of waterway features including boating, wildlife, and recreational fishing. Wider walkways allow for both the transportation need and occasional or planned recreational usage. See discussion on Shared Use Path design in Section 845.

Provide a Pedestrian Zone at least 7 feet wide on bridges when the walkway is for transportation use only to account for shy distances. See Section 900 for shared use path design width requirements. The Pedestrian Zone is exclusive of any curb, railing or concrete barrier on the bridge. **A 1-foot pedestrian shy distance is needed from each concrete barrier and/or pedestrian railings constructed on bridge walkways.** This shy distance is both from moving traffic and from the outside bridge rail, as some people feel uncomfortable walking close to a high vertical drop. Consider wider sidewalks in urban settings with high pedestrian use based on the Urban Context. **The bridge sidewalk must not be narrower than the approaching sidewalk at the bridge ends.** Walkways on bridges with design speeds greater than 40 MPH require a vehicle traffic barrier at the Curb Zone.

Figure 800-17: Minimum Bridge Sidewalk Width

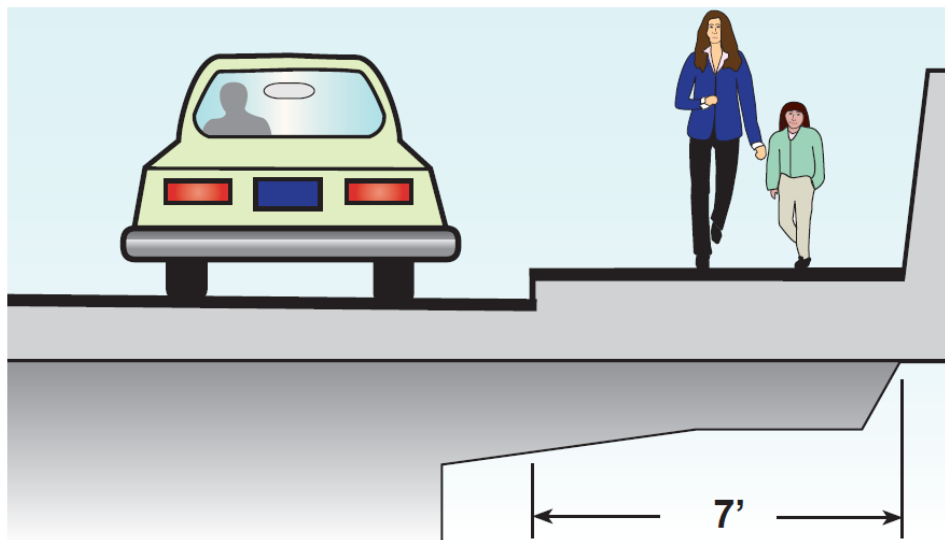

Walkways on bridges also have additional pedestrian access route concerns that need to be reviewed in coordination with the bridge designer. Clear widths for pedestrian access routes are measured from the nearest vertical surface exceeding $\frac{1}{4}$ inch in height or any object/feature that protrudes into the Pedestrian Zone and excludes the Curb Zone. Monolithic construction of the Curb Zone and walkway occurs frequently on bridges for various structural reasons. There is an implied curb and curb zone width (6 inches) which does not count towards the clear width requirement. Grout railing pads, decorative lighting, guardrail posts, and bridge rail connections often reduce the effective width of the Pedestrian Zone and pedestrian access route. (See discussion on Pedestrian Railing in Section 810.9.) Walkways on bridges include bridge expansion joints that are required to meet the pedestrian access route surface requirements and should be flush (See discussion in 810.5 on pedestrian access routes).

810.7.3 Walkways with Curb

Walkways should not be placed directly adjacent to a high-speed travel lane (45 MPH and above); they should be buffered with a planting strip, a parking lane, or a bike lane via the Buffer Zone or Transition Realm. Curbside walkways should be avoided on expressways. Where walkways are curbside in constrained areas, a 1 foot paved Frontage Zone is required. In the absence of any separation via Buffer Zone, curbside walkways next to high-speed roadways should be at least 8 feet wide, as the two feet adjacent to the curbing are used for poles, sign posts, etc. See discussion on Buffer Zone and Transition Realm requirements. This results in an effective 6 feet wide Pedestrian Zone and provides 2 feet shy distance from high-speed motor vehicle traffic. Greater sidewalk widths are needed in high pedestrian use areas, such as Central Business Districts, where 10 feet is considered necessary, as the Pedestrian

Realm is often also used for street furniture and other pedestrian amenities. Pedestrian Realms with widths 12 feet to 16 feet or greater are common in Central Business Districts.

Restaurant seating and other private business use on state right of way is not consistent with the use of the Highway Trust Funds and is generally not permitted on state owned sidewalks. *Review the Delivery and Operations Division Notice MG14-04 for current state policy.* Many sidewalks along the highway are under local road authority and may require additional coordination or permits if the sidewalk is closed for private business use temporarily.

Figure 800-18: Recommended Curb Side Sidewalk Dimensions

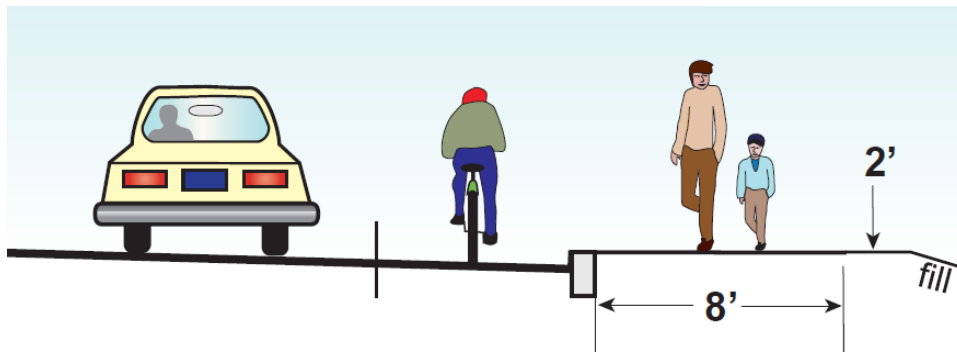
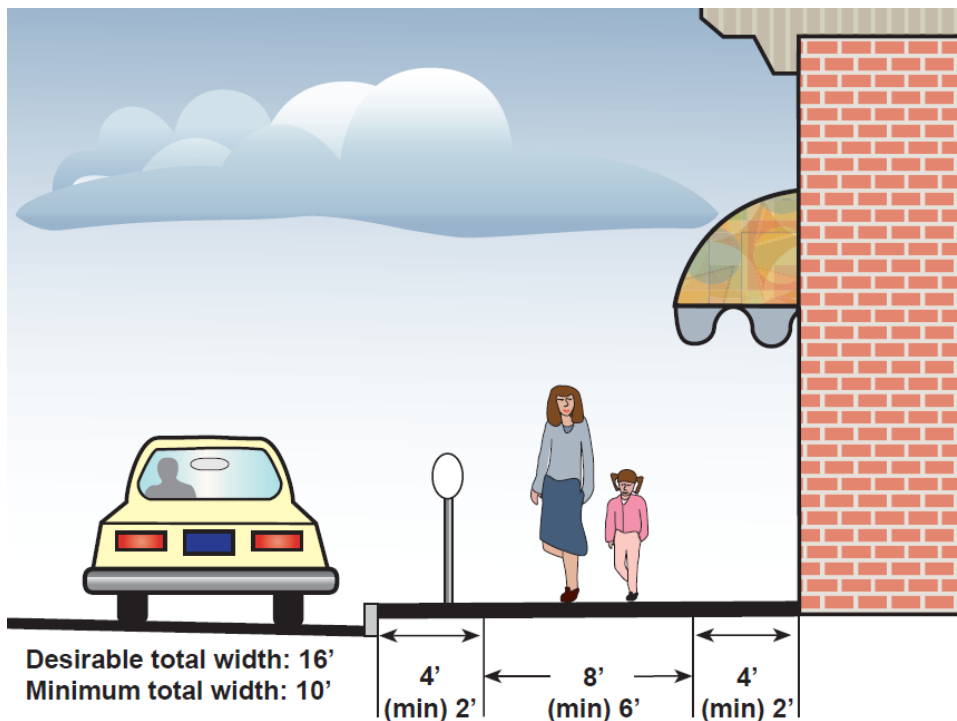

Figure 800-19: Recommended Central Business District Sidewalk Dimensions



810.7.4 Pedestrian Lanes

Pedestrian Lanes are a type of walkway that is at the same grade and is contiguous with the Travelway Realm. It often resembles a travel way shoulder, but it is reserved for pedestrian use. It is denoted for use by pedestrians only by the addition of pedestrian only pavement markings/icons, pedestrian only signing, a raised curb (typically a drainage curb as shown in the RD700 series), or concrete barrier that separates the pedestrian travel mode from vehicular use. Pedestrian lanes use markings and buffer striping to increase the distance between motorists and non-motorized users in some locations with low traffic volumes and speeds. When pedestrian lanes are provided, they must meet ADA pedestrian access route requirements including cross slope and running slopes.

Figure 800-20: Example Pedestrian Lane



Pedestrian lanes are not the preferred walkway configuration. Pedestrians are permitted to use the shoulder under the ORS. Challenges with pedestrian lane design include:

- detectability by people with vision impairments
- undesired use by bicyclists
- ADA cross slope requirements
- maintenance strategies including sweeping and snow removal

Pedestrian lanes are an interim facility, and a full walkway improvement should be planned for future implementation. They are not intended to be an alternative to permanent sidewalk, but often fill short gaps between higher quality pedestrian facilities. *Regional approval is required on the Urban Design Concurrence Document in the Urban Contexts for pedestrian lanes.*

810.8 Walkway Surfaces

Walkways must provide a surface for the intended pedestrian use considering the long-term costs, construction accuracy and maintenance requirements. **Sidewalks, pedestrian lanes, and shared use paths must be firm, stable and slip resistant to meet ADA requirements throughout all weather conditions year-round.** Firm means that the surface must resist deformation or indentation. Slip resistance is not defined by a coefficient friction value, rather agencies must determine what is best practice based on engineering principles and construction practices for slip resistance. Slip resistance is historically provided with a broomed surface finish on Portland cement concrete on walkways. **Trails must provide a stable and slip resistant walking surface to meet ADA requirements.**

Concrete is the preferred material for walkways on site improvements, sidewalks, shared use paths and the pedestrian access route. It provides a smooth, durable finish that is easier to grade, repair and meet ADA surface requirements. Concrete surfaces are finished to smooth and uniform texture by troweling, floating and cross brooming to provide slip resistance. Industry construction for concrete is more precise making it easier to achieve ADA slope requirements during finishing. Concrete's service life can easily span several decades requiring little to no maintenance of the surface.

Asphalt pavement is not the preferred material for sidewalks and shared use paths as slopes are more difficult to control and the life span of the material is shorter. Asphalt walkways are more susceptible to cracking and irregularities due to freeze thaw conditions, tree root growth, and poor compaction of the foundation material. Asphalt is typically a lower cost alternative that can meet the ADA surface requirements however compaction tools create greater variability in the finished slopes. Asphalt pavement surfaces are a more accessible surface for recreational outdoor trails and reduce maintenance needs compared to an unimproved trail.

Bricks and ornamental landscape pavers should not be used as the primary walking surface or in the pedestrian access route. They may be used for aesthetics or providing contrast in the buffer and frontage zones. Walkway embellishments can also be achieved by treating concrete with colored dyes or with decorative scoring. Bricks and pavers installed with a great degree of smoothness can meet the ADA surface requirements when constructed flush with no horizontal gaps and with no beveled edges. Do not utilize bricks or landscape pavers that are beveled or "pillowed". Bricks and pavers will need to have a slip-resistant surface when installed; they are often manufactured with smooth finishes and when wet will become slippery. Long-term maintenance costs should be recognized when selecting bricks or pavers as the walkway

surface. Bricks and pavers overtime are more likely to become displaced because of freeze and thaw conditions, or tree roots which create vertical discontinuities (lips) in the pedestrian access route and pedestrian circulation areas.

Bricks and pavers are a type of hardscaping that is considered walkable that maybe utilized in the buffer zone for aesthetics. **Bricks and paver should not be installed in the vicinity of curb ramps in lieu of flared sides without additional treatments.** See additional discussion in Section 815 for curb ramp design requirements. Low vision and blind travelers cannot distinguish the difference between bricks and Portland cement concrete underfoot and confuse these type of surfacing materials as something that is intended to be walked on in many situations in other environments. Bricks and pavers can be aggravating and painful for some people with spinal cord injuries and other conditions as vibrations occur when mobility device users traverse the surface joints. ASTM-E3028 is a standard for determining wheelchair pathway roughness index related to comfort, passibility, and whole-body vibrations.

An alternative to pavers is stamped and dyed concrete. This alternative provides much of the aesthetic value of bricks with the durability and smooth surface of concrete. Decorative treatments in the street or crosswalk which consist of concrete color or scored patterns are not a marked crossing. See the Traffic Manual for pavement markings at crosswalks. Colored concrete provides contrast which may assist with wayfinding for people with vision impairments when used on the edges of the pedestrian zone or pedestrian access route. **Do not use stamped concrete patterns that create rough surfaces in the pedestrian access route or pedestrian circulation areas. Treatments such as grouted durable rock require approval for installation. Use of stamped concrete pattern area in the vicinity of curb ramps will require concurrence from the Senior ADA Standards Engineer.**

810.8.1 Pervious Walkway Surfaces

The concern over adding more impervious surfaces has led to the creation of a variety of permeable surface materials: pervious concrete and asphalt, pavers, and other innovative designs. The pedestrian zone is usually separated from the roadway with a bio-swale in the buffer zone when a pervious walkway surface is installed. Walkways built out of conventional impervious materials (concrete) contribute little to runoff if they are separated from the roadway with a vegetated buffer zone as most of the precipitation that lands on the sidewalk can be absorbed by the native soil in the buffer zone. Concrete mix design is critical in pervious walkways to avoid a rough surface.

Pervious walkway surface technology is evolving, and long-term maintenance is a concern. The concrete mix design is of particular importance, to avoid large voids in the final surfacing. If used, pervious walkway surfaces must still meet accessibility standards: firm, stable, slip-resistant, without vertical discontinuities or horizontal openings. While meeting the minimum ADA criteria, pedestrians with spinal injuries can still experience vibration when rolling over

pervious walkway surfaces. Pervious surfaces consisting of geo-grids filled in with aggregates or vegetation do not meet the accessibility requirements for the pedestrian access routes. Geo-grids can be considered for the other areas of the Pedestrian Realm or Buffer Zone; it is generally considered a hardscaping treatment unless vegetated growth is incorporated in the geo-grid.

Figure 800-21: Pervious Sidewalk

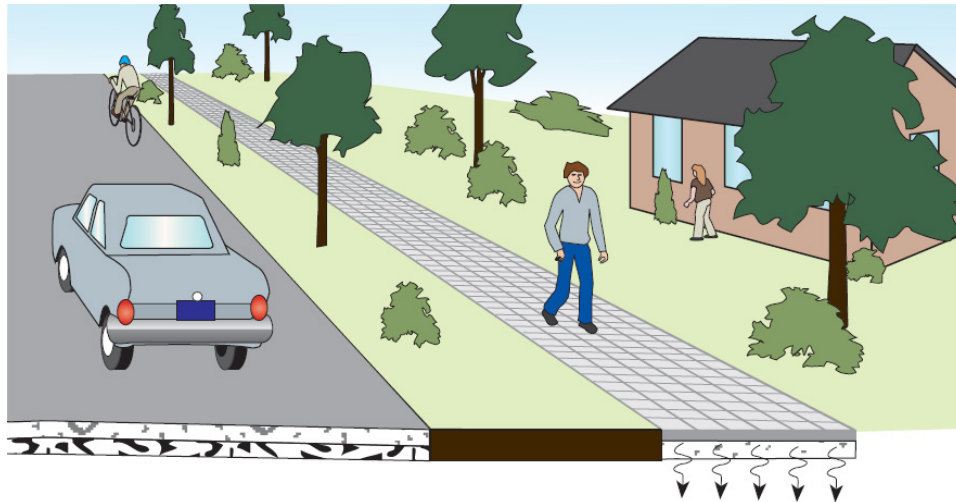

Consider the natural and local environment when a pervious sidewalk is constructed. Wet conditions can promote moss and mildew growth, and if not properly drained become slippery for all users therefore not meeting the ADA surface requirement for slip resistance. Pervious asphalt pavements in the walkway can trap water and freeze during winter events creating a slippery surface. Freeze thaw events degrade the life span of the asphalt pavement from surface cracking because of ice formations within the asphalt pavement. The walkway must be accessible all year.

Figure 800-22: Porous Pavement Installed Next to Concrete Walk Illustrating Mossy Growth



Figure 800-23: Porous Pavement Installed Next to Concrete Walk Illustrating Mossy Growth

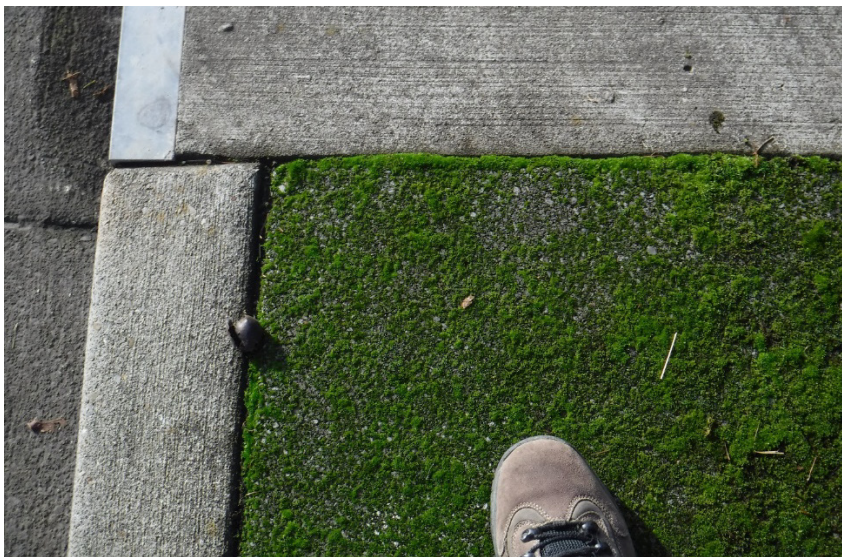

810.8.2 Surface Thickness

Walkways with foot traffic only are normally constructed with at least 4 inches of Portland cement concrete on top of a compacted base of crushed aggregate. When vehicular traffic is expected to occur over the walkway at driveways the thickness of Portland cement concrete is increased based on the design vehicle. *Typical driveway construction consists of 6 inches of Portland cement concrete, while heavily used industrial driveways need to have a pavement loading analysis performed to determine the surface material thickness.* Consult the Pavement

Design Unit for additional guidance on industrial driveway design. Refer to the Oregon Standard Drawings RD700 series for surface construction detail requirements on sidewalks.

Depth of asphalt construction of a walkway is shown in the RD600 series for shared use path pavement details. Shared use paths occasionally need to allow access for maintenance vehicles which will increase the asphalt pavement foundation and final surfacing depths.

810.9 Walkway Design

With new construction of pedestrian facilities where they did not previously exist, the desire is to create a sidewalk that is fully accessible when hard surfaces are constructed for the entire width. This ensures that over the life span of the walkway, pedestrian access route requirements are met and have the most flexibility to ensure ADA access when pedestrian amenities and features are temporarily or permanently improved, or disturbed. A key principle is that between arrival and destination points, there is a fully accessible pedestrian access route year-round. A Universal Design approach is best practice when designing walkways.

When a roadway has already been established in the built urban environment, roadway cross section reconfigurations may be altered to provide improved pedestrian experiences in the Pedestrian Realm. Particularly in the Traditional Downtown and Central Business Districts, the pedestrian access route and Pedestrian Zones are influenced by the existing elevation of building entrances. In this circumstance, walkways that have been disturbed or reconstructed are required to meet the pedestrian access route requirements with the improvement. A reduction in accessibility is prohibited with the alteration under the ADA. *The design should aim to provide a fully accessible walkway as best practice with any alteration of the walkway incorporating Universal Design.*

810.9.1 Horizontal Alignment

The Pedestrian Zone should be straight, or parallel to the adjacent road when the road naturally curves. Attempts to create meandering Pedestrian Zone usually fail because they do not serve the needs of pedestrians, who want to walk in the most direct route possible. The only exceptions should be when a sidewalk is substantially separated from a roadway, and the natural contours of the pedestrian zone are different from the alignment of the roadway, or to avoid large obstacles such as mature trees, or other pinch points. Care must be taken to assure the Pedestrian Zone is free of obstructions.

Figure 800-24: The Buffer Zone May Be Eliminated or Reduced at Pinch Points



Meandering Pedestrian Zones may be used to wrap around large obstacles, such as a mature tree or power pole. Though it adds some aesthetic value and offers possibilities to add creative landscaping touches, the results are often quite different. Most pedestrians prefer to walk directly, in a straight line. Meandering Pedestrian Zones can cause increased stress and make navigating difficult for the low vision and blind traveler as they are continually having to reassess their direction of orientation for walking. Meandering Pedestrian Zones are often scrutinized by the public when the sidewalk doesn't serve users well. Considerations for designing meandering walkways include:

1. Constructability due to the need for special forms.
2. Reasonable transition rates for pedestrians to deviate from their walking path. 1:10 is the preferred taper rate as pedestrian speeds vary. 1:10 taper rate accommodates the casual bicyclists, motorized wheelchairs, and pedestrians on foot running or walking. Use a 1:5 taper rate when constraints are in the available right of way. **Provide a 1:3 taper as a minimum rate change for widths and alignment changes.**
3. **Grade breaks are required to be perpendicular to the path of travel in the Pedestrian Zone when the constructed running slope exceeds 5.0 percent.** Design perpendicular grade breaks for slopes over 4.0 percent.
4. It is critical to maintain a straight pedestrian access route across driveways, curb ramps and road approaches (in crosswalks, marked or unmarked). The following techniques can be used to maintain cross slope requirements at driveways and prevent exaggerated warping and cross-slopes:
 - a) Reduce the number of accesses, thereby reducing the need for alterations at every driveway;

- b) Separate the Pedestrian Zone from the curb with a buffer; this allows the pedestrian access route to remain at the same slope of the roadway, with the driveway apron slope elevation change occurring in the Buffer Zone;
- c) Where constraints don't allow a Buffer Zone, meandering the Pedestrian Zone to the back of the driveway has a similar effect;

Figure 800-25: Meandering Sidewalk



Critical areas for the low vision and blind communities are street crossing points that may not be readily apparent. Complex intersections with many turn lanes, skewed angles and slip lanes with free-flowing traffic are particularly confusing to the blind traveler and low vision community. Right turn channelization islands are particularly challenging for people with vision disabilities. Techniques that can help reduce confusion and simplify the navigation task are below:

1. Keep the radius as tight as possible and place the crosswalks in areas where they are expected; in a straight line with the approaching sidewalks, pedestrian zone and curb ramps. See Part 200, Section 222 and Part 500, Section 506.9 for discussion of intersection radii.
2. Provide a clear and straight path through raised islands, pointed straight at the crosswalks.
3. Keep intersections tight and square to limit long crosswalk distances and skewed crosswalks;

4. Place crosswalks in areas where they are expected; in line with receiving curb ramps and approaching sidewalk in the Pedestrian Zone;
5. Keep crosswalks parallel with the adjacent Travelway;
6. Provide accessible and audible pedestrian signals;
7. **Install detectable warning surfaces at curb ramps to identify the transition from the sidewalk to the street.**

810.9.2 Vertical Alignment

Sidewalks are to be designed with the same profile slope of the roadway. A pedestrian with a disability might find that the roadway surface in the transition realm is the preferential path of travel when a sidewalk is visibly disjointed with multiple profile changes and is steeper than the roadway profile or has multiple sloped ramps when crossing driveways. Dipping the entire sidewalk or pedestrian access route along the Pedestrian Zone in a series to maintain the cross-slope on curbside sidewalks is not preferred or desirable as this creates a rollercoaster experience for the pedestrian.

Stairs are not permitted along the primary access route on sidewalks or walkways as this is a vertical change exceeding $\frac{1}{2}$ inch. **Vertical changes exceeding $\frac{1}{2}$ inch must be ramped with a sloped surface along the pedestrian access route.** Stairs can be utilized as an additional route for pedestrians when the primary access route is constructed and is fully accessible. Ramps are a required and critical design element to allow pedestrians to traverse to each point of service when there are vertical changes along the pedestrian access route. See discussion in Section 815 for curb ramps and Section 820 for building ramps design.

Elevation changes to elevate or depress a walkway must meet the ADA slope requirements. **When slopes are necessary to change elevation for driveways or to raise/lower the Pedestrian Zone, the slope surface is to be designed at 7.5 percent or less to allow for construction variances (finished constructed slope shall not exceed 8.3 percent).** See additional discussion on driveway design in Section 810.9. Grade breaks are required to be perpendicular to the path of travel in the Pedestrian Zone when there is a change in the profile (running slope).

Sidewalks whose running slopes are both steeper than 5 percent and do not match the grade of the adjacent roadway require an exception. Refer to Section 1005.4 for information about ADA exceptions. *When the walkway profile is steeper than 5 percent, consider adding level resting opportunities in the available right of way every 200 feet in the Pedestrian Realm (See RD 721).* This additional level resting area can also serve as the passing opportunity for pedestrians using a mobility device which is a flat and stable surface while waiting rather than utilizing a sloped surface which often requires hand braking. The Buffer Zone and Frontage Zone are areas of opportunity to provide additional pedestrian amenities including the level resting area and benches.

Connections to site arrival points such as a building entrance/exit on the sidewalk, are required to meet the pedestrian access route surface requirements. **Building ramp profile elevation changes are designed with less than or equal to 7.5 percent surface slopes (finished constructed slope shall not exceed 8.3 percent).** For building ramps, when a change in elevation exceed 30 inches (2.5 feet), a resting area (level landing) is required. For building ramps, a resting area (level landing) is required with any change in direction on the horizontal alignment. Changes in horizontal alignment are typically very prominent and are designed at angles in increments of 90 degrees to conserve space along the pedestrian access route for building ramps. Pedestrian handrails are required on building ramps in most circumstances, see additional discussion about pedestrian railings in the pedestrian rail section. See Section 820 on building ramps.

810.9.3 Cross Slope

Cross slope of a walkway is the grade of a surface perpendicular to the running slope or traversed surface in the direction of pedestrian travel. **The cross slope of a pedestrian access route may not exceed 2.0 percent at finished construction.** *Cross slopes are designed at a slope ranging from 0.5 percent to 1.5 percent to allow for normal finish surface variability during construction. Standard hydraulic practice typically requires 0.5 percent to properly convey storm water on a surface.*

When a roadway has already been established in the built urban environment, roadway cross section reconfigurations may be altered to provide improved pedestrian experiences in the Pedestrian Realm. Particularly in the Traditional Downtown and Central Business Districts which are very constrained, the pedestrian access route and pedestrian zones are influenced by the existing elevation of building entrances. *A level area should be provided at the building entrance to meet the pedestrian access route site requirements for ADA when working on an alteration.* Cross slopes in the Frontage Zone or Buffer (furniture) Zones may need to exceed the desired 1.5 percent design cross slope to meet the building entrance requirements.

Elevation changes in the cross section are easiest to handle in the buffer zone where signs and trees are most likely to be placed. *When choosing to alter the cross slope in the sidewalk review clear zone requirements and best practices in Part 400.* Cross slope changes in the Frontage Zone have added complexity due to the proximity to building foundations and basements. A common example where the cross slope of the sidewalk in the Pedestrian Realm has a steeper cross slope is in the driveway apron. Driveway apron slopes are designed for vehicular access to the property bridging the curb elevation change to the Pedestrian Zone, and the cross slope is greater than 1.5 percent. The driveway apron is useable for pedestrians to walk on if desired as part of the pedestrian circulation area, but it is outside the pedestrian access route and Pedestrian Zone. See Standard Drawings RD700 series for detailed driveway construction drawings.

Crosswalks reside in the traveled way, in the Travelway Realm and are extensions of the pedestrian access route. **Intersections controlled by stop signs or yield sign shall have a 2.0 percent maximum cross slope within the crosswalk.** The cross slope in crosswalks is permitted to equal the grade of the highway at midblock crosswalks. **When the crosswalk traffic operations is signaled or uncontrolled by a traffic control device, the maximum cross slope is 5.0 percent.**

810.9.4 Clear Width

The clear width of a walkway is the narrowest width found within the walkway that is fully accessible for pedestrians. Surfaces with cross slopes exceeding 2.0 percent, vertical obstructions or vertical discontinuities are not fully accessible and are not included in the pedestrian access route. The pedestrian accessible route and temporary pedestrian accessible routes are both defined terms in the Oregon Standard Specifications, which may vary slightly from the definition and use within the Highway Design Manual. Clear width is measured anywhere within the pedestrian circulation areas, along pedestrian accessible routes and the Pedestrian Zone. Clear width is also required for temporary pedestrian access routes and temporary curb ramps. The minimum clear width for acceptance varies based on the walkway configuration and Pedestrian Zone requirements.

Clear widths are reduced by objects that are less than 7 feet above the walking surface along the pedestrian accessible route. Objects such as pushbutton pedestals, signals, signs, utility poles, fire hydrants, etc. are frequently in the Buffer Zone and Frontage Zone. There may be a mailbox in the path or guywires above the sidewalk. These could be the controlling feature for the clear width measurement in addition to the cross slope. Guardrail is another common obstruction restricting the clear width of the pedestrian access route and Pedestrian Zone where the bridge connection to the bridge rail is installed. Review RD400s and RD500s for the width of the thrie beam and concrete barrier.

Refer to the RD100's and RD 700's for additional details on clear width when there are objects in the sidewalk. Mailboxes and the supports are placed in the Buffer Zone of the sidewalk and must meet United States Postal Services reach height and distance from the pavement surface. *The back sides of the mailbox receptacle is a protruding object in the walkway in many cases; best practice is to install in softscaped buffer strip to address this ADA requirement.*

810.9.5 Pedestrian Rail

Pedestrian rail is a safety device for pedestrians and bicyclists on walkways. Pedestrian rail may be required at locations other than bridges, including building ramps and at back-of-walk locations. Typical pedestrian rail consists of handrail and pedestrian fencing. Other features can also be installed which provide an equivalent function of pedestrian railing. Some types of

barriers including bridge rails and concrete barrier on a walkway can be integrated in the structure providing pedestrian protection and separation from another travel mode. Chain link fencing (see RD800's) may also serve the same function of pedestrian rail in some locations. Remove the top rail where fencing can be struck by errant vehicles in the clear zone.

Handrail is used for navigating elevation changes in the pedestrian access route on a building ramp. ADA requires that building ramps with a rise greater than 6 inches include handrail. Handrail details provided in RD770 & RD771 is sufficient for these conditions meeting accessibility requirements. Handrails are not required on pedestrian circulation paths; however, where installed they must comply with the ADA requirements. Handrails can be a mitigation tool in steep terrain on walkways or curb ramps. Handrail in RD770 has not been crash tested for vehicle departures from the travel way and should be consider a fixed object when installed.

Pedestrian rail must be at least 42 inches and used for areas with significant elevation drops. Details are provided in RD 780's for aluminum pedestrian fencing which has been crash tested under MASH criteria (see discussion in Section 401 on roadside clear zones.). The need for a pedestrian rail at the back of the sidewalk depends on the combination of several factors, however a singular condition might warrant pedestrian rail. Consider any OSHA requirements for areas that maintenance employees may need to occupy to perform work. Consider the combined effects of the following when determining the need for pedestrian rail, but it is not limited to these conditions. Mitigating for one factor may remove the need for a rail.

1. **Height:** A vertical drop of 2.5 feet or more would normally require a pedestrian rail.
2. **Steepness of slope:** A slope steeper than 1:2 (V:H) would normally require a pedestrian rail particularly for very tall embankments.
3. **Material of slope:** Riprap or other hard and sharp materials stabilizing slopes may trigger a need for pedestrian rail.
4. **Shy distance:** A shy distance of 2 feet or greater at the same plane as the walkway may be sufficient to mitigate the need for a pedestrian rail.
5. **Object at bottom of slope:** Moving traffic, deep or fast-running water would normally require a pedestrian rail.
6. **Users:** A preponderance of elderly, disabled, or very young pedestrians would benefit from a pedestrian rail if there is a higher likelihood they would lose their balance if they wandered off the sidewalk.

For example, a walkway on a 10-foot-high fill, with a 1:1 side slope made up of riprap, at the edge of a deep river, pedestrian railing should be installed. However at a location with 10-foot high fill, with a grassy side-slope, at the edge of a field, could be mitigated by ensuring there is at least a 2-foot additional width of material constructed behind the walkway to create a shy distance beyond the Pedestrian Zone (see Figure 800-26).

Figure 800-26: Pedestrian Rail at Back of Walkway

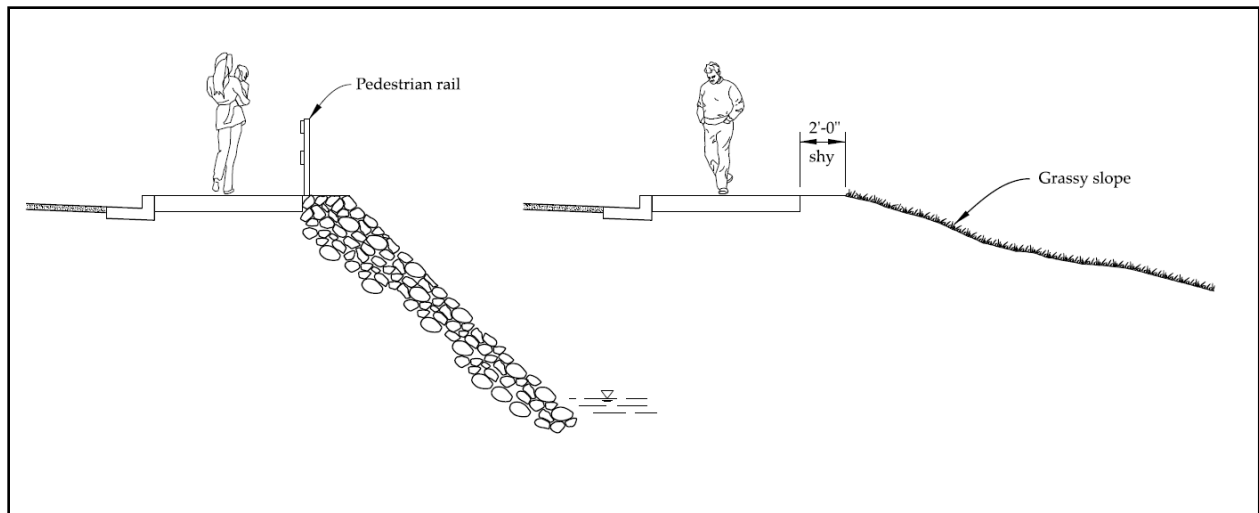
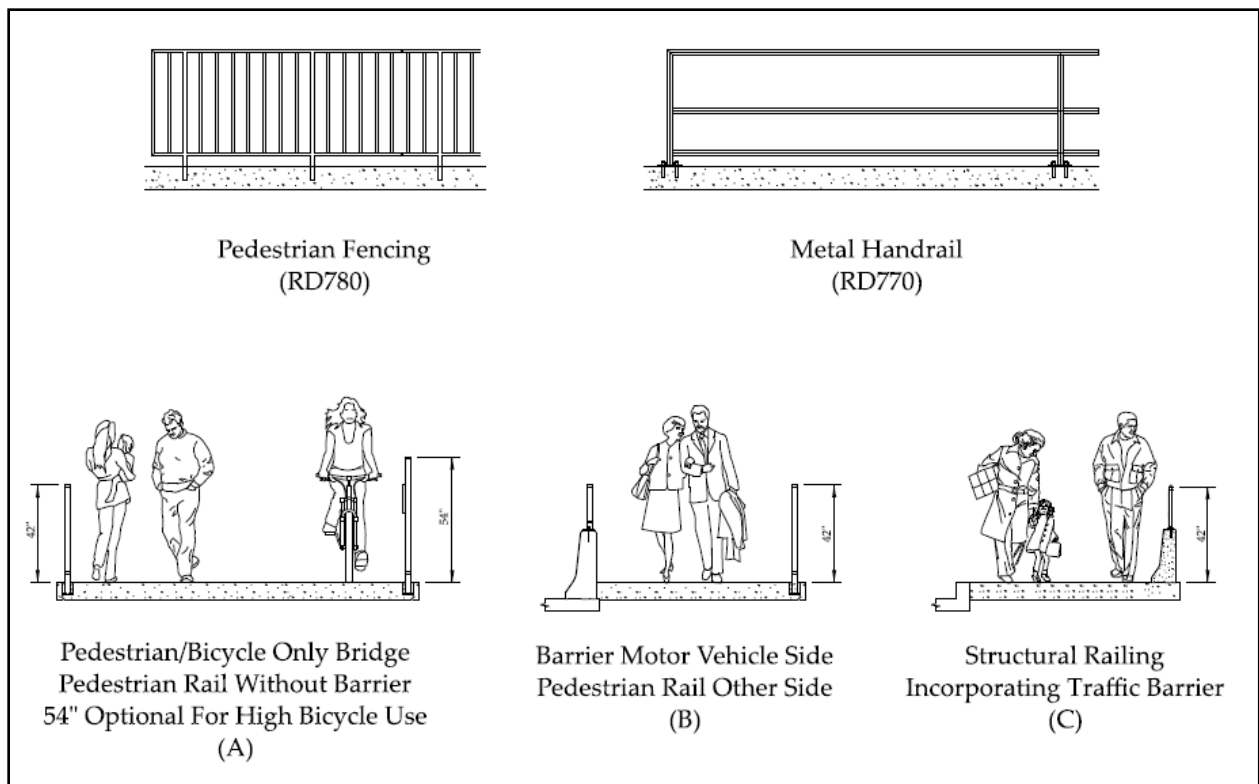

Figure 800-27: Pedestrian Rail at Bridges and Vertical Drops



Provide rail with a height between 48 and 54 inches when the walkway is a shared use path and high volumes of bicyclist traffic is expected. A 12-inch-wide concrete barrier is recommended from 30 inches to 42 inches. When a concrete barrier is installed, Case C, in Figure 800-27: Pedestrian Rail at Bridges and Vertical Drops, the Pedestrian Zone width is

measured from the outside edge of the barrier, as the space occupied by the barrier is not useable by pedestrians. Ensure the Pedestrian Zone and pedestrian access route clear width requirements are met. See discussion in the previous subsection.

810.9.6 Driveways

Driveways provide vehicular access across the Pedestrian Realm to private property. The geometrics of driveway are illustrated in the RD700s series. Driveway design is based on studies including National Cooperative Highway Research Program (NCHRP) Report 659. A pedestrian access route must be provided when the walkway crosses/overlaps the driveway. Refer to Section 505 for additional driveway design considerations and styles.

Design at least a 50-inch pedestrian access route across a driveway approach along the walkway. Finished construction must yield a 48 inch fully accessible pedestrian access route through a sidewalk driveway. The best practice is to plan sidewalks with Buffer Zones with a width that allows the Pedestrian Zone to be a straight continuous alignment along the sidewalk across the driveway and equal to the desired Pedestrian Zone width selected for the Urban Context. This allows the pedestrian access route to be at the same elevation as the general walk and easily achieve the ADA requirements minimizing the roller coaster effect along the sidewalk. See RD 700s for driveway styles Option A, Option B, Option D, and Option E for design requirements on ODOT facilities as these are the preferred driveway configurations for the overall pedestrian experience and accessibility.

Consider reconfiguration of any radial style driveways that do not conform to the recommended dustpan style as outlined in Part 505, Table 500-1 in coordination with the access management strategy for the project. This improves the pedestrian access route, clarifies expectations of pedestrian priority over vehicular right of way, and removes curb ramps that may not be necessary from the ODOT ADA Ramp inventory. Fully lowered parallel driveways, Option G, are not the preferred choice for pedestrian accessibility as there are often insufficient cues for many low vision or blind travelers to detect the boundaries of the sidewalk from the Travelway Realm. Mobility device users and pedestrians experience a roller coaster effect when traversing a series of fully lowered driveways due to the multiple vertical alignment changes. **Notify the Roadway Statewide Asset Specialist when a curb ramp is removed from the ODOT ADA Ramp inventory due to driveway reconfiguration.**

A pedestrian access route must be provided in street and driveway approach connections with improved surfacing (See RD715). The pedestrian crosses the roadbed in this situation along the street grade (See RD 715) and accommodates future sidewalk improvements. In many circumstances the existing approach is not built in compliance with accessibility standards. **Provide a fully accessible pedestrian access route when the street or driveway approach is reconstructed.** The pedestrian access route must reside on public right of way or a permanent

easement to ensure a private property owner does not affect the accessibility improvements in the future.

810.9.7 Hydraulics

Walkways should be free from debris and divert storm water captured from the impervious area to the storm water treatment facility. **ADA requires that pedestrian walkways prevent accumulation of water.** This means they should be free from debris and standing water. Typically, walkways are sloped toward the Curb Zone and travel way where storm sewers collect both the storm water from the travel way and walkway. Cross slope is designed at 1.5 percent in most circumstances. When the profile grade (running slope) of the walkway is steeper than the cross slope, the flow path of water changes directions and in some cases no cross slope is required at all. The storm water will runoff to the travel way adequately. *Best practice is to divert the storm water off the walkway as soon as practical with a cross slope of 1.0 percent to 1.5 percent depending on the surface material.*

Walkways may also have a reversed cross slope away from the Curb Zone in some configurations. Consider reversed cross slope walkway design on roundabouts where storm water can be collected in an open ditch rather than a closed storm sewer system. This reduces the size of the storm sewer system lines under the roadbed. Urban roundabouts should consider utilizing a steeper cross slope in the buffer zone to facilitate drainage conveyance particularly when constructed with a hard impervious surface. Refer to Section 509 for additional roundabout design considerations.

Inlets are not placed in the pedestrian access route in any new construction of a walkway.

When an inlet must remain in the pedestrian access route on an existing walkway, the inlet grate shall not exceed the horizontal opening dimension of ½ inch which allows a ½ sphere to pass through in the direction of pedestrian travel. When the direction of pedestrian travel is not well defined, the ½ inch opening shall not be exceeded in any direction. Contact the Senior Standard Engineer and Senior ADA Standards Engineer when an accessible inlet grate is required for the project.

Inlets are generally installed upstream of a curb ramp for a crosswalk when there is a Curb Zone. Water conveyance must be addressed with another approved treatment if an inlet is not provided. **Addressing drainage and ponding is an ADA requirement.** Other measures to capture storm water can be provided when the walkway does not have a curb such as constructing a ditch channel in the buffer zone. Trench drains with an accessible grate can reduce ponding at the curb ramp opening in very flat locations to divert storm water; advantages of trench drains is that a subsurface trench can be designed with independent flow line slopes to connect to the trunk line. Refer to the Hydraulics Manual for determining the design storm, depth of water, and width of the spread at curb ramps and driveways. Ensure the design storm does not overtop the sidewalk or driveway onto private property per Oregon

Drainage Law. See Part 1200, Section 1211 Hydraulics and the Hydraulics Design Manual for additional information.

810.9.8 Pedestrian and Wayfinding Signs

Walkways generally require little signing. **When a crosswalk is closed, it must be signed per the ORS.** Most regulatory and warning signs are directed at motor vehicle traffic. See sections on street crossings and intersections and the Sign Design Manual for signs required in those situations.

Signs intended primarily for motorists may not serve pedestrians well. For example, directional signs are typically large, mounted high, and indicate destinations relatively far away for vehicles. On one-way streets, street name signs are often mounted only in the direction facing motor vehicle traffic, while pedestrians’ approach signing from all directions.

Consider adding lower-level signage facing both directions of traffic on larger and higher street signs used to inform driving vehicles. This helps pedestrians walking against the direction of traffic, so they can see the names of cross streets at the intersection. On two-way streets, signs mounted high on signal pole mast arms over the roadway should also be supplemented with conventional, smaller signs on the street corners.

Most walking trips are short, and the pedestrian's line of sight is different than a motor vehicle. Developing pedestrian scale wayfinding signs that lead to destinations within walking distance can improve the walkability of an area. Wayfinding signs can assist pedestrians new to the area, or residents who may not realize that the best route on foot is shorter or different than what they are used to driving. Examples of key destinations to include are libraries, schools, museums, recreation centers, shopping districts, city services, etc.

Figure 800-28: Sign Guidance for Wayfinding, ODOT Sign OBD1-3c

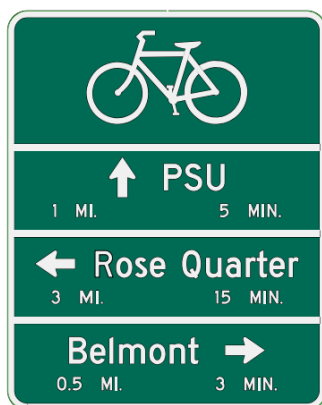

The objective of any wayfinding sign network is to efficiently guide users to their destinations, and to minimize back tracking. Signs should be unobtrusive, cohesive, visible, legible, intuitive,

and aesthetic. Signs for the use of bicyclists and pedestrians may use distance in miles and/or bicycle travel times.

810.10 Pedestrian Amenities

Many people use the public walkways for short destinations, exercise, and as alternative forms of transportation. For people with disabilities, the public walkway may be their only option that they can use independently. Pedestrians are exposed to the weather and use their own energy to move, and several low-cost improvements can be made to provide a better environment. In all cases these features must be located outside of the Pedestrian Zone, in either the Buffer Zone or the Frontage Zones. **Temporary objects must not block the pedestrian access route, either privately owned or publicly owned.** Items might include trash cans, advertising sandwich boards (A frame), feather flag signs, rental bikes, or parked vehicles.

810.10.1 Benches

People walking want to sit down and rest occasionally. In an urban setting, wide sidewalks, Buffer Zones and curb extensions provide opportunities for placing benches out of the walking zone. *Provide space for companion seating and accessible clear space for those with mobility devices. Provide a pedestrian access route to the front of the bench seating area.* Benches with back rests and arm rests provide a stable support for those with mobility issues to lower/raise themselves to/from the bench seat, or to bear weight on when standing and resting.

Figure 800-29: Bench in Buffer Zone



810.10.2 Awnings

Where buildings are close to the sidewalk, awnings protect pedestrians from the weather and can be a visual enhancement to a shopping district. **A vertical clear height of at least 80 inches must be provided for the Pedestrian Realm and in pedestrian circulation areas where awnings are installed.** Building code requirements may be more stringent. Contact the local agency and building department for additional requirements.

Figure 800-30: Awning Shades Sidewalk Cafe



810.10.3 Shelters

At bus stops, transfer stations and other locations where pedestrians must wait, a shelter makes the wait more comfortable. People are more likely to ride a bus if they don't have to wait in the rain and have a place to rest. Providing shade at transit stops improve the user experience during the wait for a transit connection. **Provide a pedestrian access route to the front of the bench seating area and a clear space for mobility devices to use the shelter. Companion seating, a clear space, and turning space for a mobility device is required when installing shelters with seating for the public. Trash cans and other advertisements permanently secured to the shelter need to be accessible and shall not infringe on the clear space, turning space and pedestrian access route.** See Section 805.4 and Part 700 for additional considerations for boarding and alighting areas for transit services.

Figure 800-31: Bus Shelter in Buffer Zone



810.10.4 Landscaping

Landscaping can greatly enhance the aesthetic experience for pedestrians, making the walk less stressful or tiring. Landscaping provides information to the vision impaired community where the intended walking route is. The contrast, textures, and sounds assist people with wayfinding along the walkway. The effective use of a planting strip can provide a buffer between travel lanes and sidewalks, as well as mask features such as sound walls. Choosing appropriate plants and ground preparation are important; seek guidance from ODOT's landscape architects. Refer to Section 406 for additional guidance on roadside tree placement. The following guidelines should be considered:

1. Plants should be adapted to the local climate and fit the context. Plantings should survive without protection or intensive irrigation, and should require minimal maintenance, to reduce long-term costs.
2. Plants must have growth patterns that do not obscure pedestrians from motor vehicles, especially at crossing locations, nor must they obscure signs.
3. Plants should not have roots that could buckle and break walkways (root barriers can prevent buckling); the soil should be loosened and treated with mulch deep enough so plants can spread their roots downward, rather than sideways into the walk area.
4. Plants should not have limbs that protrude into the Pedestrian Zone or pedestrian access route. **Vertical clearance under limbs must be maintained in the walkway to be fully accessible and prevent the vegetation from becoming a protruding object.**
5. Planting strips should be wide enough to accommodate plants grown to mature size.

810.10.5 Drinking Water Fountains & Public Restrooms

Drinking water fountains and public restrooms make it easier for pedestrians to be outdoors for a long time and to walk long distances without worrying about where to find a business that will accommodate their needs. **Drinking water foundations need to meet the ADA requirements for installation, operating heights and parts. A pedestrian access route must be provided to navigate to the fountain with a 3 feet x 4 feet clear space to approach, activate, and use the water fountain.** The clear space does not have to be level when located in the public right of way sidewalk adjacent a roadway. **The clear space must be free and clear of objects and free from any lips or vertical discontinuities.** A turning space may also be needed depending on the water fountain type and installation. *Best practice is to make the clear space level if feasible.*

810.10.6 Parklet and Outdoor Dining

Outdoor dining is being used more in urban areas for a variety of reasons. *See ODOT's maintenance and operation policy (MG 14-04) for the permitting process and considerations on state right of way.* Pedestrian access routes must be provided and maintained with outdoor dining whether it's seasonal or permanent.

810.10.7 Pedestrian Stairways

Stairways are not permitted in the Pedestrian Zone or along the primary pedestrian access route but may be provided as an alternative route to building entrances or other destinations. The requirements for the design of stairways is based on ADA requirements and the Oregon Building Codes. See RD100's for details. **Handrail shall meet the ADA gripping requirements and installation heights. Contrasting strips on the edge of the step provide information to pedestrians of the elevation change, particularly those with vision impairments or that have sight loss in one eye.** "When both eyes see clearly and the brain processes a single image effectively, it is called stereopsis. People who rely on vision primarily in one eye (called monocular vision) may struggle with depth perception."¹¹ The extension of the handrail provides a surface to bear weight when negotiating the first and last steps of the stairway per the ADA.

¹¹ Kierstan Boyd, "Depth Perception," American Academy of Ophthalmology, <https://www.aao.org/eye-health/anatomy/depth-perception>

Section 815 Curb Ramps

Curb ramps allow pedestrians with varying abilities to enter and exit the sidewalk or other similar pedestrian facilities and walkways. Curb ramps are built for use by pedestrians of all ages. They assist those experiencing permanent as well as temporary disabilities to access the sidewalk. Curb ramp systems are designed for pedestrians with diverse and varying abilities. A curb ramp is a system that typically provides a transition between the sidewalk and the street. It cuts through or is built up to the curb. Review the ODOT Curb Ramp Process in Section 802 and included in the Highway Design Manual, Appendix G, for additional discussion on how curb ramps are incorporated in the design development and construction contract process. Review the general intersection design principles in Section 506 when designing curb ramps.

There are multiple components that are constructed to build a curb ramp system. Curb ramp components include the curbing and gutter pan at the entrance/exit to the travel way, or other similar facilities in the Curb Zone. Components of the curb ramp system include areas that cross the Buffer Zone and tie into the Pedestrian Zone where pedestrians walk. Curb ramp design is based on the unique site constraints and features at each corner. No matter what the physical constraints are at a site, there are geometric requirements that curb ramps must meet.

The underlying design principles are the same for curb ramps and building ramps as they provide access to pedestrians with varying abilities. The ADA regulations however treat them differently resulting in some variations in design requirements. Under the ADA, private and public facilities must provide accessible routes to services from each site arrival and destination points. Points of service include but are not limited to parking lots, on street parking, transit stations, bus stops, building entrances, kiosks, signal push buttons, the sidewalk, and street crossings where accessible routes are required. These points of service may overlap jurisdictions and cross private property.

Both curb ramps and building ramps are a required and critical design element to allow pedestrians to traverse to each point of service when there are vertical changes along the pedestrian access route. **Vertical changes exceeding 1/2 inch must be ramped with a sloped surface along the pedestrian access route.** Stairs may be utilized as an additional route for pedestrians when the primary access route is constructed and is fully accessible. See Section 810 on walkway design.

Figure 800-32: Curb Ramp System with a Curb Ramp for Each Street Crossing



815.1 Curb Ramp Definitions

ADA Ramp - See Section 102.

Building ramps - A system of geometric components which serve both private and public buildings developments to allow pedestrians to access the business entry and exit points, and both interior and exterior spaces. Building ramps must connect to the Pedestrian Access Route externally and internally for pedestrian facilities such as exterior sidewalk on the business site or a hallway inside.

Curb ramp - A system of geometric components that are built up to or through a curb to access the walkway or street crossing in the public right of way or on building sites. It may also be referred to a sidewalk ramp or curb cut in portions of this manual.

Clear Width - The narrowest width found within the curb ramp system or walkway that is fully accessible for pedestrians.

Cross Slope - The grade of a surface perpendicular to the running slope or traversed surface in the direction of pedestrian travel.

Directional Curb Ramp - Curb ramp system where the ramp run(s) entering the Travelway Realm have centerline(s) parallel with the intended crosswalk.

Gutter Flow Slope - The grade at the gutter flow line at the bottom of a Ramp Run position 1. It is immediately parallel to the curb or street edge where water is conveyed to a drainage system.

Ramp Run - A sloped surface within a curb ramp system designed to bridge vertical elevation changes in the pedestrian access route.

Ramp Run Number - The number assigned to the ramp run for the curb ramps system. This is an ODOT specific convention.

Curb Running Slope - The surface slope on the top of the curb that connects to the ramp run, directional curb, gutter pan, or travel way roadway surface.

Pedestrian Ramp - An accessible sloped connection along the walkway. This occurs most often at grade with the roadway serving the crosswalk along the pedestrian access route.

Pedestrian Pad - A level area that is constructed to provide accessible access to a pedestrian feature such as a pedestrian signal push button at a rural signalized intersection, or other pedestrian features in the walkway.

Lip - A vertical discontinuity along the pedestrian access route, walkway, or pedestrian circulation areas less than 4.0 inches.

815.2 Curb Ramp Triggers and Scoping

Refer to the Engineering for Accessibility webpage for resources about curb ramp triggers in the current Directives, Bulletins, Advisories, Operational Notices and ODOT's ADA Curb Ramp Process (Appendix G). Triggering activities occur when an alteration occurs that effects the usability of a pedestrian crosswalk, sidewalk or walkway, and therefore presents the opportunity to construct an accessible curb ramp. When the concrete material (surfacing), or curb and gutter pan of the curb ramp system is disrupted, the curb ramp has been altered and requires reconstruction to the standard.

Right of way shall be planned for projects with curb ramp improvements per TSB18-03(D). The ADA requires upgrading curb ramps in alteration projects. The US DOT and US DOJ recently issued a memorandum of joint technical assistance to define when resurfacing projects are considered an alteration, which triggers the need to upgrade curb ramps. As a result, all 1R projects need to address curb ramps, except projects that only include chip seals. See Maintenance and Operational Notice MG 100-107-1 for direction on what is considered a maintenance pavement activity. See Maintenance and Operational Notice MG 144-03 for

direction on what is considered a signal maintenance activity for accessibility features on the pedestrian signal.

Locations of curb ramps that do not comply with the ODOT standard shall be upgraded when triggered by a project activity. Consult the ODOT ADA Transition Plan for other ADA project needs that should be incorporated into the project scope to meet the transition plan goals and schedule, utilizing state funds as efficiency as practical. Consult with the Active Transportation Liaison for CQCR requests that are to be addressed with the project scope.

815.3 Curb Ramp Configurations

Curb ramps and blended transitions must be wholly contained within the pedestrian street crossings or marked crosswalk served; see Criteria Q on the ADA Curb Ramp Design Checklist. Curb ramps shall not be blocked by legally parked cars as the curb ramp serves as the entrance and exit point for pedestrians to use both the crosswalk and sidewalk, or walkway (Criteria Q). Typically, two curb ramps must be provided at each street corner. **In alterations where existing physical constraints prevent two curb ramps from being installed at a street corner, a single diagonal curb ramp is permitted at the corner with a design exception; see Criteria A on the ADA Curb Ramp Design Checklist.**

One of the greatest factors when determining the safety of a pedestrian crossing is visibility. *Every effort should be made to remove or relocate objects that could obscure the view of and by pedestrians.* These include signs, traffic control boxes, tall vegetation, kiosks, etc. When possible, efforts should also be made to ensure that objects located on private property, such as neon and other illuminated signs, that could be a distraction to drivers are not located close to a crosswalk or curb ramp. Review Section 400 for clear zone and roadside tree evaluations at intersections.

Provide a curb ramp for each crosswalk on or along the state highway with vertical curbing in the Curb Zone. This includes Tee intersections on the public streets. This corresponds to the ADA Curb Ramp Design Checklist **Criteria A**. Typically a roadway intersection will have two curb ramps per corner that connects directly to the Pedestrian Zone of the sidewalk. *If one crosswalk is officially closed at a corner, it is recommended to design the remaining curb ramp in such a way that it guides users to the open crosswalk and provides physical and visual cues that discourage pedestrians from using the closed crosswalk. Review any design stipulations in the crosswalk approval letter from the STRE or road authority.* Curb ramps that align parallel with intended crosswalk are called “directional” curb ramps. A single diagonal style perpendicular curb ramp on an intersection corner direct users into the intersection and requires a turning maneuver in the roadway to utilize the crosswalk. **Ensure Criteria M is met, which provides a 4-foot x 4-foot clear space free from parallel vehicular travel when using the crosswalk. Stop bars when used are to fall within the range of 4 feet to 30 feet from the edge of traveled way and should be placed 2 to 3 feet from the back throat of the curb ramp opening on the side street (See the Traffic Line Manual).**

Providing curb ramps that have ramp run centerlines parallel to the intended street crossing is preferred (Directional Curb Ramp). A single diagonal curb ramp design is generally interpreted to serve both street crosswalks to low vision, blind, or deaf-blind travelers since they may not have cues or information to tell them otherwise. US national guidance for public right of way permits single diagonal curb ramps under alterations for street crossings; however, the use and application of single diagonal curb ramps is not uniform throughout the United States therefore it can mislead users. Where two curb ramps are not provided for the corner, a single curb ramp configuration that accommodates both crosswalks may be necessary to retain operations of both crosswalks for the pedestrian. A curb ramp that serves each street crosswalk provides a clearer and more uniform message to all individuals.

When a crosswalk is closed, it must be signed per the ORS. See the Traffic Manual for the crosswalk closure process and requirements and refer to Section 802.5 for more discussion. When a crosswalk is officially closed, the approval letter from the STRE serves as the decision document in lieu of the ADA Curb Ramp Design Exception, Criteria A and a design exception is not required for the corner. For local street systems, the approving authority for a crosswalk closure follows the local jurisdiction's process and documents. Curb ramp details are required to identify the crosswalk closure number in the contract. Review the details of the approval letter for other items specified which may need incorporation into the contract documents and may require coordination with other technical disciplines (typically traffic and sign designs).

Crosswalk closures should be limited during design and are not in intended to avoid construction of a curb ramp. Curb ramps are to provide access for all pedestrians to enter and exit the sidewalk and connect to the crosswalk. Pursue a crosswalk location determination following the procedures in the Traffic Manual if the presence of a legal crosswalk is in doubt (See Section 802.5).

815.3.1 Perpendicular Curb Ramps

“Perpendicular curb ramps have a running slope that cuts through or is built up to the curb at right angles or meets the gutter grade break at right angles where the curb is curved.”¹² Perpendicular curb ramps typically result in the largest footprint to make up the elevation difference for the curb height. The change in elevation is stretched over one ramp run perpendicular with vehicular travel way with a level area and turn space at the top of the ramp run. Perpendicular ramp runs are where cross slope warping occurs to meet a given gutter flow slope requirement. Single ramps on a diagonal alignment at the corner requires pedestrians to turn and reorient in the travel way. **Clear space must be made available for mobility devices at**

¹² PROWAG Preamble R304.2

the bottom of the single diagonal curb ramp and is required to be free from the vehicular travel ways. This corresponds to Criteria M on the ADA Curb Ramp Design Checklist.

Figure 800-33: Perpendicular Curb Ramp System

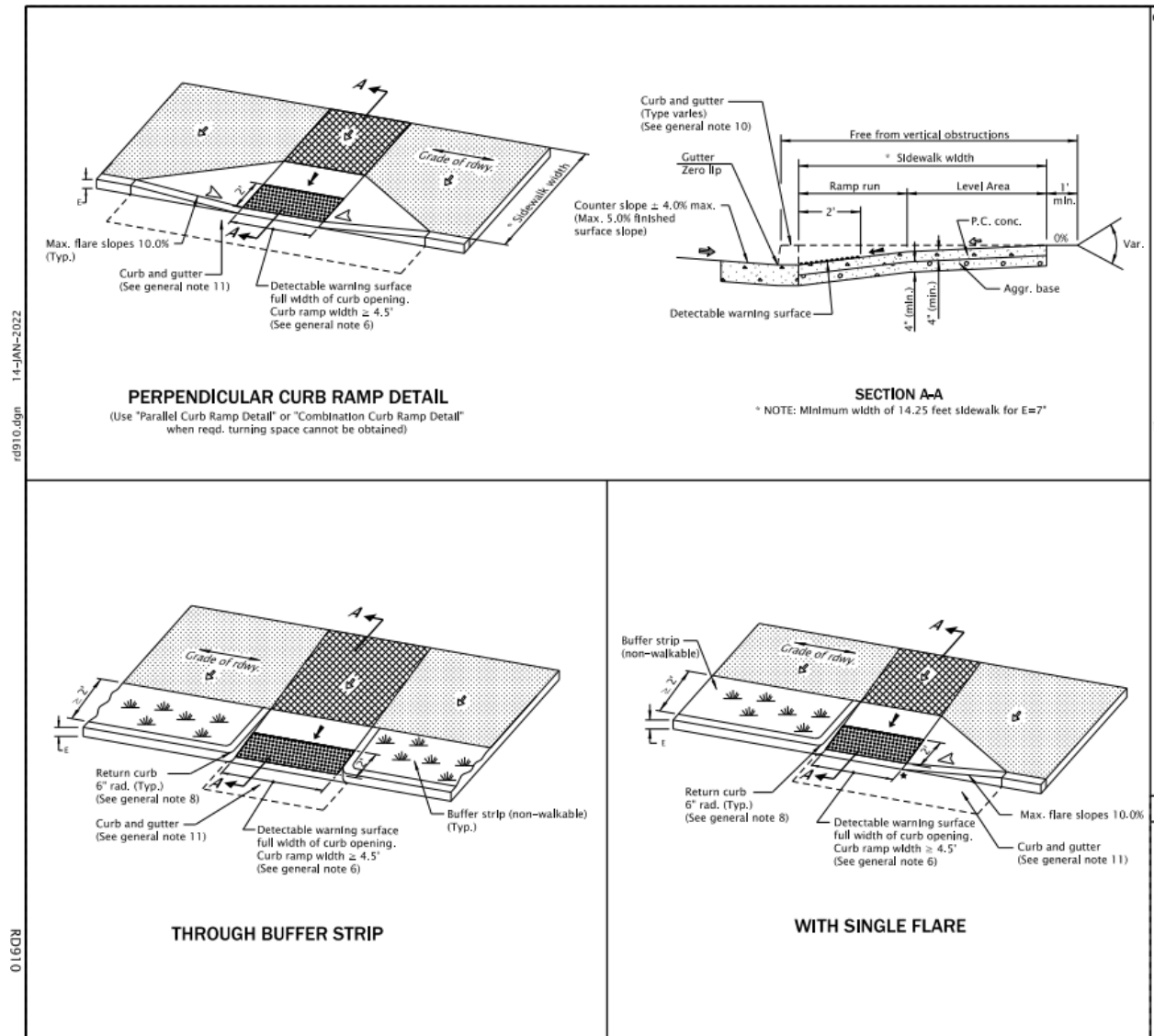

Review the [RD900 series](#) for additional layouts and construction requirements on perpendicular curb ramps systems. The Figure 800-33 above is an example of a perpendicular curb ramp.

815.3.2 Parallel Curb Ramps

“Parallel curb ramps have a running slope that is in-line with the direction of sidewalk travel and lower the sidewalk to a level turning space where a turn is made to enter the pedestrian

street crossing.”¹³ Parallel curb ramps should be reserved for constrained public right of way in curb ramp alterations where there are building foundation conflicts, large existing retaining walls, or bridge rail constraints. The elevation difference for the curb height is stretched over one ramp run parallel with the vehicular travel way with a level area and turn space at the bottom of the ramp runs. This style of curb ramp tends to separate the curb ramp opening for each crosswalk distance significantly at an intersection. This results in poor alignment with the receiving curb ramps and orientation cues for low vision and blind travelers.

Figure 800-34: Parallel Curb Ramp System

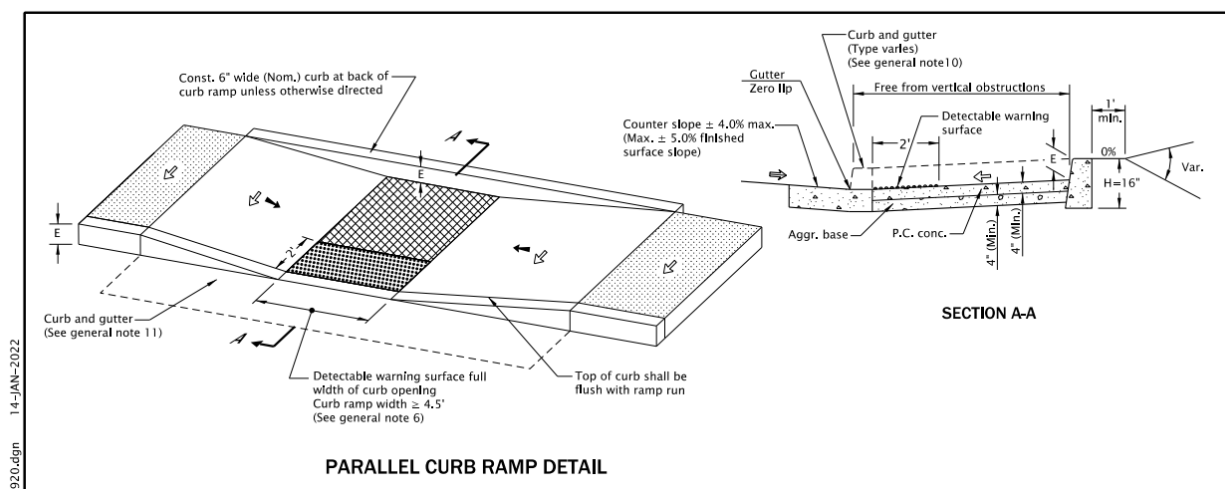

Review the RD900 series for additional layouts and construction requirements on parallel curb ramps systems. The Figure 800-34 above is an example of a parallel curb ramp.

815.3.3 Combination Curb Ramps

Combination curb ramps provide the most flexibility for design in meeting the ADA standards and reducing the footprint of the improvements. The elevation difference for the curb height is stretched over two separate ramp runs (one perpendicular and one parallel to the curb line) with a level area and turn space to change directions. This style of curb ramp can also facilitate larger or irregular shaped level areas to meet ADA requirements at signalized intersection with push buttons. This style of curb ramp is good for providing connections to the building entrances and adjoining walkways to private property/businesses. This style of curb ramp allows for directional curb ramps that align parallel with the intended crosswalk. Directional curb ramps are the preference for design.

¹³ PROWAG Preamble R304.3

Figure 800-35: Combination Curb Ramp System

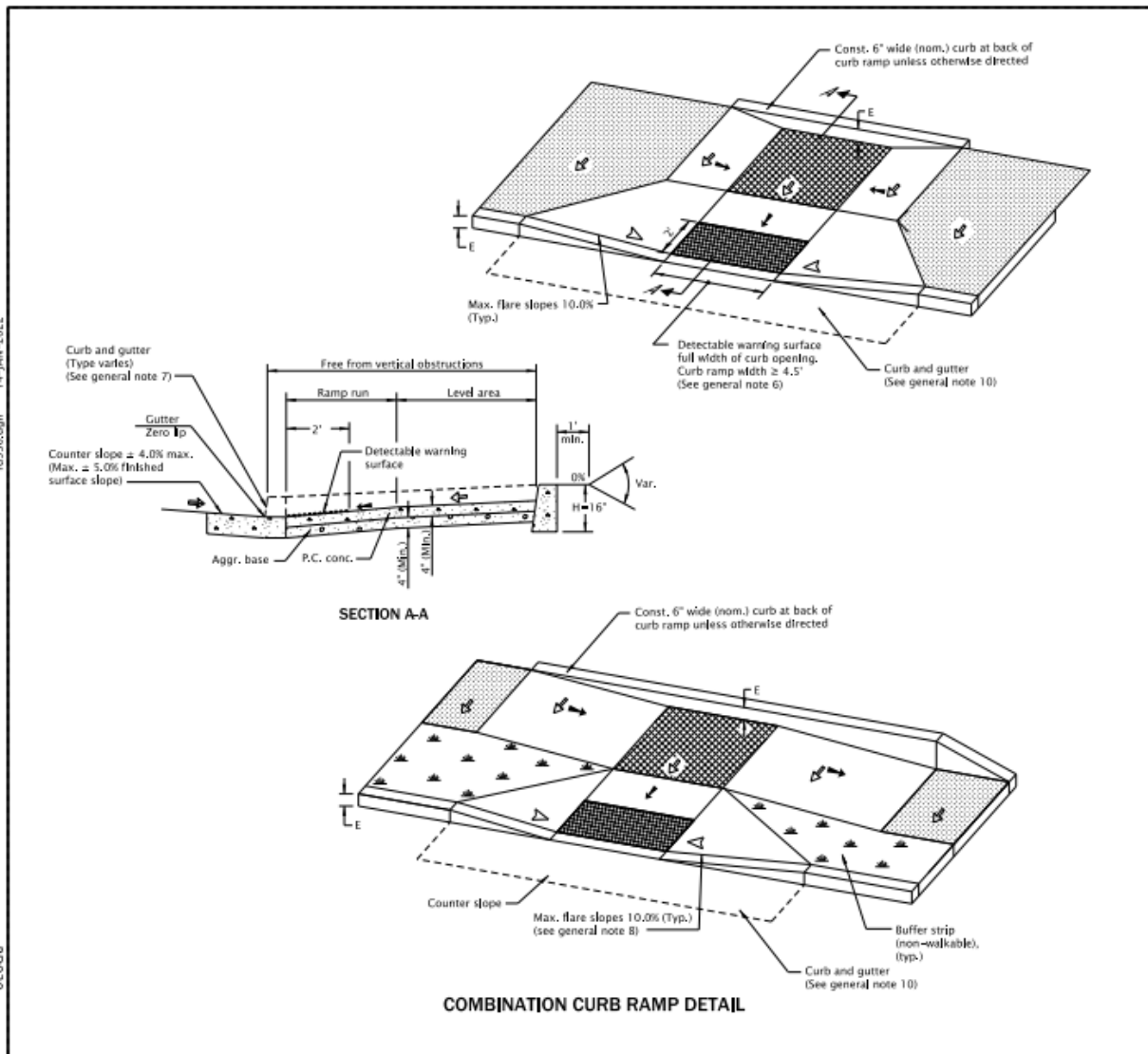

Review the RD900 series for additional layouts and construction requirements on combination curb ramps systems. The Figure 800-35 above is an example of a combination curb ramp.

815.3.4 Curb Ramps Next to Driveways

As discussed in the walkway design section (Section 810), curb ramps provide pedestrian access to the sidewalk or walkway. Providing positive separation between the vehicular access driveway throat and curb ramp opening is needed. Each site will need a design based on the existing site topography, property boundary, and access management considerations. Coordination with the Region Access Management Engineer is required when developing the

project's Access Management Strategy or modifying a driveway. Identify the system limits of both the curb ramp system and driveway system on the plan set details to reduce confusion during contract administration on unique designs. *Consider deeper concrete surface thickness for ease of construction and conforming to the driveway performance needs.* **Older designs where the curb ramp and driveway are one facility shared by the pedestrian and vehicle providing access from the Travelway Realm are no longer permitted.** In rare circumstances would that be considered a viable solution.

Details are shown for new driveway construction with horizontal separation distances for accessible routes which include 5 feet between successive ramp runs of the curb ramp system and the driveway system (see RD700s) when constructed. This is **Criteria P1** on the ADA Curb Ramp Design Checklist. Driveway design includes a certain amount of off tracking by a vehicle identified as the "p" distance on the standard drawings for driveway construction. Off tracking simulation software should be used to evaluate the design of a curb ramp driveway combination configuration based on the design vehicle. The available lane widths and shoulder widths vary with each corridor and impact the space for vehicles off tracking and approach speeds of drivers while turning. Creativity is key in designing a curb ramp driveway combination that meets all accessible route requirements and functions for the design vehicle. **Provide at least 5 feet of separation between the driveway throats and edge of the curb ramp throat (typically the turn space or level area) when constructed, Criteria P2.** This situation typically occurs when the pedestrian access route of the driveway is at the same level as the curb ramp pedestrian access route. Refer to the local jurisdiction driveway construction standard drawings, Options H thru Options N, when space is constrained between the driveway and curb ramp locations. The flared construction is much smaller and may be a design solution for meeting the separation requirement.

Designs that utilize a raised curb section to physically separate the curb ramp opening and driveway throat are evolving. *Provide constant curb exposure height (denoted "E") between 4 inches to 6 inches in height on the curbing.* Curbs for vehicles have vertical differences of 4 inches or more (See Part 300, Section 308 for curb types). This would replace what would otherwise be a flared wing or flared side to ensure white cane detectability, conspicuity, and depth perception of the area. Softscape materials included in the interior of the small, raised island provides the best performance of all desired attributes for pedestrians: detectability, conspicuity, contrast, visual appeal, and space for vegetation. **A minimum area of 3 feet by 3 feet from face of curb to face of curb may be considered when horizontally constrained in either direction (see Section 800 on Buffer Zone requirements, RD721).** To be effective, the size should be as large as practical. Smaller areas will require additional mitigation measures (i.e., white tubular markers) and will require approval as described in the Traffic Line Manual.

815.3.5 Pedestrian Ramps and Pedestrian Pads

Pedestrian Ramps are like curb ramps, except they do not cut through a curb along the pedestrian access route. They are accessible connections along the walkway, most often at grade with the roadway way serving the crosswalk in the pedestrian access route. Pedestrian Pads are level areas that are constructed to provide accessible access to a pedestrian feature such as a pedestrian push button at a rural signalized intersection. The same geometric requirements for curb ramps including but not limited to running slope, cross slope, counter slope, level areas, and installation of detectable warning surfaces are utilized for design of pedestrian ramps and pedestrian pads.

815.3.6 Unique Curb Ramps

Unique curb ramps styles are typically parallel style curb ramps that are missing ramp run components. This could include either Ramp Run position 2 or Ramp Run position 3, or both. A pedestrian pad is a unique curb ramp for inspection and inventory purposes as both Ramp Run 2 and Ramp Run 3 are missing.

815.3.7 Blended Transitions

Blended transitions are surfaces or connections with running slope surfaces under 5.0 percent located at the street entrance for the crosswalk connecting to the pedestrian access route of the walkway. Note, that pedestrian crossings in the traveled way should not exceed 5.0 percent in the direction of pedestrian travel. Crosswalk surfaces should not have running slopes exceeding 5.0 percent along the pedestrian access route beginning at the Curb Zone and entering the travel way. This does not preclude running slopes less than 5.0 percent on ramp runs 2 and ramp run 3. **A design value not to exceed 4.0 percent for both the curb running slope and directional curb surface is recommended in most circumstances to meet the requirements for accessibility (Criteria B3 and Criteria B4).** The top of the curb when designed less than 4.0 percent is a blended transition surface as shown in DET1752. See RD900's for blended transition curb ramps styles.

Truck aprons are designed with a blended transition running slope in the pedestrian access route and are not a part of the curb ramp system. The pedestrian crosswalk stops at the curb ramp system and when the pedestrian crosses the truck apron, they are in the street crosswalk. **Design the truck apron with a running slope not to exceed 4.0 percent in the pedestrian access route connecting to the curb ramp system for the sidewalk.** This is illustrated in RD170.

Shared Use Paths are often designed with blended transitions to cross the curbing as shared use paths should not have profiles exceeding 5.0 percent along the centerline. Raised crosswalks at

street crossings are a common form of blended transitions where the surface is flush with the concrete walk following the cross slope of the roadbed.

815.4 Geometric Controls for Curb Ramps

815.4.1 Curb Ramp Design Checklist

The ADA Curb Ramp Design Checklist (ODOT Form No. 734-5184) is a companion for curb ramp system design. This is an aid for designers in determining when design exceptions are needed on the design. This form is available on the Engineering for Accessibility webpage with the latest updates. Refer to the ADA Inspection Guide for Curb Ramps and Push Buttons as an additional resource. It will aid in your design of the curb ramp system.

When an ADA design exception is approved for a curb ramp system, a construction tolerance will be applied that is equal to the same margin for error that is used in the design of the curb ramp. See Table 800-4: Construction Allowance for Slopes below for the slope allowances on curb ramp systems with approved design exceptions.

Table 800-4: Construction Allowance for Slopes

From Roadway Tech Bulletin RD19-02B, 12/16/2020:

Curb Ramp Criteria		Approved Design Exception Value Exceeds	Construction Tolerance	Example Approved Design Exception Value	Example Allowed Inspection Value
Running Slope		7.5%	+0.8 %	7.7%	8.5% max
Curb Running Slope		7.5%	+0.8%	8.0%	8.8% max
Counter Slope		4.0%	+1.0%	4.8%	5.8% max
Cross Slope		1.5%	+0.5%	1.8%	2.3% max
Gutter Slope	Stop/Yield Controlled	1.5%	+0.5%	2.5%	3.0% max
Gutter Slope	Uncontrolled	4.5%	+0.5%	6.0%	6.5% max
Gutter Slope	Midblock	Roadway Profile Grade	+0.5%	5.5%	6.0% max
Flare Slope		10%	+0.8%	11.5%	12.3% max

Another fundamental concept in the enforcement of ADA by the US DOJ is that the standards have absolute minimums or maximum values, or sometimes ranges. Rules of rounding during inspection are applied differently than what is used in mathematical calculations. As an example, when the requirement is to provide a ramp run of at least 15.0 feet, a constructed measured length of 14.9 feet is not equivalent to 15.0 feet therefore failing the design

requirement. To ensure the minimum ADA standard is met, designers need to specify a value such as 15.5 feet that incorporates some margin of error during construction larger than 15.0 feet.

Table 800-5: Inspectors Rounding Guide for Curb Ramp Inspections

Rounding Guide:

Rounding to the nearest tenth	Round up	Round down
Ramp Runs	√	
Turn Space/Push Button Clear Space		√
Push Button Height (3.8 and up)	√	
Push Button Height (under 3.8)		√
Push Button Reach Range	No rounding, measure to hundredths	
FT Between Flares, Ramps, Driveways		√

815.4.2 Clear Width

Clear width is a critical component of any pedestrian access route. The clear width of a curb ramp is the narrowest width found within the curb ramp system that is fully accessible for pedestrians. **Constructed surfaces with cross slopes exceeding 2.0 percent, vertical obstructions or vertical discontinuities are not fully accessible and are not included in the pedestrian access route clear width. Curb ramp flares, curbs and obstructions are not a part of the clear width.** Clear width is measured anywhere within the curb ramp system and determines the width of the pedestrian accessible route. Clear width is also required for temporary pedestrian access routes and temporary curb ramps. The minimum clear width for acceptance varies based on the curb ramp system type and configuration. The design criteria for clear width of the pedestrian access route is listed on each curb ramp style in the standard drawings RD900 series.

Provide at least a 4.5 ft clear width through the pedestrian access route (flares and curbs are excluded from pedestrian access route) on the entering ramp run of a curb ramp system. This corresponds to the **Criteria F1** on the ADA Curb Ramp Design Checklist. When the back of the ramp is obstructed, additional space is required to complete the crossing at the level area and turn space. **The pedestrian access route and clear width connecting to the level area and turn space is required to be designed wider; at least 5.5 feet in the direction of the crosswalk with a vertical obstruction.** This corresponds to **Criteria J3** on the ADA Curb Ramp Design Checklist. *Best practice is to design the pedestrian access route equal to the Pedestrian Zone from the sidewalk, with matching clear widths at the turn space and along the ramp run entering the street crosswalk with a constant clear width. This will simplify the curb ramp design and provide a higher quality pedestrian facility.*

Curb ramps located at intersections corners are places where utilities and objects are often competing for space. Objects such as pushbutton pedestals, signals, signs, utility poles, fire hydrants, etc. are frequently in the curb ramp system. There may be a mailbox in the path or guywires above the walkway. These could be the controlling feature for the clear width measurement in addition to the cross slope. **Clear widths are reduced by objects that are less than 7 feet above the walking surface along the pedestrian accessible route.** The picture below illustrates an example of where to measure the clear width to find the smallest value to be recorded on the curb ramp inspection form.

Figure 800-36: Pedestrian Access Route Clear Width

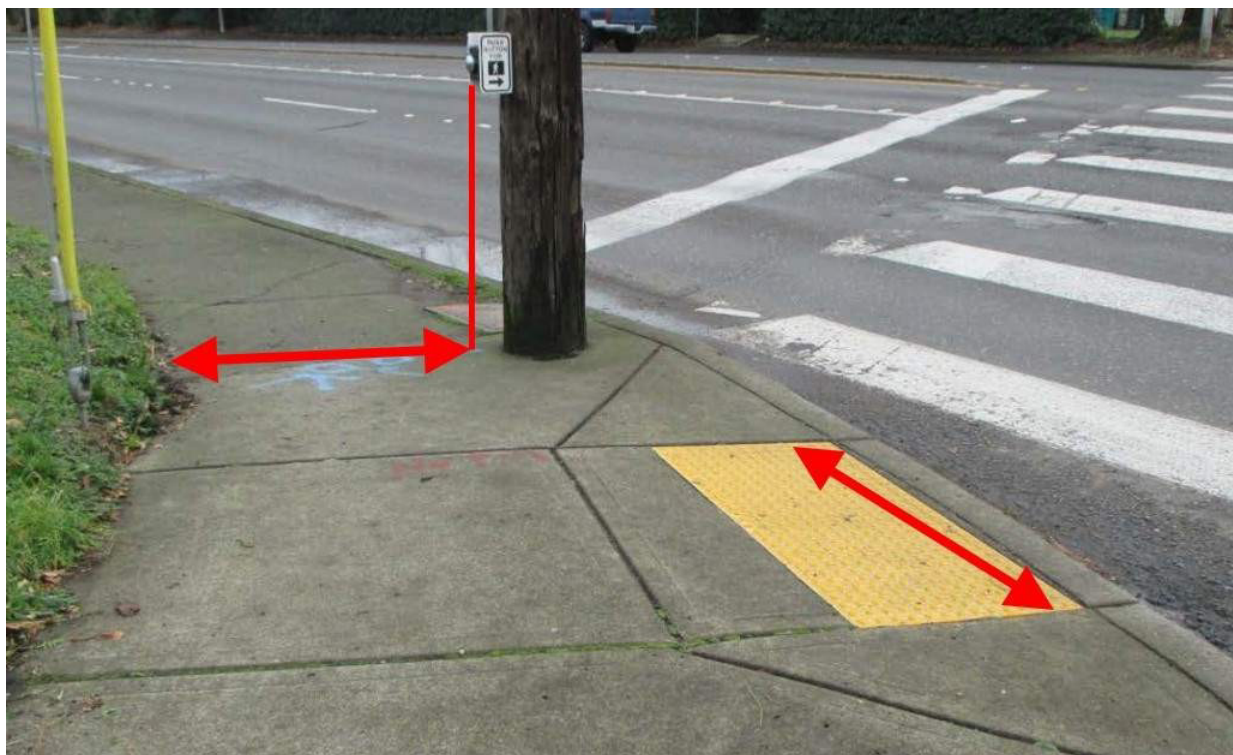

Provide a clear width through a cut-through island at least 5.5 feet. This ensures people in the crosswalk can pass each other when walking (e.g., walking in opposing direction). This corresponds to **Criteria F2** the ADA Curb Ramp Design Checklist. Accessible route islands are often marked with crosswalk markings. **When the crosswalk is marked, the constructed curb ramp opening must be wholly contained within the crosswalk (Criteria Q).** *Curb ramp cut through in medians islands are therefore not to exceed 9 feet in width when it only serves pedestrians; the standard crosswalk marking is 9 feet when continental markings are used. Coordinate with the striping designer, when the clear width exceeds 9 feet to ensure ADA compliance for any marked crosswalk as larger markings may be permitted.*

When pedestrian volumes are expected to be high for a particular cut through crosswalk, widths above 5.5 feet are recommended and provide for greater pedestrian capacity in the

pedestrian access route. *The clear width for the accessible island should match the Pedestrian Zone width for the walkway it connects to. Clear widths exceeding 9 feet at a cut through median needs to be evaluated with engineering judgement to ensure drivers don't abuse the opening to perform illegal traffic operations such as U-turns or misconstrue the space as a narrow roadway entrance to an adjacent property along the highway.* Bollards are not recommended as a treatment to mitigate this concern.

Roundabout splitter islands typically introduce geometrics in the cut-through of the crosswalk alignment to discourage vehicles from entering it. Crosswalks at roundabouts must accommodate bicycle traffic through the splitter island and wider widths may be necessary based on the design user. Consult the Bicycle & Pedestrian Design Engineer for additional guidance on selecting design bicycle vehicles and refer to Part 900.

Curb ramps designed for shared use paths shall have a minimum width equal to the approaching share use path width. When the accessible route island is serving a shared use path, the curb ramp opening shall be equal to the shared use path it serves. This corresponds to **Criteria F3** on the ADA Curb Ramp Design Checklist. The shared use path is fully accessible to both pedestrians and bicyclists, and efforts to segregate modes with painted striping is not effective communication for the low vision and blind populations.

815.4.3 Gutter Flow Slope and Inlets

The gutter flow slope is the grade at the gutter flow line at the bottom of a Ramp Run 1 where storm water is collected. It is immediately parallel to the curb or street edge where water is conveyed to a drainage system. **Water cannot pool in front of curb ramps. Install inlets or provide another approved drainage mitigation upstream of any new curb ramp constructed.** Refer to the hydraulics design manual for designing inlets, calculating the spread distance, and depth of water during a design storm event. *Best practice is to design a gutter flow slope of at least 0.5 percent to convey storm water; however, some circumstances including crests and high sides of super elevated roadways can utilize a gutter flow slope of 0.0 percent.* Refer to Section 810 on walkway design hydraulics for additional information.

Figure 800-37: Water Accumulation at Curb Ramp



The maximum design gutter flow slope is variable based on the intersection control type. The intersection control type is based on the traffic control for vehicles. The intersection control type is determined during the design of the curb ramp system and determines the permissible measurement at the bottom of the curb ramp. You will need this information to complete the design of the curb ramp. Use ODOT’s Exhibit D in Figure 800-38 and Figure 800-39 to help determine common Intersection Control Types. Refer to Technical Bulletin RD21-01(A) for discussion on strategies to meet the gutter flow slope requirements on existing curb ramps that are altered and reconstructed.

The maximum design gutter flow slope for the three intersection control conditions are:

1. 1.5 percent at stop/yield intersections (SY)
2. 4.5 percent at signalized/uncontrolled intersections (SU)
3. Profile slope of the roadway at mid-block crosswalks (MB)

Design exceptions are required under Criteria D1, Criteria D2, and criteria D3 on the ADA Curb Ramp Design Checklist, when gutter flow slopes are not achieved at the curb ramp.

Criteria D1 pertains to intersections in the Stop/Yield (SY) condition, Criteria D2 pertains to the Signalized/Uncontrolled (SU) condition, and Criteria D3 pertains to the Midblock (MB) condition. This closely correlates to Criteria C1, Criteria C2, Criteria C3, and Criteria C4 for cross slope on the ADA Curb Ramp Design Checklist.

Figure 800-38: ODOT Exhibit D for Design Gutter Flow Slope Conditions

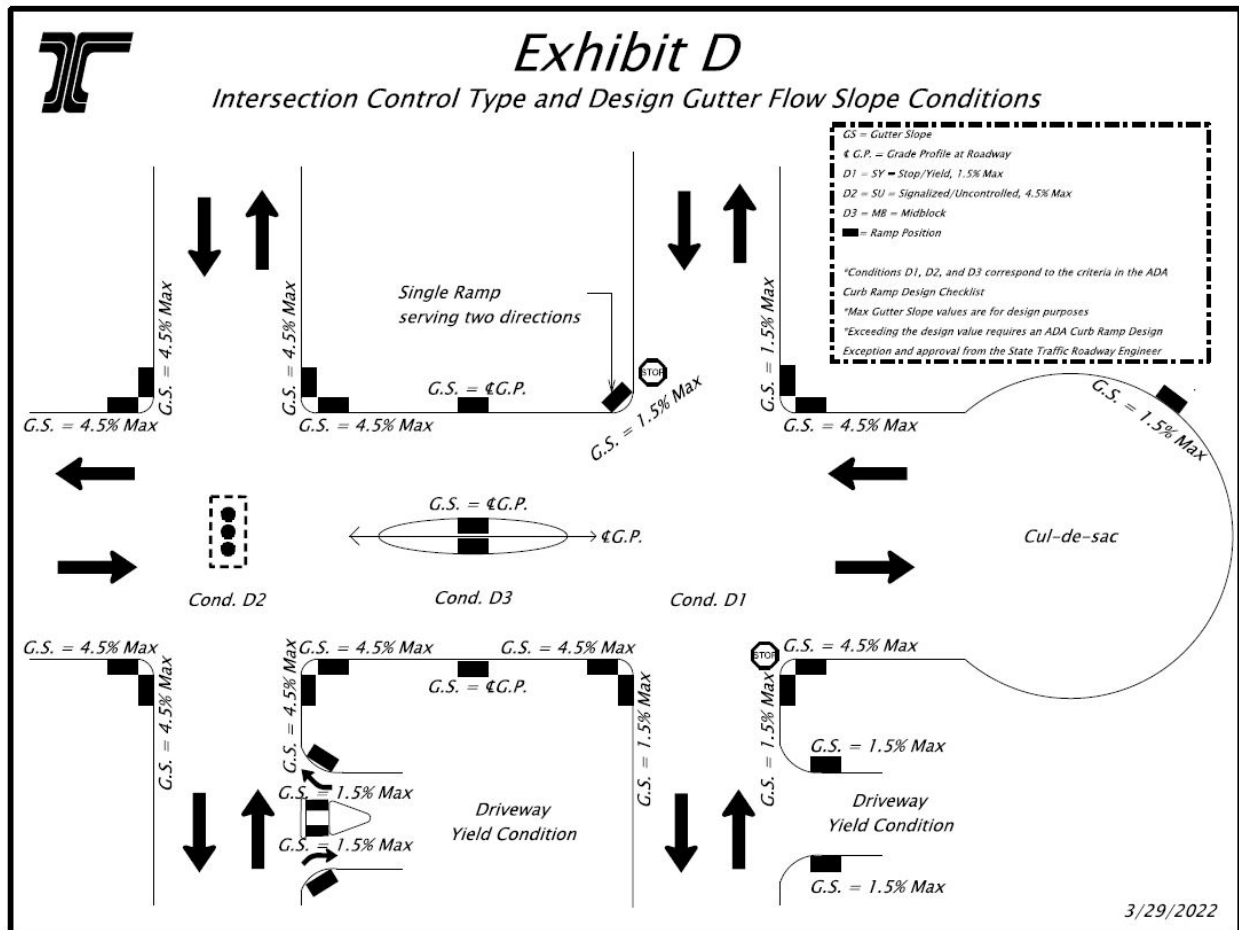
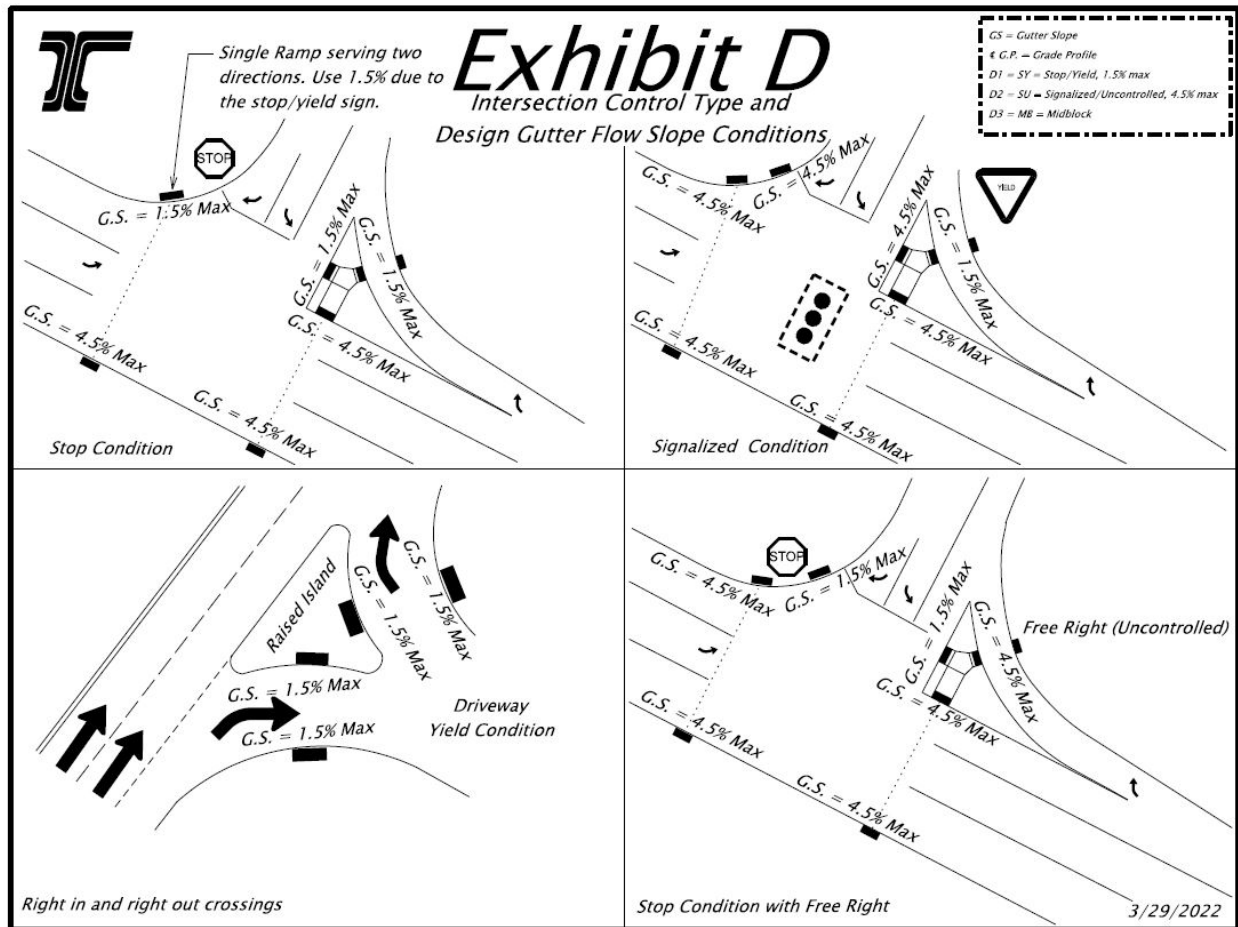

Figure 800-39: ODOT Exhibit D for Design Gutter Flow Slope Conditions for Right Turns



Provide an inlet upstream of the curb ramp or other approved drainage mitigation. Inlets and drainage grates are not permitted in the pedestrian access route for new construction of intersections. This corresponds to Criteria H. Alterations of existing roadways may be constrained on a rare occasion and an inlet may need to remain in the crosswalk. When an inlet cannot be relocated upstream of the curb ramp, installing an ADA accessible grate may be considered as mitigation.

Pedestrian access routes or circulation areas are not permitted to have horizontal openings exceeding 1/2 inch, allowing a 1/2 sphere to pass through in the direction of pedestrian travel. When there is not a dominant direction of pedestrian travel, the 1/2 inch opening cannot be exceeded in any direction. Accessible drainage grates are available, but not a standardized in the Oregon Standard Drawings. Contact the Senior ADA Standards or Senior Standards Engineer in the Traffic Roadway Section for further guidance. Addressing water conveyance and ponding at curb ramps is an ADA requirement. Coordination with the hydraulics designer for storm water collection is required for curb ramp design.

815.4.4 Cross Slope

The cross slope is the grade of a surface perpendicular to the running slope of the traversed surface in the direction of pedestrian travel. Determine the intersection control type for the crosswalk location as described in Section 815.4.3. **Cross slopes on curb ramps built within a private building site development or compound, have the ability to control the grading of site and should be able to achieve the pedestrian access route requirements of 1.5 percent design requirement.** See Section 820 for design cross slope requirements of building ramps. The strategies below address the unique challenges of providing accessible routes on the public right of way at intersections and crosswalks. There are five design conditions for cross slope within or adjacent to the curb ramp system components at a public crosswalk:

1. Entry into the Travelway at Ramp Run 1 and directional curb
2. The turn space and ramp runs excluding Ramp Run 1
3. Within an accessible route island
4. Transition panel
5. Pedestrian circulation area adjacent the pedestrian access route

Figure 800-40: Arrows Showing How the Cross Slope is Oriented Perpendicular to the Ramp Run

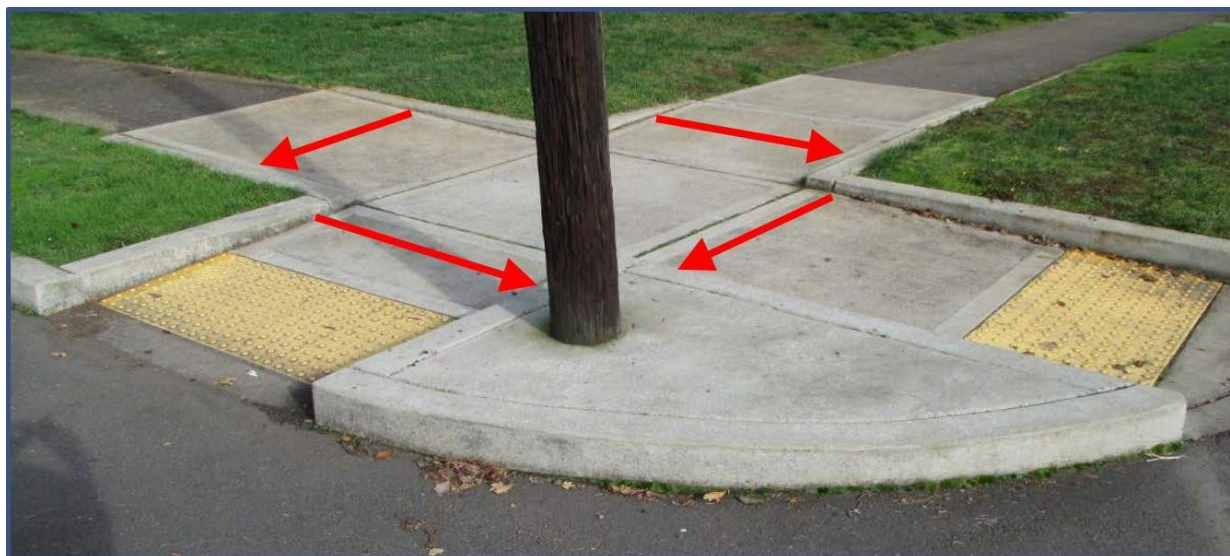

Ramp Run 1 and Directional Curb Cross Slope

The cross slope of ramp run 1 and a directional curb is based on the intersection control type. When the design gutter flow slope is allowed to be greater than 1.5%, based on the intersection control type, the cross slope of ramp run 1 is allowed to transition along the ramp run. This transition typically occurs from the level area or turn space to the gutter flow line by warping

the cross slope at a rate of 0.5% per foot in the ramp run and may include the directional curb component. **The cross slope on the ramp run or directional curb is not to exceed the maximum allowable gutter flow slope for the curb ramp system.**

Intersection traffic operations determine the design gutter flow slope value permitted for the intersection control type. When the intersection control type is not a stop control with a stop sign or yield sign, the gutter flow slope is permitted to exceed 1.5 percent. When this condition occurs, the cross slope transitions from the level area or turn space to the gutter line in a gradual manner by warping the cross slope. **A directional curb may be constructed on curb ramp systems on a radius to ensure a perpendicular grade break, Criteria T, at the bottom of the ramp run 1.** See RD905 for examples of the directional curb component. **Where present, the maximum cross slope of the constructed directional curb surface is the gutter flow slope (Criteria C4) permitted by the intersection control condition.** Refer to Section 815.4.3 on gutter flow slope design at the intersection as the directional curb design is interdependent with **Criteria D1, Criteria D2 and Criteria D3.** In some cases, the directional curb may have a warped cross slope designed. When warping is required, use the same technique to warp the panel as described for perpendicular ramp runs.

Warping cross slope on ramp run 1 to meet the gutter flow slope design requirement is permitted in this circumstance for some styles of curb ramps. This warping occurs on the perpendicular ramp run at the curb ramp entrance/exit. The standard warp rate for cross slope changes is 0.5 percent per foot of length on the ramp run. **Warp rates exceeding 0.5 percent per foot are not permitted when a new pedestrian facility or roadbed did not exist prior to construction of the curb ramp. Warping rates exceeding 1.0 percent per foot are not desirable and require further justification and documentation.** *Warp rates between 0.5 percent and 1.0 percent may be considered when site conditions are constrained with a curb ramp alteration on an existing roadbed.*

Design exceptions are required and often interdependent for cross slope and gutter flow slope. See the Table 800-6: Cross Slope 1 and Gutter Flow Slope Interdependencies for the criteria needing design exceptions listed on the ADA Curb Ramp Design Checklist **Criteria C** and **Criteria D.** **Criteria C1, Criteria C2, Criteria C3, and Criteria C4** are interdependent with the gutter flow slope and intersection control type; see Table 800-6.

Table 800-6: Cross Slope 1 and Gutter Flow Slope Interdependencies

Gutter Flow Slope (Criteria D)	Ramp Run 1 Cross Slope (Criteria C1)	Mitigation	ADA DE Needed & Criteria
D1 - Stop Yield (1.5%)	0-1.5%		No
	1.5% - 4.5%	Warping of Cross Slope Up to 4.5%	Need DE D1 and C1 >1.5%
	greater than 4.5%	Warping of Cross Slope > 4.5%	Need DE D1 and C1 >1.5%
D2 - Signalized & Uncontrolled (4.5%)	0-1.5%		No
	1.5% - 4.5%	Warping of Cross Slope Up to 4.5%	No
	greater than 4.5%	Warping of Cross Slope > 4.5%	Need DE D2 > 4.5% and C1 >4.5%
D3 - Midblock, Grade of Road 0% - 1.5%	0- 1.5%		No
	>1.5%		Need DE D3 and C1 >1.5%
D3- Midblock, Grade of Road 1.5% - 4.5%	0- 1.5%		No
	Exceeds 1.5% & Less Than Grade of Road	Warping of Cross Slope Up to 4.5%	No
	Exceeds 1.5% & Exceeds Grade of Road	Warping of Cross Slope > 4.5%	Need DE D3 > 4.5% and C1 >4.5%
D3 - Midblock, Grade of Road greater than 4.5%	0- 1.5%		No
	Exceeds 1.5% & Less Than Grade of Road	Warping of Cross Slope Up to 4.5%	No
	Exceeds 1.5% & Less Than Grade of Road	Warping of Cross Slope > 4.5%	Need DE C1 only > 4.5%
	Exceeds 1.5% & Exceeds Grade of Road	Warping of Cross Slope > 4.5%	Need DE D3 & C1 >4.5%

Turn Space, Ramp Run 2 and Ramp Run 3 Cross Slope

The constructed cross slope of a turn space and adjacent ramp run(s) 2 and 3 may not exceed 2.0%. Cross slope design values exceeding 1.5 percent require design exception approval. This corresponds to **Criteria C1** on the ADA Curb Ramp Design Checklist. *Design cross slopes for ramp runs in the curb ramp system between 0.0 percent and 1.5 percent for drainage conveyance.* See discussion in Section 810.5 for pedestrian access routes. Specified cross slopes shall be compliant anywhere along the ramp run surface.

Accessible Route Island Cross Slope

The cross slope within an accessible route island is dependent on the intersection control type. **At islands that are yield or stop controlled, the maximum constructed cross slope is 2.0 percent. Design the cross slope less than or equal to 1.5 percent for stop and yield conditions, this falls under Criteria C1.** At islands across an intersection crosswalk without yield or stop control, the maximum constructed cross slope is 5.0 percent. Design the cross slope less than or equal to 4.5 percent when the intersection is signalized or uncontrolled intersection conditions. This is **Criteria C2** on the ADA Curb Ramp Design Checklist (Form 734-5184). These islands are

typically used for right turn channelization shown in RD700s; refer to Figure 800-39: ODOT Exhibit D for Design Gutter Flow Slope Conditions for Right Turns for other examples.

Where a midblock crosswalk is provided, the cross slope within the accessible route island is permitted to match the street or highway grade. **Where highway grades are greater than 1.5 percent, design exceptions are required when the design cross slope of the pedestrian access route for islands at mid-block locations exceeds the highway grade (roadway slope).** This correlates to **Criteria C3** on the [ADA Curb Ramp Design Checklist](#) (Form 734-5184). Where the grade of the road is between 0% and 2%, the design cross slope is permitted to be up to 1.5 percent without a design exception. For example, if the road profile grade is 0.0 percent, the design cross slope of the pedestrian path can be up to 1.5% without a design exception.

Transition Panel Cross Slope

A transition panel is constructed to transition walkway segments from new construction to match existing conditions. Often cross slopes exceed 2.0 percent at the match point on existing non-conforming sidewalk or street crossings. **Utilize the warping standards to transition cross slope on transition panels when required for the curb ramp system design.** These are discussed in the preceding paragraphs and see RD722 for transition panel requirements. Transition segments of a walkway are not a component of the curb ramp system and should meet accessibility standards for new construction to the extent feasible. **Transition segments cannot make the overall pedestrian access route worse than pre-existing conditions under the ADA.** *Transition panels are typically at least 6 feet long to account for most construction conditions and irregularities in existing walkway cross slopes, and to keep the concrete panel square.* Square concrete panel are best practice to minimize cracking in concrete construction.

Pedestrian Circulation Area Adjacent to Pedestrian Access Route

The curb ramp system potentially includes portions of Pedestrian Circulation Area that are not part of the Pedestrian Access Route, such as the flares, hardscaped buffer zone and hardscaped frontage zone. The cross slope within these areas is not subject to 1.5 percent maximum design requirements. See Sections 810.3, 810.4 and 815.4.10.

815.4.5 Ramp Run

A ramp run is one of the ramp surfaces within a curb ramp system. A ramp run is a sloped surface within a curb ramp system designed to bridge vertical elevation changes in the pedestrian access route. Curb ramp systems can have more than one ramp run. Ramp runs can also occur on driveway surfaces and on building ramps. A ramp run may be parallel to the street, perpendicular to the street, or may be constructed at an angle on a street corner radius.

A ramp run is to be designed in a planar fashion; angle points and frequent grade changes are indicative of curvilinear construction. Ramp run surface construction is to be straight, free of

humps or sags, or other irregularities in the final surface. Ramp run alignment should not be curved as this creates compound slopes (both running and cross slope at the same time) like super elevation of a travel way. Curved ramp runs make it difficult to meet the cross slope requirements of an ADA pedestrian access route. **Design ramp runs with perpendicular grade breaks at both the top and bottom of the ramp run, free of lips or discontinuities.** This corresponds to the **Criteria T** on the ADA Curb Ramp Design Checklist (Form 734-5184). When the slope of the walkway or ramp run is under 5.0 percent running slope perpendicular grade breaks are less critical for mobility devices. When perpendicular grade breaks are not constructed, mobility devices cannot maintain 4 points of wheel contact on the surface, resulting in instability when navigating the path of travel. Power assisted devices often have the power assisted wheels in the front (front wheel drive), so front wheel contact is necessary to move forward.

The preferred alignment of a ramp run 1 is such that the centerline alignment of the panel is parallel with the intended crosswalk and markings. This is good for all users of the walkway and crosswalk, but particularly important for those with vision impairments. While navigating the walkway, changes in direction along the walkway requires people to reorient themselves to align with the adjacent traffic. While many low vision and blind travelers can use the sounds of traffic, deaf-blind pedestrians cannot rely on the same cues to orient themselves with the crosswalk. Physical cues (i.e., curbing, edge delineation, tactical guide strips) that can be detected typically by white canes are needed for deaf-blind pedestrians. When the ramp run is not aligned parallel with the intended crosswalk:

- this adds complexity for pedestrians with disabilities
- it increases operational crossing distances/time for the pedestrian using the crosswalk
- **it requires an additional clear space for pedestrians to reorientate themselves in the roadway free from parallel vehicular traffic in the shoulder (Criteria M)**

Each ramp run is assigned a position number for the curb ramps system. The entry or exiting ramp run to the curb ramp system is assigned the position number 1. The additional ramp runs in the curb ramp system are numbered counterclockwise from the turn space or level landing. The maximum number of ramp run positions for a curb ramp system is three based on ODOT's asset methodology.

Figure 800-41: Four Ramp Runs on One Curb Ramp System



The ramp running slope is the grade of a surface that is parallel to the direction of pedestrian travel on a curb ramp run. Figure 800-42 below has four running slopes. *Ramp running slopes are designed between the slope range of 0.0 percent to 7.5 percent. A design exception is required for ramp running slope exceeding 7.5 percent. Ramp running slopes may not exceed 8.3 percent in final construction.* This corresponds to **Criteria B1** on the ADA Curb Ramp Design Checklist (Form 734-5184). Running slopes can be positive or negative relative to a horizontal plane. Flatter slopes are generally more accessible in that it requires less work or energy by pedestrians to traverse the surface of the ramp run.

Figure 800-42: Running Slope Arrows on Ramp Runs

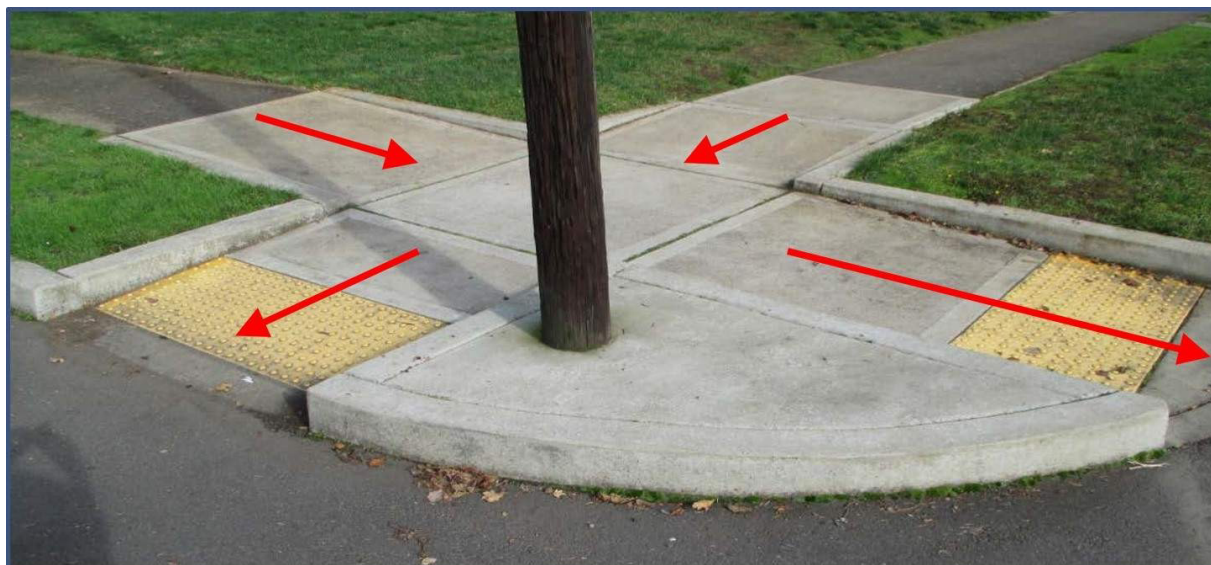

The ramp run length is the horizontal distance measured on the ramp run. Each ramp run is measured for length. The longest distance measured is recorded on the inspection form. During inspection, the ramp run length data field is used to capture the general length of the ramp runs (including the directional curb component when present). *While ADA doesn't describe a minimum length for ramp runs, best practice is to construct a ramp run length of at least 3 feet to ensure mobility devices don't span multiple surface planes along the pedestrian access route. The wheel point of contact distance is typically 24 inches in either direction, however it varies based on mobility device. Installation of the detectable warning surfaces also requires some nominal distance to install without bridging a grade break, so a distance of at least 2.5 feet is recommended for short ramp runs that meet the travel way (Ramp run position 1 for ODOT). Design the length of the ramp run so it matches an existing sidewalk joint nearby and provides square concrete panels when chasing grade to match into an existing walkway. When the design running slope exceeds 7.5 percent, design a ramp run length of at least 15.2 feet to mitigate the steep slope first.* This is often the mitigation for ramp runs requesting exceptions under the ADA Curb Ramp Design Checklist (Form 734-5184) **Criteria B1**. In some cases, it may not be feasible to achieve 15.2 feet and the physical constraints would be added to the justification for a design exception request. *Additionally, as a mitigating measure, consider a wider pedestrian access route so the user can weave down the ramp run back and forth at a more comfortable slope (this is more applicable to manual wheelchair users or walking cane users).*

Provide at least 5.0 feet between ramp runs and between parallel ramp runs along the constructed pedestrian access route (Criteria P1). Provide 5 feet of separation on reversing sloped surfaces to the extent practical and evaluate the resulting algebraic grade difference if no separation is provided. *Designs should not exceed 11.5 percent algebraic grade difference.* Deviations for the separation distance is requested under the ADA Curb Ramp Design Checklist (Form 734-5184) **Criteria P1**. Reversing sloped ramp runs create a peak in the pedestrian access route which can become a physical barrier for passage by some types of mobility devices. Many power-assisted wheelchairs and scooters only have 1 inch of vertical clearance. Refer to the standard drawing(s) for driveway construction (See RD700s) where this circumstance is mostly likely to occur. The 5.0 feet of separation between the parallel ramp runs may also serve as the passing space required for pedestrian access routes, and when the space is level, it provides a resting opportunity for people using mobility devices. **Turn spaces (level areas) for curb ramps provide the same function however the design standard is to provide at least 4.5 feet between the ramp runs in most configurations.** See discussion in the Turn Space and Level Landing subsection in Section 815.4.

815.4.6 Directional Curbs

A directional curb may be present on curb ramps with a radius. It is typically triangular-shaped, and it is the area between the lower ramp run grade break and the back of curb before entering the travel way. The directional curb is an extension of the typical roadway curbing surface so

that ramp runs can be configured to align parallel with the intended crosswalk and provide a perpendicular grade break for the ramp run. This allows for the preferred ramp run 1 alignment to be constructed (parallel with the intended crosswalk it serves) as discussed in the Ramp Run subsection in Section 815.4.

See RD905 for example illustrations of the directional curb. ODOT gave this area a specific name and this is new terminology to identify a component of the curb ramp system. **When present, the running slope of the directional curb is required to be less than or equal to 4.9 percent at final construction.** Running slope measurements are parallel to the ramp run. **Provide directional curbs with running slope between 1.5 percent to 4.0 percent to match the curb running slope of the depressed curb and gutter section, reduce the number of grade breaks along the pedestrian access route, to provide drainage conveyance and reduce sediment collection on the curb ramp (Criteria B4).** Directional curbs are generally constructed in a manner that resemble a shallow V-ditch or Valley Gutter as shown in RD700s; rebar is not needed. Designers must evaluate the geometrics to ensure ponding or accumulation of water does not occur locally on the directional curb.

Figure 800-43 Oregon Standard Drawing Valley Gutter

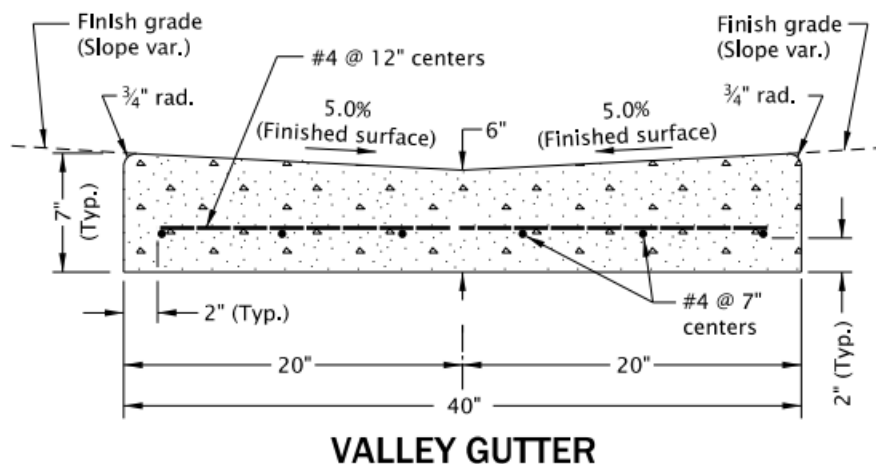

The length of the directional curb varies based on the geometrics of the intersection corner radius. The directional curb design provides a connection to the travel way and provides a perpendicular grade break at the bottom of the curb ramp run (Ramp run position 1). This grade break helps facilitate design cross slopes that keep the ramp run planar on the surface that is directly adjacent to it. Lengthen the directional curb in areas where pedestrians using mobility devices may need additional space to remain out of the travel way when there is no shoulder in the Travelway Realm. Lengthen directional curbs when ramp runs are steep due to terrain to provide a relatively flat area for ascent or descent. Avoid excessively long directional curb layouts for curb ramps.

Grade breaks are set behind the detectable warning surface panels when flares are constructed with a directional curb, see RD900s. Detectable warning surface product installation is not very constructible over grade breaks or over warped surface planes; determining the location of the grade break at the bottom of the ramp run 1 influences your design footprint. Directional curbs can be designed and constructed monolithically with the curb and gutter if a specific detail is provided in the contract plans, placing the cold joint at the bottom of the gutter pan.

The constructed directional curb cross slope cannot exceed the gutter flow slope requirement at the intersection, based on the intersection control type (Criteria C4). Remember, there are three possible intersection control types that determine the acceptable gutter flow slope. In some cases, the directional curb may have a warped cross slope designed. When warping is required, use the same technique to measure the warp panel as described for perpendicular ramp runs.

Figure 800-44: Curb Ramp System with a Directional Curb



815.4.7 Curb Running Slope

The curb running slope is the surface slope on the top of the curb that is cut through and typically depressed to connect to the ramp run, directional curb, gutter pan, or travel way roadway surface. The curb running slope is the slope of the surface perpendicular to the gutter flow line, excluding any gutter pan adjacent to the street. The curb running slope is the grade

expressed as a positive or negative measurement with positive slopes toward the street gutter line.

Utilize DET1752 for designing curb running slopes on the curb ramp system. Curb running slopes provides the “V” section for drainage in most cases. *Design the curb running slope with a slope of 4.0 percent for most curb ramp configurations to ensure water does not pond or collect debris at the curb ramp entrance/exit (Criteria B3).* Curb running slopes that are designed with slopes of 0.0 -1.5 percent in most curb ramp configurations creates a trapezoidal channel section at the bottom of the entrance/exit of the curb ramp. This results in poor drainage conveyance and sediment collection at the curb ramp. *Design the curb running slope with a slope of 1.5 percent when building a raised crosswalk or for super elevated crosswalks as ponding is not a concern; additional grade breaks are an inconvenience along the pedestrian access route (Criteria B3).* When the curb ramp running slope is opposite of the ramp running slope (negative) and it creates a “v channel” at the back of the curbing, it will fail the curb ramp. Water will not drain and it will pond. Reversing sloped designs should be rare and need to incorporate other drainage mitigation measures to ensure the storm water does not enter the walkway or private property.

Figure 800-45: Water Accumulation at Curb Ramp on Landing/Turn Space



When a curb running slope over 4.0 percent is desired for the site, monolithic curbing and ramp run section is required. Situations when this may be appropriate include travel ways with profile slopes less than 0.5 percent. Curb running slope over 8.3 percent will result in a non-compliant curb ramp system. **Design exceptions for curb running slopes over 7.5 percent should be rare.** This corresponds to **Criteria B3** on the ADA Curb Ramp Design Checklist (Form 734-5184).

When monolithic curbing and ramp runs are designed for construction, the grade break is located at the gutter line in these circumstances. Constructing two design slopes on the ramp

run and curb running slope is not practical in monolithic construction. When curb running slopes are designed over 4.0 percent, the ramp running slope must be equal and constructed monolithically ensuring there is not any inconsistency in the planar surface of the pedestrian access route. **The grade break must be perpendicular to ramp run 1; see Criteria T** on the ADA Curb Ramp Design Checklist (Form 734-5184).

815.4.8 Counter Slope

Curb and gutter is a part of the curb ramp system. Many rural locations do not have existing curb in place and will remain rural in character with separation from the travel way realm with for example a grassy sloped surface or ditch. The same basic requirements for counter slope apply to the connection to the crosswalk for the pedestrian access route. Where there is no Curb Zone, the surfaces adjacent to each other still must be flush and meet the counter slope requirements at the edge of roadway/gutter line.

Counter slope is the grade of the street or gutter pan perpendicular to the curb or street edge. Provide a counter slope less than or equal to 4.0 percent at the curb ramp opening, Criteria E. Where there is no concrete gutter, measure the counter slope within 2 feet of the curb. Where concrete gutter is present, measure the slope of the concrete gutter pan. Concrete gutter pans may vary in width depending on the Curb Zone and travel way needs. See discussion on the Curb Zone in Section 810.2. The measurement will be taken perpendicular to the curb for consistency as the pedestrian path of travel may vary based on the receiving curb ramp location. An unmarked crossing or offset curb ramps at the crosswalk will make it impossible to determine the exact path of travel of a pedestrian. In most cases, it is presumed mobility devices will approach the entrance perpendicular to the grade break at the curb.

On projects where construction only encompasses curb ramp retrofits and remediation, pavement reconstruction is limited to the surrounding area of the curb ramp, in most cases. In that circumstance, the adjacent surface slope for the pedestrian access route/street crossing cannot reduce existing accessibility performance. **The constructed roadway cross slope of the highway street crossing (counter slope adjacent to the gutter pan) is to be no steeper than 5.0 percent, except when existing conditions on the roadway already exceed that slope.** Note, that slope differential calculations may be relevant information when requesting a design exception for counter slope **Criteria E** on the curb ramp design exception to determine the functionality and usability of the pedestrian access route.

Figure 800-46: Curb Running Slope Convention

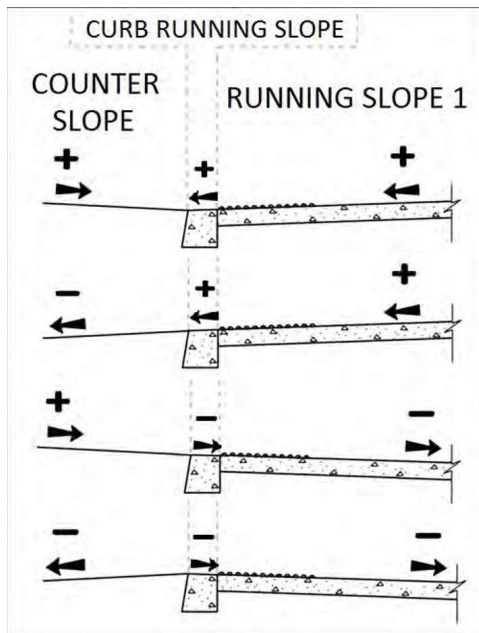

The positive slope convention is based on a typical curb ramp system that conveys storm water at the gutter line in a “V” section. A “V” section occurs when the counter slope, the curb running slope, and the ramp running slope are configured to collect water with the gutter line as the lowest elevation point. Slope conventions are determined from the gutter line. There is a positive or negative sign convention for slopes. Sloping towards (+) the gutter line is positive. Sloping away (-) from the gutter line is negative.

815.4.9 Lips

Flush connections are required at grade breaks along the pedestrian access route and pedestrian circulation areas. Note that at grade breaks, the surface is designed to be flush. Grade breaks occur when there are two different slopes on two different planes that intersect each other.

Lip height is the vertical difference between two adjacent surfaces, measured within the curb ramp proximity limits. A “lip” is a vertical discontinuity along the pedestrian access route, walkway, or pedestrian circulation areas. The lip heights are recorded when the surface slopes that meet at a grade break are not flush. Lips can be anywhere within the curb ramp system proximity limits that includes ramp runs, level areas, turn spaces, and transition panels on the sidewalk. Lips can occur from many causes including differential settlement of the concrete panel, where two different surfaces meet, and with poor construction methods.

Figure 800-47: Locations Where Lips Might Occur

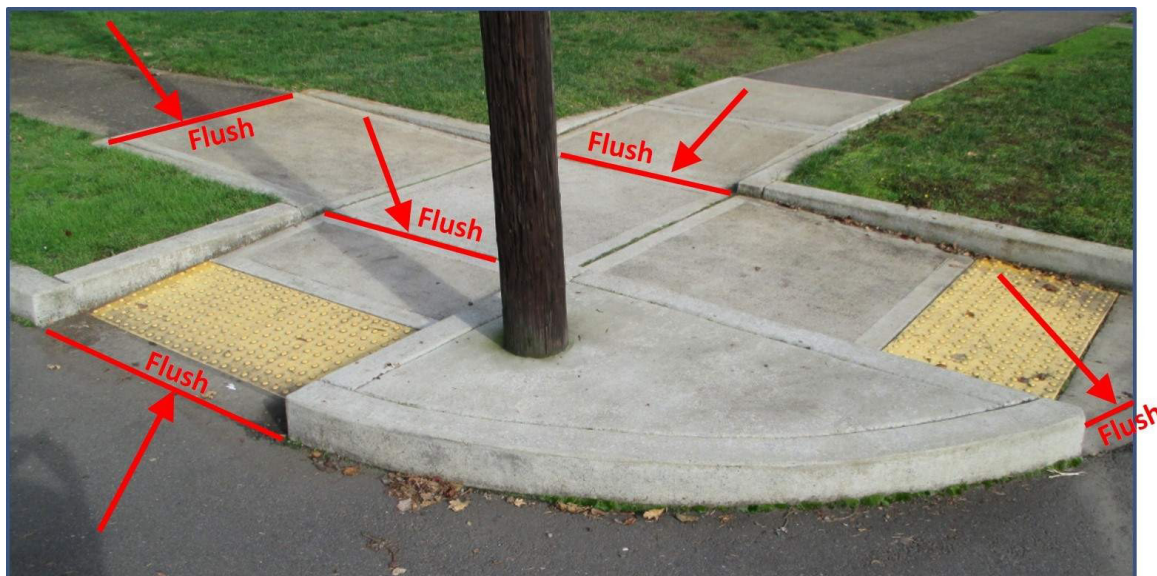

Curb returns typically have a varying height in the buffer zone adjacent to ramp runs when the buffer zone is not intended to be a part of the pedestrian circulation area. If not properly designed, the curbing would be considered an unexpected “drop off” in the pedestrian path of travel or circulation area.

815.4.10 Flares

Flares are a hard walkable surface that transitions the sidewalk down to the curb ramp opening adjacent to the pedestrian access route. **Curb ramp flares are part of the pedestrian circulation area and shall not have vertical discontinuities or lips.** When present, flares provide a hard surface and increase the pedestrian circulation area for individuals to stand on when waiting to cross the street. Objects such as signs, poles, utility valves and fire hydrants may be installed on a traversable flare. These types of objects are permitted to reside within the flared surface. They do not prohibit a pedestrian from walking across the flare. Flares provide a transitional surface for snow plowing or street sweeping operations when the curbing is obscured. *Flares may be constructed adjacent to a curb ramp run next to the buffer zone when it consists of softscape materials.*

All flare slopes (both traversable and non-traversable) are measured and cannot exceed 10.0 percent grade when constructed. This corresponds to **Criteria G1** on the ADA Curb Ramp Design Checklist (Form 734-5184). *Flares may be designed within the range of 0.0 to 9.5 percent.* **Provide at least 1 foot of constant height curb exposure (reveal) between adjacent flares on curb ramp systems.** This corresponds to **Criteria G3**. *Recommended design value is 15 inches, to ensure 1 foot of separation is achieved during final construction.* **The minimum reveal height or exposure shall be at least 3 inches between the two curb ramps when constructed.** This

corresponds to **Criteria N** on the ADA Curb Ramp Design Checklist (Form 734-5184). The area between the curb ramps provides multiple functions at the intersection including:

1. hydraulic drainage conveyance
2. pedestrian detectability with a white cane
3. visual and detectable distinction between the curb ramps
4. edge delineation for vehicles turning at the intersection.

ODOT construction practices do not typically call out monolithic construction of curb ramps with the curbing, so top of curbs and flare panels are inspected because they are typically two separate concrete pours. They should be flush at finish construction.

Traversable surfaces are hard surfaces that a pedestrian can walk on and could be constructed as accessible routes. Non-traversable surfaces are not suitable for mobility devices to travel over. Refer to the definition of hardscaping and softscaping to describe the adjacent surface installed or constructed next to a curb return or flare in the curb ramp system. Softscape surface types that might be constructed adjacent to a flare could include but are not limited to loose round durable rock, grass or native seed, lava rock, or planted areas with bark dust. Hardscape surfaces include but are not limited to colorized PCC, stamped patterning, tooled patterning, brick or unit pavers.

Curb returns may be used in lieu of a flare if designed appropriately to convey to all users that the area adjacent is not a walkable surface or is physically obstructed. When a curb return is designed, the best practice is to utilize softscape landscape treatments. This corresponds to **Criteria G2** on the ADA Curb Ramp Design Checklist (Form 734-5184). Non walkable materials such as bark, wood chips, loose round durable rock, sod and planted areas provide information to the pedestrian that this is not their area to walk on and is a part of the Buffer Zone.

Fixed objects are not desirable in the curb ramp system as these are within the clear zone for errant vehicles. Remove fixed objects to the extent practical to improve sight lines and pedestrian visibility. *Engineering judgement must be used to determine what fixed objects are utilized in lieu of softscape materials to keep pedestrians walking along the designed, planned, or intended path of travel or pedestrian access route.* Fixed street furniture including fencing, railings, and clusters of vertical objects such as fire hydrants, signs, and utility poles may be sufficient to deter pedestrian travel over the curb return. Gaps between vertical objects exceeding 24-30 inches can be perceived as a clear opening to continue along their path and may lead low vision and blind travelers to a sudden unexpected drop at the curb return. The top of the ramp runs when a curb return is planned needs to be delineated as this is where the lip and drop begins in the pedestrian circulation area.

815.4.11 Snow Curb Return

In locations where the curb ramp has raised curb returns frequently exposed to snow removal equipment, a snow curb return design may be used. During snow removal and maintenance operations on streets with frequent snowfall events, curb returns with vertical and abrupt edges are frequently damaged. Damage may occur to both the maintenance equipment and the walkway. A snow curb may prevent damage to the curb return and curb ramp system by providing a sloped surface for plow blades to transition up and over the curb. Effective snow removal is required to maintain pedestrian functionality of the street and crosswalk during the winter months.

Snowfall accumulation is predominant in the mountain ranges December through April at elevations above 4500 feet in Oregon. See Figure 800-48 for snow curb return design details. Standard curb ramp flared sides can serve the same purpose of preventing damage to the curb ramp system during snow removal. The snow curb return was developed for use by ODOT in 2020 for locations where a flared side design is not provided. See Section 810.2 for curb and curb zone design requirements.

Many of the curb ramps constructed are a combination style curb ramp where the following standards will be met as described in other sections of the manual with the modification to install a snow curb return.

- 1. Buffer zone cross section width (depths) of at least 2 feet will be provided consistent with the standards (2 feet per RD721) or as required by Urban Design Concurrence if applicable.**
- 2. At least 12 inches of constructed full curb reveal between adjacent snow curb returns will be provided between two curb ramps (Criteria G3 on the curb ramp design checklist (Form 734-5184)).**
- 3. A minimum curb reveal constructed at the gutter line of 3 inches will be provided for drainage conveyance and physical detection by white canes (Criteria N on the curb ramp design checklist (Form 734-5184)).**
- 4. Five feet of constructed physical separation will be maintained between curb ramps as shown in RD936 Option CC- 3 for curb ramps.**

Figure 800-48: Snow Curb Return

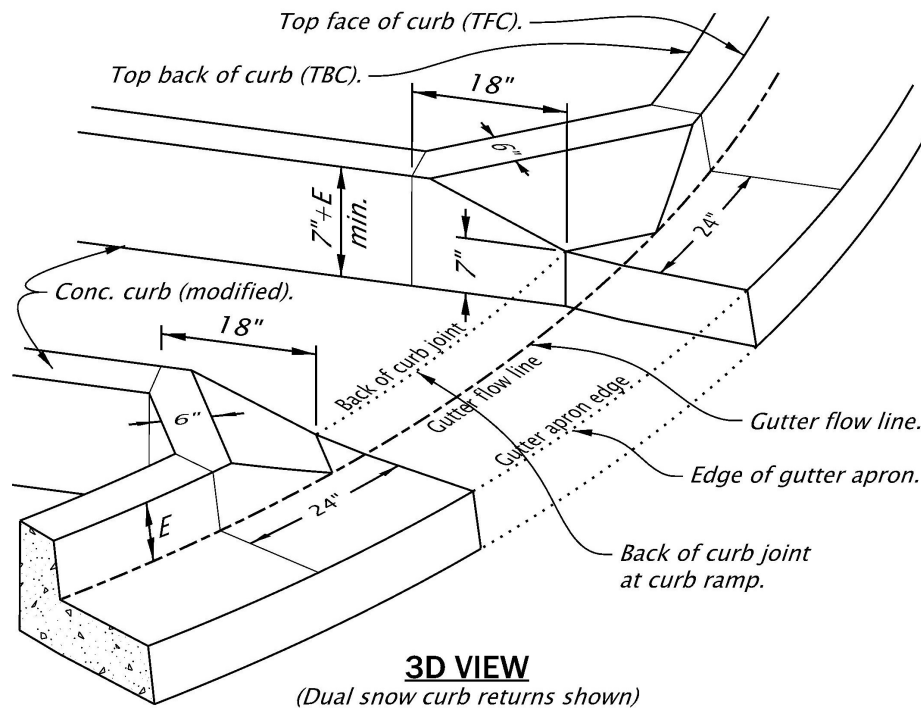

SNOW CURB RETURN NOTES:

1. Details show potential orientations of curb/gutter & curb ramps. See curb ramp detail sheets for specifics.
2. Between adjacent snow curb returns, allow 12" min. of curb length with E=6" nom. (E=3" min.) unless otherwise shown.
3. For curb details not shown, see dwg. no. RD700 and plans.

SNOW CURB RETURN

(As directed by Engineer.)

815.4.12 Turn Spaces and Level Landings

Turn Space is an area to allow mobility devices to change direction along the curb ramp or in the pedestrian access route, which are designed to be level. Level landings offer a place to rest without the fear of rolling. **Both features are designed with cross slopes 1.5 percent perpendicular to each other in both directions of pedestrian travel.** This corresponds to **Criteria J1. Turn Spaces/Landings are required to access public building entrances.** Section 820 discusses building ramp design.

Design a turn space and level landing at least 4.5 feet wide and 5.5 feet deep full width in the crosswalk direction in curb ramp design (Criteria J3) when there is a vertical obstruction at the back of the turn space. An obstruction may be but is not limited to a vertical object such as

a curb at the back of sidewalk, signal equipment foundation that is not flush, sign, building, or pedestrian railing. **Design at least 4.5 ft. wide by 4.5 ft. deep full width of the curb ramp when a turn space and level landing is not obstructed but has an adjacent flush surface constructed.** The flush surface is typically embankment material and at least 1 foot deep, see RD700s. This corresponds to **Criteria J2** on the ADA Curb Ramp Design Checklist (Form 734-5184).

Wheel contact points for a typical power assisted wheelchair comprises of at least a 48 inch circle on a zero turn device (meaning the device pivots about a single point when turning). A turn space cannot be too large for mobility devices, as larger areas provide easier operation and accommodate a wider range of mobility devices. Designs with irregularly shaped enlarged turn spaces and level area can aid in the design of curb ramps and facilitate two separate curb ramps at a corner when the space is shared by each curb ramp. See RD900s. *Turn spaces and level area should be free of obstructions when it serves multiple functions and is enlarged to provide access to the pedestrian push button.*

Figure 800-49: Wheelchair Maneuvering for Turns

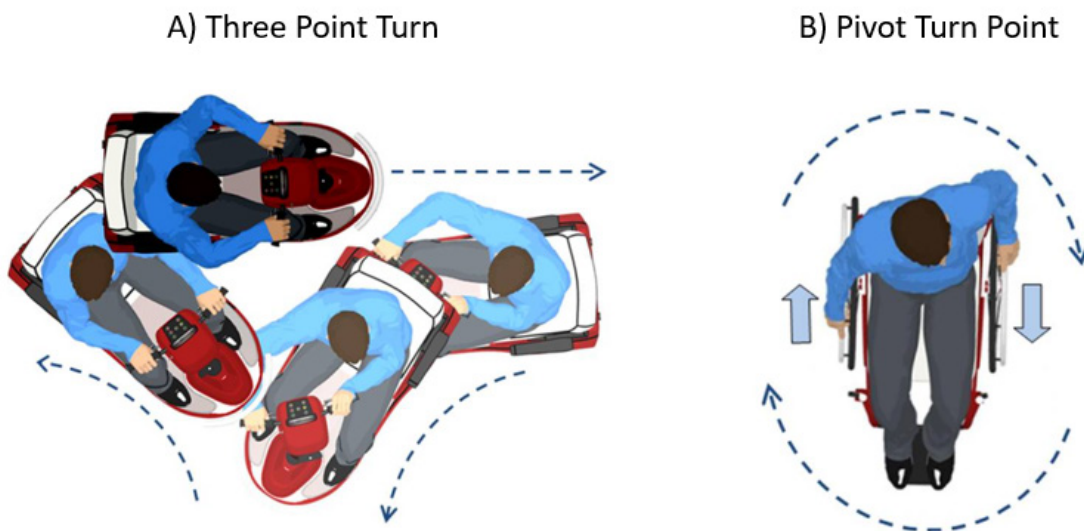

Figure Source: US Access Board Guide to the ADA Accessibility Standards

Level landings must be coordinated with the pedestrian push button range height. **The vertical range height for the pedestrian activated push button is between 42 and 48 inches from the center of the face of pedestrian push button.** This corresponds to **Criteria K2** on the ADA Curb Ramp Design Checklist (Form 734-5184). Coordination with the signal designer is required to ensure both disciplines are meeting the design requirements for push buttons and the curb ramp. *Curb ramp details involving a signal require review from the State Traffic Signal Engineer.* Refer to the Traffic Signal Manual as needed, as there are instances when a lower range height is appropriate and requires documentation. This might include a CQCR request or

a signal in an area serving a high population of children, such as a school crossing or rectangular rapid flashing beacons. The reach-range height for children is lower when seated in a wheelchair in comparison to typical adult. ADA provisions and recommendations when designing for accessible features for children are slightly different. Consult the Senior ADA Standards Engineer when designing specifically for children.

815.4.13 Clear Space

Provide a 4-foot by 4-foot clear space at the grade break at each end of a ramp run to ensure the turning maneuver can be accommodated along the pedestrian access route. *Clear space for the pedestrian access route is not required to be level, although as level as practical is desired.* **Provide a 4-foot by 4 foot clear space at the bottom of the curb ramp that is outside the parallel vehicular path of travel and within the crosswalk.** This corresponds to **Criteria M** on the ADA Curb Ramp Design Checklist (Form 734-5184). When the curb ramp is designed to be directional, ensure the clear space is available within the marked crossing lines. Single diagonal ramps must also provide a clear space free from vehicular traffic. The shoulder or bike lane may be used to provide the clear space. When there is no roadway shoulder, the radius of the intersection corner must be designed so that the mobility device can turn in the clear space outside of the traveled way of both streets.

Clear space for activating a pedestrian push button should be on a level landing and may overlap the level turning space. See **Criteria L2** on the ADA Curb Ramp Design Checklist (Form 734-5184). Reach and range height criteria originate from nearest prepared surface. These may include turning space, sidewalk, or paved shoulder.

Design the clear space utilizing the wheelchair design vehicle in coordination with the pushbutton. **The horizontal reach distance is not to exceed 10 inches from the center of the pushbutton face where installed, along the 4-foot edge of the wheelchair design vehicle clear space.** This corresponds to **Criteria K1** on the ADA Curb Ramp Design Checklist (Form 734-5184). The level clear space size varies based on the design for accessing the pedestrian push button as follows:

- **Criteria L1:** Where a wheelchair back-in/head-in maneuver is required, provide at least 3 feet by 4 feet clear space of prepared surface. Where a wheelchair back-in/head-in maneuver is NOT required, provide at least 2.5 feet x 4 feet clear space of prepared surface.
- **Criteria L2:** Do not exceed 1.5 percent maximum design slope for the clear space in both directions on the prepared surface.

Where **the push button is in an alcove condition, the width of the clear space for the parallel approach shall be at least 5.0 feet at finished construction.** Alcove conditions occur when the space is confined on three sides partially, or completely and the depth is 15 inches or larger.

Minimum design dimension of a pedestrian pad to access a pushbutton in a rural setting should be 5.2 feet x 5.2 feet to account for entry, exiting, turning and activation of the pushbutton on the pedestrian pad as this is an alcove condition.

815.5 Curb Ramp Details in Contracts

Refer to current Technical Bulletin RD17-02(B) and/or the ODOT Roadway CAD Manual. Review DET1720 and DET1721 for Curb Ramp Detail requirements and instructions.

815.6 Curb Ramp Inventory and Inspection

Refer to the ODOT ADA Curb Ramp and Push Button Field Guide and the ODOT certification training materials for curb ramp inspection. The certification course is three parts and available online for designers and inspectors located at the ADA Asset and Inspection webpage.

Section 820 Building Ramps

“Public entrances” include all entrances except those that are restricted or that are used exclusively as service entrances under the ADA.¹⁴ **Public entrances are required to be accessible.** Building ramps serve as the connection to the walkway when there is an elevation difference with the public entrance. **Directional signs with the international symbol of accessibility are required to be posted to direct users to the location of the accessible entrance at each inaccessible public entrance.**¹⁵ Refer to the illustrations below for general building ramp requirements and applicable regulation sections.

¹⁴ Section 206.4 2010 ADA Standards

¹⁵ Directional Signs at Inaccessible Entrances, see regulation section 216.6

Figure 800-50: ADA Building Ramps Accessible Routes Illustration, source US Access Board

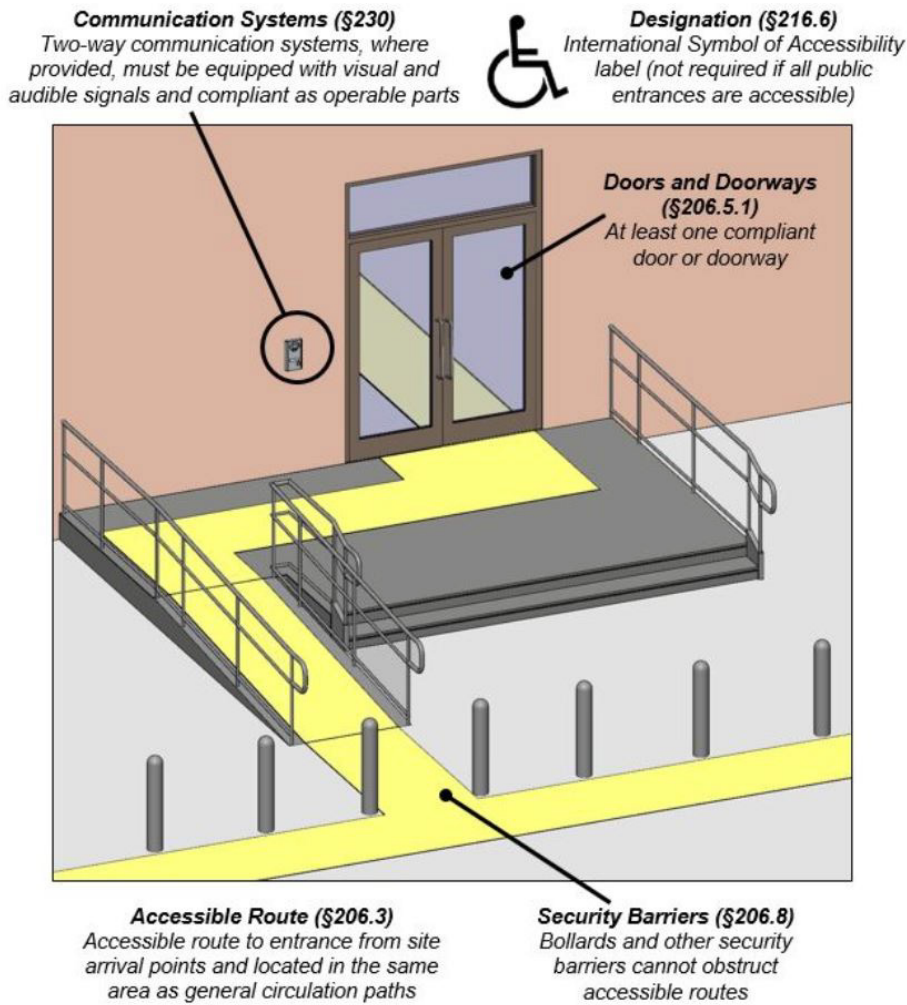
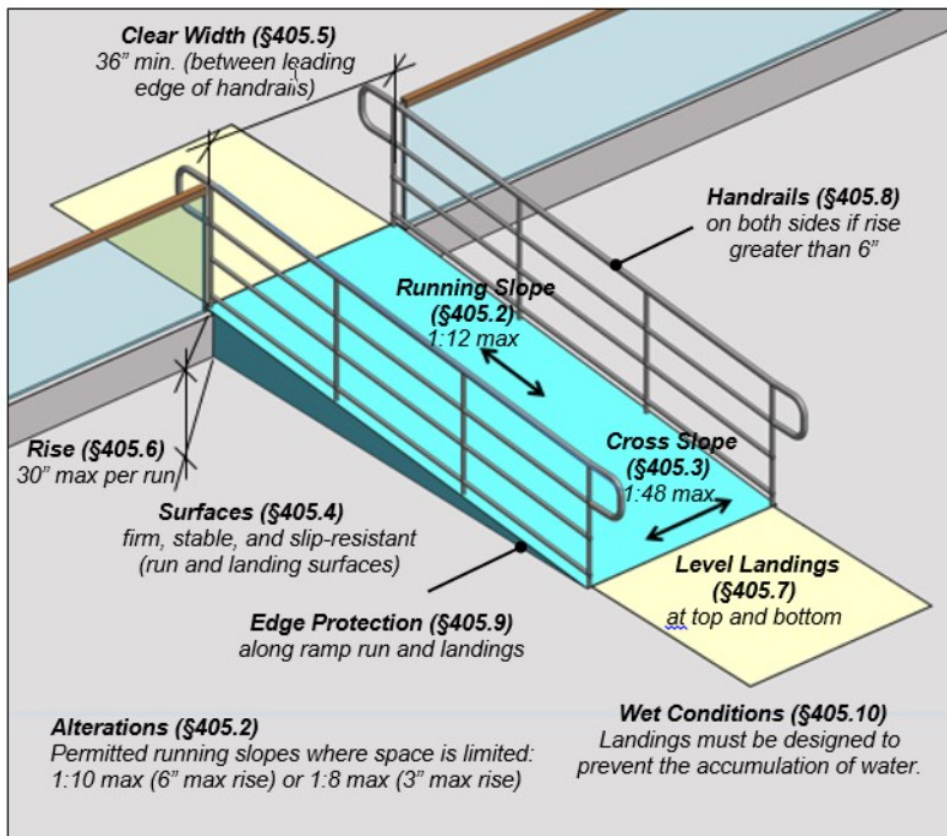

Figure 800-51: ADA Building Ramps Illustration, Source US Access Board and CFR



Building ramps have similar requirements as a curb ramp system. **The cross slope and running slope requirements are the same as curb ramps.** See discussion in Section 815. **Flush connections are required at grade breaks, and grade breaks are to be perpendicular the ramp run.** Level turning areas and landings are required at the top of building ramps or when any change in direction occurs.

Turning and landing areas are designed at least 62 inches square to accommodate a variety of door opening operations and maneuvering clearance, in addition to the space needed to change directions with the handrail obstruction. When space is constrained, consult the local building code division for applicable state and local ordinances and seek advisement from the Senior ADA Standards Engineer. Documentation for design exceptions on building ramps is captured on the general design exception form.

Handrail is used for pedestrian access along a pedestrian access route to navigate elevation changes on a building ramp. **ADA requires that building ramps with a rise greater than 6 inches include handrail.** Details are provided in RD770 & RD771 for handrails. RD770 handrail is sufficient for these conditions.

Section 821 Tactile Walking Surface Indicators

Tactile walking surface indicators are a means of providing effective communication and have been developed primarily to aid individuals who have low vision or are blind, while other pedestrians may also benefit from them. Tactile walking surface indicators have two primary functions. One function is to alert pedestrians and draw attention to where moving vehicles, transit services, or rail cars are operating. The second function is to guide pedestrians to a point of interest, to follow a path of travel, or to delineate edges. All tactile walking surface indicators are meant to be walked on, are designed to be distinguishable underfoot, provide contrast from other walking surfaces, and to not impede mobility devices from crossing them. This strikes a balance of needs for various users to provide the intended function. Tactile walking surface indicators are somewhat equivalent to braille underfoot, therefore careful, and consistent use is important to provide effective communication.

Tactile walking surface indicators are available in a variety of colors and shapes to meet the needs of the walking environment in both indoor and outdoor applications. Using tactile walking surface indicators in colors that contrast with the surrounding environment and are used in a consistent manner serves people who have some functional vision.

The various shapes, textures and materials provide different vibrations and auditory cues to those using a white cane for detection and differentiation compared to the adjacent walking surface materials. As an example, rolling or tapping a white cane over carpet, tile, or concrete will make a different acoustic sound and vibration that are distinct, thus differentiating them from each other. Tactile surface patterning and placement should be placed in a way to communicate a clear and consistent message. Tactile walking surfaces indicators must be slip resistant for pedestrians and can't impede proper drainage of walkways.

The United States Access Board provides and sets standards for the use of tactile walking surface indicators to meet the accessibility requirements of pedestrian facilities. Detectable warning surfaces with a raised truncated dome pattern (dots) is used for the warning and attention pattern. The detectable guide strip is used to guide an individual to a point of interest, follow a path of travel or use as edge delineation. The requirements for the installation of the detectable warning surfaces have undergone significant research and development for use; however, detectable guide strip requirements are still evolving. Review Section 821.2 for considerations when designing for various abilities.

821.1 Detectable Warning Surface

The detectable warning surface standard consists of a raised truncated dome pattern set at a prescribed height and center to center spacing along with other stipulations as prescribed by the United States Access Board. It is a requirement on all federal funded projects to install

detectable warning surfaces as stipulated in the regulations. The Oregon Structural Specialty Code specifies requirements for detectable warning surface installation on private site development which at least meets minimum requirements under the ADA and may exceed requirements and incorporate national best practices. The Oregon Structural Specialty Code is updated more frequently, typically every few years.

Provide detectable warning surfaces on curb ramps to indicate to persons with varying abilities when they are approaching an area with operating vehicles, rail cars, or transit services. Detectable warning surfaces are generally placed at the bottom of curb ramps near the curb line at crosswalks including shared use paths, accessible route islands, and medians (See Criteria R1, Criteria R2, and Criteria R3). The detectable warning surface is a standard component of curb ramps but is also applied to other pedestrian walkways and surfaces at crosswalks such as pedestrian pads to access a pedestrian push button on rural roadways. The detectable warning surface replaces the other detectable feature of a raised curb, that has been replaced with a curb ramp to allow wheeled devices to continue along the walkway. The detectable warning surface provides information about the locations of the flush connection of the pedestrian access route and where attention is needed before proceeding.

Detectable warning surfaces are omitted from curb ramps that do not provide access to a crosswalk when the walkway ends (for example [RD950](#) end of walk curb ramps). They are generally not provided across driveways ([RD725 through RD750](#)) in the walkway unless it's signalized. **Where curbed radius driveway approaches are constructed, a curb ramp is provided to continue the pedestrian accessible route through the private drive and a detectable warning surface is required.**

Detectable warning surfaces are installed at transit areas to indicate bus and train service boarding and alighting areas. Provide detectable warning surfaces at all pedestrian railroad crossings and refer to Section 840 for additional railroad requirements (Criteria R3).

821.1.1 Temporary Pedestrian Access Routes

Temporary Pedestrian Access Routes are required in all construction work zones on or along the State Highway System, all federally funded projects, and all projects delivered by or contracted through ODOT. Temporary Pedestrian Access Routes are to be accessible and useable to pedestrians. Detectable warning surface placement is largely the same principle as permanent walkways. The color, material selection, installation and placement will be of limited duration so the product longevity is less critical however it must conform to the same standards. *Temporary curb ramps as shown in DET 4780 provide a detectable warning surface when the temporary curb ramp serves a crosswalk. A detectable warning surface treatment at the edge of the travel way at the temporary crosswalk may be required depending on the pre-existing site conditions.* Temporary pedestrian access routes may resemble protected pedestrian

lanes. Other means of transport through the work zone may be used in place of temporary pedestrian access routes.

821.1.2 General Design Considerations

The United States Access Board provides standards for detectable warning surface dimensions and placement of truncated domes. ODOT has specific standards for applications of a detectable warning surface on or along the state highway system. Other Oregon road authorities or jurisdictions may have their own standards that deviate from ODOT practice.

Color

Detectable warning surface color selection should be a high contrasting color to the adjacent surfaces that it is installed on. High contrasting colors are more easily detected by persons with vision impairments and other pedestrians who are distracted and perform better in low light and wet conditions.

Provide a safety yellow detectable warning surface on or along the state highway. Alternative colors must be approved with a Design Exception that is signed by the State Traffic Roadway Engineer when installed on or along the state highway, or that is included with any ODOT contract even when the curb ramp is on a local road or property. *Alternative colors are sometimes necessary to meet the location and unique characteristics of the installation and consultation with the Senior ADA Standards Engineer is required.* The most common alternative colors used for detectable warning surfaces are safety red, brick red, white and natural patina cast iron in historic areas.

Context and location of the construction improvements is necessary when considering alternative colors to the standard for detectable warning surfaces. Safety yellow's bright color is good at attracting the attention of the human eye and provides strong contrast with surrounding surfaces such as asphalt, concrete, and red brick.¹⁶ Safety yellow is also a color that signifies caution and is consistent with pedestrian safety signing and labeling standards.¹⁷

When evaluating alternative colors, the surrounding environment is assessed to ensure that the detectable warning surface color contrasts with adjacent features such as painted curbs and colored pavers, colored crosswalks, or walkways. *Multi-agency coordination of detectable warning surface color selection is required where there are historic or potentially eligible historic designations on properties, specific features, and corridors. This coordination requires*

¹⁶ FHWA, Color and Contrast of Detectable Warnings Technical Brief June 2007 (James Jenness & Jeremiah Singer)

¹⁷ ANSI Z535: Standard for Safety Signs and Labels, 2017

evaluation of visual impacts to those resources with the State Historic Preservation Office (SHPO).

Alternative detectable warning surface color considerations:

- Safety red is an alternative that performs well with asphalt and concrete and may be requested when safety yellow is not desired for aesthetic or other contextual reasons. Red typically signifies “stop” or “danger” when it comes to safety.
- Brick Red is softer in color saturation and is often requested in historic areas to reduce visual impact to protected historical buildings and features compared to safety yellow. Special attention and design mitigations must be taken when using brick red so that it contrasts with the sidewalk and road surfaces particularly in shaded, dark, or unlit areas, and near areas installed with hardscaping such as inlaid brick pavers or dark bark mulch.
- Safety Blue is sometimes used to identify accessible areas, and to provide information to pedestrians consistent with MUTCD recommendations for pavement markings and signing. **Safety Blue is the ODOT standard for detectable guide strips.**
- White may be considered for detectable warning surfaces placed on or near roads or paths made of dark-colored asphalt as high contrast, or in coordination with green bicycle lane markings or boxes. White may also be the best contrast choice when the walkway is comprised of red unit pavers or similar concrete coloring.
- Cast iron detectable warning surface may be used in locations with extreme temperatures and where snowplows are used to maintain the walkway or roadway. Colored coating can be specified but is easily damaged by snowplow equipment and abrasion. Natural patina cast iron will change to a rusty, orange-brown color over time.
- Black is discouraged as many people with low vision interpret darkness as holes in the surface or water ponding.

Detectable warning surfaces that are exposed to ultraviolet (UV) light may lose their color contrast over time and will require replacement because of sun fading. Replacement criteria for low conspicuity has not been determined at this time.

Material and Application

Detectable warning surface materials can be made of various materials and are not limited to polymers and cast iron. The most common is a rigid or semi-pliable plastic tile that is usually installed while the concrete is curing (wet set) and is bonded to the concrete with underlying webbing and/or anchors in the concrete. Edges are installed flush with the final grade of the walkway. Some products have replaceable tiles that can be removed and reinstalled when they become faded. Applications requiring adhesive or are bonded to the material to secure to the walkway are considered surface applied. All types of products for detectable warning surfaces need to ensure no lips are created in the walkway when installed. The tiles may be cut for

installation to follow a radius and must conform to the US Access Board's spacing requirements for adjacent truncated domes when they abut each other (see Figure 800).

Designers will need to specify the type of application for a given location. Considerations for product selection are important for longevity of the curb ramp system. Various products provide options including installation of a detectable warning surface on temporary pedestrian access routes, maintenance or upgrade of existing facilities, and new construction. There are different methods for securing detectable warning surfaces to the walkway depending on the material and manufacturer's design.

Wet Set (WS):

Wet set detectable warning surfaces have anchors attached to the bottom of the panel. The panel is then placed into wet concrete such that when it cures, the detectable warning surface is affixed to the concrete surface. These types of applications have a long service life and are generally maintenance free.

Wet Set Replaceable (WS Repl.):

Wet set replaceable products are installed similarly to a standard wet set product, but in this case the top truncated dome tiles can be unscrewed from the rest of the detectable warning surface anchoring plate. This allows for the detectable warning surface to be replaced when damaged or faded without disturbing the concrete. The replacement tile can be a different color than the original anchoring plate.

Wet Set Snow Zone (WS SZ):

The wet set snow zone category is used to capture items that are designed for snow zones exposed to plowing blades and wire brushes, or in areas of high elevation with frequent snow fall events, typically above 3000 feet. In most cases these detectable warning surface products are constructed from cast iron. These can have colored or clear coats, or are untreated so it leaves a natural patina over time as it weathers. Sizes of cast iron tiles are limited and may not fit a curved radius application that meets ODOT's installation requirements. Review the current ODOT qualified products list for approved tile sizes and configurations when designing; there may be some limitations that constrain your design layout in a snow zone.

Figure 800-52: Wet Set Polymer Detectable Warning Surface Tile Dome Spacing is Maintained

**Surface Applied (SA):**

The surface applied detectable warning surface tiles or mats utilize an adhesive to secure the product to the walkway. The walkway will need to be thoroughly cleaned to ensure a solid connection. Use manufacturer recommended adhesives and preparations. Caulking is typically required to prevent water from infiltrating underneath the tiles. These types of installations are more temperature sensitive both during and after construction. Surface applied applications are useful when a detectable warning surface needs to be installed on aged and cured concrete, or for temporary pedestrian access routes (TPAR) with curb ramps. Special care needs to be taken to avoid lips at the edges of the detectable warning surface.

Liquid Applied (Liquid Appld.):

This is a liquid product that is applied to a cured surface. A liquid applied detectable warning surface is made from a liquid resin mixture that can be applied to the walkway surface with paint rollers and a dome mat mold. This application method requires a certified installer. The walkway surface needs to be thoroughly cleaned and be free of debris to ensure a solid bond. This product is not typically intended to be subjected to vehicular traffic. It can be applied to asphalt, concrete, unit pavers and metal (such as vault lids, manhole covers, etc.). This type of installation is more temperature sensitive during construction, however, it can be used in a wide variety of locations to improve accessibility without disturbing the existing walkway. It is the only application presently ODOT approved for installation on asphalt walkway surfaces.

Installation and Placement

There are various geometric configurations for curb ramps. The placement of the detectable warning surface, with a few exceptions, is at the back of the curb line at the curb ramp opening. The purpose of the detectable warning surface is to inform and communicate to pedestrians when they are about to enter or exit the space where vehicles are operating (the Transition and Travelway Realm). As a pedestrian continues through the crosswalk, the detectable warning surface with high contrast informs people where the flush connection is to the walkway. While this aids primarily those with low vision, it benefits all pedestrians including those using wheeled mobility devices. Detectable warning surfaces are not required to be installed in a set of pairs at each end of the crosswalk. For example, there may only be a detectable warning surface installed on the curb ramp for a walkway on one side of the roadway where the other end of the crosswalk is an open shoulder with no detectable warning.

In pedestrian refuge islands the detectable warning surface provides the same function, and effectively communicates where vehicles are operating. **Provide at least 2 feet of separation between the detectable warning surfaces along the path of travel (curb ramp design exception Criteria R2) for accessible route islands.** When the length of the refuge is not at least 6 feet long from back of curb to back of curb, the detectable warning surfaces are omitted.

Install the detectable warning surface full width of the curb ramp opening, refer to Criteria R1. Provide a continuous section of detectable warning surface that is at least 2 feet deep in the direction of the pedestrian travel (curb ramp design exception (Criteria R1)). The minimum depth is based on the average pedestrian stride length to ensure there is foot contact when walking. Lesser depths have a high probability that a pedestrian will step over them and miss the warning device. *Depths of detectable warning surface that exceed 3 feet are discouraged.*

The placement location of the detectable warning surface is dependent on the curb ramp style and/or on the distance between the grade break to the back of curb (see applicable ODOT standard drawings in the RD900 series). The dome spacing orientation is not required to follow a pedestrian path of travel. It can be helpful if aligned with pedestrian travel, however, they do not provide any orientation cues for people using them in the United States. The truncated domes are an attention pattern.

Detectable warning surfaces are to be flush and have no lips between the edge of the tile and the surface it is applied to (curb ramp design exception Criteria T) when installed. Where there is no curb zone at the installation, the detectable warning surface is placed at the edge of the roadway before a pedestrian enters the marked or unmarked shoulder. A common example is an accessible route on a cut through island where the detectable warning surface is placed on the existing pavement and there is no curb. This also occurs at most shared use path connections to a roadway (Figure 800). The detectable warning surface is placed flush with the improved edge of the roadway or edge of the raised island in that circumstance.

Figure 800-53: Detectable warning surface with No Curb Zone (Source: Standard Dwg. RD904)

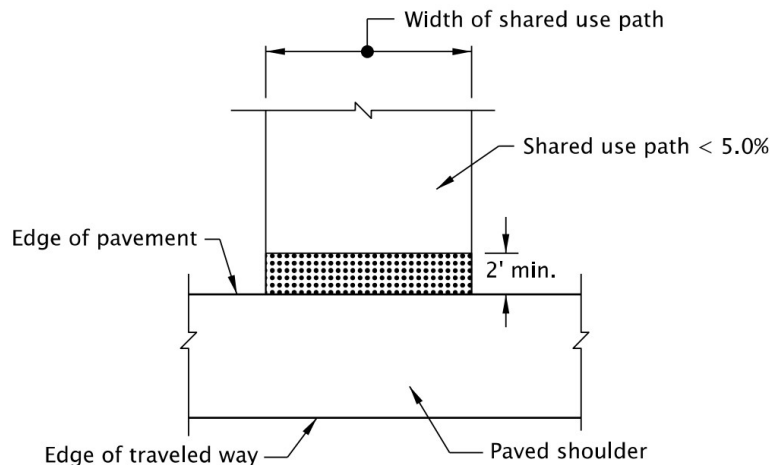

SHARED-USE PATH CONNECTION

For **Criteria R1, Criteria R2, and Criteria R3** detectable warning surface design exceptions, ensure placements are consistent with the standard drawings for detectable warning surfaces. This includes the maximum gap space on the outside edges of the tiles, on each side and along the back of curb. **The gap space cannot exceed two inches on all outer edges of the detectable warning surface at curb ramps (Criteria R1 or Criteria R3) at final construction.** Refer to Figure 800-54 and Figure 800 below. The maximum gap space allowed with monolithic curb and gutter is the same; it is typically 8 inches in total from face of curb with a standard curb top. Roundabouts use a different curb, typically a low-profile mountable curb, to define the edge of roadway. The monolithic construction distance and gap will be larger because the curb itself is 12 inches wide in that scenario. **Provide detectable warning surface installations at the back of curb when there is a curb zone. Refer to Detail “A” in the figure below and the Oregon Standard Drawings.** There are a few exceptions that are described in this section.

ODOT has various manufactured products on the Qualified Products List (QPL). Some supply radial dome sections and the detectable warning surface can be ordered with radius pieces that are customized for the site condition. Some products tiles will need to be cut and modified for installation to meet the requirements of detail “A”. The 2-inch gap space will be verified during curb ramp inspections.

Figure 800-54: Detectable warning surface at Curb Ramp

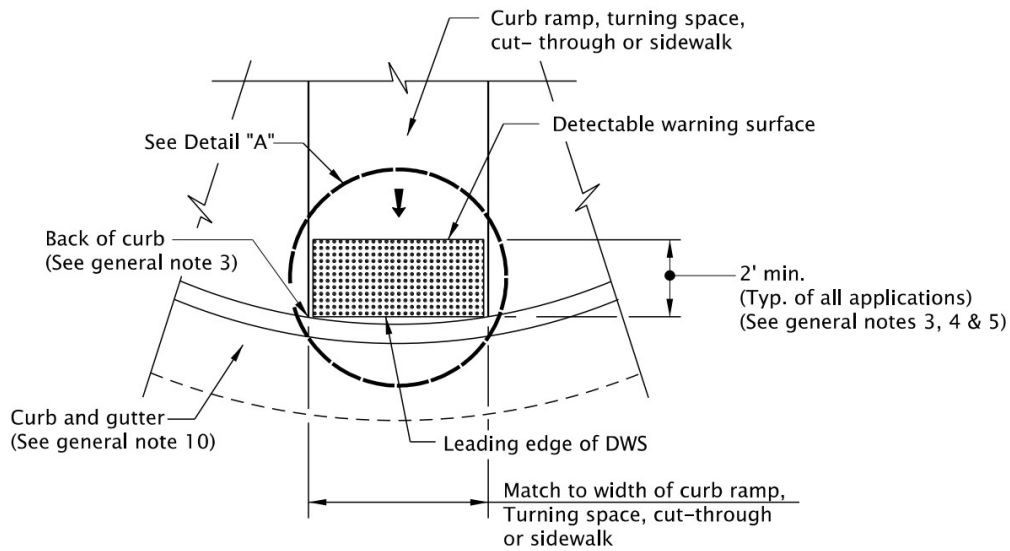

DETECTABLE WARNING SURFACE DETAIL

Figure 800-55: Detectable Warning Surface Maximum Gap Space Detail

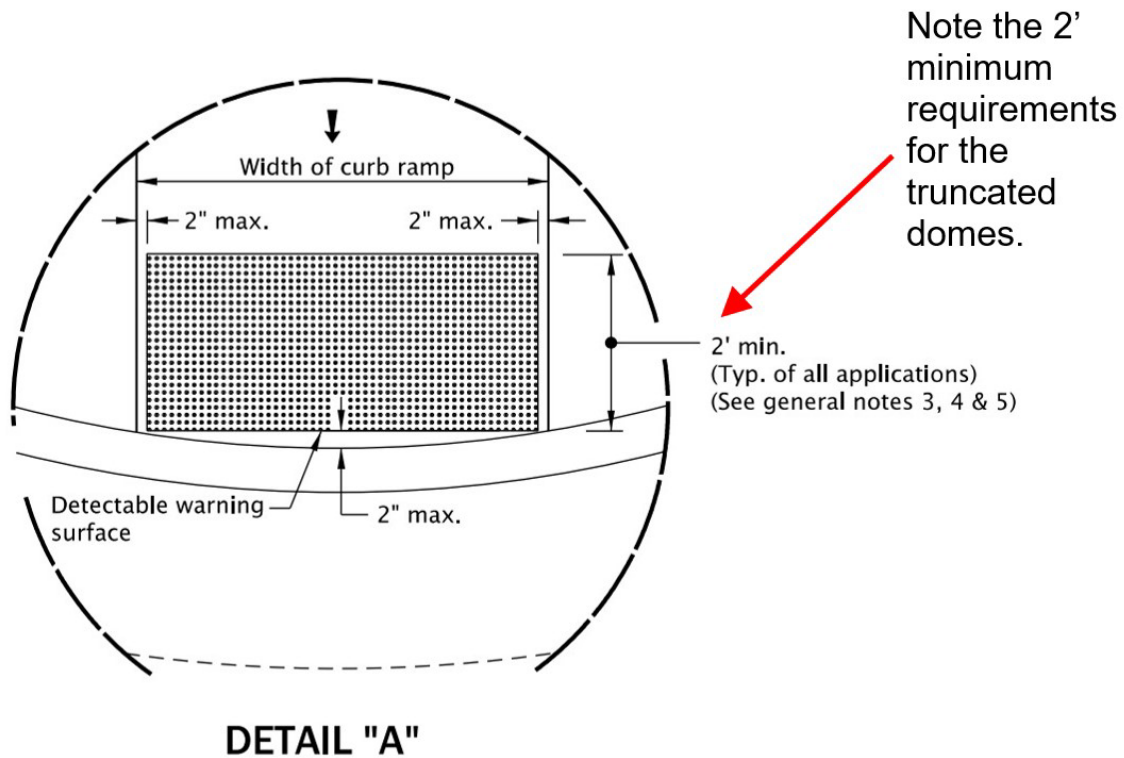

DETAIL "A"

Detail “A” calculations should be performed to check to see if it is physically impossible to meet the requirement for a 2 inch or less gap. A graphical check can be done in your CAD application, or it can be computed mathematically using the following formulas:

$$g=r\pm\sqrt{r^2-w^2}$$

Where:

w = ½ width of the curb ramp

r = radius of the curb

g = the gap between the detectable warning surface and the back of the curb

This formula will yield two answers, a longer length, and a shorter length. The shorter length is the gap. The sum of the two answers is the diameter of the circle or 2r.

$$r=\sqrt{g^2-w^2}/2g \quad \text{to find the radius with a specific gap and curb ramp width.}$$

$$w=\sqrt{2gr-g^2} \quad \text{to find the width with a specific gap and radius.}$$

ODOT standard radius is 20 feet on minor road approaches. Local street conditions are more likely to encounter small radius curbs.

The detectable warning surface is typically placed at the back of curb for a minimum depth of 2 feet. **The two feet must be completely filled with the truncated domes and maintain the required dome spacing dimensions.** Gaps in between abutting tiles are not permitted to exceed ¼ inch. Dome spacing can be maintained with some creative cutting of the tiles which minimizes the amount of product waste. In some cases, the individual truncated dome is ground to a flush surface on the edges to ensure a lip is not created in the walkway. Refer to Figure 800-56 and Figure 800-57 where detectable warning surface tiles are cut to fit a radius at the curb ramp where all spacing requirements for installation are met. Designers do not need to layout tile placement in contract plans in most scenarios unless a specific need arises.

Figure 800-56: Example 1, Detectable Warning Surface Rectangular Tile Cutting to Fit Radius



Figure 800-57: Example 2, Detectable Warning Surface Rectangular Tile Cutting to Fit Radius



821.1.3 Directional Curb Ramp Installation

To ensure that the ramp run(s) on the curb ramp system are perpendicular at the top and bottom of the ramp run (Criteria T), a directional curb may be required along the radius of the corner. The placement of the detectable warning surface is determined by the length of the directional curb from the lower grade break of the ramp run and whether the area is traversable by pedestrians.

When flares are constructed with a directional curb, the detectable warning surface is set at the back of the curb. The directional curb forces the lowest grade break position of the ramp run to be indented at least 2 feet to install wet set detectable warning products. The tiles are rigid and installing tiles over a grade break is difficult to achieve while maintaining all requirements of the accessible route. The category of product that can be installed over a grade break is liquid applied detectable warning surface.

Figure 800-58: Directional Curb with Flared Construction

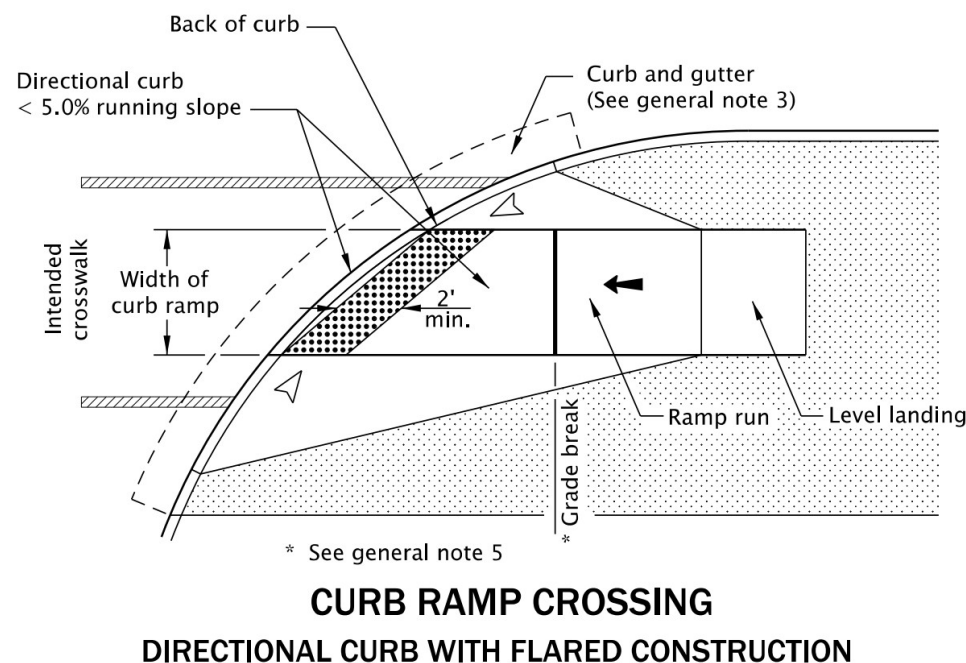

(Source: Standard Dwg. RD905)

When there is a buffer zone treatment that has a curb return constructed with a non-traversable surface, determine the longest length of the directional curb parallel to the running slope. When the longest length is less than or equal to 5.0 feet (verify both ends of the directional curb), the tiles are installed above the grade break on the bottom of ramp run. Pedestrians stopped at the detectable warning surface are generally understood to be signaling intent to use the crosswalk. Refer to the Figure 800 below.

Figure 800-59: Directional Curb with Grade Break Less than 5 Feet and No Flare

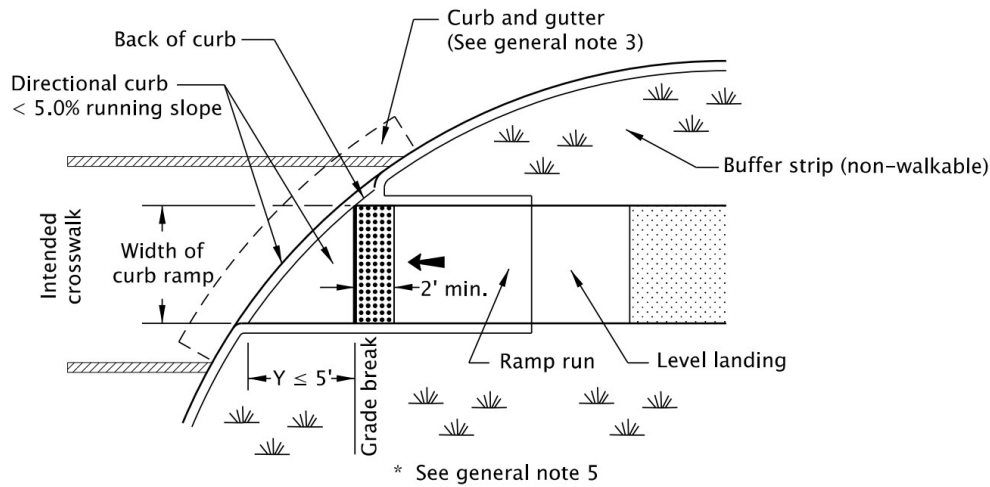

**CURB RAMP CROSSING
GRADE BREAK ≤ 5 FT. FROM BACK OF CURB**

(Source: Standard Dwg. RD905)

When one of side of a directional curb (verify both ends) is larger than 5.0 feet, detectable warning surfaces are placed along the back of curb where a pedestrian is more likely to be recognized and showing intent to use the crosswalk. See Figure 800 below.

Figure 800-60: Directional Curb with Grade Break Larger than 5 Feet and No Flare

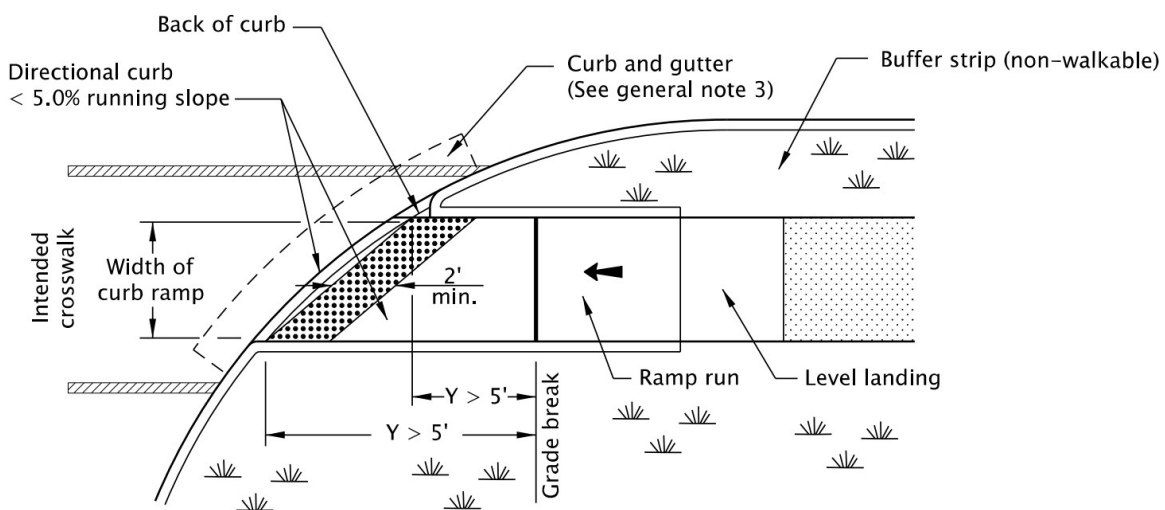

**CURB RAMP CROSSING
GRADE BREAK > 5 FT. FROM BACK OF CURB**

(Source: Standard Drawing RD905)

Figure 800-61: Directional Curb with Grade Break Less than 5 feet and No Flare Photo



821.1.4 Driveway Installations

Private driveways located between public street intersections are not required to provide pedestrian crossings across the highway. However, if the private driveway has a walkway on either side, then it must have an ADA accessible path across the driveway. There are three general types of driveways in urbanized areas: dustpan, lowered dustpan, and driveways with curb radii. Refer to Figure 800 through Figure 800-65 for detectable warning surface installation requirements at driveways.

For unsignalized driveways with curbed radii at the approach, install detectable warning surfaces at the approach with a curb ramp (see Figure 800-63), Criteria R3. Review Part 500, Section 505 to determine which driveway design treatment is appropriate for the approach volume. **When a private driveway is signalized, treat it as a public intersection with a crosswalk and provide detectable warning surfaces as required (see Figure 800 through Figure 800-65).** Signalization allows vehicles to operate free flow across the driveway on a green indicator, and pedestrians are to be warned they are entering the roadway realm. Signalized protected bike lanes, need to be reviewed for pedestrian right of way and operation to determine if detectable warning surfaces are needed for that live lane of traffic. *Consultation with the Senior ADA Standards Engineer and State Bicycle & Pedestrian Design Engineer is required.*

Figure 800-62: No Detectable Warning at Dustpan and Lowered Driveways

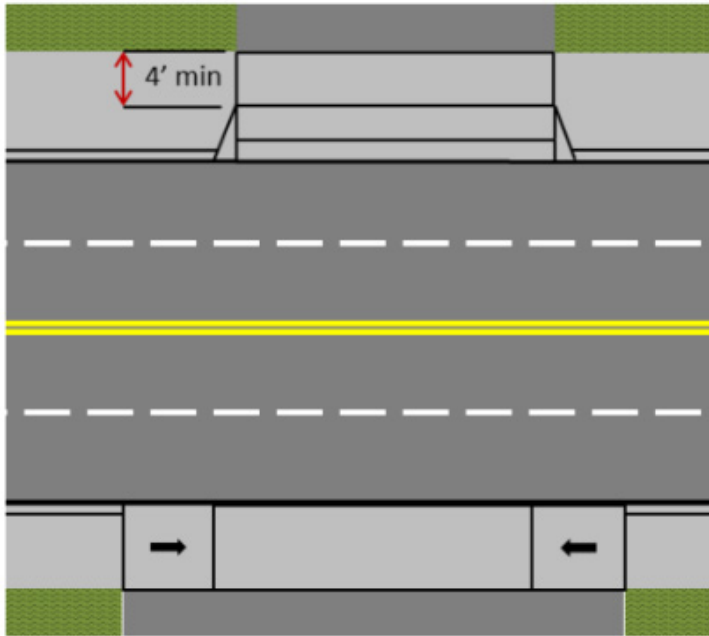

Figure 800-63: Detectable Warning Surface at Curb Radii Driveway

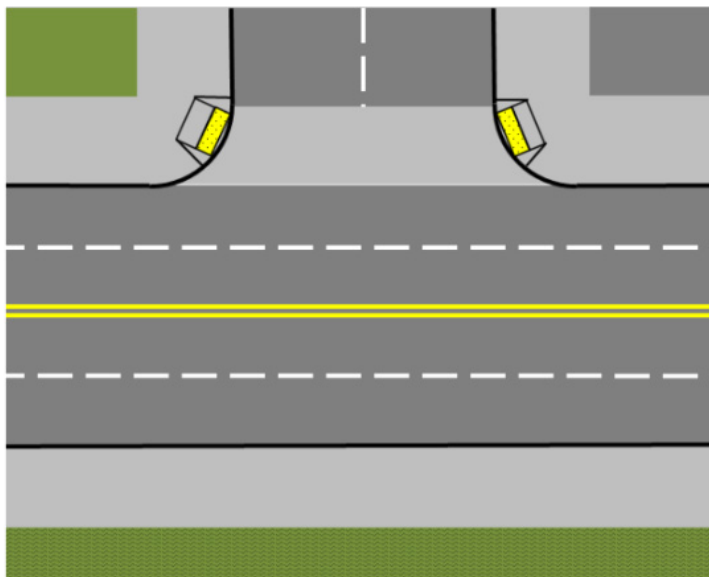

Figure 800-64: Signalized Driveway Example 1

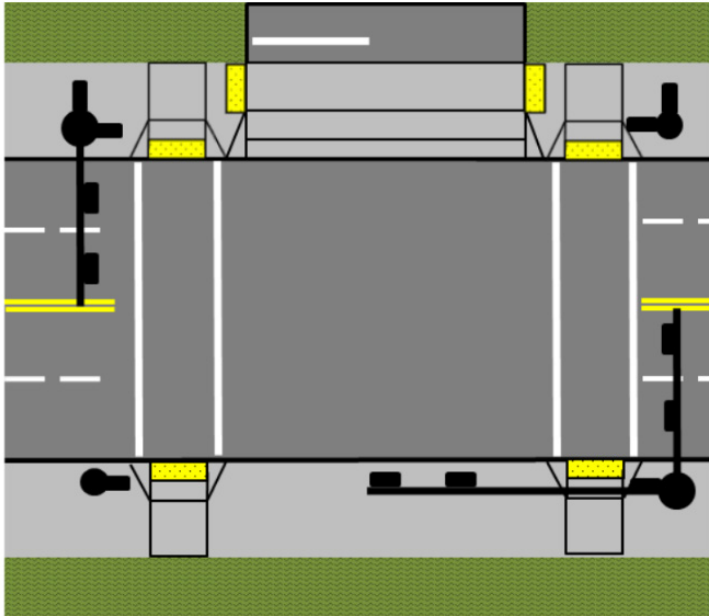
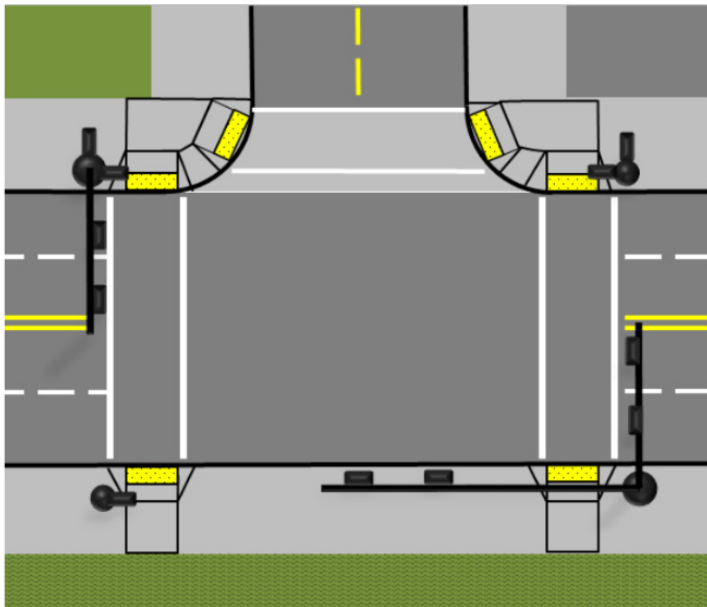

Figure 800-65: Signalized Driveway Example 2



821.1.5 Raised Crosswalks, Truck Aprons, Protected Bike Lanes, Pedestrian Lanes, and Pedestrian Pads

Detectable warning surfaces are to be placed where the pedestrian encounters the boundary of the vehicular way (Criteria R3) for raised crosswalks, truck aprons, protected bike lane, pedestrian lanes, and pedestrian pads. *Consultation with the Senior ADA Standards Engineer is required for scenarios that are not illustrated in the Oregon Standard Drawings for the appropriate detectable warning surface design.*

Review the Oregon drawings in the RD 900s for additional details on detectable warning surface placement. Refer to Section 810.7.4 for pedestrian lane placement example in the figure, where vehicle off tracking analysis should be performed to determine the best location for installation of the detectable warning surface. Pedestrian pads are another area typically designed for accessible pedestrian push button access. When the pedestrian pad lies outside of the normal roadway shoulder, detectable warning surfaces are installed to denote the boundary of the operating roadway.

Detectable warning placement for separated bike lanes is illustrated on RD1140 when there is a pedestrian refuge area/ buffer strip provided. When bike lane facilities are designed at the same elevation of the pedestrian access route walkway, there is not a clear means of providing mode separation. A bike curb is one alternative to create a small grade separation between the two travel modes to discourage intermingling of bicyclists and pedestrians as shown on RD1140, refer to Section 900 for more guidance on protected bike lane design. *Consultation in these scenarios with both the Senior ADA Standards Engineer and State Bicycle and Pedestrian Design Engineer is required as best practices are still evolving to ensure the system is useable for all pedestrians with various disabilities.*

Figure 800-66: Raised Crossing, Truck Apron or Protected Bike Facility

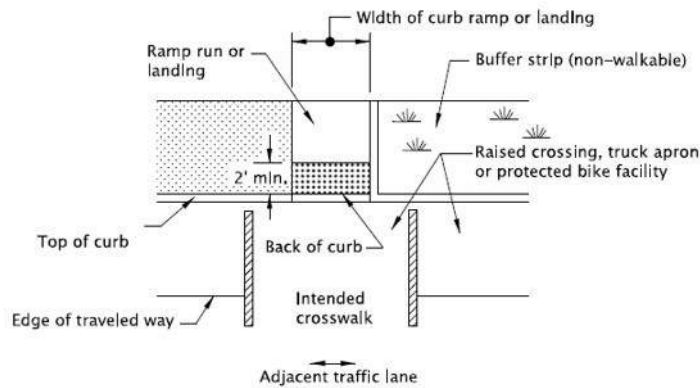

**RAISED CROSSING, TRUCK APRON
OR PROTECTED BIKE FACILITY**

Source: Standard Drawing RD904

821.1.6 Transit Installations

Reserved for future content.

821.1.7 Rail Crossing Installations

Detectable warning surfaces are placed in advance of the sidewalk and rail track interface to alert pedestrians with vision impairments of the presence of the rail crossing. Criteria R3, on the ADA Curb Ramp Design Checklist (Form 734-5184) discusses detectable warning placement based on the type of rail operation service. Refer to Section 840 for detectable warning placement at rail crossings that follow Oregon drawing RD908. Rail crossing designs will require coordination for approval of the Rail Crossing Order reviewed by the ODOT Commerce and Compliance Division, which will depict the detectable warning surface location for installation along with other pedestrian treatments. *When the railway is very close to the highway travel way or may involve signalized pedestrian crossing of the railway, early coordination with the Senior ADA Standards Engineer is required to discuss appropriate treatments of detectable warning surfaces and design exceptions.*

821.2 Detectable Guide Strips

Detectable guide strip placement is based on emerging best practices in the United States for tactile walking surface indicators used primarily for low vision and blind traveling pedestrians. Placing the detectable guide strip with the correct orientation of the bars or lines of the linear feature is important as this pattern provides different information from the attention pattern of the truncated dome. **Ensure the system is accessible and useable at roundabouts by installing a blue detectable guide strip near the bike ramp to effectively locate the pedestrian crosswalk and to guide pedestrians along the intended walkway.**

Truncated dome detectable warning surfaces are not to be installed in lieu of the detectable guide strip. Existing truncated dome detectable warning surfaces may remain in place at bike ramps at a roundabout if it is designed like a bike lane drop; *however, the detectable guide strip should be added when a construction or maintenance project is in the vicinity of the intersection of the roundabout.* The truncated dome panel at a bike lane drop provides a secondary message to pedestrians if the detectable guide strip is not initially understood or missed. Truncated dome detectable warning surfaces installed in the parallel or angled ramp approach will need to be removed and replaced with a detectable guide strip. In these cases, it is not intended to be a crosswalk entrance or exit curb ramp and the detectable warning surface give a mixed and unintended message. **Review Oregon drawing RD909 for placement location of the detectable guide strip when the ramp serves only bicyclists.** Refer to Section 845 for shared use paths at roundabouts. **When the constructed curb ramp serves both pedestrians and bicyclists, refer to Oregon Standard Drawing RD902 and install the truncated dome detectable warning surface.**

Section 830 Crosswalks and Crossings

Sidewalks provide mobility along the highway for transportation, but full pedestrian accommodation also requires frequent and convenient crossing opportunities. Wide highways carrying large traffic volumes can be barriers to pedestrians, making facilities on the other side difficult to access. Crossing opportunities are not limited to marked crosswalks and signals; many other design elements can enhance the pedestrian's ability to cross a highway.

Most pedestrian crashes occur when a pedestrian crosses a road, often at locations other than controlled intersections. Mid-block and uncontrolled intersection crossings need to be considered, as people will take the shortest route to their destination. Prohibiting such movements is counter-productive if pedestrians cross the road with no protection. It is better to design highways that enable pedestrians to cross safely.

Developed, urban state highways should provide convenient pedestrian crossing opportunities. The range of Target Spacing for pedestrian crossings ranges from 250 feet to 1500 feet based on

the Urban Context. Target Spacing of pedestrian crossings is in Section 310 of the Traffic Manual. Crossing improvements should be no closer than 300 feet from the nearest signalized crosswalk. Planning documents may also help identify potential locations for crossings. Note that crossing locations must consider property access and circulation. A full discussion on how the spacing targets were developed is available in Volume 2 of ODOT's Blueprint for Urban Design.

Safe and convenient pedestrian crossings cannot be considered in isolation from the following issues, which should be addressed when seeking solutions to specific problems. Appendix L, the Oregon Bicycle and Pedestrian Design Guide describes each of the following issues in detail.

- Volume to Capacity (V/C) and Design Standards ([Appendix L](#), page 5-3)
- Land Use ([Appendix L](#), page 5-4)
- Transit Stops ([Appendix L](#), page 5-4)
- Signal Spacing ([Appendix L](#), page 5-4)
- Access Management ([Appendix L](#), page 5-5)
- Out-of-Direction Travel ([Appendix L](#), page 5-6)
- Midblock versus Intersection Crossings ([Appendix L](#), page 5-6)
- Maintenance ([Appendix L](#), page 5-7)

No one solution is applicable in all situations as the issues will vary on any given section of highway. In most cases, it is best to combine measures to improve pedestrian crossing opportunities and safety. Note that some crossing treatments and curb extensions can trigger freight mobility concerns described in Freight Mobility Policy, Appendix C, in relation to ORS 366.215 regarding a reduction in vehicle carrying capacity.

830.1 Raised Median Design and Crossing Islands

Raised medians are a solution in locations where pedestrian crossings are not isolated to a single location and crosswalks are not marked. Raised medians benefit pedestrians on two-way, multi-lane streets, as they allow pedestrians to cross only one direction of uncontrolled traffic at a time. Raised medians should be constructed so they provide a pedestrian refuge by ensuring that they have a smooth level accessible surface and pedestrian access routes through them. On landscaped medians, plants should be low height, so they do not obstruct visibility, and are spaced far enough apart to allow passage by pedestrians. Flat, paved areas can be provided approximately every 50 feet to provide a place to stand and wait.

Figure 800-67: Continuous Raised Median versus Cut-Through Crossing Island

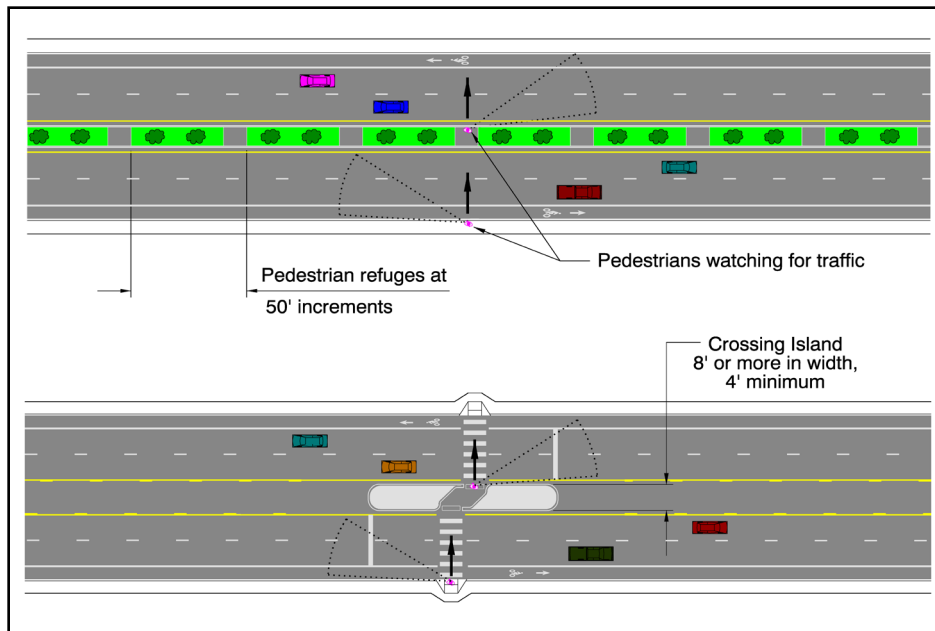

Where it is not possible to provide a continuous raised median, crossing islands can be created between controlled intersections. These should be located across from high pedestrian generators such as schools, park entrances, senior and disabled residential facilities, libraries, parking lots, etc. An island can also be provided in the middle of an intersection. An island should be at least 4.0 feet wide, preferably more, especially if bicycles are accommodated and to be considered useable by pedestrians. See Part 800Section 835 for bicycle crossing accommodation. **Install truncated domes in the cut through if the cut through length can provide at least 2 feet of separation between detectable warning surface panels consisting of truncated domes, this corresponds to Criteria R2 on the ADA Curb Ramp Design Checklist (Form 734-5184).** *The cut-through area may be angled up to 45 degrees to position pedestrians to face oncoming traffic for a portion of the crossing. The curb line is aligned parallel with the intended crosswalk at the entry and exit points to provide orientation cues for low vision and blind pedestrians, and this treatment removes potential tripping concerns.*

Figure 800-68: Angled Median Cut-Through Crossing

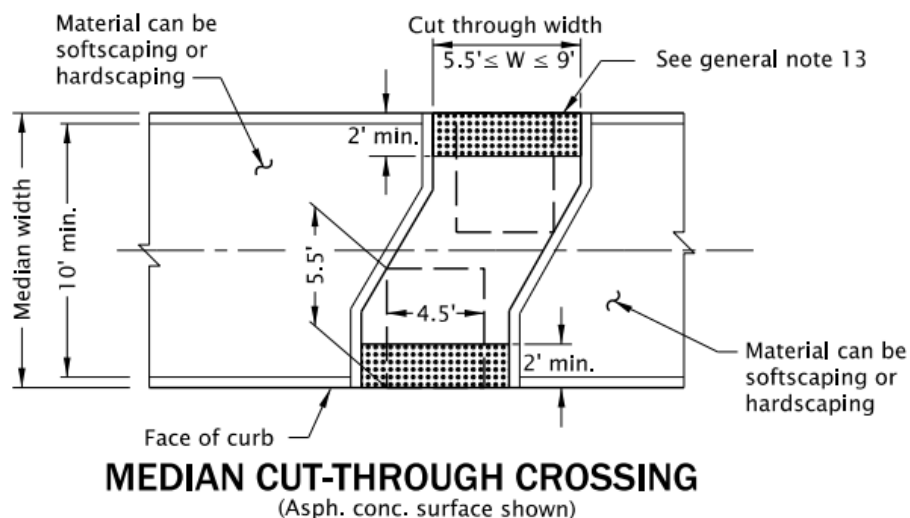

The length of an island should be at least 6-feet parallel to the traveled way. It is preferable to extend 30 feet to the advance stop bar. Islands must be large enough to provide refuge for several pedestrians waiting at once. For wheelchair accessibility, it is preferable to provide at-grade connections rather than perpendicular curb ramps. Poles should be mounted away from curb ramps and out of the pedestrian path.

Two stage crossings must be designed wide enough so that users are out of the traveled way. It must accommodate mobility devices which can be up to 60 inches long and provide detectable warning surfaces (DWS) for low vision users (See RD700's). *A fully accessible two stage crossing pedestrian refuge with curbing is typically at least 7.5 feet wide including the curb and construction margins for DWS panel construction.* Narrower widths of 6.5 feet can meet the ADA needs if the island design is surface mounted into the roadway (allowing 3 inches for construction errors on each side of the DWS). See DET 1771 for typical midblock RRFB construction requirements and configuration.

At wide intersections, there is often a triangular area between the through lanes and right turn lane that is not used by motor vehicle traffic. Placing a raised island in this area benefits pedestrians by:

- Allowing pedestrians to cross fewer lanes at a time, and to judge conflicts separately;
- Providing a refuge so that slower pedestrians can wait for a break in the traffic stream;
- Reduces the crossing distances (which provides signal timing benefits) providing an opportunity to place easily accessible pedestrian push-buttons.
- Simplifying signalization where the right turn lane can be left un-signalized.

830.2 Curb Extensions

Curb extensions are used in conjunction with on-street parking or wide shoulders. Mid-block curb extensions may be considered where pedestrians frequently cross between midblock generators on both sides of the road. Where parking is not marked in the shoulder, curb extensions enforce the ORS 811.550(17) restrictions which prohibit parked vehicles 20 feet from the crosswalk line.

Curb extensions provide many benefits to the pedestrian and use of the public right of way. Curb extensions can also provide a traffic calming effect, enhance the visual character of the community, and provide increased pedestrian circulation area at the crosswalk. Specific design considerations for the curb extension include street sweeping operations, snow removal operations, large truck off tracking and capturing storm water with drainage design. Curb extensions reduce the pedestrian exposed crossing distance by extending the walkway into the Transition Realm. Curb extensions improve the visibility of pedestrians for motorists. They provide a place for pedestrians to congregate while waiting to cross the street when the pedestrian volumes are large. Curb extensions increases the space available to provide a curb ramp and meet the ADA geometric requirements. Refer to Section 815 and Section 506 for more guidance of curb extension design.

Figure 800-69: Sight Lines with Curb Extensions

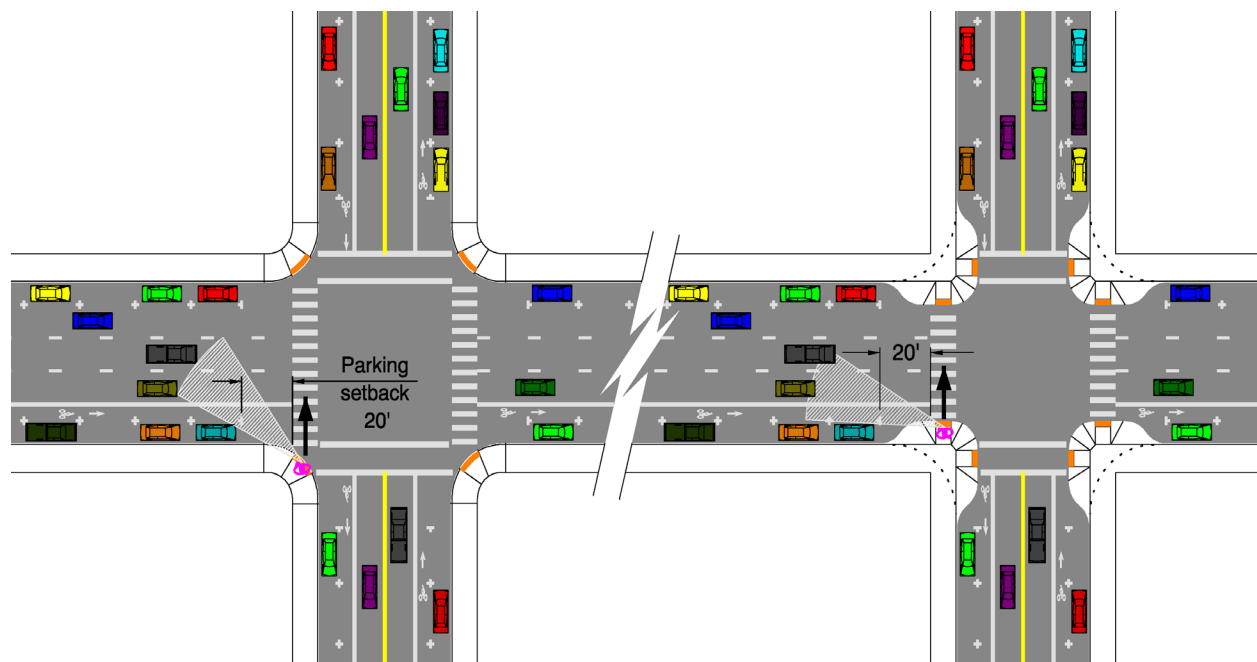

When curb extensions aren't viable due to the need to accommodate larger semi-trucks, a truck apron has a similar effect for delineating passenger car travel paths. See Section 830.3 on truck apron design.

Curb extensions can improve signal head alignment and stop sign placement. Reducing pedestrian crossing distance improves signal timing if the pedestrian phase controls the minimum green time for the corresponding signal phase. The time saved is substantial when two corners can be treated with curb extensions. Non-signalized intersections also benefit from curb extensions by reducing the time pedestrians are in a crosswalk which improves pedestrian safety and vehicle movement.

830.3 Truck Aprons

Truck aprons are designed for occasional large semi-truck to traverse when negotiating an intersection corner. Right turns are typically where large vehicles off track when the radius is not sufficiently sized, see Section 502 on accommodations of truck turning. Truck aprons delineate the passenger car vehicular travel path most effectively when the truck apron has a slight slope, low profile mountable curbing and contrasting pavement markings to discourage use. The pedestrian access route slope requirements must be maintained for the crosswalk including the truck apron (See RD100's). **Detectable warning surfaces are installed where the pedestrian enters the traveled way at the crosswalk at the edge of the sidewalk (See RD900s).** Truck aprons are not a place for pedestrians to wait to cross the street. See discussion in Section 800 on blended transition curb ramp configurations.

830.4 Marked Crosswalks

All legs of signalized intersections should have a marked crosswalk. Crosswalks may also be considered at other locations. Combined with curb extensions, illumination, and signage, marked crosswalks can improve the visibility of pedestrian crossings. Crosswalks send the message to motorists that they are encroaching on a pedestrian area. A traffic study will determine if a marked crosswalk enhances pedestrian safety. This is usually in locations that are likely to receive high use, based on adjacent land use. Refer to the ODOT Traffic Manual for further details on marking crosswalks and required approvals.

Marked crosswalks are typically 10 feet wide, or the width of the approaching walkway if it is greater. Consider high visibility crosswalks to increase their effectiveness. Textured crossings, using non-slip bricks or pavers, are generally not recommended. They give the initial impression that the visibility of the crosswalk is enhanced, but after time they fade and are barely distinguishable from the roadway surface. The inherent roughness also makes them

difficult for wheelchair users, and often does not meet the pedestrian access route surface requirements.

830.5 Enhanced Crosswalks and Crossings

For a thorough and detailed discussion on intersection design, see Part 500. The following discussion will help the designer understand some of the key intersection design features that help enhance the safety and convenience of pedestrians and bicyclists. Most conflicts between roadway users occur at intersections, where one group of travelers crosses the path of others. Good intersection design clearly identifies right of way of operations between motorists, pedestrians, and bicyclists.

At signalized intersections, pedestrian signal heads should be clearly visible - this requires that they not be placed too far from the nearest safe refuge. Crossing islands and curb extensions should be used to decrease crossing distances. Bicycle lanes should not be placed to the right of a right-turn only lane or to the left of a left-turn only lane, unless conflicting movements are controlled by a traffic control signal. Other intersection design principles for pedestrians and bicyclists are discussed in detail in Part 200, Section 224.1 and in Appendix L, the Oregon Bicycle and Pedestrian Design Guide, pages 6-1 and 6-5.

Conflicts between motor vehicles, pedestrians and bicyclists often occur at interchange areas. Free-flow ramps should be avoided. Where they exist, "Turning Vehicles Yield to Peds" symbol sign may be considered for unprotected pedestrian crossings. Consider grade separation when there is either two-lane right or left turn lanes or where free flow ramps are utilized. Other interchange design principles for pedestrians and bicyclists are discussed in detail in Appendix L, the Oregon Bicycle and Pedestrian Design Guide, pages 6-20 to 6-25.

830.5.1 Illumination

Providing adequate illumination is essential to increase nighttime safety, especially at mid-block or uncontrolled crossings which are often not expected by motorists. Guidance for illumination at pedestrian crossings is given in Appendix L, the Oregon Bicycle and Pedestrian Design Guide (pages 5-12 to 5-13), the [ODOT Traffic Manual](#) (Section 310.3), the [ODOT Traffic Lighting Design Manual](#), the IESNA Lighting Handbook (Tables 2 and 3), and the Federal Highway Administration report FHWA-HRT-08-053.

830.5.2 Signing

Review the Traffic Manual and MUTCD for advance warning recommendations. Signs might include advance warning signs, pedestrian crossing signs at the crossing itself, or regulatory signs at intersections to reinforce the message that motorists must yield to pedestrians. Excessive signage leads to signs being missed or ignored by drivers. These signs should only be placed at warranted locations.

830.5.3 Pedestrian Signals, Rectangular Rapid Flashing Beacons, and Hybrid Beacons

A pedestrian activated signal may be warranted where a significant number of people are expected to cross a roadway at a particular location. Anticipated use must be high enough for motorists to get used to stopping frequently for a red light (a light that is rarely activated may be ignored when in use). Additionally, sight-distance must be adequate to ensure that motorists will see the light in time to stop. Warning signs should be installed on the approaching roadway.

Refer to the Manual on Uniform Traffic Control Devices (MUTCD) for pedestrian signal warrants. Pedestrian signals may be combined with curb extensions, raised medians and refuges.

Crosswalks alone do not reliably warn drivers to stop for pedestrians on high speed or high volume multilane highways. Pedestrian-activated flashing beacons warn drivers that pedestrians are intending to cross. Examples of pedestrian activated crosswalk beacons include Pedestrian Hybrid Beacons, Rectangular Rapid Flashing Beacons and circular amber flashing beacons. Pedestrian activated crosswalk beacons may be combined with curb extensions, raised medians and refuges. Refer to the ODOT Traffic Manual, Section 310.3 for further details.

Pedestrian activation of a pedestrian traffic control device is required to be accessible to all pedestrians. Pedestrian pushbuttons are a service that activates the traffic control device for pedestrian use. The space to activate the push button is required to be clear and free of obstructions, level, free of lips, and of adequate size to approach the push button. The hardware installation of the push button must also meet the operable parts requirements under the ADA. Refer to the Traffic Signal Design Manual and the ADA Curb Ramp Design Checklist (ODOT Form No. 734-5184).

Section 835 Bicycle Crossings

Drivers are required to stop for pedestrians in crosswalks but are not necessarily required to stop for bicyclists. Bicyclists can use crosswalks to cross the street at pedestrian speed.

However, most bicyclists ride within crosswalks. Where bicycles are prevalent, such as bicycle boulevards, crossing islands can be designed to serve bicyclists and pedestrians separately at the crosswalk. If the crossing island acts as a diverter to through motor vehicle traffic, include a separate opening in the crossing island 6 feet to 8 feet clear width for the bicycle movements to match the bicycle lane dimension. Or consider two openings, each with 5.5 feet clear width for each direction of travel or mode of travel. The cut-through area may be angled up to 45 degrees to position bicyclists to face oncoming traffic. The desirable island clear width is 10 feet or greater to accommodate bicycles with trailers or groups of bicycles, or for shared use paths. The minimum length to accommodate a single bicycle is 6-feet.

See additional discussion for bicycle design in Part 900. Protected bike lanes add complexity to both the pedestrian design of the crosswalk and bicycle facility to ensure both modes use the facility as intended.

Section 840 Pedestrian Rail Crossings

The Federal Rail Administration categorizes pedestrian crossings as either a “pathway” or “station”. Practitioners should refer to the MUTCD for pedestrian railroad crossing treatments and provisions in the FHWA Highway-Rail Crossing Handbook, 3rd Edition for further guidance. Review the Federal Railroad Administrations “Engineering Design for Pedestrian Safety at Highway-Rail Grade Crossings” published report July 2016. All rail crossing improvements or alterations are reviewed by the ODOT Commerce and Compliance Division for approval of a Rail Crossing Order. Coordination is required with the Traffic Section for signalized rail crossings. Review the Railroad Diagnostic Meeting site notes for improvements and actions required for the project.

Railroad crossings include conventional rail cars used for transporting goods and freight. Operating speeds may vary from 40 mph to 80 mph. Light rail vehicles are commonly known as light rail, streetcars, or trolleys and travel at low speeds, 25 mph to 35 mph typically. Streetcars operate in the travel lane used by vehicles in the travel way realm. High-Speed or Rapid Rail trains generally reach traveling speeds of 150 mph to 220 mph.

840.1 Geometric Controls

Walkways crossing a rail track are not typically controlled by the automated warning gates/arms. **Provide a walkway width across the rail tracks at least as wide as the approaching walkway. Pedestrian movements should be designed so pedestrians do not wait between a set of tracks where multiple set of rail tracks are installed at a pedestrian railroad crossing.**¹⁸ **At rail crossings equipped with automatic protective devices, the traffic control device support shall be at least 5 feet from the nearest walkway edge to the centerline of the rail signal mast.**¹⁹ This separation ensures the counter ballast is not in the pedestrian path of travel obstructing the walkway and prevents rail equipment from becoming a protruding object in the walkway.

Provide a walkway horizontal alignment that is as close to a right angle or 90 degrees to the extent practical at the pedestrian rail crossing. When a walkway crosses rail tracks at a skew, people in wheelchairs are usually able to align themselves at a right angle within the width of a 6-foot sidewalk. Some people prefer to cross at a slight angle, so both caster wheels don't hit the tracks at the same time. Curving the entire sidewalk as shown below to cross tracks at 90° is usually unnecessary.

Figure 800-70: Skewed Walkway and Rail Track Crossing



The vertical clearance of a traffic control device over the walkway shall be at least 8 feet above the finished surface of the walkway.²⁰ When the rail crossing is a shared use path, the

¹⁸ MUTCD Section 8C.13

¹⁹ OAR 741-120-0025

²⁰ MUTCD Section 8D.03

vertical clearance shall be at least 10 feet. *The vertical profile of the pedestrian rail crossing should remain a constant grade for at least 12 feet beyond the outer most rail of the pedestrian rail crossing. The same vertical grade should extend to include the detectable warning surface or stop line when provided.* **Flange way gaps in rail at-grade crossings may not exceed 2-1/2-inches wide in the direction of pedestrian travel on light rail vehicle tracks (non-freight) and may not exceed 3-inches wide in the direction of pedestrian travel on railroad tracks (freight) for accessibility.**

Detectable warning surfaces are placed in advance of the sidewalk and rail track interface to alert pedestrians with vision impairments of the presence of the rail crossing. **Criteria R3**, on the ADA Curb Ramp Design Checklist (Form 734-5184) discusses detectable warning placement based on the type of rail operation service. **Place detectable warning surfaces at rail crossings either:**

1. **In between the range of 12-feet plus 8-inches to 15 feet from the nearest rail track for heavy (freight) rail, or.**
2. **At least 6-feet from the nearest rail track for light rail.**

Detectable warning surfaces should be placed immediately in advance of the marked walkway stop line if present. Where the distance between the centerline of two tracks exceeds 38 feet, additional detectable warning surfaces, designating the limits of a pedestrian refuge in between the set of tracks should be installed. **Detectable warning surfaces are installed full width of the walkway.** Refer to the RD900's for additional details. Striped markings may be used to delineate the dynamic envelope of railway at pedestrian crosswalks. Consult the Senior ADA Standards Engineer and Traffic Section for approval when the project is looking to incorporate marked indicators at rail crossings.

Active rail devices should be considered at pedestrian rail crossings with:

- high pedestrian volumes,
- high speed trains,
- extremely wide pedestrian walkways,
- complex highway-rail crossing geometry,
- locations in school zones,
- inadequate sight distance of the pedestrian at the rail crossing,
- multiple set of rail tracks that need to be crossed.

When provided, automatic pedestrian gates shall be a placed between 2.5 feet and 4 feet maximum above the walkway surface. However, the height will remain the same as prescribed for the cars when the vehicle crossing arm also crosses the walkway. The width of the automatic pedestrian gate shall provide coverage for the full width of the walkway. When

automatic pedestrian gates are installed across a walkway for a rail crossing, an emergency egress route should be designed to leave the rail track area.

Pedestrian rail crossing should be channelized with detectable pedestrian railing to designated pedestrian rail crossing locations that have been engineered at commuter rail and transit areas. Pedestrian fencing should not exceed 3.5 feet in height when used for pedestrian channelization to retain sight lines and not obscure a pedestrian. Pedestrian barriers/fencing in a maze type configuration may improve pedestrian safety by forcing pedestrians to look at rail traffic before proceeding to cross the rail tracks.

Section 845 Shared Use Paths

Shared use paths serve two purposes; one is providing a basic transportation need to get to destinations and the second is providing a place for recreational activity. When the pathway serves both pedestrians and bicyclists together, it is a shared use path. When pedestrians and bicyclists share a sidewalk, appropriate shared path guidelines are employed for the design. Shared use paths are designed to be fully accessible for all users for the entire width of the pathway. Combinations of the words “shared use” and “multi use,” are used interchangeably. Refer to Part 900 for additional design guidance on Shared Use Paths.

Figure 800-71: Shared Use Path



Paths accommodate many users

845.1 Shared Use Path Configurations

Shared use paths can parallel the state highway or may diverge on a separate alignment from the mainline onto other public right of way. Multi-use trails may include accommodation of additional users, such as equestrians. Sections 961 through 968 have design information that apply to all types of shared use paths. Shared use paths may be constructed on ODOT facilities that are separated from the roadway. See Figure 800-72 below for typical examples of shared use paths that may be constructed along a highway or roadway.

Figure 800-72: Types of Shared Use Paths

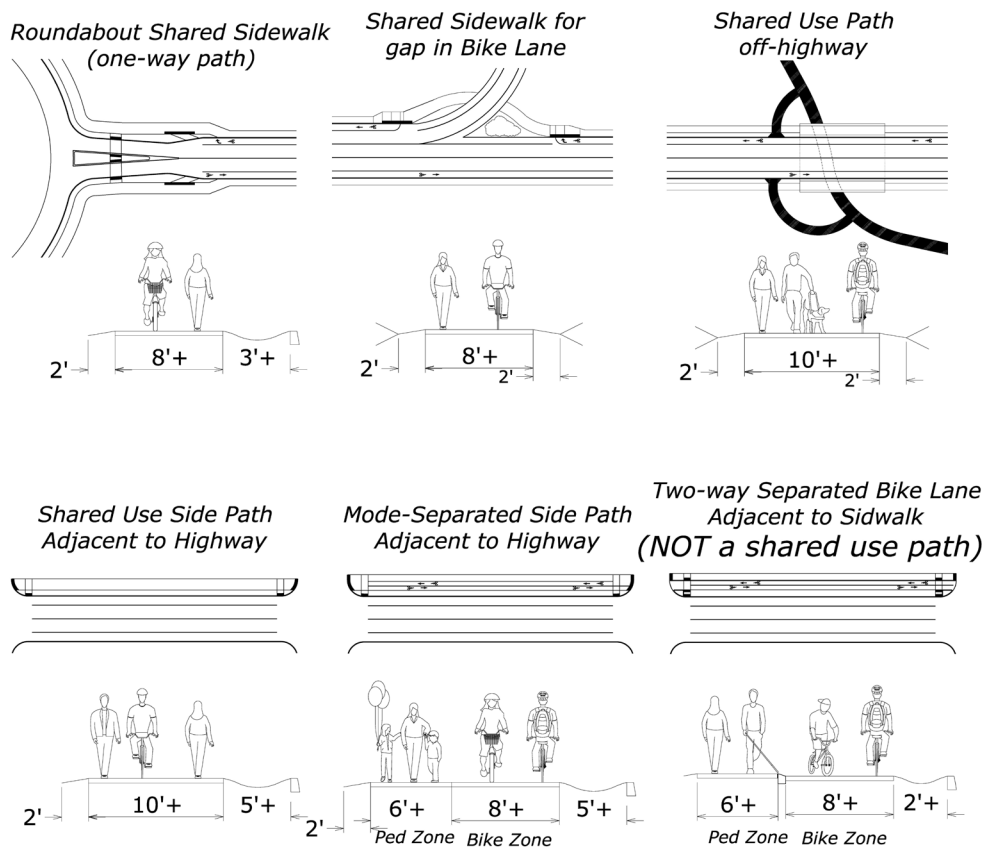

One type of shared use path includes facilities within the highway right of way where pedestrians and bicyclists are physically separated from the travel way realm. **A buffer zone with a physical separation of at least 5 feet from the travel realm is required for a shared use path.** Where a path is parallel and adjacent to a roadway, see Section 970. Where a bicycle lane joins a sidewalk, see Sections 971 and 981.

Well planned and designed shared use paths can provide access and mobility to pedestrians and bicyclists in areas where the roads do not serve their needs. A shared use path may have an

independent alignment on or off the public right of way. Shared use paths can have their own alignment along streams, canals, utility corridors, abandoned or active railroads, and greenways. Many shared use paths serve as linear parks for people. Shared use paths can serve both utilitarian and recreational cyclists. See also Section 960.

See Chapter 7 of Appendix L, the Oregon Bicycle and Pedestrian Design Guide for additional information about typical pavement sections, drainage, vegetation, rail requirements, illumination, and structures, preventing motor-vehicle access, use of bollards and geometric design. In addition to design requirements in this manual, consider guidance in the AASHTO Guide for the Development of Bicycle Facilities for path design.

845.1.1 Shared Use Path Operations

Provide a clear width between the range of 10 feet – 12 feet on shared use paths. *10 feet is the standard width for a two-way shared-use path; they should be 12 feet wide or more in areas with high use.*

Provide 8 feet of clear width on connection paths. When pinch points occur or where long-term usage is expected to be low, 8 feet is the minimum clear width for two way shared use paths through a design exception

When mode separation is desired between pedestrians and bicyclist, additional width is required. **Provide at least 16 feet of clear width comprising of two 5-foot bike lanes and a 6-foot walking area (Pedestrian Zone).** *Provide a clear width between 16 feet and 20 feet for mode separated facilities. Provide 18 or 20 feet in areas of very high use.* While mode separation is provided typically with striping, low vision and blind pedestrians will need additional tactile cues or TWSI installed to guide them to the intended area along the path. Consult the Senior ADA Standards Engineer for these types of treatments along with Traffic Unit for pavement markings to ensure a consistent message is designed. The entire width of the facility must still meet ADA cross slope and running slope (grade) requirements. Expect pedestrians to cross over and meander over the entire are; mode separation is best achieved with some grade separation via curb (Refer to Section 900s).

At roundabouts, the sidewalk becomes mixed use with bicyclists. Bicyclists operate in one-way flow and two-way flow for pedestrians. Widen the sidewalk width to at least 10 feet where bicyclists enter the sidewalk. **Provide at least 8 feet of clear width on a bike ramp to allow bicyclists to merge from the bike lane onto the sidewalk, 165 feet in advance of the yield line to the circulatory roadway of a roundabout.** See Section 8.6 and Appendix L, the Oregon Bicycle and Pedestrian Design Guide, Figure 1-40. Refer to the RD900s and RD1100s for placement of detectable features at bike ramps.

845.1.2 Parallel Systems to the Highway

Combining pedestrians and bicyclists together along one side of a highway on a shared use path is discouraged on highways without access control but is a preferred facility option for limited access expressways and urban freeways. Crash potential increases when bicycle traffic rides against the normal flow (reverse flow) of motor vehicle traffic on highways with frequent driveway or street access. Since expressways are designed for access restriction to motorists, many of the conflicts are mitigated. Crosswalk entry and exit points to the shared use facility need to be planned in coordination with motor vehicle restrictions on the highway. A separated bicycle facility may not be needed when a well-connected network of bicycle facilities parallel to the freeway or expressway provides the same access that bicycle accommodation on the expressway would provide. The wide shoulder would accommodate occasional bicycles as necessary. Guidelines for providing bikeways on parallel routes are given in Section 946.

845.1.3 Roundabouts

In general, bicyclists will be given a choice to enter a roundabout as a vehicle and occupy a lane until exiting the roundabout, or to use the sidewalks and crosswalks as pedestrians. For these bicyclists, a bike ramp (see Figure 800 below) is provided to exit the bike lane on approach to the roundabout and use the sidewalk and crosswalks in the manner of a pedestrian. This walk results in a shared use path for a small segment along the central circle. The bike ramp is not required to be fully accessible however many of the geometrics are similar as power assisted mobility devices may travel in the shoulder under the ORS and could enter the shared use path with these sloped ramps. (See Part 900) Bike ramps are not intended for pedestrian use and requires additional treatments to communicate to the low vision and blind community it's intended use and function. Bike ramps can be confused with pedestrian curb ramps by vision impaired pedestrians. See Section 821.2 for more information on detectable guide strips.

Bicycle ramps serve bicycle traffic. If there is no sidewalk on the approach road to a roundabout, the entrance ramp to the sidewalk serving the roundabout functions for both bicyclists and pedestrians. Use a pedestrian curb ramp style rather than a bicycle ramp in that case. **An entrance and exit to the sidewalk must be provided where the sidewalk terminates to transition a pedestrian to the shoulder.** Refer to the RD900s for detectable warning treatments at bike ramps. An important function of bicycle ramps that merge onto the sidewalk is the interface between people walking and biking. To mitigate the potential for sight-impaired pedestrians to inadvertently walk onto a bike ramp, tactile edge detection is needed along the border of the walk. One option for a detectable boundary is to use detectable guide strips. **A tactical walking surface indicator shall be included adjacent to bicycle ramps (see Section 821.2.)** *Detectable warning surfaces consisting of truncated dome panels located at the bottom*

of the curb ramp in addition to the detectable guide strip is not prohibited, therefore it does not need to be removed if already in place.

See Section 980 through 983 for more design of bicycle ramps.

Figure 800-73: Bike Ramp Connection to Sidewalk on Roundabout Approach Street

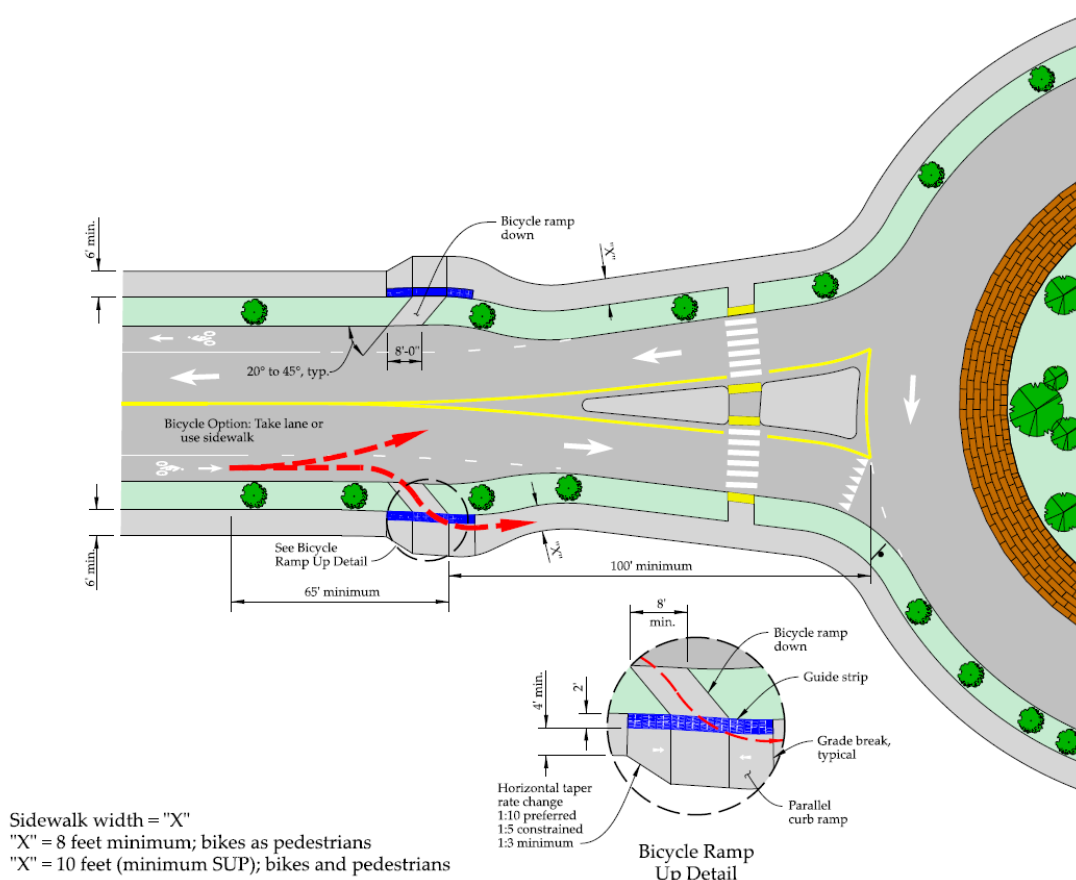

845.2 Shared Use Path Design

Sections 961 through 968 describe geometric design standards for sight-distance, horizontal and vertical curves. Additionally, the AASHTO Bike guide should be consulted for geometric design guidelines. Standards applicable to ODOT are summarized in this section. Though shared-use paths are intended for many users, the bicycle is the appropriate design vehicle because of its higher travel speeds. See Section 924 for design speeds for pathway segments. If design curve length or sight distance does not meet the value shown in Sections 964 and 965, based on the chosen design speed, consult with ODOT roadway unit in the Region Technical Center or the Technical Services Roadway Engineering Unit to discuss whether a design exception is needed.

Design Exceptions are required for path widths less than 10-feet, clear zones less than 2 feet and shy distances less than 1 foot from vertical element such as railings, walls, and fences. See Chapter 7 of Appendix L, the Oregon Bicycle and Pedestrian Design Guide for additional information about typical pavement sections, drainage, vegetation, rail requirements, illumination, and structures, preventing motor-vehicle access, use of bollards and geometric design. For multiple tread trails that accommodate horses, consult the Equestrian Design Guidebook for Trails, Trailheads and Campgrounds.

845.2.1 Horizontal Alignment

A buffer zone with a physical separation of at least 5 feet from the travel realm is required for a shared use path. Sharp curves should be banked with the high side on the outside of the curve to help bicyclists maintain their balance. The design cross-slope is 1.5 percent (2.0 percent finished surface) to provide drainage, in a crown section or shed section. See also Section 965.

845.2.2 Vertical Alignment

When the shared use path is parallel with the mainline alignment and contiguous with the Curb Zone, the walkway shall not exceed the roadway grade under the ADA. An ADA design exception is required where a vertical profile grade is steeper than 4.5 percent (5.0 percent finished surface) on shared use paths that are not on the same highway alignment with an adjacent roadway. To meet ADA requirements, the vertical profile grade of separated shared use path shall not exceed 5.0 percent at finished construction. See Section 966 for more information.

845.2.3 Surfacing

The surface material should be hard enough to be usable by wheelchairs, strollers, and children on bicycles (the roadway should be designed to accommodate more experienced bicyclists). Recycled pavement grindings provide a suitable material. **The surface material must meet ADA surface requirements for the full width of the shared use path.** Refer to the walkway surface and pedestrian access route requirements in Section 810. Depth of asphalt construction is shown in the RD600 series for Shared use path pavement details. Shared use paths occasionally need to allow access for maintenance vehicles which will increase the asphalt pavement foundation and final surfacing depths.

845.2.4 Clear Width

The entire width of a shared use path shall be clear of obstructions. Additionally, sidewalks that include bicycle traffic mixed with pedestrian traffic should have 8 feet of clear width to allow for a minimum width multi-use pathway condition. In locations where bicycle riding on the sidewalk is prohibited by statute, appropriate signage is necessary to inform bicyclists.

845.2.5 Clear Zone

A 2-foot clear zone distance on both sides of a shared-use path is required. *It is desirable to have 3 feet or more.* The clear zone area should be graded level, flush to the path and free of obstructions to allow recovery by errant bicyclists. This applies to cut-sections, where falling debris can accumulate, stimulating weed growth, further restricting the available width.

845.2.6 Vertical Clearance

Provide a vertical clearance above the finished surface of the shared use path at least 10 feet for the full width of the pathway. The standard clearance to overhead obstructions is 10 feet to ensure adequate clearance of a person upright on a mobility device, riding a bicycle, and for occasional maintenance vehicle or equipment. Where fixed objects or natural terrain prohibit the 10 feet of vertical clearance, 8 feet is the minimum vertical clearance.

Section 850 Pedestrian Trail Design

Many recreational trails cross the state highway system and are available for pedestrian use. Users may use these trail systems as transportation links, and use is not prohibited except when signed for a specific mode. Multi-use trails may include accommodation of additional users, such as equestrians. Highways that cross these pathways should have access to the trail systems. If a highway has a separate grade crossing with a pathway, provide a short path connection from the pedestrian and bicycle facilities along the highway to the pathway. See Section 845 and Section 900 for at-grade path crossings. See Appendix L, the Oregon Bicycle and Pedestrian Design Guide, pages 7-13 through 7-16 for design guidance on under-crossings and over-crossings.

A trail is defined as a pedestrian route developed primarily for outdoor recreational purposes. For designing recreational trails in more rural settings, refer to US Access Boards "Accessibility Standards for Federal Outdoor Developed Areas" published May 2014. For multiple tread trails

that accommodate horses, consult the Equestrian Design Guidebook for Trails, Trailheads and Campgrounds.

Section 855 Emergency Egress Routes

Section Reserved.

Section 890 References

- Nondiscrimination on the Basis of Disability in State and Local Government Services, 28 CFR Part 35 (2010).
- Department of Justice. (2010). 2010 ADA Standards for Accessible Design.
- Americans with Disabilities Act (ADA) Accessibility Guidelines for Building and Facilities; Architectural Barriers Act (ABA) Accessibility Guidelines, 36 CFR Part 1191, Appendix B and Appendix D.
- Hack, Jennifer (2020). Service Dog Training Guide. Rockridge Press.
- Proposed Public Rights-of-Way Accessibility Guidelines (2011).
- Supplemental Notice Proposed Rulemaking on Public Rights-of-Way Accessibility Guidelines (2013).
- David Kent Ballast Architectural Research Consulting (2011). Dimensional Tolerance in Construction and for Surface Accessibility Research Report for the US Access Board.
- Public Rights-of-Way Access Advisory Committee (PROWAAC) (2007). Special Report: Accessible Public Rights-of-Way Planning and Designing for Alterations.
- Oregon Transportation Commission. (2016) Oregon Bicycle and Pedestrian Plan.