

HEALTH

DIVISION

OREGON DEPARTMENT OF HUMAN SERVICES

Drinking Water Program

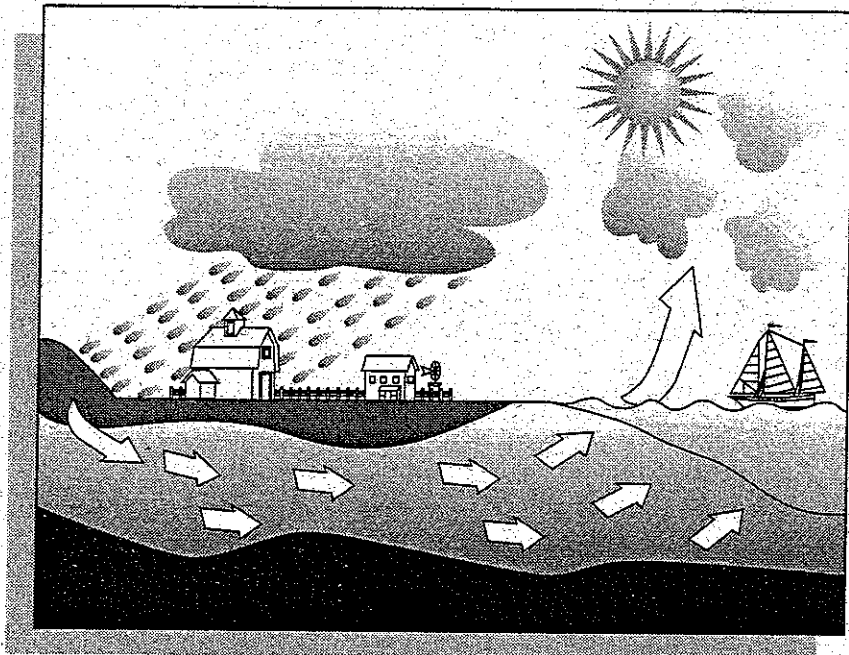

Groundwater



Revised November 1999

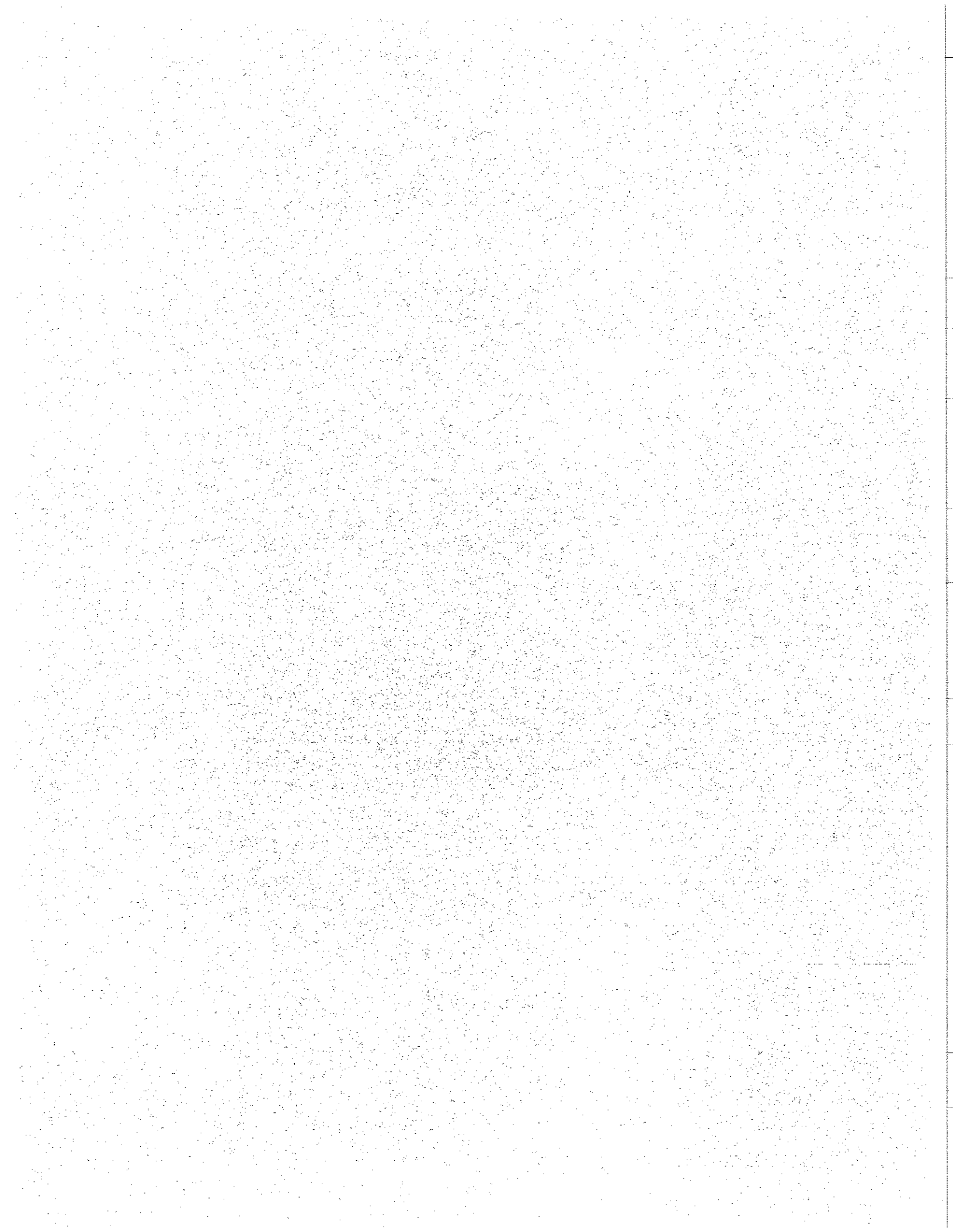

Table of Contents

Introduction	1
Groundwater Usage	1
Developing the Conceptual Model	2
The Hydrologic Cycle	2
Where Does Groundwater Occur?	3
<i>Porosity</i>	3
<i>Permeability</i>	4
<i>Unsaturated and Saturated Zones</i>	4
Aquifers	5
<i>Unconfined Aquifer</i>	5
<i>Confined Aquifer</i>	6
<i>Perched Water Tables</i>	6
<i>Springs</i>	6
How Does Groundwater Move?	6
<i>Groundwater Flow Direction</i>	7
Groundwater Velocity	7
<i>Hydraulic Conductivity</i>	11
<i>Hydraulic Gradient</i>	11
<i>Darcy's Law</i>	11
Base Flow to Streams	13
Hydraulic Connection	14
Contamination of Groundwater	14
Contaminant Sources	16
Movement of Contaminants in Groundwater	16
<i>Aquifer Characteristics</i>	17
<i>Contaminant Characteristics</i>	17
Persistence of Contaminants in Aquifers	17
<i>Nonaqueous Phase Liquids (NAPLs)</i>	18
Groundwater Protection	18
Wellhead Protection	19
Delineation of Wellhead Protection Areas	20
<i>Calculated Fixed Radius</i>	20
<i>Analytical Methods</i>	22
<i>Numerical Methods</i>	22
Inventory of Potential Contaminants	22
Management Strategies within Wellhead Protection Areas	23

Well Construction	23
Casing Seal	24
Aquifer Commingling	24
<i>Lithology</i>	24
<i>Hydraulic Head</i>	24
<i>Water Chemistry</i>	25
Water Rights	25
Useful Data for Public Water Systems to Collect	25
Well Log Inventory	25
Static Water Levels	25
Pumping Rates	25
Aquifer Test	25
Common Ion Chemistry	26
Glossary	27
Appendix	32
Oregon's Drinking Water Protection Program	33
Source Water Assessment Fact Sheet	35
Delineation of a Drinking Water Protection Area: Calculated Fixed Radius	
Method	36
Delineation of a Drinking Water Protection Area: Groundwater Sources	38

Introduction

Where does groundwater come from? Where does it occur beneath the surface? How fast does it move and in what direction? How can it become contaminated? These are all very important questions that those of us who depend on groundwater as a source of drinking water have to be able to answer if we are going to be successful in using and protecting this resource. Although there is still the perception held by some that groundwater is naturally pure and protected from contamination, there is abundant evidence to the contrary.

Everyone has heard "horror stories" about the large city that has spent millions of dollars to develop a wellfield that they cannot use because of potential contamination. Or the small community that had to supply its customers with bottled water for over two years because their groundwater source was contaminated. Another community has spent over two million dollars to establish a treatment system and now must maintain it at approximately \$100,000 per year for as long as the system exists.

We now understand that the best way to avoid the increased costs and personnel requirements, not to mention the public relations problems, associated with a contaminated water supply is to protect the source from contaminants now. To do so requires an understanding of how our particular groundwater machine works. We must answer the questions posed at the start of this section. This document is designed to provide a basic understanding of how groundwater works and how we can develop plans to protect our groundwater resource.



Groundwater Usage

Groundwater is an important source of drinking water throughout the country. The Environmental Protection Agency estimates that nationwide, approximately 95,000 communities derive their drinking water in part from groundwater sources. There are probably in excess of ten million private wells in the United States. In Oregon, 77 percent of our community systems, 97 percent of the nontransient noncommunity systems, and 93 percent of the noncommunity systems rely on groundwater. These systems serve over 750,000 Oregonians. In addition, it is estimated that there are in excess of 100,000 private wells in the state.

In 1985 the U.S. Geological Survey performed a survey of groundwater usage throughout Oregon. They estimated that on a *daily* basis, over 660 million gallons of groundwater are used within the state.

Most of this (≈72 percent) is utilized by agriculture, whereas approximately 11 percent (72 million gallons) is used for domestic and commercial activities.

As potential surface water sources decrease, either because of prior allocations or because surface water requires more extensive and expensive treatment, the demand for groundwater as a drinking water source increases. This is a problem not only of quantity but also quality. With some notable exceptions, available groundwater can be found in most areas. Those exceptions include those areas where groundwater is being extracted at rates that exceed the replenishment rate. Continued or increased mining or overdrafting of groundwater in these areas will produce a depleted resource at some point in the future. In still other areas available groundwater is at considerable

depth and/or in low quantities, and not always at a quality level that can be readily used for drinking water.

These issues reinforce the need to understand and protect existing resources. We can no longer rely on the option of “drilling a new or deeper well” if our resource becomes contaminated. Increased uses and abuses of groundwater are beginning to limit our options. The best management strategy is to develop a plan to protect the source of groundwater that supplies our drinking water. As indicated above, the first step in that plan is to understand how the particular groundwater system that supplies your water operates.

Learning about your system is called developing a **conceptual model** of the groundwater system. A conceptual model consists of identifying where the groundwater occurs, how it is replenished, how it is being used, what direction it is moving and how fast. The sections below describe the various parts of developing a conceptual model. We will return later in this manual to how to use it to develop a management plan.

Developing the Conceptual Model

The Hydrologic Cycle

Where does groundwater come from? Ultimately, whether we are talking about a shallow well or a deep well, groundwater is replenished or **recharged** by precipitation. The distribution of precipitation on the earth is controlled by the **hydrologic cycle** (Fig. 1). As indicated in the figure, the hydrologic cycle is a major machine on the planet, controlling the distribution of water on the earth's surface. It is solar driven. The heating of the surface by the sun causes water at the surface to be evaporated, i.e. to be transferred as a vapor or gas to the atmosphere. The fact that solar heating is not uniform everywhere on earth causes the atmosphere to move, rising in some areas

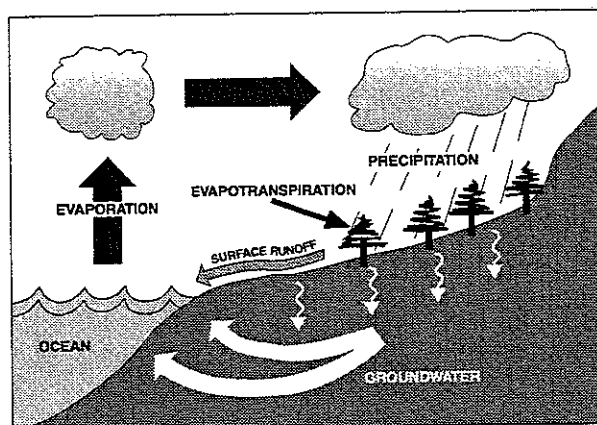

Figure 1. The solar-driven hydrologic cycle controls the distribution of water on the Earth's surface. Water is evaporated off the sea surface and carried across the continents where it falls as precipitation. Some of that precipitation contributes to surface water, some to the life cycles of plants and animals, and some sinks into the ground to become groundwater. All water eventually moves through the cycle to return to the ocean.

and sinking in other areas. This transfer of atmosphere, carrying water vapor, causes our weather and distributes precipitation across the globe.

Figure 1 illustrates the various ways that water is distributed over the earth and shows the various pathways that water can take as it moves through the cycle. In describing the cycle, it is convenient to begin with the ocean. Annually, over 3 feet of water is evaporated off the ocean surface. As the atmosphere carrying the water vapor ascends, much of it cools and condenses, forming clouds and rainfall. As a consequence, over 90 percent of that water is returned directly to the ocean as precipitation. The remaining water vapor is carried over the continents where ultimately it is removed as some form of precipitation.

Precipitation that falls on the earth's surface may be collected as surface water runoff, may be evaporated back into the atmosphere, may be stored temporarily as snow or ice, may be transpired by plants, or **may infiltrate** into the subsurface. Water that infiltrates, or **percolates downward from the surface**, is the source of recharge to groundwater.

Where Does Groundwater Occur?

Important in understanding how groundwater occurs in the subsurface is knowledge about the kinds of geologic materials that make up the subsurface. What sort of material is found below the soil zone? There is a vast number of different types of rocks that are known to make up the earth. The different types are not as important here as is their physical characteristics, particularly their porosity and permeability.

Porosity. Most geologic materials are not completely solid, they contain open spaces or pores. These open spaces may be primary, if they formed at the same time the material did, or secondary if the open spaces formed later than the material. In **sediments** such as **alluvium**, e.g. river sands and gravels, the pore spaces are

primary, occurring as openings between individual grains. In an igneous rock such as **granite** or **basalt**, the openings are generally secondary, occurring as individual fractures that have developed after the rock crystallized from a molten state. Lava flows like basalt may have primary porosity as well, in the form of gas bubbles (vesicles) that were trapped ("frozen" in) as the lava solidified.

The porosity is the fraction of the rock that is open space. A porosity of 0.2 means that 20 percent of the material consists of open spaces. The greater the amount of open spaces or voids, the greater is the porosity of the material. Porosity in geologic materials varies from nearly zero (<0.001) in unfractured igneous rocks to over 0.5 in **fine-grained** sediments such as silt or clay or in highly fractured rock (Table 1).

Table 1. Approximate values of porosity and hydraulic conductivity for various aquifer materials (from Domenico and Schwarz, 1990, *Physical and Chemical Hydrogeology*, John Wiley & Sons, New York, 824p.).

Material	Hydraulic Conductivity (feet/sec)	Porosity
Sediments		
Gravel	0.001 - 0.1	0.24-0.38
Coarse Sand	3.0×10^{-6} - 2.0×10^{-2}	0.31-0.46
Fine Sand	6.0×10^{-7} - 6.0×10^{-4}	0.26-0.53
Silt	3.0×10^{-9} - 6.0×10^{-5}	0.34-0.61
Clay	3.0×10^{-11} - 1.5×10^{-8}	0.34-0.60
Sedimentary Rocks		
Sandstone	1.0×10^{-9} - 2.0×10^{-5}	0.05-0.30
Siltstone	3.0×10^{-11} - 5.0×10^{-8}	0.21-0.41
Shale	3.0×10^{-13} - 6.0×10^{-9}	0-0.1
Igneous/metamorphic Rocks		
Basalt (dense)	6.0×10^{-11} - 1.2×10^{-6}	0-0.05
Basalt (frac)	1.2×10^{-6} - 6.0×10^{-2}	0.05-0.35
Unfractured Ign/Met Rocks	1.2×10^{-13} - 6.0×10^{-10}	0-0.05
Fractured Ign/Met Rocks	2.4×10^{-8} - 1.0×10^{-3}	0-0.1

Characteristics Affecting Hydraulic Conductivity and Porosity

Hydraulic Conductivity:

Increased by: presence of sand or gravel, increase in sorting by size, presence of stratification, unconsolidated character and high secondary porosity.

Decreased by: presence of clay, poor sorting, unstratified character, cementation and/or compaction.

Porosity:

Increased by: increase in sorting, rounded grains, small particle size, unconsolidated character and high secondary porosity.

Decreased by: poor sorting, irregular shaped particles, unstratified, large particle size, cementation and/or compaction.

Exercise 1. A sediment consisting of coarse sand has a porosity of 0.35. What would be the volume in cubic feet of the pore spaces in a cubic meter of that sediment?

Permeability. A related physical property of geologic materials that is important to understanding the occurrence and movement of groundwater is the **permeability**. Permeability is a measure of how readily a fluid, in this case water, moves through openings in solid material. This depends on the porosity, the size of the openings and how interconnected are the openings.

Among the most permeable of geologic materials are **coarse-grained** sands and gravels. These materials have relatively high porosities (0.25 to 0.50) and the pore spaces are interconnected, in other words the individual pore spaces are not isolated.

Importantly, the pore spaces are relatively large, allowing the easy movement of water through them.

Among the least permeable materials are unfractured igneous rocks, with virtually no pore space, and fine-grained materials such as silts, clays and volcanic ash. In materials such as silts and clays, the porosity is relatively high (0.35-0.60). However, because the pore spaces are very small, water cannot easily move through them. As a result, such materials are often impermeable.

Unsaturated and Saturated Zones. Figure 2 indicates that if we drill a well, we pass through a certain depth where the pore spaces of the material are filled with air, or a mixture of air and water. This is referred to as the **vadose zone** or **unsaturated zone**. The term unsaturated is applied because the pores are not filled with water. In other words, the material is not saturated with water.

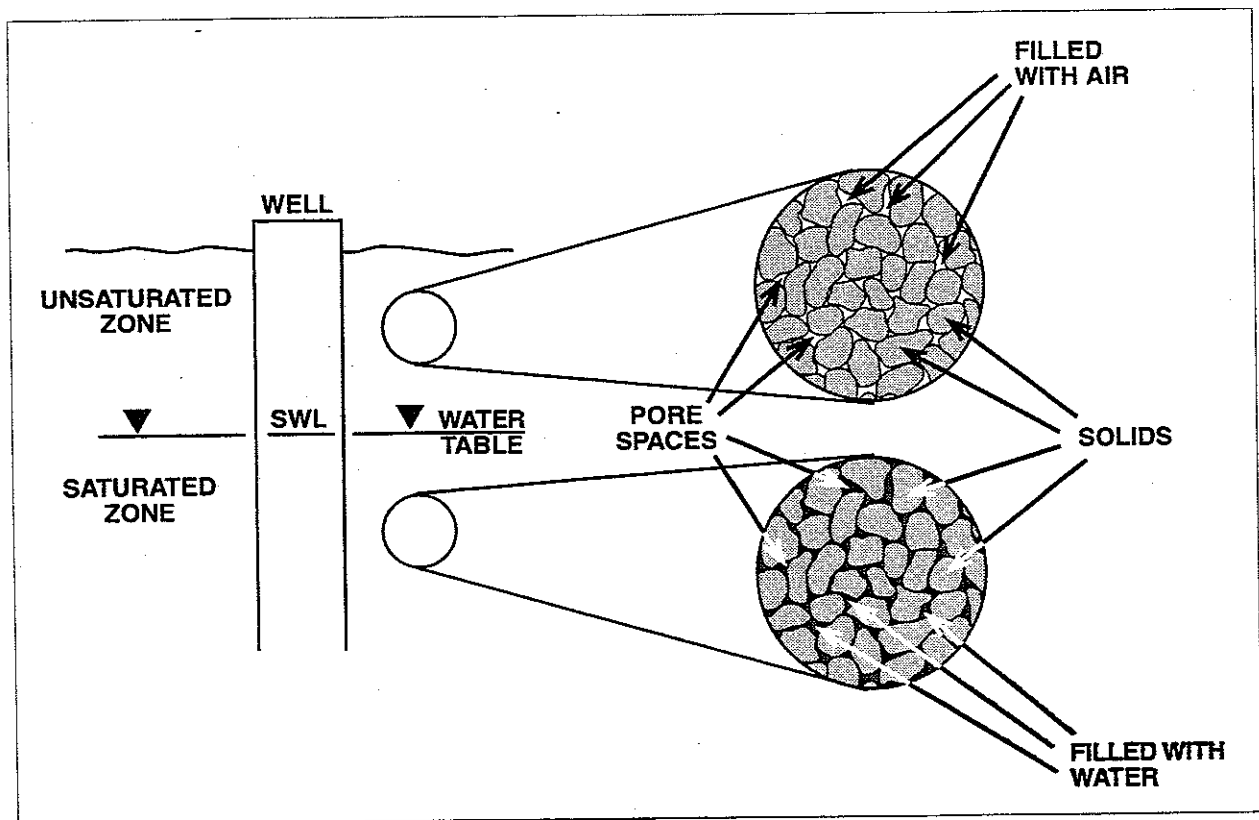

Figure 2. From the surface down to the water table, all the open spaces (i.e. pore spaces) in the soil and rock material are filled with air or with air and water. This unsaturated zone will not yield water to wells. Below the water table, all the pore spaces are filled with water. This saturated zone is where groundwater occurs. The source of the groundwater is infiltrating precipitation.

If we drill far enough, we eventually will get into material in which the pore spaces are filled with water. This is the **saturated zone**. The geologic materials here contain as much water as possible, i.e. they are saturated. The top of the saturated zone is often referred to as the **water table**.

So how does the configuration illustrated in figure 2 develop? Recall from the concept of the hydrologic cycle (Fig. 1) that some precipitation infiltrates into the ground. The water that infiltrates from the surface passes downward through the unsaturated zone under the influence of gravity. Think about what would happen if you poured water into a bucket that was filled with sand or gravel. Most of that water would seep or infiltrate into the sediment. It would flow downward through the pore spaces and would eventually begin to fill those pore spaces at the bottom of the bucket. Eventually you end up with a saturated zone at the bottom where the water accumulates and an unsaturated zone at the top where the infiltrating precipitation is passing through.

Exercise 2. If the coarse sand in Exercise 1 were saturated with water, how many gallons of water would occur in a cubic meter of that sediment?

Aquifers. Once water reaches the saturated zone it is called groundwater. If the solid material of this saturated zone is permeable and can yield water to a well in sufficient quantity to supply user needs, it is referred to as an **aquifer**. Clearly, groundwater does not occur as underground rivers, lakes or veins. Rather, groundwater occurs and moves through interconnected pore spaces where those pores are completely filled with water.

Aquifers may consist of an entire geologic unit, such as a saturated sand deposit, they may consist of a part or parts of a larger geologic formation, for example several

different water-bearing gravel layers in an alluvial formation, or of different rock types that are connected hydraulically, such as interbedded lava flows and sedimentary deposits.

If we continue to drill deeper in figure 2, we might find that we would encounter different water-bearing units of the same aquifer, or perhaps drill into other aquifers at depth (Fig. 3).

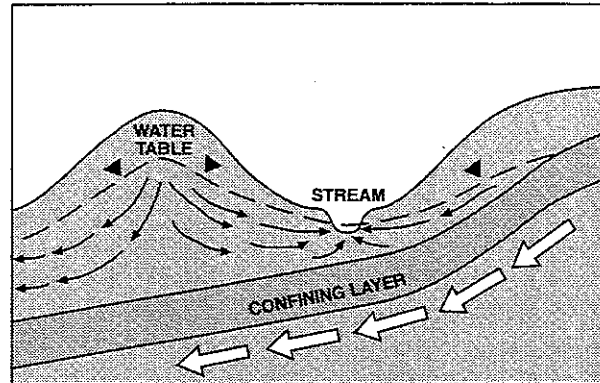

Figure 3. More than one aquifer may occur at depth. Shallow aquifers, with no impermeable layers (confining layers) to separate the water table (dashed line) from the surface are referred to as unconfined aquifers. Note that the shape of the water table often mimics that of the surface. Groundwater flow (arrows) is from where the water table is high to where the water table is low. Deeper aquifers, separated from the surface by confining layers, are referred to as confined aquifers. Groundwater flow direction in a confined aquifer is often unrelated to surface topography and therefore may be different from that in the overlying unconfined aquifer.

One way of recognizing when we pass from one aquifer to another during the drilling process is a significant change in the level of water in the well. If we allow the water in the well to come to rest, i.e. we are neither drilling nor pumping, what we are observing is the **static water level (SWL)**. The SWL, the vertical distance from the surface to the water level standing in the well, is an indication of the **hydraulic head** within the aquifer. We will define this more completely below, but it should be noted that different aquifers often have different SWLs. It is important to note that in Oregon it is illegal to have a well that simultaneously taps into **more than one aquifer** (see construction standards below).

Unconfined Aquifer. The typical shallow aquifer is an unconfined aquifer. There are no

low permeability layers between the aquifer and the surface. An unconfined aquifer is often called a water table aquifer because the water table forms the upper surface of the aquifer. Recharge to an unconfined aquifer is local and the water table moves up and down depending on the relative rates of recharge (precipitation or imported irrigation) and discharge (to wells, springs or streams). In an unconfined aquifer, the SWL will be at the same elevation as the top of the aquifer. As discussed below, unconfined aquifers are particularly **susceptible** to contamination from the surface.

Confined Aquifer. Deeper aquifers tend to be separated from the surface by low permeability zones, referred to as **confining layers**. There is no minimum depth for a confined aquifer, some may be relatively shallow, i.e. less than 100 feet. Although exceptions occur, confined aquifers tend to be recharged at some distance away, where the aquifer is at or near the surface (recharge area for the confined aquifer in figure 3 is off the figure to the right).

An example might be a well that draws from a confined basalt aquifer in eastern Oregon. Many of these aquifers are recharged in the higher areas, e.g. the Blue Mountains, miles from the wellhead. As implied, an aquifer may be unconfined in some areas and confined in other areas depending on local geology.

The SWL in a confined aquifer is characteristically at a higher elevation than is the aquifer. For example, if you drill into a confined aquifer that is 200 feet below the surface, the hydraulic head of the water in that aquifer may be sufficient for the water to rise to only 50 feet below the surface. Such **artesian** behavior is characteristic of confined aquifer systems. If water actually reaches the surface and flows out, the well is referred to as a **flowing artesian well**.

Figure 3 illustrates why confined aquifers tend to have artesian characteristics. As shown, the confined aquifer extends to a

higher elevation at the right hand side of the diagram. Assuming that the confined aquifer layer is saturated throughout, and since the water in the aquifer is constrained to flow below the confining layer (hollow arrows in figure 3), groundwater will rise (i.e. will "seek its own level") above the aquifer in any well drilled into the confined aquifer where the aquifer occurs at a lower elevation.

If a well is drilled into the confined aquifer in the vicinity of the stream, the well may exhibit flowing artesian characteristics because the ground elevation is significantly lower than the level of the water in the confined aquifer in the right hand side of the diagram. The total head on the water may be such that it pushes the water to an elevation greater than the ground surface.

Exercise 3. As a well constructor drills a well, he encounters the following water-bearing zones and associated static water levels (SWL): zone 1: 15 feet thick, SWL = 23 feet; zone 2: 20 feet thick, SWL = 23 feet; zone 3: 12 feet thick, SWL = 23 feet; zone 4, 18 feet thick, SWL = 6 feet. If he completes the well at this point, continuing to draw from all four zones, would this well meet state standards? Why or why not?

Perched Water Tables. As water infiltrates from the surface, it may encounter limited zones of low permeability within the unsaturated zone. Downward percolating water may be retained here, i.e. perched, for short periods of time. During periods of high recharge, a perched water table may serve as a source of water for shallow wells. These perched zones generally have only limited storage, however, and frequently are exhausted during periods of limited recharge.

Springs. Permanent springs occur where groundwater gains access to the surface. Temporary springs and seeps (see below)

occur during periods of high recharge as a result of either perched water tables reaching the ground surface or as a result of interflow (see below).

There are many different ways by which a permanent spring could develop. Figure 4 diagrams two of the most common varieties. In Figure 4a., (left side of diagram), infiltrating water accumulates on top of a low permeability confining layer. Because the water cannot continue to flow downward, it accumulates and flows laterally along the layer. If this layer is exposed at the surface, groundwater will discharge at this point as a spring.

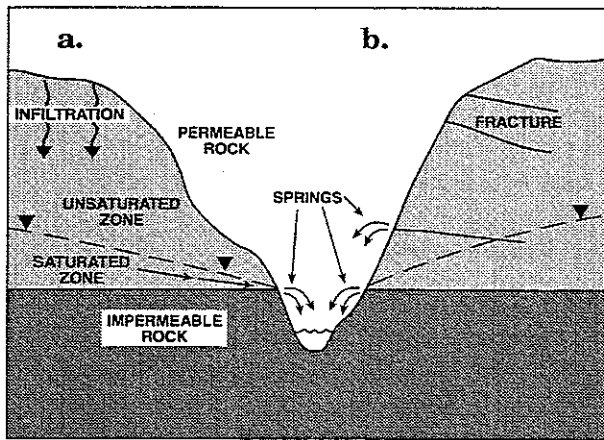

Figure 4. Springs occur when groundwater is provided access to the surface. Two cases are shown here. In **a.**, infiltrating precipitation encounters a low permeability layer and moves laterally along it. If that layer is exposed at the surface, groundwater emerges as a spring just above it. In **b.**, fractures provide access of groundwater to the surface.

As discussed above, a number of differing types of geologic materials can serve as confining layers: a clay or silt layer, a dense lava flow, volcanic ash, cemented sediments such as sandstone, etc.

An alternative situation is presented in Figure 4b., (right side of figure), where fractures provide access of groundwater to the surface. As shown, if the head configuration is appropriate, groundwater may move up the fractures and discharge at the surface.

If the size of the recharge area for the spring is large and recharge is consistent, the discharge volume can be high (>100,000 gallons/minute). This rate can be relatively

constant year around because water infiltrating over a very large area is geologically directed to a single discharge area.

How Does Groundwater Move?

Groundwater Flow Direction. Above, in conjunction with the description of permeability, it was implied that groundwater moves through interconnected pore spaces or along discrete fractures, depending upon the type(s) of openings within the aquifer. The driving force for groundwater movement is hydraulic head. Whether we are considering a confined or unconfined aquifer, the total hydraulic head, measured in units of length (feet or meters), is the sum of the **elevation head** and the **pressure head** and is equal to the elevation of the SWL (Fig. 5). This head value applies to the head at the level at which water is entering the well.

The term potentiometric surface is used to describe the distribution of hydraulic head in confined and unconfined aquifers. For

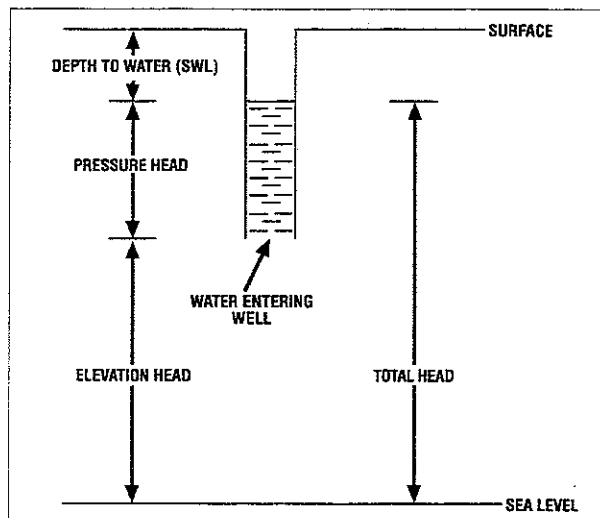

Figure 5. The hydraulic head (total head) at the point where water enters the well is equal to the sum of the pressure head (the weight of the water above the entry point) and the elevation head (the vertical distance above some reference elevation (e.g. sea level)). The hydraulic head for the aquifer at a well site is equal to the *elevation* of the static water level. Groundwater will move from areas where the hydraulic head is high to areas where the hydraulic head is lower.

unconfined aquifers, the term **water table** can be used in place of **potentiometric surface**. We do not apply the term **water table** to confined aquifers.

Groundwater tends, then to move from areas of high hydraulic head to areas of low hydraulic head (Fig. 6). Because the total head consists of both the elevation and pressure heads, there tends to be a vertical as well as a horizontal gradient. As a result, the actual path that groundwater follows is curved as illustrated in figure 6. Also illustrated in the figure is the phenomenon of **interflow**. This occurs when water moves laterally in the downgradient direction, but within the unsaturated zone. This can often lead to seeps in the downslope direction.

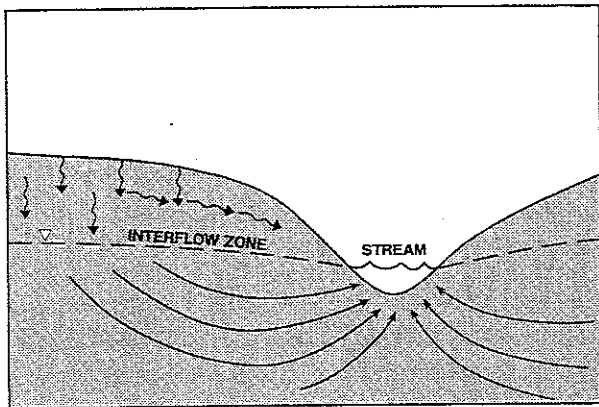

Figure 6. Groundwater gradients occur both horizontally and vertically. As a result, the movement of groundwater (arrows) often is curved, rising upwards in areas of discharge such as a stream. Groundwater supplies a portion (baseflow) of the flow within perennial streams. In some cases where infiltration is high, locally low permeability layers within the unsaturated zone may divert water laterally as interflow. These often produce seeps on hill sides.

If we measured the SWLs for a number of wells *all in the same unconfined aquifer* we would find in general that the heads would not all be at the same level. In fact, just as the land surface has topography, so does the water table. Extending the analogy, just as surface water tends to flow downhill, so does groundwater tend to move downgradient, or down the slope of the water table or potentiometric surface.

In an unconfined aquifer, it is common to find that the water table often resembles the land surface. In other words, ridges on the water table tend to lie below ridges at the surface. This is primarily because of the local recharge to unconfined aquifers. We cannot infer the shape of the potentiometric surface of confined aquifers. In fact, as

indicated in figure 3, groundwater in a deeper confined aquifer may be moving in an entirely different direction than groundwater movement in the shallower unconfined aquifer.

Let's examine more closely how we would determine the direction of groundwater flow for a given situation. Figure 7a shows a map in which the elevations of SWLs for wells in a confined aquifer have been plotted. [The elevation of a SWL is determined by subtracting the SWL from the elevation of the ground surface at the wellhead.] These data represent the distribution of hydraulic head across the map area.

In figure 7b the hydraulic head data have been contoured to reveal the shape of the potentiometric surface. Contours (solid lines in figure 7b) are drawn to represent constant SWLs, in the same sense as those on a topographic map where each contour represents a constant surface elevation.

Drawing the contours gives us a better picture of the configuration of the potentiometric surface and allows us to predict in a more accurate manner the direction in which groundwater will flow. To make that prediction, groundwater flow lines can be drawn (dashed lines in Fig 7b) so that they are perpendicular (at right angles) to the contours. In the figure it is apparent that groundwater will flow from northeast to southwest in the diagram.

Often we do not have enough data to draw contours. Can we estimate groundwater flow with less information? Figure 8 indicates that an estimate can be made with as few as three SWLs. As in the example in figure 7, it is very important that all three wells are deriving water from the same aquifer, preferably from the same relative depth. In the example, wells 1, 2 and 3 have SWL elevations of 310, 318 and 330 feet, respectively. In order to estimate the direction of groundwater flow in the vicinity of these wells the following procedure is followed.

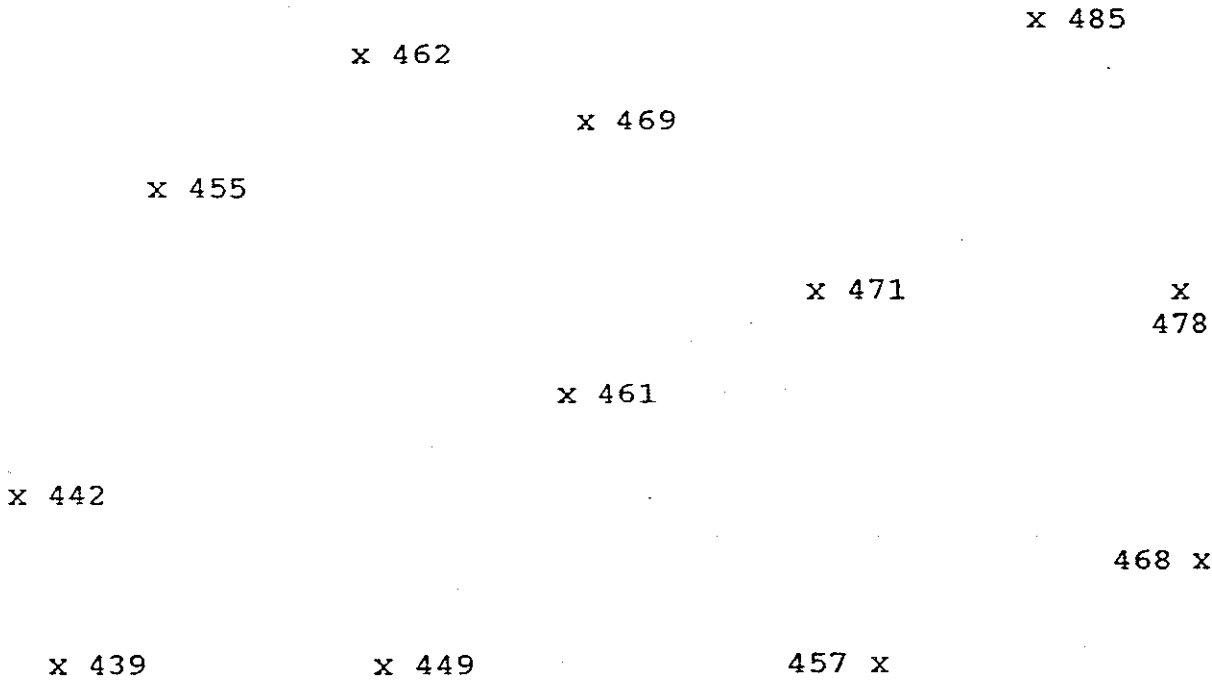

Figure 7a

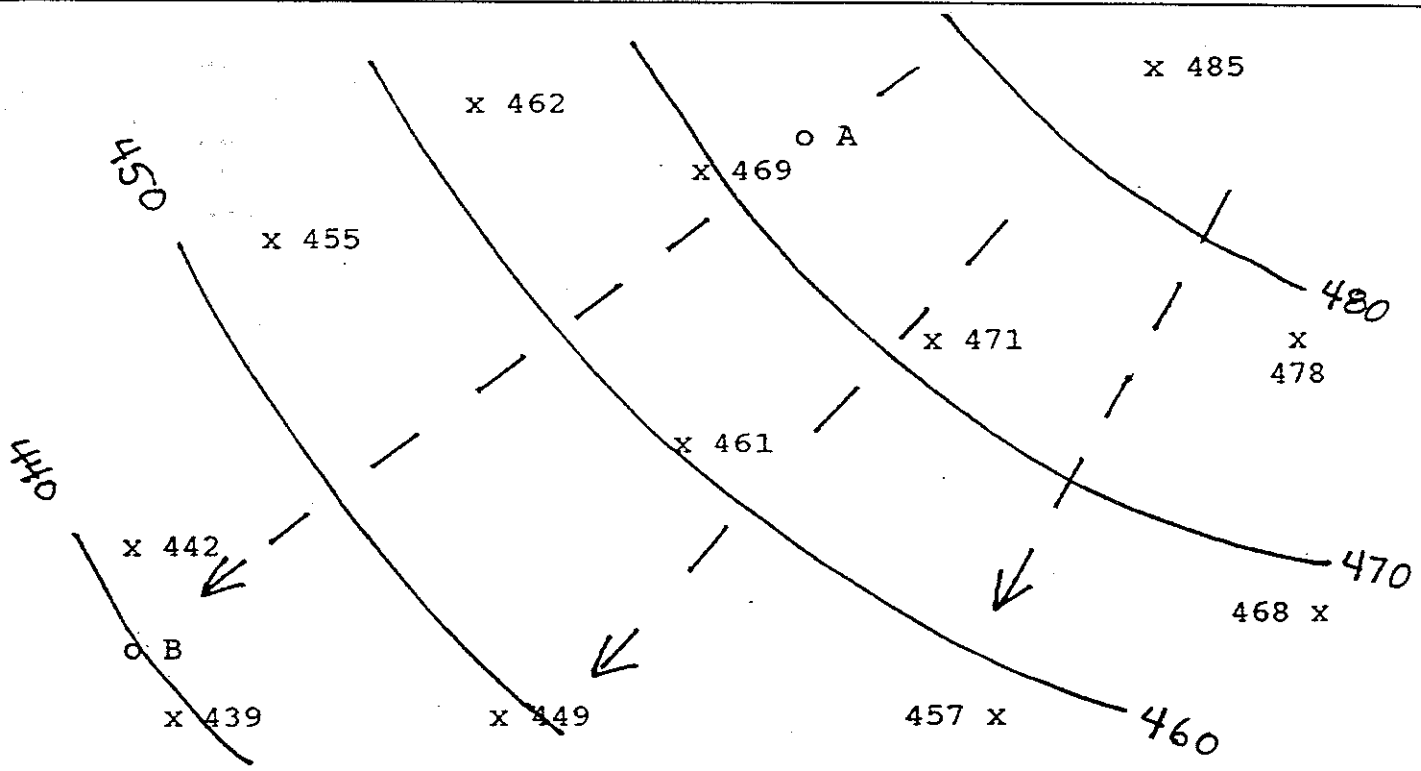

Figure 7b

Figure 7a. Map showing the distribution of wells in an area. Numbers correspond to SWLs in feet above sea level. 7b. Map as in a. contoured to show the potentiometric surface. Contour text under Darcy's Law. Dashed arrows reflect approximate groundwater flow direction. Scale on both maps is 1 inch = 3000 feet.

- a. construct a line between the wells having the lowest and highest SWL (1 and 3 in this example).
- b. measure the length of the line segment 1-3 (2.0 inches in the example).
- c. calculate the elevation difference between the SWLs of the lowest and intermediate well ($318 - 310 = 8$ feet in the example).
- d. calculate the elevation difference between the lowest and highest SWL observed in the wells ($330 - 310 = 20$ feet in the example).
- e. determine the distance along segment 1-3 to the intermediate elevation ($[(8/20) \times 2.0 \text{ inches}] = 0.8$ inches in the example).
- f. measure 0.8 inches along line 1-3 measuring from the lowest elevation (well 1). This is the point along line 1-3 inferred to be at an elevation of 318 feet.
- g. draw a line from the intermediate well to the measured point on line 1-

3. This line connects SWLs of equal elevation and therefore approximates the orientation of the contours on the potentiometric surface.
- h. a line drawn perpendicular to the inferred contour will approximate the direction of groundwater flow in the vicinity of the wells.

An important point in this procedure is that it is assumed that the aquifer is granular, in other words something like a gravel or sand. If the aquifer is fractured, groundwater would still move down gradient, but would be constrained to move along fractures, which might be at an angle to the predicted flow direction. As an example, if there were prevailing fractures oriented 30 degrees from the gradient direction, groundwater would flow in the general downgradient direction, but would be constrained to move along the fractures, 30 degrees from the predicted direction. In Figure 9, the impact of two sets of fractures on the groundwater flow direction is illustrated.

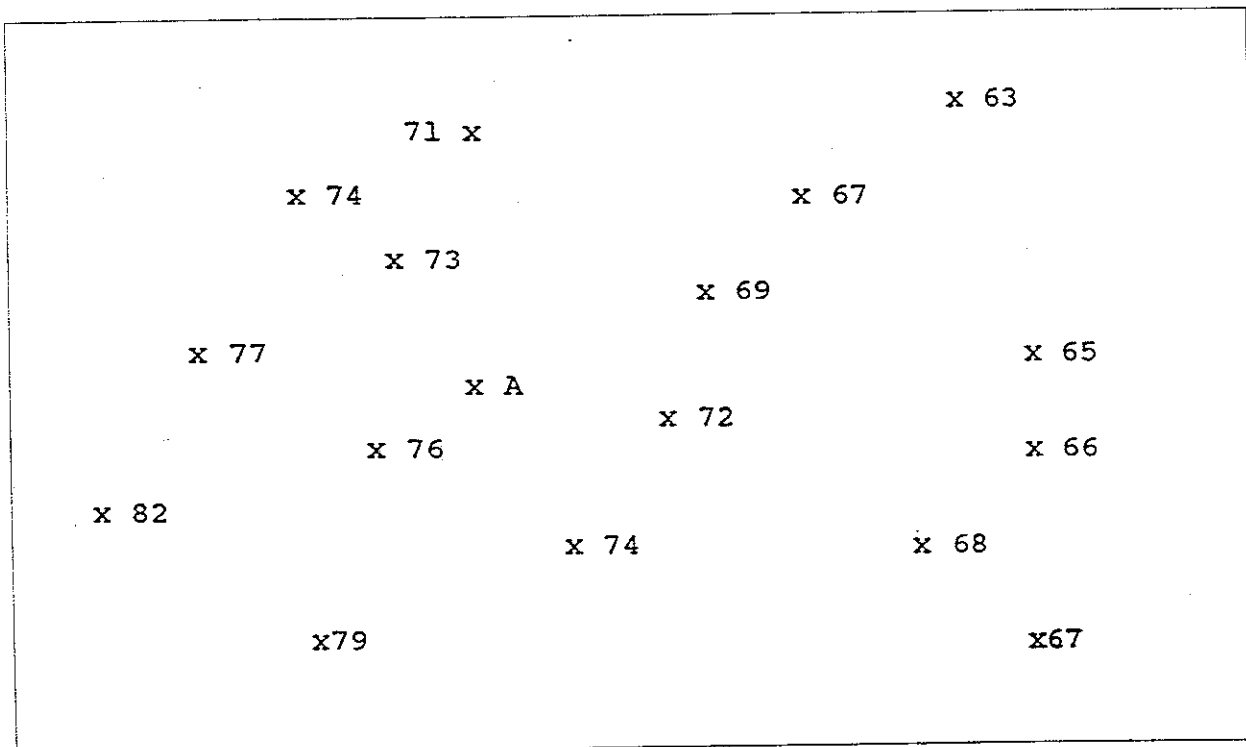

Exercise 4. In the diagram above, the elevation of the static water levels are shown. Contour the potentiometric surface by drawing the 80, 75, 70 and 65 foot contours. Draw lines indicating the direction of groundwater flow.

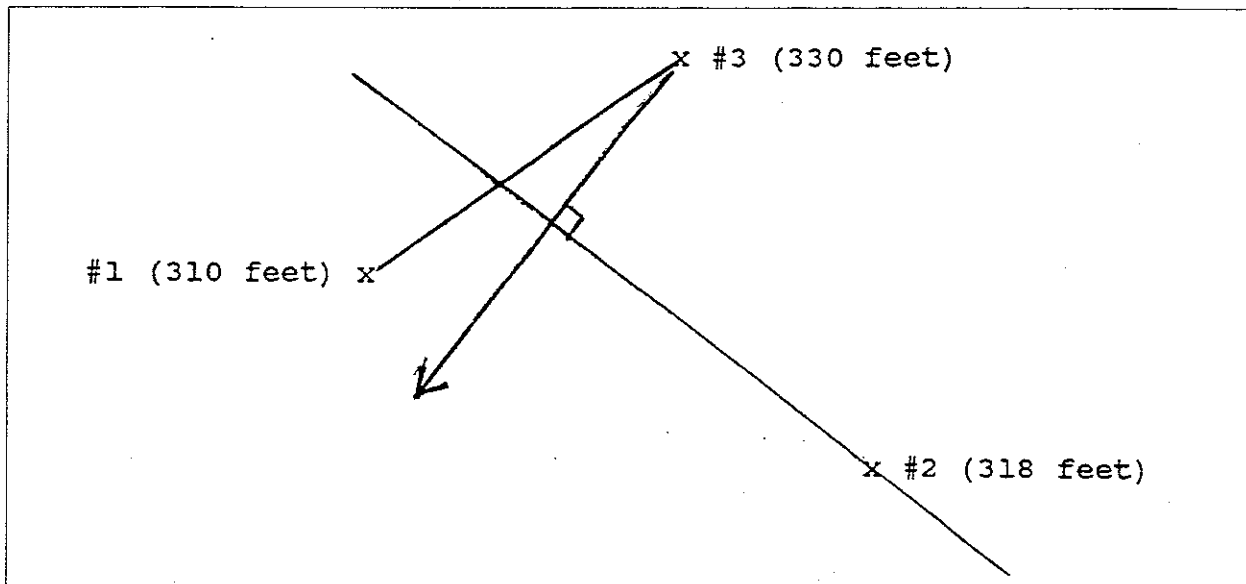

Figure 8. Determining approximate groundwater flow and gradient using 3 wells completed in the same aquifer (see text for explanation). Numbers given for each well represent the elevation of the static water level.

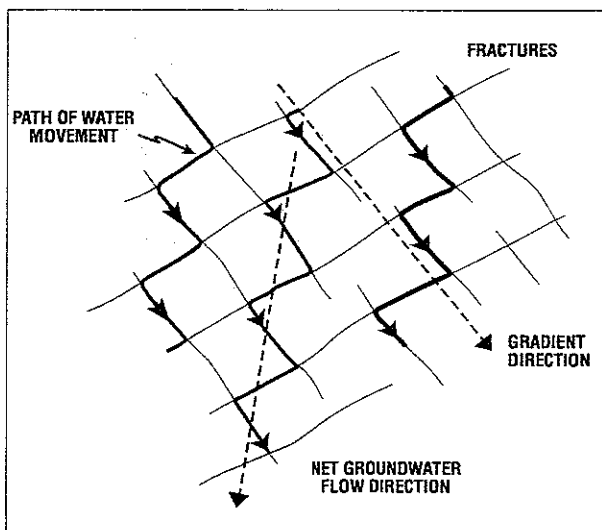

Figure 9. Impact of fractures in bedrock on the direction of groundwater flow. Gradient direction as shown. Light lines represent two fracture systems approximately perpendicular to one another. Path of water moving through the bedrock are shown as heavy black lines. Note that water is moving in a general downgradient direction, but is constrained to move along available fractures. As a consequence, actual groundwater movement is at an angle of approximately 40 degrees to direction predicated solely by the gradient direction.

Groundwater Velocity

Now that we have determined groundwater flow direction, we are in a position to ask how fast does groundwater flow? The parameters that are used in this

determination are **hydraulic conductivity**, porosity and **hydraulic gradient**.

Hydraulic Conductivity. Above, the concept of permeability and porosity were discussed. The size and degree in which the pore spaces are interconnected are important in determining the permeability of the aquifer. How easily a fluid can move through the aquifer depends upon the physical characteristics of the fluid. In terms of water, the potential for movement through the aquifer is described by the hydraulic conductivity (in units of distance/time, i.e. ft/sec, or [volume/day]/area, i.e. [gallons/day]/ft²). Typical values for the hydraulic conductivity (K) are given in Table 1 as a function of the type of aquifer.

Hydraulic Gradient. The slope of the potentiometric surface is an important contributor to the velocity of groundwater. The steeper the slope, the faster groundwater is likely to move. The gradient is measured as the change in elevation of the potentiometric surface over a given horizontal distance along a line perpendicular to the hydraulic head contours. For example, if the slope was 10

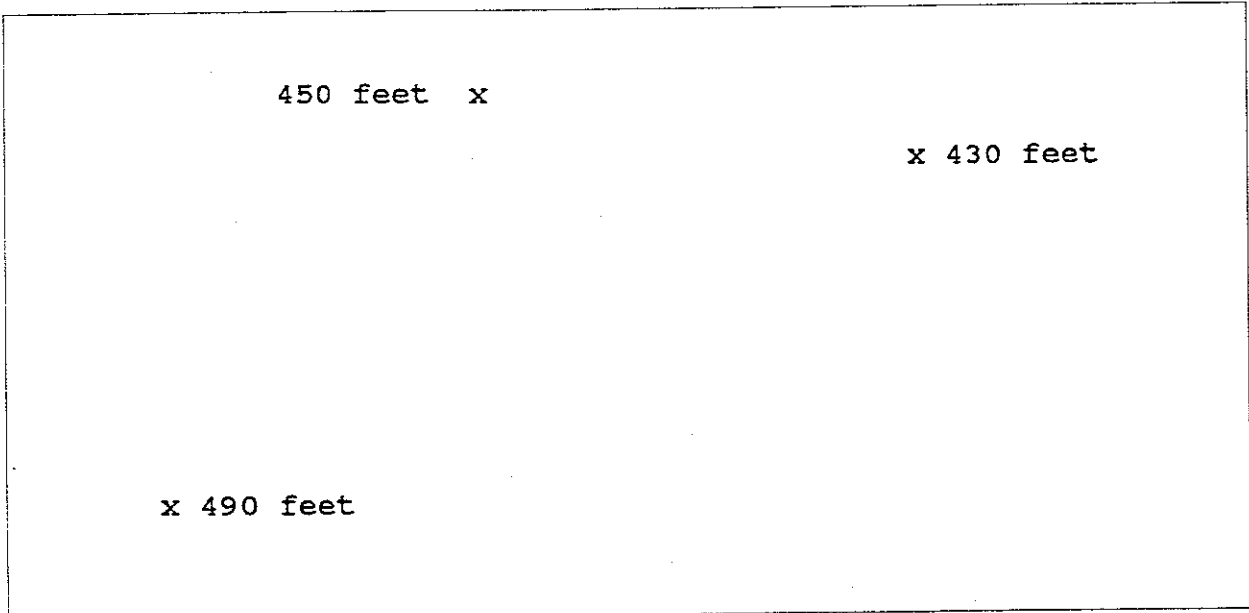

Exercise 5. Given the distribution of wells and elevations of static water levels, determine the approximate direction of groundwater flow using the three-point method.

feet per mile, the gradient would be $10/5280 = 0.0019$. Hydraulic gradients vary as a function of recharge/discharge, the permeability of the aquifer and the degree of confinement.

During periods of high recharge, such as prolonged rainfall or irrigation, groundwater may actually form a mound in a shallow unconfined aquifer as a result of the water being recharged at a rate that exceeds its ability to move laterally. During this period the gradient may steepen significantly.

In the vicinity of a high-volume well, the withdrawal produces a **drawdown cone** that may also produce a steeper gradient in the vicinity of the well (Fig. 10). The drawdown cone results during periods of discharge that exceed the ability of the aquifer to continuously supply the water from storage in the area immediately adjacent to the well. As a result, the hydraulic head is lowered in the vicinity of the well, increasing the gradient and increasing the flow rate of water from the aquifer to the well.

The drawdown cone will continue to grow until its size and the gradient are sufficient to supply water at a rate equal to the

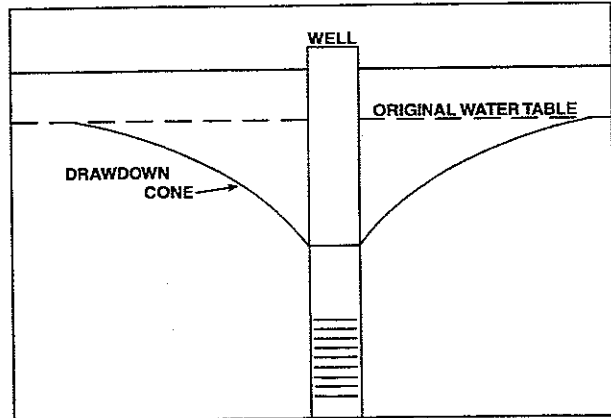

Figure 10. When a well is pumping, the water table is drawn down in the vicinity of the well as the aquifer supplies water to the well. This reduction of hydraulic head around the well can be referred to as the drawdown, the cone of depression, or the zone of influence. The extent of the drawdown cone will depend on the pumping rate, pumping duration and the aquifer characteristics. The drawdown can have a significant impact on the movement of groundwater in the immediate area around the well. The horizontal lines near the base of the well indicate the screened or perforated portion of the casing where water enters the well.

discharge rate. Because of the impact on hydraulic heads in the vicinity of a pumping well, the drawdown cone is often referred to as the **zone of influence**.

Recharge and discharge reach their respective peak levels at different times of the year (e.g. compare the rainy season with the time of greatest irrigation). As a result,

it is not uncommon to find that the hydraulic gradient may actually reverse directions at different times of the year.

Steep gradients are very difficult to maintain in unconfined aquifers with high hydraulic conductivities. It is common to find gradients less than 0.001 in regions underlain by **unconsolidated** sands and gravels. In contrast, gradients can be higher (> 0.01) in less permeable units. Gradients can be relatively high in confined systems regardless of the nature of the aquifer material.

Darcy's Law. The average velocity of groundwater (v_w) is related to hydraulic conductivity, porosity and gradient through an equation referred to as Darcy's Law.

$$v_w = [K/n] \times i$$

where K is the hydraulic conductivity, n is the effective porosity and i is the hydraulic gradient. The numerical value for i can be determined from a potentiometric map where the hydraulic heads (h) are contoured using the expression

$$i = [h_h - h_l]/L$$

where h_h is the higher head value, h_l is the lower head value and L is the distance between the two points along a path that is perpendicular to the head contours.

As an example, we will calculate the hydraulic gradient between points A and B on figure 7b. From the contours, we can estimate that the hydraulic head at A is 473 feet and 440 feet at B. The distance on the map between A and B is measured as 4.15 inches. Given the scale of one inch equals 3000 feet, this corresponds to a ground distance of 12450 feet. The gradient then is calculated as follows:

$$i = [473 - 440]/12450$$

$$i = 0.0027$$

If we assume that the aquifer depicted in figure 7b is a fine sand, the average groundwater velocity can be calculated by substituting the appropriate values into Darcy's Law equation.

From Table 1, we choose a porosity value of 0.4 and a hydraulic conductivity of 2.0×10^{-3} (i.e. 0.002) feet/sec.

Substituting we arrive at

$$v_w = [(0.002 \text{ f/s})/0.4] \times 0.0027$$

$$v_w = 0.000014 \text{ f/s} = 1.2 \text{ feet/day}$$

The actual velocity of groundwater can vary significantly depending on the nature of the aquifer, whether it is confined or unconfined, and the gradient. Velocities measured in tens of feet/day may occur in some cases.

Clearly the prediction of groundwater velocity requires very careful selection of the values to be utilized in the equation. In some cases, values of the hydraulic conductivity etc. are provided in various hydrogeologic reports from studies that have been performed in the area. Site-specific values for hydraulic conductivity are routinely obtained from aquifer tests designed to measure the water level response in an aquifer being stressed by controlled pumping. Information regarding aquifer tests is available from the Division or in "Oregon's Guidance to Wellhead Protection". Copies can be obtained by contacting the Division or the Department of Environmental Quality.

In most cases, however, values must be estimated, using values such as those in Table 1 for the appropriate geologic material as determined from geologic maps or well logs available for the area. If specific information is lacking, it is probably better to calculate the velocity as a range using maximum and minimum values.

Exercise 6. Assuming that for the map in exercise 4 the scale is one inch = 2000 feet, what is the gradient along a line that passes through point A? The aquifer is sand and gravel with a hydraulic conductivity of 0.001 feet/second and an effective porosity of 0.25. A gas station is located at point A and it is discovered that one of its underground storage tanks is leaking. Assuming that the contaminants move at the same velocity as the water, use Darcy's Law to estimate how long would it take the contaminated water to travel to a domestic well that is 200 feet directly downgradient?

Base Flow to Streams

If streams were only fed by precipitation, they would all be intermittent in their flow, only carrying water when it was raining. The fact that streams continue to flow during dry spells indicates that a portion of the discharge of the stream is supported by groundwater (Fig. 6). As indicated in the figure, groundwater moves downgradient and discharges to the stream through the banks and stream bed.

Streams that are fed by groundwater are referred to as gaining streams. In arid regions where the water table is deep, ephemeral streams are abundant. These are fed solely by precipitation and therefore flow intermittently. These streams actually serve as a recharge mechanism for groundwater in that water infiltrates through the porous material that makes up the stream bed. Such streams are referred to as losing streams.

Prolonged dry spells, which would progressively lower the water table, may significantly reduce the base flow to the stream. Additionally, if wells are installed upgradient from the stream these wells may actually intercept groundwater that is moving towards and supplying base flow to the stream.

Hydraulic Connection

Wells that are located in the vicinity of a surface body of water may actually derive part of their water from that surface water source. We can visualize how this happens by considering the progressive growth of the zone of influence. As the well continues to pump, the zone of influence (drawdown cone) continues to expand (Fig. 11). If the combination of aquifer parameters, pump rate and distance to the surface water body are appropriate, the zone of influence will eventually intersect the surface source. At that point, the well is extracting water from the surface water body.

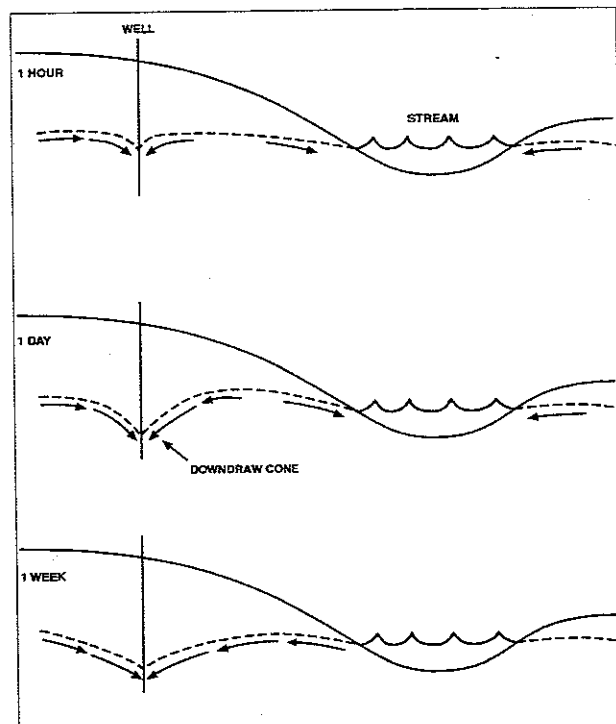

Figure 12. Expansion of drawdown cone (see Figure 10) as a function of duration of pumping. Limited duration pumping (upper figure) has little impact on the configuration of the potentiometric surface. As pumping continues, drawdown cone expands (middle figure) and may ultimately intersect the stream (lower figure). Note that in the lower figure, the pumping has reversed the gradient between the well and the stream resulting in the well drawing a portion of its water directly from the surface water source.

The amount of drawdown and its areal extent can be calculated assuming the hydraulic conductivity, thickness of the saturated zone and the storage coefficient, or the amount of water

released by the aquifer as the head drops, are known. The details of the equations and calculations are beyond the scope of this document. The interested reader is referred to any standard text in hydrogeology.

The recognition of hydraulic connection is particularly relevant to public water supplies in that it indicates that the system may be vulnerable to microorganisms such as *Giardia lamblia* or *Cryptosporidium*. Vulnerability to these organisms results in the system being declared under the direct influence of surface water.

The Oregon Health Division has established a protocol for making this determination. The first step is establishing, through either rigorous hydrogeologic assessment or prolonged gathering of water quality data, whether or not the system is in hydraulic connection with an established surface water source.

The hydrogeologic assessment involves determining such factors as the relation of the zone of influence and the surface water source, whether or not low permeability layers exist between the aquifer and the surface water, the vertical distance between the surface water body and the aquifer and projected travel times for water from the surface to the well.

The water quality assessment requires that at a minimum, the systems collect weekly

data on temperature and at least one other parameter, e.g. conductivity, pH or turbidity. This data must be collected from both the well and the surface water source.

Groundwater that is independent of surface water tends to show very little variation in the above parameters over time. Surface water commonly shows significant variations in these variables. If the surface water source and the well water are nearly identical throughout the period of observation it is clear evidence of hydraulic connection.

It is not uncommon, however, for hydraulically connected groundwater and surface water to differ chemically. This is because of a variety of chemical reactions that may occur within the unsaturated zone. However, if groundwater and surface water show similar, but not necessarily identical, variations with time it probably indicates that surface water is gaining access to the aquifer.

More detailed discussion of the hydraulic connection phenomenon and its relation to the determination of direct influence of surface water is provided in OHD's guidance document. Copies are available by contacting the Division. In terms of groundwater protection, water systems whose groundwater source is in hydraulic connection with surface water should realize that contaminants released to that surface water may ultimately be drawn into the aquifer.

Contamination of Groundwater

If we return to Figures 1 and 2, we recall that groundwater ultimately comes from precipitation and that precipitation reaches the aquifer by infiltrating downward from the surface. The question then is "What does water have to go through to reach the aquifer?". Figure 12 overlays the hydrologic cycle with an array of potential contaminant sources. From that combined perspective, it is clear how contamination of an aquifer could occur.

Whether or not a given aquifer will become contaminated depends on its vulnerability. Vulnerability consists of two conditions: contaminant presence and aquifer susceptibility.

It is evident that an aquifer would not be vulnerable to contamination unless the contaminant were present in the vicinity of

the well. Likewise, an aquifer would not be vulnerable to contamination unless that aquifer was susceptible to the contaminant. By this we mean is it possible that the contaminant could migrate from the surface or near surface to the aquifer.

Contaminant Sources

Contaminants that may affect groundwater are generally classed in one of three categories: microbiological (bacteria, viruses, *Giardia lamblia*, *Cryptosporidium*, etc.), inorganic chemicals (e.g. cadmium, chromium, mercury, lead, arsenic, selenium, cyanide, nitrate, radionuclides (e.g. radon and radium) and their decay products (e.g. alpha and beta particles)) and organic chemicals (e.g. pesticides and solvents).

Potential contaminant sources (PCS) vary from major industries to individual

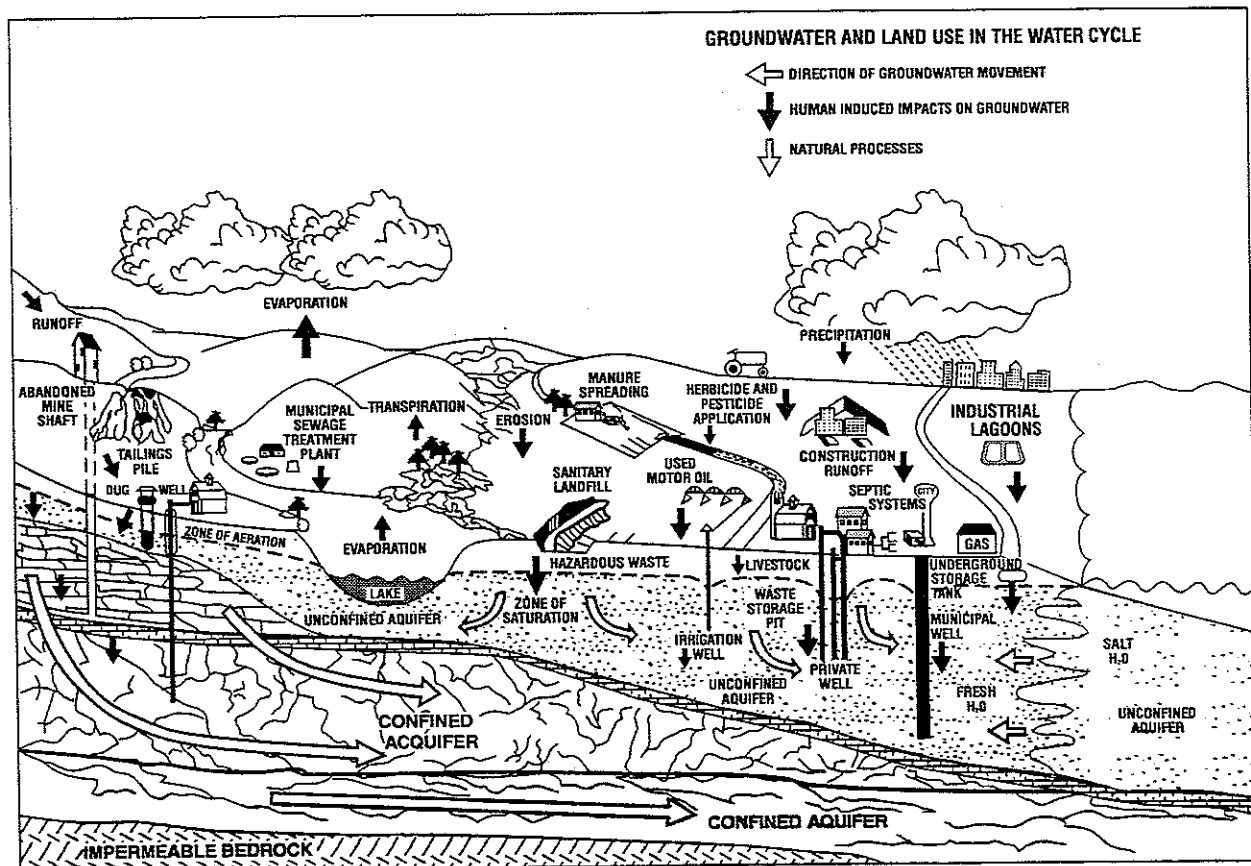

Figure 12. This figure depicts the varied activities that may go on at the surface as a function of land use. All of these activities are associated with potential groundwater contaminants. When viewed from the perspective of the hydrologic cycle (Figure 1), which indicates that groundwater is recharged by infiltrating precipitation from the surface, it is apparent that activities at the surface could contribute contaminants to the infiltrating water and eventually contaminate the aquifer.

residences. Although we tend to think of groundwater contamination as resulting from a release from a major source, it is important to realize that only a small amount of contaminant introduced to the aquifer can significantly impact groundwater quality.

As an example, trichloroethylene (TCE), the most common organic contaminant in the U.S., is a constituent in many common household products. If one liter of TCE were uniformly mixed throughout an aquifer, that single liter could contaminate over 280,000,000 liters of water to the 0.005 mg/L MCL for this compound. As a result, we must consider the potential impact of even small PCSs to the aquifer.

It is convenient to consider contaminant sources as falling in one of two general categories: point and nonpoint sources. Point sources are those in which a release is associated with a specific site. Examples would be unlined landfills, contaminant spills, leaking lagoons or tanks, illegal dumping, confined animal feeding operations, etc.

Nonpoint source contamination refers to a more widespread introduction of contaminants, often associated with a specific practice, but not at a specific site. Examples include septic systems in areas of high-density housing, application of agricultural chemicals, application of municipal sludge, storm water drains, etc.

Point sources tend to produce a well-defined zone of contamination called a **plume**, a region in the aquifer characterized by detectable contaminants. A plume is surrounded by groundwater in which the contaminant cannot be detected. Generally, point source contamination affects only a few wells and concentrations can vary significantly between them. Plumes are often elongated in the direction of groundwater flow, however the actual shape is a function of both the aquifer characteristics and the contaminant's chemical properties.

In contrast to the localized character of point source contamination, nonpoint sources tend to produce elevated concentrations of the contaminant(s) over a wider area. Typically, many wells will be affected in the area and concentrations will be relatively uniform.

Movement of Contaminants in Groundwater

In an area where groundwater contamination has occurred, involving more than one contaminant, it is not uncommon to find that the contaminants are moving at different velocities than the water and often from each other. The velocity at which a given contaminant moves depends on the nature of the aquifer, the hydraulic gradient and the properties of the contaminant itself.

Aquifer Characteristics. Important characteristics of the aquifer include both its makeup and its physical character, e.g. is it fractured or granular, how much of it consists of clay minerals or organic matter and how permeable is it? Clearly the direction and steepness of the gradient is also going to control both direction and velocity of contaminant migration.

Contaminant Characteristics. Important chemical properties that influence contaminant migration include the **solubility** of the contaminant, the contaminants tendency to attach itself to aquifer constituents and how long the contaminant survives before breaking down into another, hopefully less toxic component.

The more soluble a contaminant is in water, the more widespread will be its distribution over time. The more likely it is that a contaminant will undergo **sorption** (i.e. become attached to) onto either clay minerals or organic matter, the more the contaminant will be **retarded** relative to groundwater movement and the more limited will be the contaminant's distribution.

A contaminant may be degraded naturally by both inorganic and organic processes. Some contaminants break down when they are

exposed to the sun, others are transformed by biological reactions when microbes use them in their metabolic processes. Still others undergo hydrolysis, reacting with the water to change to a different molecule. Because of the transformations, it is possible that a single contaminant can give rise to a plume that contains several additional compounds. For example, tetrachloroethylene's (PCE) breakdown products include trichloroethylene (TCE), 1,1-dichloroethylene (1,1-DCE) and vinyl chloride. Each of these contaminants have differing solubilities and sorption characteristics, leading to a potentially complex distribution of chemicals within the plume.

The tendency for contaminant degradation is expressed as its **half-life**, the time it takes the amount of the contaminant present to be reduced by 50 percent. If the concentration of a given contaminant were initially 100 parts per billion, after one half-life the concentration would be 50 ppb, after two half-lives it would be 25 ppb, etc.

The half-lives of contaminants vary from less than a day to years. Clearly, the longer the half-life, the more of a threat a contaminant poses to groundwater. Contaminants that have a combination of a long half-life and a low sorption potential will be considerably more widespread than a contaminant with a short half-life and a high sorption tendency.

Examples of sorption characteristics and half-lives of some common contaminants are provided in the "Guidance Document for Phase II/V Use and Susceptibility Waiver Application" distributed by the Division.

Persistence of Contaminants in Aquifers

It is important to realize that once contaminants enter the unsaturated zone or the aquifer itself, they may remain there continuing to impact groundwater for long periods of time. Many of the contaminants that we are concerned with are organic liquids, e.g. solvents, lubricants and fuels,

most of which are immiscible with water, i.e., they will not mix with water.

Nonaqueous Phase Liquids (NAPLs).

Collectively these contaminants are referred to as nonaqueous phase liquids (NAPLs). If a NAPL is released in the unsaturated zone, e.g. by a spill, illegal discharge or leaking storage tank, it will contaminate a certain volume of the soil and underlying geologic materials, the volume depending on the amount and rate of the release.

It is known that as a NAPL moves downward through the soil, etc. it leaves behind a portion of the chemical in the soil at what is called residual saturation. The contaminant at residual saturation is essentially immobile, it will not continue to migrate downward as a NAPL. However, each time infiltrating precipitation or irrigation water moves through the contaminated material, a certain amount of the NAPL will dissolve in the water and be transported downward (Fig. 13). By this mechanism, a "small" release near the surface can impact groundwater that is much deeper than the apparent extent of contaminated soil.

If the release is large enough or occurs over a long period of time, the contaminant may reach the aquifer directly. Petroleum products, being less dense than water may float on top of the water table (Fig. 13). These products are referred to as light-, or low density, NAPLs or LNAPLs. Gasoline falls in this category.

A release of gasoline from an underground storage tank may be such that the gasoline reaches the aquifer as a liquid. A lense of gas will float on top of the water table and will move up and down as the water table moves up and down. By this process, a larger volume of the unsaturated zone and the aquifer become contaminated to residual saturation.

The gasoline will also dissolve in the groundwater contributing a wide array of organic chemicals to groundwater, including the BTEX components (*Benzene, Toluene,*

Ethylbenzene and the *Xylenes*). Vapors from the gas can move throughout the unsaturated zone creating an even larger contaminated area. These vapors can be "captured" by infiltrating water and carried to the aquifer.

Solvents are referred to as dense NAPLs, or DNAPLs. They are more dense than water and will move through the aquifer if the quantity of the release is sufficient (Fig. 13). As the DNAPL migrates through the unsaturated and saturated zones, it leaves behind a trail of DNAPL at residual saturation that will continue to yield contaminants to water that may pass through it. DNAPLs will continue to migrate downward and if the released quantity is

sufficient, may actually pool, i.e. saturate the aquifer, at the base of the aquifer.

Because of the residual saturation occurrence, NAPLs are extremely difficult to remove from the aquifer. Even if the free product is removed, assuming that it can be located, there will still remain a source of groundwater contaminant in the aquifer or unsaturated zone.

Groundwater Protection

It is widely recognized that prevention of contamination is much more cost effective than cleaning up a contaminated site or treating contaminated groundwater. The examples listed in the introduction indicate that the tangible and nontangible costs may

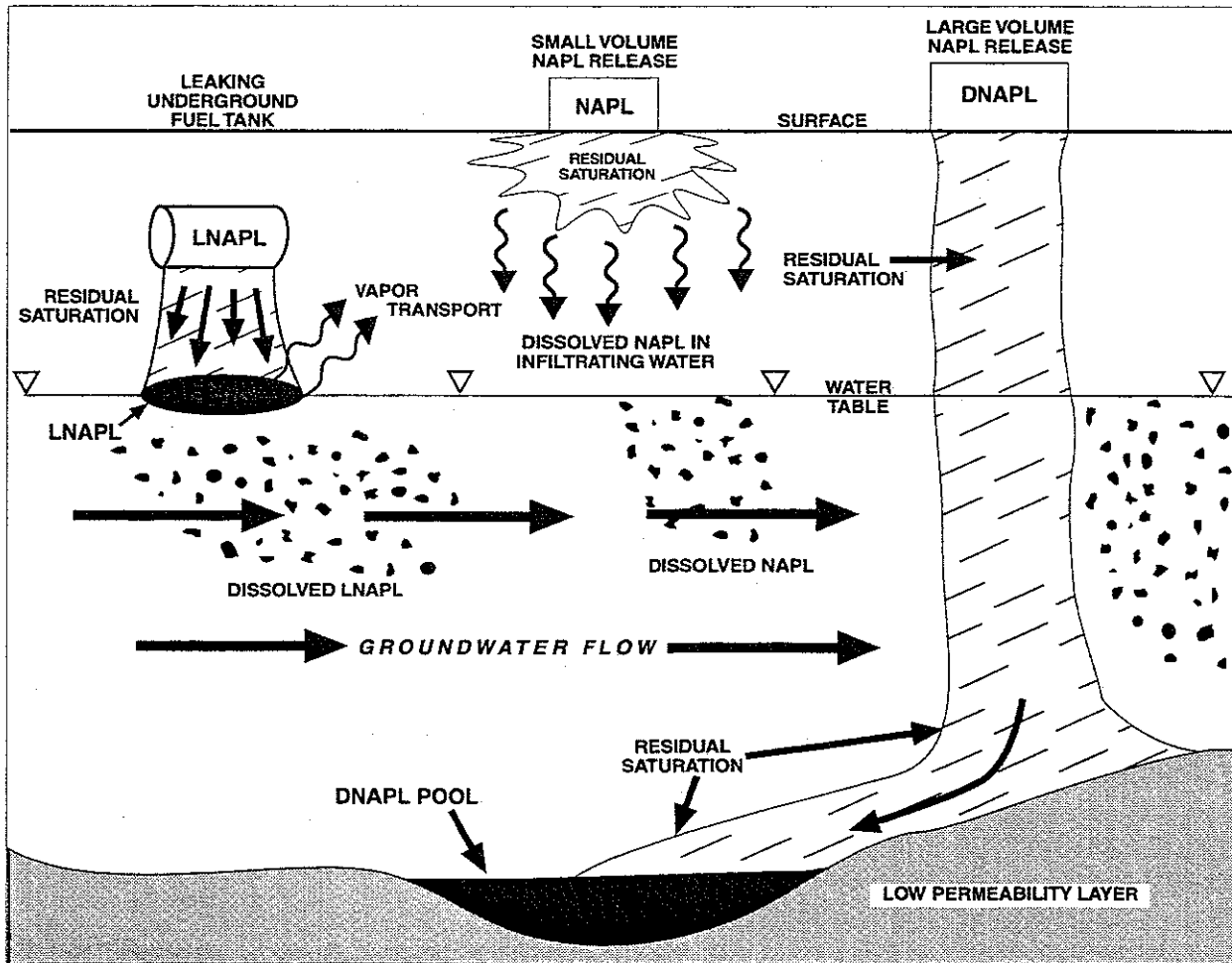

Figure 13. The potential impact of releases of nonaqueous phase liquids (NAPLs) on groundwater. Low density NAPLs (LNAPLs) such as petroleum products will float on the water table whereas high-density NAPLs (DNAPLs) such as solvents will sink through the aquifer if the volume of the release is sufficient. As NAPLs migrate through the unsaturated and saturated zones, they leave behind a "trail" of relatively immobile contaminant at residual saturation. Removal of the NAPL at residual saturation is very difficult. Both free product and the contaminant at residual saturation can contribute dissolved contaminants to groundwater. Vapor transport within the unsaturated zone of the more volatile NAPLs is also possible. Groundwater flow direction is indicated by the arrows.

be considerable if a drinking water source becomes contaminated.

Wellhead Protection

The 1986 amendments to the Safe Drinking Water Act require that states develop plans aimed at protecting the groundwater that supplies drinking water to public water systems. The EPA has referred to this program as Wellhead Protection.

Oregon has developed a voluntary Wellhead Protection program (WHP) that consists of a number of steps designed to minimize the risk of contaminants reaching the drinking water source. Three main elements comprise Oregon's WHP: delineation of the critical area to protect, inventory the potential contaminants within that area, and development of a management strategy designed to minimize the potential of those sources contaminating the aquifer.

An integral part of the program is public education and public involvement. Often, the general public does not understand the relation between surface activities and groundwater contamination. They do not understand that the source of groundwater is downward percolating precipitation (Fig. 1). When you couple that process with the diversity of land uses that take place nowadays (Fig. 12) it is apparent that groundwater is vulnerable to degradation as a result of surface activities.

The recycling bill in Oregon clearly indicates that once a sound environmental practice is explained to the general population, they respond accordingly. Our experience is that if the vulnerability of groundwater to surface activities is explained, people change their practices in a manner that is protective of the resource. The fact that groundwater supplies the water they drink and cook with makes the rationale behind protecting the aquifers even more evident.

Public involvement is also critical to the development of a WHP plan. Wellhead protection plans are not developed and

implemented solely by the water system. The development and oversight of the plan is a community responsibility. The management plan developed may impact the way in which a certain segment of the community routinely does things. If these individuals are brought "on-board" early in the development of the plan, they are more likely to be part of the solution than if the plan is suddenly, and without much explanation, dropped on their doorsteps.

The management activities will almost always fall outside the area owned by the system and will require the support of the community that is supplied by the system. As a result, the WHP plan will be developed by a Committee that consists of representatives from all interested and potentially affected individuals and groups.

Below Oregon's WHP program is briefly described. Readers are referred to the "Oregon Guidance to Wellhead Protection", available from the Division or the Department of Environmental Quality, for further information regarding Oregon's program.

Delineation of the Wellhead Protection Area

The wellhead protection area (WHPA) is that area that directly overlies that part of the aquifer that contributes water to a well or spring (Fig. 14). It is within this area that if a contaminant is released it may move or be carried downward to the aquifer and eventually move with groundwater to the well. Based on the text above, it should be evident that the size, shape and orientation of the WHPA will be dependent on several factors: the pump rate, the hydraulic gradient, and the characteristics of the aquifer. As a result, the delineation of the WHPA should be based on site-specific data.

Oregon has identified three basic methods for delineating WHPAs for public water systems: calculated fixed radius method, analytical methods with hydrogeologic mapping, and numerical methods. For all

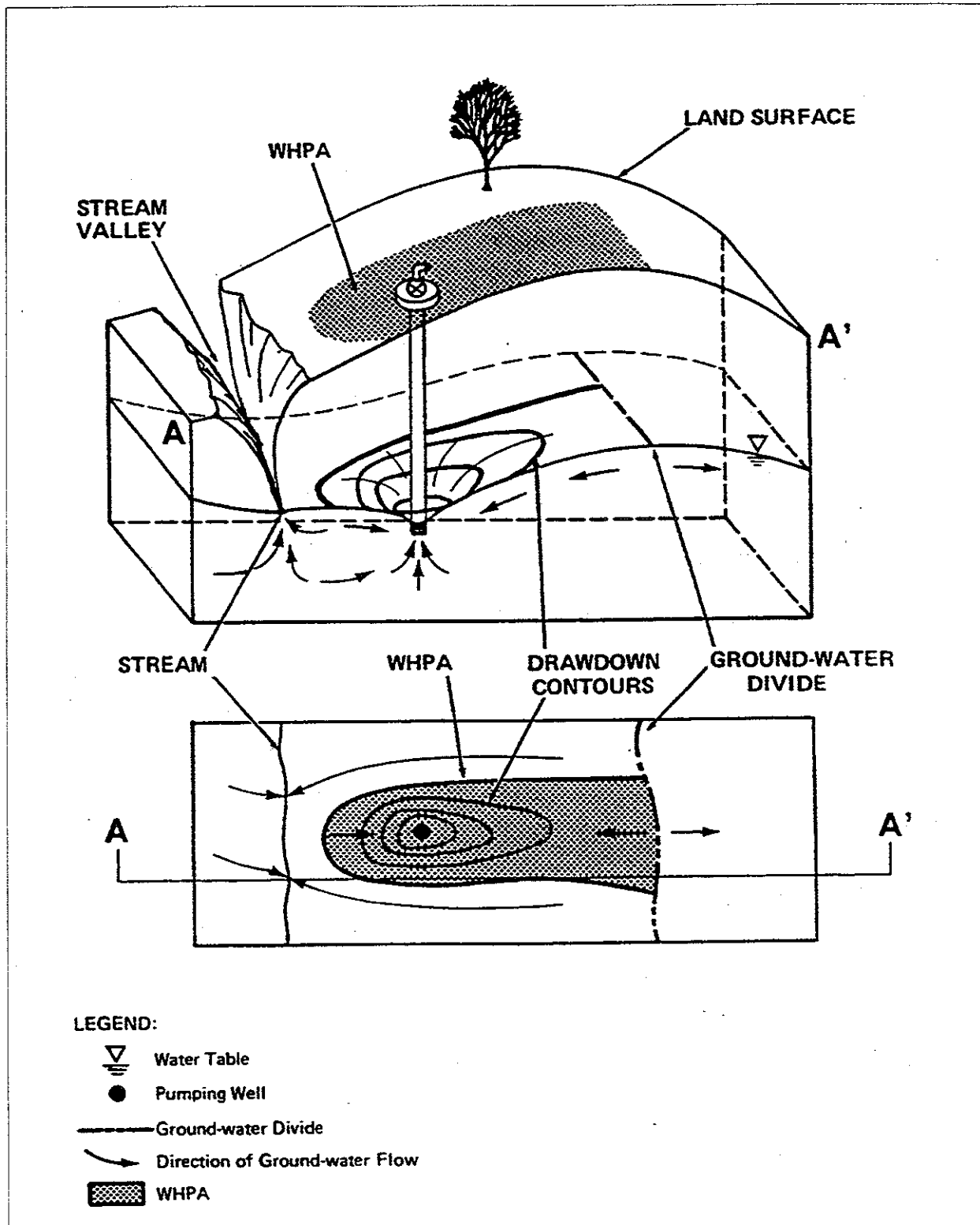

Figure 14. Diagram illustrating the relationship between the wellhead protection area (WHPA) and the capture zone of the well. In the upper diagram the effect of the pumping well on the regional water table can be seen. The drawdown cone perturbs the direction of groundwater flow in the well's proximity creating a capture zone. Any water molecule, and any dissolved constituent, within the boundaries of the capture zone will ultimately travel to the well. The WHPA represents the land area directly above the capture zone. Any contaminant released within the WHPA could migrate to the water table and follow the groundwater flow within the capture zone to the well. The WHPA is the region where groundwater protection strategies should be focussed.

three methods, the extent of the WHPA is designed to identify the aquifer that will supply groundwater over a 10-year time-of-travel (TOT), i.e. it takes 10 years for the groundwater to move from the boundary to the well.

Calculated Fixed Radius. The calculated fixed radius method is acceptable only for small (population <500) systems. The method only requires input regarding the pump rate, the effective porosity and the screened interval or thickness of the water-bearing zone(s) in the well. The method does not take into account the hydraulic gradient and therefore the natural movement of groundwater in the area.

All systems serving a population of 500 or more will develop a conceptual model regarding groundwater in the area: what are the aquifers and their characteristics, what is the gradient, what hydrologic boundaries occur in the area and what is the recharge (i.e. precipitation/irrigation) and discharge (wells, springs, base flow) in the area? The conceptual model provides a "view" of the groundwater system and allows for a more representative delineation.

Analytical Methods. Analytical methods with hydrogeologic mapping make use of the conceptual model and consider the aquifer's characteristics, e.g. hydraulic conductivity and gradient. In addition to identifying aquifer characteristics, hydrogeologic mapping incorporates hydrogeologic boundaries such as rivers and edges of the aquifer into the delineation.

As with the calculated fixed radius technique, the analytical methods make use of equations that describe the relation of groundwater flow to the various parameters listed above. [Somewhat analogous to the equation distance = velocity x time, which describes the relation between distance travelled by an object and its velocity and how long it has been moving]. When the proper values for the hydraulic

characteristics are put into the equations, the boundary of the WHPA is provided.

Numerical Methods. One of the limitations of most of the analytical methods is that the equations assume that the aquifer is homogeneous. Anyone who has looked at the sediments in a stream bank will quickly realize such an assumption is a great oversimplification. Numerical methods allow for a more precise characterization of the aquifer and allow for calibration of the model once it is developed. The resulting WHPA is a much better representation of the critical area deserving protection than any of the previous methods.

Although the expense of the delineations increase significantly from calculated fixed radius through the analytical and numerical methods, the delineation resulting from the more sophisticated methods is more defensible and the community can have greater confidence in the boundaries indicated. Further, it has been discovered that in many cases the size of the WHPA decreases as one employs the more technical tools. This has significant implications for the management part of WHP in that it is easier, and less expensive, to manage a small area than a large area.

Inventory of Potential Contaminants

Once the WHPA is delineated, an inventory of potential contaminant sources is conducted within the boundary of that area. Although we traditionally think of "big industry" when we think of sources of contaminants, it should be understood that contamination can occur as the result of a wide range of activities, some of which occur in individual homes.

The inventory does not necessarily involve going to individual homes and businesses and physically determining what potential contaminants are there. Rather, we know from experience the types of potential contaminants that are associated with a given type of activity, whether it is residential areas on septic systems, gasoline

stations, dry cleaners, metal refinishers, etc. We can assume that if a particular activity occurs within the wellhead protection area, that the associated contaminants occur as well.

The inventory should list the potential sources that occur and should include a map showing their distribution. Details of the recommended inventory process are available in "Oregon's Guidance to Wellhead Protection", available from the Division or the Department of Environmental Quality.

Management Strategies within a Wellhead Protection Area

Management plans within a wellhead protection area should be designed to *minimize* the potential impact of specific activities on groundwater quality. Management approaches vary from nonregulatory, e.g. public education and hazardous waste collection, to regulatory steps such as special permitting, zoning ordinances and engineering upgrades.

The management plan is developed by the local community through a committee that represents the diverse interests in the community. Recommendations regarding management strategies are provided in "Oregon's Guidance to Wellhead Protection", available from the Division or the Department of Environmental Quality.

Wellhead protection is an ongoing project. Periodic updating of the inventory and management strategies is required to keep the plan current with the community's overall needs and resources.

Communities that are interested in obtaining a state-approved wellhead protection plan should contact either the Division or the Department of Environmental Quality's Groundwater Section. The state agencies in conjunction with Citizen Advisory Committees, developed an approach to wellhead protection that will, if followed, provide a real measure of protection for groundwater that supplies drinking water through a public water system.

Additional information regarding wellhead protection plans for communities can be obtained from the EPA document EPA/625/R-93/002 "Wellhead Protection: A Guide for Small Communities" available through the Safe Drinking Water Hotline (1-800-426-4791).

Well Construction

Wells provide a means by which groundwater from the aquifer can be brought to the surface for use as drinking water, irrigation water, etc. Importantly, if they are not constructed properly, wells can also provide access to the aquifer of contaminants from the surface or near surface.

The Oregon Water Resources Department (WRD) has authority in the state to regulate the construction of water wells. When a well is drilled, WRD's rules require that it be done by a licensed well constructor. WRD recognizes that public water systems may have special construction needs and acknowledges that the Health Division may have additional requirements for the construction of such wells. Of particular concern here is the construction of the casing seal in the upper portion of the well.

Casing Seal

When the well is drilled, WRD requires that the upper hole be oversized by at least 4 inches, e.g. if a 10 inch hole is desired, the upper hole must be oversized to 14 inches. After the oversizing is completed, the finished hole casing (10 inches in diameter in this example) is placed in the hole, and the annular space between the casing and the oversized hole is filled with appropriate sealing material (see WRD's rule 610-210-310 to 330).

This seal is referred to as the casing seal and has the purpose of preventing shallow potentially contaminated water from gaining access to the casing and migrating down to the aquifer. WRD's rules specify that the depth of the casing seal be at least 18 feet, *but in all cases the actual depth*

must be controlled by the subsurface geology. Specifically, the seal must extend at least 5 feet into confining layers or bedrock if present. If no confining layer or bedrock is present, WRD rules stipulate that the casing extend at least 5 feet below the water table.

The Health Division asks during the planning phase of a new well that the water system submit to the Division copies of well reports (obtainable from local watermaster's office) from the area. OHD will utilize these well reports in order to make recommendations regarding the placement of the casing seal. The Division will work with the well constructor to obtain the appropriate seal depth.

The benefits of a properly constructed well are numerous. Some of these were discussed in the Summer 1994 issue of the PIPELINE (OHD's Newsletter). In several cases, additional costs in treatment and/or monitoring could have been or actually were averted as a result of proper well construction.

Aquifer Commingling

The term commingling implies that a given well is open to more than one aquifer. For example, a single well that is perforated in both an unconfined and a confined aquifer. Oregon law prohibits such wells. The reason being that if the more vulnerable unconfined well becomes contaminated, the contaminants could potentially spread to the lower confined aquifer.

It should be noted that many aquifers have multiple water-bearing zones and that Oregon law does not prohibit deriving waters from different levels *as long as they are in the same aquifer*. So how do we determine if two separate water-bearing zones are in the same aquifer or in different aquifers? This is not an easy question to answer, however there are several indicators that can be used.

Lithology. When examining well logs there are several lithologic indicators that might

indicate separate aquifers are being evaluated. For example, if the well log indicates that the geology consists of unconsolidated alluvial sediments above consolidated bedrock, e.g. basalt, sandstone, siltstone, shale, granite, etc., the unconsolidated material probably is a separate aquifer from the consolidated material.

A second lithologic indicator of more than one aquifer would be the presence of a thick persistent confining layer in a sequence of unconsolidated alluvial sediments. For example, if the log indicated that the upper 100 feet of sands, gravels and clay beds were separated from similar sediments at depth by a 20 foot thick clay layer that other well reports demonstrated to be extensive throughout the area, it is likely that two alluvial aquifers are present.

Hydraulic Head. The value of the hydraulic head in separate water-bearing zones may provide information regarding whether more than one aquifer is present. If there is a significant difference in the head values between two water-bearing zones in the same well, it is likely that two separate aquifers are involved.

Care must be taken when determining the head values. The well cannot be open to both water-bearing zones when the heads are measured because the resulting head will be a composite. Further, the well must be allowed to be at rest for a sufficient period in order for the static water level to be representative of the actual head value.

Water Chemistry. The composition of groundwater is a function of the original source of the water, the types of reactions between the aquifer and the water, and the length of time that the water has been in contact with the aquifer (residence time). In most cases, the groundwater in separate aquifers have undergone significantly different histories in terms of the above items. Consequently, if waters from two separate water-bearing zones exhibit significantly different compositions, it is

likely that two aquifers are present. Samples can be analyzed for the common ions to determine the specific composition of the water.

As with the measurement of hydraulic heads, the sampling for chemical analysis must be done in such a way that each water-bearing zone is sampled independently. A quick field indicator of water chemistry is the conductivity or specific conductance of the water, a measure of the concentration of dissolved ions in the water. If the water-bearing zones have significantly different specific conductances, it is likely that two or more aquifers are involved.

Water Rights

In Oregon, water is publicly owned. With some exceptions, users must obtain a water right in order to use water from any source. This applies to public water systems as well. Wells utilized to irrigate 0.5 acres or more, industrial or commercial wells that use in excess of 5000 gallons per day, or single or group domestic wells that use 15,000 or more gallons per day are required to have a water right. Specific information can be obtained from the local watermaster's office.

Useful Data for Public Water Systems to Collect

There are several routine measurements that water systems should collect in order to build a data base that pertains to their water system. These include a well log inventory, static water levels, pumping rates, an aquifer test and common ion water chemistry. The data derived is very useful should the system want to evaluate the impacts on changes in production levels, if a contaminant is found during routine monitoring, or if the system decides to initiate a wellhead protection plan.

As an example, a water system that has complied with the routine monitoring schedule for inorganics, VOCs, SOCs, etc. may suddenly find a contaminant in the water. Deciding the significance of that occurrence and developing a plan to deal

with it is very difficult without the benefit of additional data regarding the nature of the groundwater system in the past. The data below provides some of that basic information.

Well Log Inventory

A well log inventory consists of a compilation of well reports from wells (irrigation, domestic, etc.) in the vicinity of the system's production well(s). These well reports can be obtained from the local watermaster's office. They should be from the section that the production well is in and the neighboring sections. The reports should be plotted on a map of suitable scale.

The utility of the well log inventory is that it gives the system a better picture of water use in the area. The inventory also provides the basis for developing a conceptual model that will identify aquifer units, confining layers, etc.

Static Water Levels

The routine determination of SWLs in the water systems wells provide the basis determining long-term trends in water levels and help to clarify the nature of the aquifer. Ideally, SWLs should only be determined if the well has been at rest for a minimum of 24 hours.

Pumping rates

Water systems should have a means of evaluating their water usage. This provides basic information regarding the management of their resource. Water usage monitoring is important in developing groundwater protection strategies as well as identifying leaks within the system. This data is important in developing long term management plans.

Aquifer Test

An **aquifer test** consists of a controlled constant-rate pumping test. The product of this test is a better understanding of the aquifer's characteristics, particularly the hydraulic conductivity which allows for the prediction of rate of groundwater (and contaminant in some cases) movement. This

data is fundamental to developing a wellhead protection plan. Procedures for a constant-rate pump test are available from the Health Division.

Common Ion Chemistry

Water systems are required to monitor water quality on a routine basis for specific potential contaminants. It is also important to periodically monitor the water for the **common ions**, many of which are included

in the list of secondary (non-enforceable) contaminants. These components are reflective of the groundwater's history in the aquifer. Significant changes in common ion chemistry may indicate a change in the conditions that are affecting the source of your drinking water. Further, the chemistry of your groundwater may be useful in developing the conceptual model of the groundwater system in the area.

Glossary

Alluvium. Sediments deposited by a stream or river. Normally these consist of sands, gravels, silts and clays.

Annular Seal. See **Casing Seal**.

Annular Space. The space between the casing and the outer wall of the drill hole.

Aquiclude. Any impermeable geologic material in the subsurface through which groundwater flow is minimal to nonexistent. Examples include clay and unfractured igneous rocks. See **Confining Layer**.

Aquifer. Any geologic material in the subsurface that is saturated with water and will yield that water to a well. Coarse-grained alluvial sediments (e.g. gravels) or highly fractured bedrock (e.g. sandstones, granites, basalts) make good aquifers.

Aquifer Test. A test of the water level response in an aquifer that is being stressed by continuous pumping at a constant rate. The level of the water in the production well and in monitoring wells in the same aquifer is a function of the pump rate, the time since pumping began, the distance from the production well, the aquifer's characteristics and the hydrogeologic setting.

Aquitard. An geologic material of low permeability in the subsurface that transmits water very slowly, e.g. a dense lava flow, volcanic ash, shale or clay. See **Confining Layer**.

Artesian. Generally a characteristic of confined aquifers. Artesian indicates that the elevation of the static water level in a well is greater than the elevation of the aquifer, i.e. the water rises in the well above where the water-bearing zone is encountered. If the water reaches the surface it is referred to as a flowing artesian well.

Basalt. A fine-grained igneous rock formed by crystallization from a molten state. Basalts consist of the minerals pyroxene and plagioclase and solidified at or very near the earth's surface. They are common volcanic rocks in Oregon.

Base Flow. Water supplied to a stream by groundwater.

Casing Seal. A seal that is placed in the annular space of the upper part of the well to prevent access to the casing of surface and near surface waters. The annular space must be at least two inches in width. Specific types of grout must be placed in the annular space.

Coarse-grained. Term applied to rocks in which the individual minerals can be readily seen with the unaided eye.

Common Ions. Dissolved constituents that are commonly found in all groundwater, including calcium, sodium, magnesium, potassium, chloride and sulfate. Their relative abundances often reflect the aquifer from which they were derived and the history of the water itself.

Conceptual Model. A three dimensional picture of the groundwater system, identifying the aquifers, their properties and boundaries, the direction of groundwater movement and areas of recharge and discharge.

Conductivity. A measure of the ability of the water to conduct a current. A function of the concentrations of dissolved ions. The higher their concentration, the higher the conductivity.

Cone of depression. See **Zone of Influence**.

Confined aquifer. An aquifer that is separated from the surface by a confining layer. Recharge to confined aquifers may be at a point some distance from the well.

Confining layers. Layers of low permeability that constrain groundwater to move within particular regions in the subsurface. Water cannot readily move through a confining layer.

Consolidated. As applied to geologic materials, the term implies that the material is solid throughout as opposed to comprising loose materials. These are materials that have either been cemented or in which the individual minerals grew together at formation. Examples of consolidated materials includes cemented sediments such as sandstone and conglomerate, non-weathered igneous rocks such as basalt, andesite and granite.

Delineate. The process of determining the boundaries of a specific area. Used here with reference to the wellhead protection area.

Discharge. Areas or points where groundwater leaves the aquifer. Discharge areas can be natural such as supplying base flow to streams or discharging to lakes or springs, or discharge can be artificial through wells.

Dissolved. The condition when a particular solid or liquid breaks down to the molecular or atomic scale in water. Dissolved constituents are not influenced by gravity and cannot generally be seen.

DNAPL. A nonaqueous phase liquid that is more dense than water, e.g. a solvent.

Drawdown cone. See **Zone of Influence**.

Elevation head. The potential energy that water has as a function of its elevation.

Fine-grained. Term applied to rocks in which the individual minerals cannot be seen with the unaided eye.

Granite. A coarse-grained igneous rock formed by crystallization from a molten state. Granites consist primarily of quartz and feldspar and solidified below the earth's surface. They are exposed today because of erosion.

Groundwater. Water that occurs within the saturated zone below the surface.

Grout Seal. See **Casing Seal**.

Half-Life. The time it takes for a substance to transform to another substance by any reaction so that the initial concentration is reduced by 50%. If a contaminant with a half-life of 60 days is originally present at 100 mg/L, after 60 days its concentration will be 50 mg/L, after 120 days the concentration will be 25 mg/L, 12.5 mg/L after 180 days, etc.

Hydraulic conductivity. The permeability of materials with respect to water. Generally expressed as distance/time, e.g. feet/day, or as volume/area/day, e.g. gallons/ft²/day). High hydraulic conductivity implies a high permeability with respect to water.

Hydraulic gradient. The change in hydraulic head over distance in the direction of groundwater flow. For example the hydraulic gradient in an area where the hydraulic head drops 10 feet in one mile is 0.0019. Note that the gradient does not possess any units, i.e. is dimensionless.

Hydraulic head. The potential energy possessed by water at a given point as a function of its elevation (elevation head) and the weight of water above it (pressure head). Often expressed as the elevation of the static water level. Within an aquifer, water will move from a region where the groundwater possesses higher hydraulic head to a position where the groundwater possess lower hydraulic head.

Hydrologic boundary. The boundary of a hydrologic unit. For an aquifer a boundary may be considered a constant head (e.g. a stream or other perennial surface water source) or a no-flow boundary (e.g. a geologic contact with an impermeable unit, a groundwater divide or a fault across which water flow is restricted).

Hydrologic Cycle. The process by which water is distributed across the planet. The sun evaporates water off of the sea surface which is carried by the winds over the continents. Water falls as precipitation whereupon it may be utilized by plants and animals, may collect as surface water or may infiltrate to recharge groundwater. Eventually, the water returns to the ocean, primarily by surface water flow, to complete the cycle.

Hydrologic setting. The framework that controls or influences the occurrence and movement of groundwater in an area. Includes the character of the hydrologic units, their depth and distribution, relevant geologic structures, areas of recharge and discharge, and hydrologic boundaries.

Hydrologic units. Geologic units, having thickness and area extent that influence the movement of groundwater. Hydrologic units may be aquifers, aquitards or aquicludes.

Immiscible. Applied here to liquids that will not mix, e.g. oil and water. Immiscible liquids can still dissolve within one another, e.g. when gasoline and water are brought together they remain as separate liquids, i.e. do not mix, however, some of the gas will dissolve in water and some of the water will dissolve in the gas.

Infiltrate. Used here to describe the downward movement of water from the surface through the individual grains and fractures in the soil and underlying geologic materials.

Interflow. The predominantly lateral movement of water within the unsaturated zone. This may be controlled by local variations in the permeability and often leads to seeps or ephemeral springs.

Ion. A dissolved chemical that possesses a charge. Positively charged ions are cations, negatively charged ions are anions. A common form of occurrence for dissolved constituents. Collectively dissolved ions give the water a specific value for conductivity.

Lithology. Refers to the specific type of rock or sediment, as in "The lithology consisted of sands and gravels".

LNAPL. A nonaqueous phase liquid that is less dense than water, e.g. gasoline and oil.

NAPL. See **Nonaqueous Phase Liquids.**

Nonaqueous Phase Liquids. Liquids that are immiscible in water, i.e. do not mix with water, e.g. gasoline, solvents, oil, etc.

Perched Aquifer. A short-term saturated zone that exists above a local impermeable layer. Formed during periods of high infiltration that is briefly detained by the impermeable zone. Generally will not produce significant water throughout the year.

Permeability. The capacity of a substance to transmit a liquid. A substance with high permeability will allow a liquid to readily move through it.

Plume. The volume of the aquifer where a contaminant occurs in groundwater. A plume is generally associated with a point source and is elongated in the direction of groundwater flow.

Pore spaces. Open spaces in an otherwise solid substance. In geologic materials pore spaces may be the regions between individual grains or the open spaces associated with cracks or other fractures in the material.

Porosity. The fraction of the material that is open space. For example, if a sand has a porosity of 0.25, it implies that 25 percent of the volume occupied by the sand actually consists of open space.

Potentiometric surface. The surface showing the distribution of hydraulic head for an aquifer. Although routinely applied to confined aquifers, can be used in place of water table for unconfined aquifers.

Pressure head. The potential energy that water possess as a result of the weight of the water above it in the aquifer.

Recharge. The addition of water to the aquifer through infiltration of precipitation or irrigation water from the surface.

Recharge Area. The area on the surface that overlies the aquifer where infiltrating water recharges the aquifer.

Residence Time. The duration of time that groundwater is in contact with the solid materials that make up the aquifer. Because the water reacts with these solids, the composition of the water is often a function of the residence time.

Retardation. Applied to contaminant movement where the contaminant does not move at the same velocity as groundwater because the contaminant is reacting with the solids in the aquifer.

Saturated zone. Zone below the surface where all the pore spaces are filled with water. Zone of groundwater occurrence.

Sediments. Geologic materials formed by the accumulation of debris (e.g. sand and gravel) derived from the weathering and erosion of previously existing rocks or through the accumulation of solid material produced by organisms (e.g. shells, coral, etc.).

Solubility. Refers to the amount of the material that will dissolve in water. High solubility refers to a high dissolved concentration.

Sorption. The process by which a dissolved chemical becomes attached to solids in the aquifer, particularly clay minerals and organic matter. See **Retardation**.

Specific Conductance. See **Conductivity**.

Static water level. The distance from the surface down to the water level in a well when the pump is at rest. The natural level of water in the well.

Storage Coefficient. The fraction of the aquifer that will yield water to a well. Unconfined aquifers generally have higher storage coefficients than confined aquifers because groundwater in unconfined aquifers will drain in response to gravity. Groundwater in confined aquifers is released as a result of a pressure drop only.

Susceptibility. The likelihood that a contaminant can migrate to the aquifer.

SWL. See **Static Water Level.**

Time-of-Travel. The length of time it takes groundwater to move from one point to another. In wellhead protection, the time-of-travel is used to determine the size of the wellhead protection area.

TOT. See **Time-of-Travel.**

Unconfined aquifer. Generally shallow aquifer in which no confining layers occur between the surface and the water table. Recharge to an unconfined aquifer generally occurs from directly above.

Unconsolidated. Applies to geologic materials that are aggregates of loose materials, such as sand, silt and gravel.

Unsaturated Zone. The zone between the surface and the water table. Within the unsaturated zone, all the open spaces are filled primarily with air.

Vadose Zone. See **Unsaturated Zone.**

Vulnerable. The combination of having a contaminant present at the surface and the aquifer being susceptible to contamination.

Water Table. The area between the saturated and unsaturated zone. The top of an unconfined aquifer. The water table often varies in elevation seasonally as the result of high levels of recharge in the rainy season (high water table) or high levels of discharge (use) during the dry season (low water table).

Water Table Aquifer. See **Unconfined Aquifer.**

Wellhead Protection Area. That part of the zone of contribution that will supply water to a well over a particular period of time-of-travel (TOT) for groundwater. In Oregon the TOT used is 10 years.

WHPA. See **Wellhead Protection Area.**

Zone of Influence. The region around a pumping well where the potentiometric surface is lowered as a result of the aquifer yielding water to the well.

Zone of Contribution. The surface area above that part of the aquifer that supplies water to the well.

Appendix

Oregon's Drinking Water Protection Program

Source Water Assessment Fact Sheet

Delineation of a Drinking Water Protection Area: Groundwater Sources



OREGON'S DRINKING WATER PROTECTION PROGRAM



DEQ's Drinking Water Protection Advisory Committee Members

- ◆ Dan Bradley, Committee Chair
Manager, South Fork Water Board
- ◆ Jeff Bauman, Public Works Director
City of Wilsonville
- ◆ Bill Brookes, Sr. Hydrologist
Bureau of Land Management
- ◆ Merlin Brown, City Recorder / Manager
City of Nehalem
- ◆ Steven Bruce, Senior Project Manager
David Newton & Associates
- ◆ Paul Eckley, Chief Utilities Engineer
City of Salem
- ◆ Bob Jones, Sr. Geologist
Medford Water Commission
- ◆ John Ledger, Env./Natural Resources
Associated Oregon Industries
- ◆ Bruce McCammon, Regional Hydrologist
US Forest Service
- ◆ Mike Meszaros, Env. Health Specialist
Curry County Environmental Health
- ◆ Regna Merritt, Program Leader
Oregon Natural Resources Council
- ◆ Jennifer Lee, Groundwater Technician
Oregon Assoc. of Water Utilities
- ◆ Tom Penpraze, Utilities Manager
Corvallis Public Works
- ◆ Laurie Power, Environmental Manager
Eugene Water and Electric
- ◆ Roger Prowell, Water Supervisor
City of Bend
- ◆ Clinton Reeder, Past President
Oregon Wheat Growers League
- ◆ Janet Senior, Senior Planner
Portland Water Bureau
- ◆ Terry Witt, Executive Director
Oregonians for Food and Shelter

Technical Advisory Team

- Donn Miller Water Resources Dept.
- Dennis Nelson Oregon Health Division
- Doug White Dept. Land Conservation & Dept.
- Peggy Vogue Dept. of Agriculture
- Terrence Conlon US Geological Survey
- Sheree Stewart Dept. of Environmental Quality

NEW — Source Water Assessments!

Recent amendments to the federal *Safe Drinking Water Act* (SDWA) provided new resources to the Department of Environmental Quality (DEQ) and the Oregon Health Division (OHD) to provide **drinking water protection** assistance to public water systems and communities. While developing a management plan to protect a public water system will remain voluntary in Oregon, the 1996 SDWA Amendments mandated that state agencies conduct "source water assessments" for every public water system. This means that DEQ and OHD must delineate the groundwater and surface water source areas which supply public water systems, inventory each of those areas to determine potential sources of contamination, and determine the most susceptible areas at risk for contamination. To address these requirements, Oregon DEQ assembled a statewide citizen's advisory committee (Drinking Water Protection Advisory Committee (DWPAAC)) to assist in the expansion of the former wellhead protection program. A document called the "*Source Water Assessment Plan*" was developed to describe the approach Oregon will take to meet the requirements over the next four years. The plan was approved by EPA in July 1999.

There will be approximately 2,700 existing public water systems addressed by this new program over the next three years. Of those, approximately 1,200 will receive full assessments and the 1,500 transient noncommunity water systems will receive limited assessments — assistance through focused outreach from OHD. Consistent with existing statutory authorities, OHD will conduct the groundwater delineations. DEQ will be responsible for the surface water delineations and inventories for all 1,200 systems. DEQ and OHD have nine new federally-funded staff positions to implement the requirements, including program coordination, computer database development, GIS development, technical assistance, contamination source inventories, surface water delineations, groundwater delineations, and susceptibility analyses.

Water systems will receive an assessment report that will provide the basis for developing a protection plan and for making informed land use decisions in the future.

DEQ will also provide increased direct technical assistance to communities that choose to move beyond the assessments and develop a Drinking Water Protection Plan (DWPP). Developing a DWPP facilitates local decision-making as the community determines how to protect their own drinking water sources.



How Do You Develop A Drinking Water Protection Plan?

To develop a Drinking Water Protection Plan, we first determine (or "delineate") the land surface area where the drinking water originates, identify what kind and how many potential contamination sources are within that area, and then determine where the most sensitive or susceptible areas exist within the drinking water protection area. These first three steps constitute the "source water assessments", and these will be performed by the state for the community in the next few years. In some cases, DEQ and OHD will delegate the source water assessment tasks to the community or public water systems that request the opportunity to do their own.

The local community then voluntarily develops a management approach to reduce the risks of groundwater contamination from those sources. Since natural conditions and vulnerability to contaminants vary substantially from one part of Oregon to another, the protection of a public water supply can best be accomplished by the local community using an approach designed by that community. DEQ recommends that the management approach be developed so as to minimize any burdens on individual property owners, but maximize the equity in responsibility for reducing the risks of future contamination. The community may contract to have a plan prepared by a consultant, or choose to develop it with a community team. The process of developing a protection plan is described in detail in the "*Oregon Wellhead Protection Program Guidance Manual*". The document was developed to specifically assist groundwater-based systems. We will be updating the guidance manual in 2000 to include guidance to surface water systems.

The primary incentive for local communities to voluntarily implement drinking water protection is the benefit of a more secure source of high quality water. Other (perhaps more tangible) incentives include lower costs to the public by: (a) a reduction in OHD public water supply monitoring requirements, and (b) reduced likelihood of costs for replacement and/or treatment of contaminated drinking water. Long-term assurances of a safe and adequate drinking water supply also helps to protect property values and preserve the local and regional economic growth potential for the area. Developing a plan to protect a public water system is always a cost effective use of resources, since it is extremely expensive to treat contaminated drinking water or to find an alternative source should a water supply be lost because of contamination. DEQ estimates the cost of developing a

Drinking Water Protection Plan for a small community of less than 500 to be approximately \$6,000, compared to typical costs to investigate and install treatment for contamination of at least \$500,000. These numbers are based on actual costs of contamination response in 1992, at a small groundwater-supplied public water system in Marion County. A recent EPA study demonstrated the ratio of contaminant cleanup costs to basic prevention ranges from 5:1 to 200:1.

Technical assistance is available and is provided to the communities by DEQ and OHD as they work through the process. Other agencies will also be involved in providing technical assistance as protection plans are developed. For example, on farmlands, the Oregon Department of Agriculture (ODA) will provide assistance as provided for under Senate Bill 1010. In developing recommendations for protecting drinking water source areas, we have sought to maximize the use of existing programs in Oregon such as pollution prevention technical assistance (DEQ), sanitary survey results (OHD), household hazardous waste collection (DEQ), agricultural water quality protection (ODA), water conservation education (Oregon Water Resources Department - WRD), rural water quality outreach (OSU Extension Service.), etc.

Protecting the drinking water supply in a community can also be a very effective way to encourage all "stakeholders" to participate in an issue which directly affects everyone in that community. This often leads to more public involvement in other significant local decisions concerning future livability issues (i.e., land use planning). In communities already developing and implementing Drinking Water Protection Plans, the process has served to bring many diverse interests together on a common goal and strengthen the local rural and urban relationships through communication and increased understanding of the typical adversarial priorities.

Where Can I Get More Information?

This fact sheet has been prepared to summarize the new source water assessment requirements and briefly describe how the assessment results may be used by local governments, community planners, public water systems, and others to develop provisions to protect their public water supply. For additional information, to obtain a copy of Oregon's "*Source Water Assessment Plan*", or to arrange a presentation on drinking water protection, contact **Sheree Stewart**, Drinking Water Protection Program Coordinator, Oregon DEQ (503-229-5413), or **Dennis Nelson**, Groundwater Coordinator, Oregon Health Division (541-726-2587).

Accessibility Information

This publication is available in alternate format (e.g., large type, braille) by calling DEQ Public Affairs at (503) 229-5317 or toll free within Oregon at 1-800-452-4011. People with hearing impairments can call DEQ's TTY number at (503) 229-6993.

Source Water Assessment Fact Sheet

There are 3,619 public water systems in Oregon, varying from campgrounds and small residential areas to major cities. The federal Safe Drinking Water Act requires that these systems test their water to ensure that it meets drinking water standards. If pollutants are found in excess of these standards, the system must treat the water prior to sending it to their customers. Because of the high cost of treatment, as well as the long-term impact on the drinking water resource, the Safe Drinking Water Act now recognizes that an important way to keep drinking water safe is to prevent contamination from happening in the first place. To do this, the water system must know where the drinking water comes from, the potential sources of contamination in that area, and the susceptibility of the drinking water to these potential sources.

The 1996 Amendments to the Safe Drinking Water Act directs states to conduct Source Water Assessments, i.e., provide water systems with the information described above. Specifically, for all federally recognized water systems, Oregon must identify where the drinking water comes from, i.e., the drinking water protection area (DWPA), inventory potential contaminant sources within the DWPA, and determine the susceptibility of the aquifer to contamination. The Oregon Health Division (OHD) and the Department of Environmental Quality (DEQ) are cooperating to provide this information to water systems. Assessments are to be completed by early 2003.

For groundwater-based systems (wells and springs), OHD will identify the DWPA, i.e., the area on the surface that directly overlies that part of the aquifer that supplies water to the system over the next 10 years. DEQ will inventory potential contaminant sources within the DWPA and will assist OHD in the susceptibility analysis. This information will be provided to the community as a Source Water Assessment Report, consisting of maps and discussions pertaining to the systems drinking water source. An important part of the assessment report will be a map showing the DWPA, highly sensitive areas within the DWPA, and the distribution of potential contaminant sources in the area (see figure). Given this information, water systems and the people they serve can focus their protection strategies in areas where they will do the most to protect the drinking water source.

It is hoped that water systems and their communities will utilize the Source Water Assessment Report to develop strategies to minimize the threat from the potential contaminant sources and in making informed land use decisions. The DEQ will provide technical assistance to communities that wish to develop drinking water protection plans. For more information, contact the Health Division's Drinking Water Protection Unit at 541-726-2587 or the DEQ's Drinking Water Protection Program at 503-229-5664.

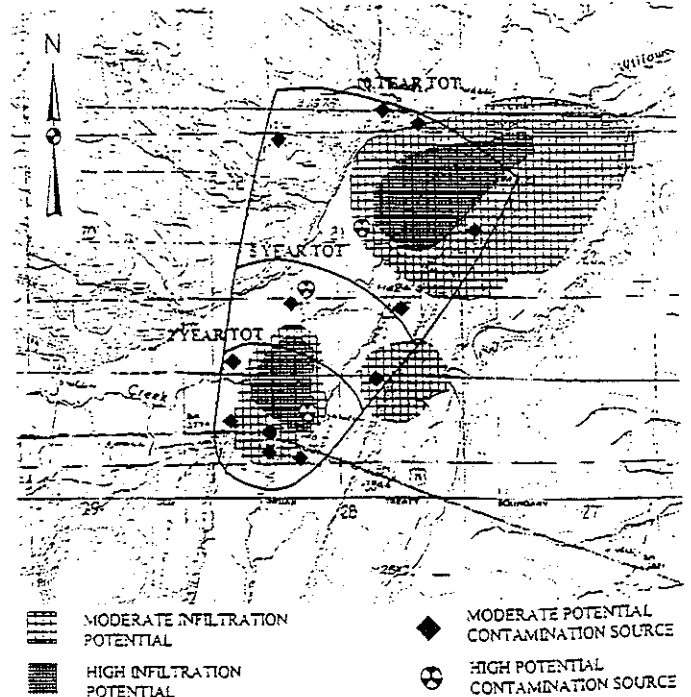

What do we mean by Delineation? Delineation means the determination of the extent, orientation and boundaries of a drinking water protection area using factors such as geology, aquifer characteristics, well pumping rates, and time of travel (TOT).

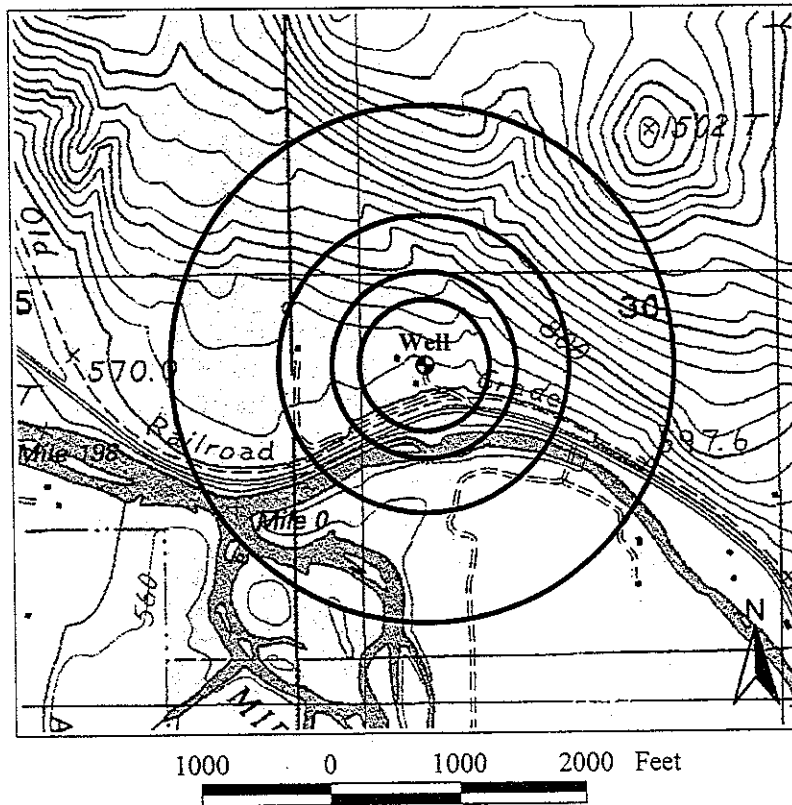

Figure 1. Example of a Calculated Fixed Radius showing 1, 2, 5, and 15 year TOT's.

What exactly is the Calculated Fixed Radius Method? The CFR method assumes a static system, i.e., there is no groundwater flow, and that all of the water released to the well comes from storage within the aquifer right around the well. Using water use, aquifer porosity and thickness (see example in figure 1) the technique determines the volume of the aquifer that is needed to supply the demand from the well over the time-of-travel period, namely 1, 2, 5, and 15 years.

How is the delineation accomplished?

We must identify and characterize the aquifer(s) that supply the well, what is their porosity and thickness? Much of the information comes from well reports, i.e., the reports filed by drillers when the well was drilled (available from the local Watermaster or the Health Division), or other reports that have been completed. To characterize the aquifer we must rely on pump tests, water use information supplied by the well owner/operator, or estimates of water usage when no meters are present.

If you have any questions, please contact Oregon Health Division's Drinking water Protection Unit at (541) 726-2587.

DELINEATION OF A DRINKING WATER PROTECTION AREA: GROUNDWATER SOURCES

Oregon Health Division Drinking Water Program

The 1986 Amendments to the Safe Drinking Water Act required states to develop Wellhead Protection Programs. The goal of wellhead protection was to encourage public water systems using groundwater, i.e., wells or springs, to protect their resource from potential contamination. The steps that were developed in Oregon's EPA-approved program included (1) the delineation or identification of the drinking water protection area around the well or spring, (2) identification of potential contaminant sources within that area, and (3) the development, by the local community, of management strategies to reduce the risk of contamination from those sources. Collecting the necessary information to put together a plan was considered the responsibility of the community or water system. The 1996 Amendments to the Safe Drinking Water Act went a step further by requiring states to conduct Source Water Assessments for all public water systems, including both groundwater and surface water sources. Under the Source Water Assessment program, Oregon will complete the delineation of the drinking water source and the inventory of potential contaminant sources at no cost to the community or water system. This Fact Sheet focuses on the delineation step, describing the process and what data is necessary to do the delineation.

In order to adequately delineate the drinking water protection area (DWPA), there are several questions we must be able to answer:

How Does Groundwater Occur in the Subsurface? Groundwater occurs in the open spaces and fractures in the geologic materials, e.g., sediment and bedrock, that occur beneath the surface. Aquifers are any geologic material where the open spaces are filled with water (i.e., it is saturated) and through which groundwater can move at a rate and quantity sufficient to supply a well. In Oregon, typical aquifers include alluvial sediments (river sands and gravels), basalt aquifers and fractured bedrock.

Where Does Groundwater Come From? Groundwater is part of the global hydrologic cycle that controls the distribution of water on Earth. It originates through the infiltration of precipitation that falls on the land surface and sinks through the soil. For shallow wells (<100 feet), the recharge area is often the immediate vicinity around the well. For deeper aquifers, the recharge area may be several miles or more away. Obviously, if the infiltrating water encounters any contaminant, at or below the surface, some of the contaminant may be dissolved and carried downward.



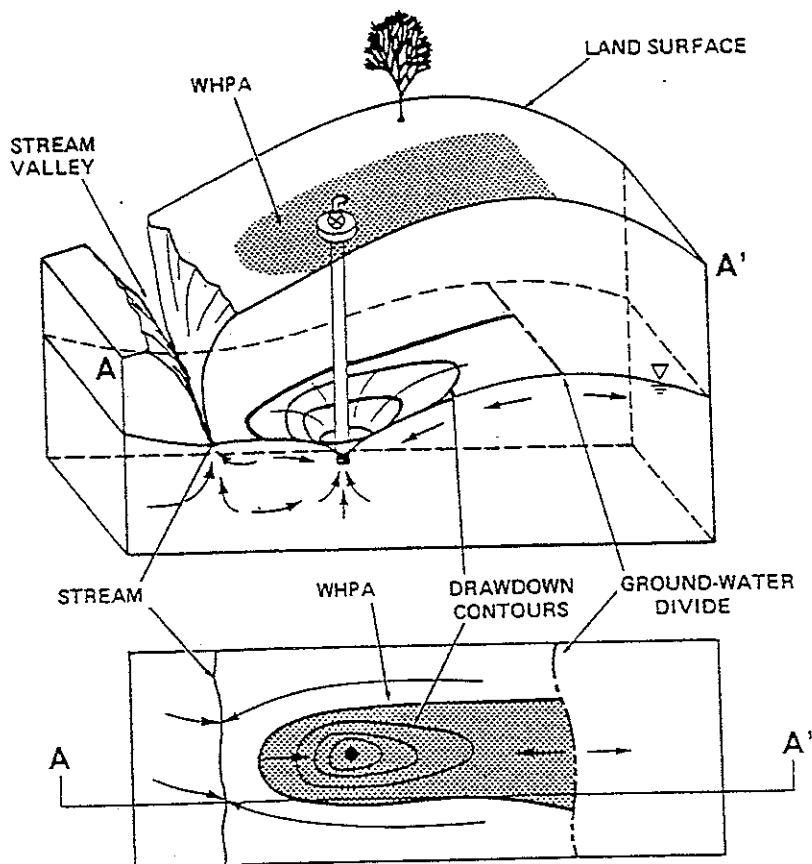

What Controls the Movement of Groundwater? The water table is the upper surface of the saturated zone. Groundwater tends to move from areas where the water table is high to where it is low. How fast groundwater moves depends on the permeability of the aquifer and the slope of the water table. Pumping wells can have an influence on the direction and rate of groundwater movement because the draw down they produce changes the shape and slope of the water table.

What do we mean by Delineation? The accompanying EPA figure helps to illustrate the relation between the DWPA and aquifer supplying the well. The upper diagram represents a 3-D view of an area showing the land surface and the water table. When the well is turned on, it lowers the water table (draw down) in its vicinity and begins to intercept water that is flowing downgradient (see arrows to immediate right of well) towards the well. This creates a capture zone, i.e., that part of the aquifer that supplies water to the well. That capture zone is shown in map view as the stippled area in the lower diagram. Any water molecule that is within the stippled area will move downgradient until it begins to "feel" the draw down related to pumping and, as a result, moves into the well. Water outside the stippled area may have its path changed slightly (note curved arrows illustrating

flow paths), but will move on past the well. The stippled area in the upper diagram (labeled as WHPA) is the DWPA for this well. It is in this area that if a contaminant is released it can be carried down to the capture zone for the well and be transported into the well by groundwater movement in the aquifer.



LEGEND:

-  Water Table
-  Pumping Well
-  Ground-water Divide
-  Direction of Ground-water Flow
-  WHPA

Source: EPA Document 440/6-87-010 (1987)

How is the delineation accomplished? To delineate a water system serving a population of more than 500 people, the following data must be collected:

1. We must identify and characterize the aquifer(s) that supply the well, what is their permeability, their thickness and extent? Much of this information comes from well reports, i.e., the reports filed by drillers when the well was drilled (available from local Watermaster), or other reports that have been completed. Wells must be located on a map and the various geologic units identified from the well log and pieced together to get a 3-D picture of the subsurface. To characterize the aquifer we must rely on pump tests or, in some cases, estimates based on well report descriptions.

2. What is the slope of the water table and what direction does groundwater move naturally? For some systems, available reports will provide this information. For others, area wells must be selected for measurement. The at rest water levels (water table) are measured area wide so that the shape of the water table can be identified. From this the direction of groundwater flow can be determined and the velocity calculated.

3. We use a computer model to determine the capture zone. There are many models available for accomplishing these tasks. The input to the models must be carefully selected to represent the actual groundwater system being considered.

If you have any questions, please contact the Health Division's Drinking Water Protection Unit at (541) 726-2587.

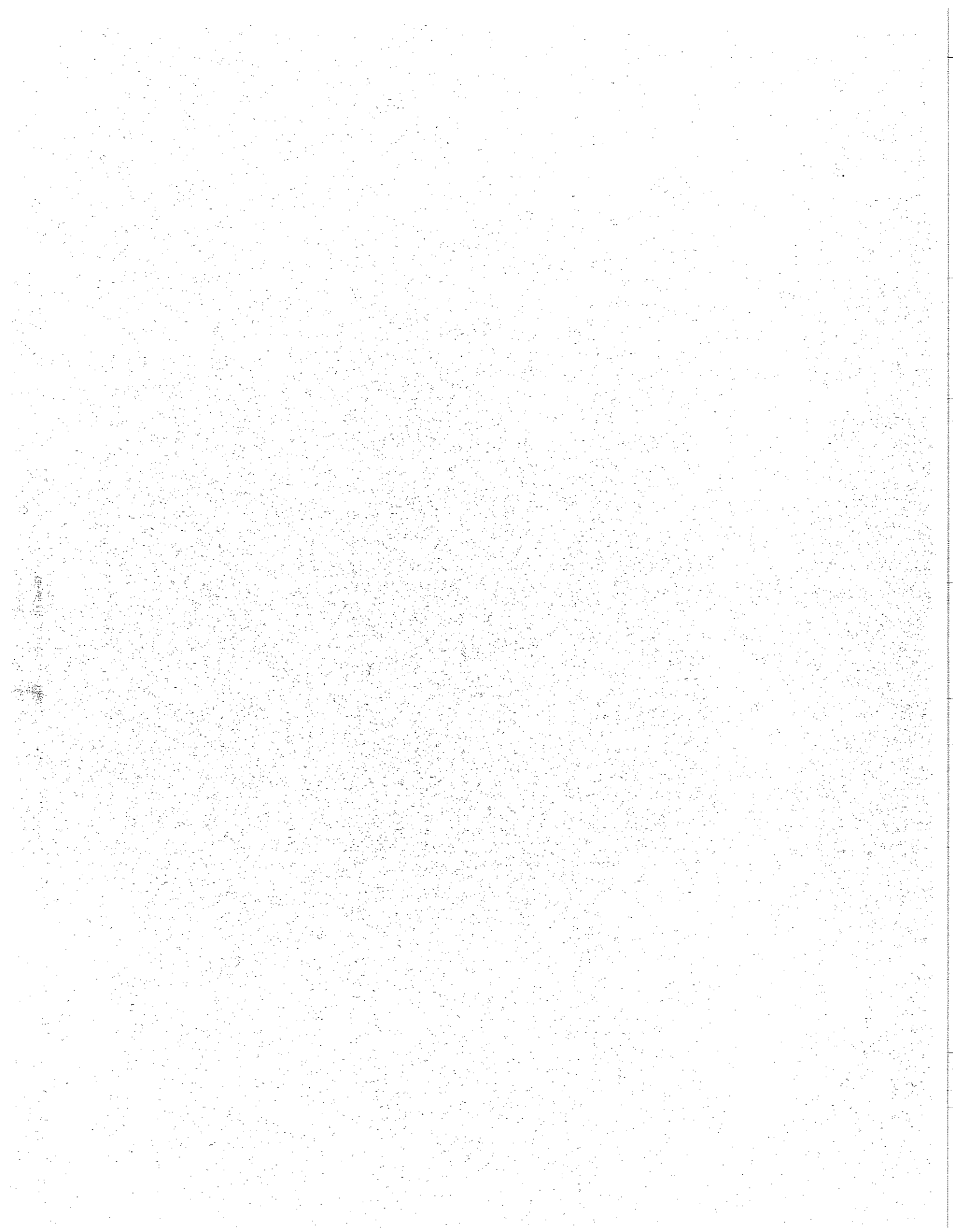



HEALTH DIVISION

Oregon Department of Human Services
800 NE Oregon St.
Portland, Oregon 97232