

OREGON TRANSPORTATION COMMISSION
Standards for Accessible Parking Places
May 2012

In accordance with Oregon Revised Statute (ORS) 447.233, the Oregon Transportation Commission (OTC) adopted standards for accessible person parking places, which took effect on January 22, 1992. All new construction or re-stripping of accessible parking spaces and access aisles is required to meet new minimum standards.

The layouts, signing, and pavement marking standards for accessible parking places presented in this document have been adapted from and shall comply with the listed "referenced standards" shown on page 5. Further information and requirements for accessible design can be found in the "referenced standards".

OREGON TRANSPORTATION COMMISSION
Standards for Accessible Parking Places
May 2012

Parking Lot Layout

An accessible parking space shall be at least 9' wide with an adjacent access aisle at least 6' wide. The access aisle shall be at least 8' wide for an accessible parking space designated as "van-accessible" or reserved for wheelchair users only. Example layouts are shown in Figures 1 through 5.

The access aisle must be located on the passenger side of the parking space (Figure 1) except that two adjacent accessible parking spaces may share a common access aisle (Figures 2, 3, and 5).

Refer to Chapter 11 of the 2010 Oregon Structural Specialty Code to calculate the required number of accessible parking spaces and for other requirements.

Pavement Markings

Details of pavement markings are shown in Figures 1 and 2. Each accessible parking space shall have a pavement marking stencil as shown in Figure 6. Pavement markings and stencils are required to be white and should be retroreflective. The use of blue curb and blue background on pavement marking stencils is optional.

The symbol for the pavement marking stencil is the international symbol of access as shown in the Standard Highway Signs book published by the Federal Highway Administration (FHWA).

Pavement marking stencil is available in two different sizes:

- Minimum - Used for facilities not on the state highway right-of-way.
- Standard – Used for facilities on the state highway right-of-way.

Sign Design

Each accessible parking space shall have the appropriate sign(s) as required below. All signs are required to be retroreflective.

There are three different signs that are used for accessible parking spaces:

- Sign No. R7-8¹ (Figure 7) - This is the standard sign used to designate accessible parking spaces. All accessible parking spaces shall have this sign. The symbol for this sign is the international symbol of access as shown in the Standard Highway Signs book published by the FHWA.

¹ Sign No. OR7-8 may be used instead of R7-8 until March 1, 2013.

OREGON TRANSPORTATION COMMISSION
Standards for Accessible Parking Places
May 2012

- Sign No. R7-8P² (Figure 8) - The “VAN ACCESSIBLE” sign is used with R7-8 sign to designate those accessible parking spaces that have a minimum 8’ wide access aisle. Any vehicle with a DMV disabled permit can use van-accessible spaces.
- Sign No. OR7-8c³ (Figure 9) - The “WHEELCHAIR USER ONLY” sign is used with R7-8 and R7-8P signs to designate those accessible parking spaces that have a minimum 8’ wide access aisle and are reserved for wheelchair users only. Only those vehicles with a DMV disabled permit displaying a “Wheelchair User” placard or decal can use these parking spaces.

Sign Mounting

Post-mounted signs shall be installed with a vertical clearance of 7’ (± 3 ”) between the bottom of the sign to the ground line. If more than one sign is required for an accessible parking space, all signs shall be mounted on a single post. When signs are mounted on buildings or piers, a vertical clearance of 5’ minimum shall be maintained between the bottom of the sign and the floor of the parking space. The sign(s) shall be laterally placed within the accessible parking space as shown in Figures 1 and 2.

Posts and hardware used to mount signs on the state highway right-of-way shall be according to ODOT standard drawings and standard specifications for construction. Posts and hardware used to mount signs on public right-of-way other than state highways may have different requirements. Posts and hardware used to mount signs on private right-of-way are at the discretion of the owner. It is advisable to contact an engineer for an analysis of post and mounting hardware if in doubt.

Other Considerations

On state highway right-of-way, requests for work must be submitted through the appropriate ODOT District Office. All work must meet the applicable ODOT standards and specifications.

On public or private right-of-way other than on the state highway, requests for work must be submitted through the appropriate local jurisdiction. This may include the Public Works Department, the Local Building Department and/or the Building Codes Division. All work must meet the applicable local agency and/or Building Codes Division standards and specifications

² Sign No. R7-8B shall be used instead of R7-8P if OR7-8 is used.

³ Sign No. OR7-8c with blue background shall be used instead of white background if OR7-8 is used.

OREGON TRANSPORTATION COMMISSION
Standards for Accessible Parking Places
May 2012

Contacts

Contractors/Suppliers - A list of sign suppliers, striping contractors, and pavement marking stencil sources is shown in Page 15 for convenience. ODOT doesn't guarantee the accuracy of the information presented in the list.

Building Codes Division - For questions regarding the Oregon Structural Specialty Code, Chapter 11 – Accessibility, enforcement of accessible design standards, and inspections, contact:

- ADA Specialist – Tony Rocco 503-373-7529
E-mail: Anthony.J.Rocco@oregon.gov

Oregon Department of Transportation (ODOT) - For questions regarding the information contained within this document, ODOT standards & specifications, and ODOT processes/procedures, contact:

- Traffic Devices Engineer – Eric Leaming, PE 503-986-3610
E-mail: Eric.S.Leaming@odot.state.or.us
- State Sign Engineer – Heidi Shoblom, PE 503-986-3603
E-mail: Heidi.E.Shoblom@odot.state.or.us

The Driver and Motor Vehicle Services Division (DMV) - For questions regarding obtaining and using disabled vehicle permits, contact your local DMV office found in the government pages of the phone book. <http://www.oregon.gov/ODOT/DMV>

Local Police Agency - For questions regarding enforcement of individuals parking improperly in an accessible space, contact your local police agency found in the government pages of the phone book.

Advocacy Groups – For general accessible parking info, support, and resources, contact:

- Oregon Paralyzed Veterans of America – 503-362-7998 or 800-333-0782
<http://www.oregonpva.org/>
- Oregon Disabilities Commission- 503-945-5811 or 800-282-8096
<http://www.oregon.gov/DHS/spd/adv/odc/index.shtml>
- Northwest ADA Center- 425-248-2480 or 800-949-4232
<http://www.dbtacnorthwest.org/contact-us>
- U.S. Department of Justice- 800-514-0301
<http://www.ada.gov/>

OREGON TRANSPORTATION COMMISSION
Standards for Accessible Parking Places
May 2012

Referenced Standards

- 1) Oregon Revised Statute (ORS) 447.233: <http://www.leg.state.or.us/ors/447.html>
- 2) Oregon Structural Specialty Code, Chapter 11 – Accessibility :
http://ecodes.biz/ecodes_support/free_resources/Oregon/10_Structural/10_ORStructural_main.html
- 3) 2010 ADA Standards for Accessible Design:
http://www.ada.gov/2010ADASTandards_index.htm
- 4) FHWA Standard Highway Signs (SHS): http://mutcd.fhwa.dot.gov/ser-shs_millennium.htm
- 5) Manual on Uniform Traffic Control Devices (MUTCD): <http://mutcd.fhwa.dot.gov/>
- 6) ODOT Standard Drawings:
http://www.oregon.gov/ODOT/HWY/ENGSERVICES/standard_drawings_home.shtml
- 7) ODOT Standard Specifications:
<http://www.oregon.gov/ODOT/HWY/SPECS/index.shtml>
- 8) ODOT Sign Policy and Guidelines:
http://www.oregon.gov/ODOT/HWY/TRAFFIC-ROADWAY/sign_policy.shtml

OREGON TRANSPORTATION COMMISSION
Standards for Accessible Parking Places
May 2012

MINIMUM STANDARD
 SINGLE-ACCESSIBLE PARKING SPACE
 (VAN-ACCESSIBLE DESIGNATION REQUIRED)

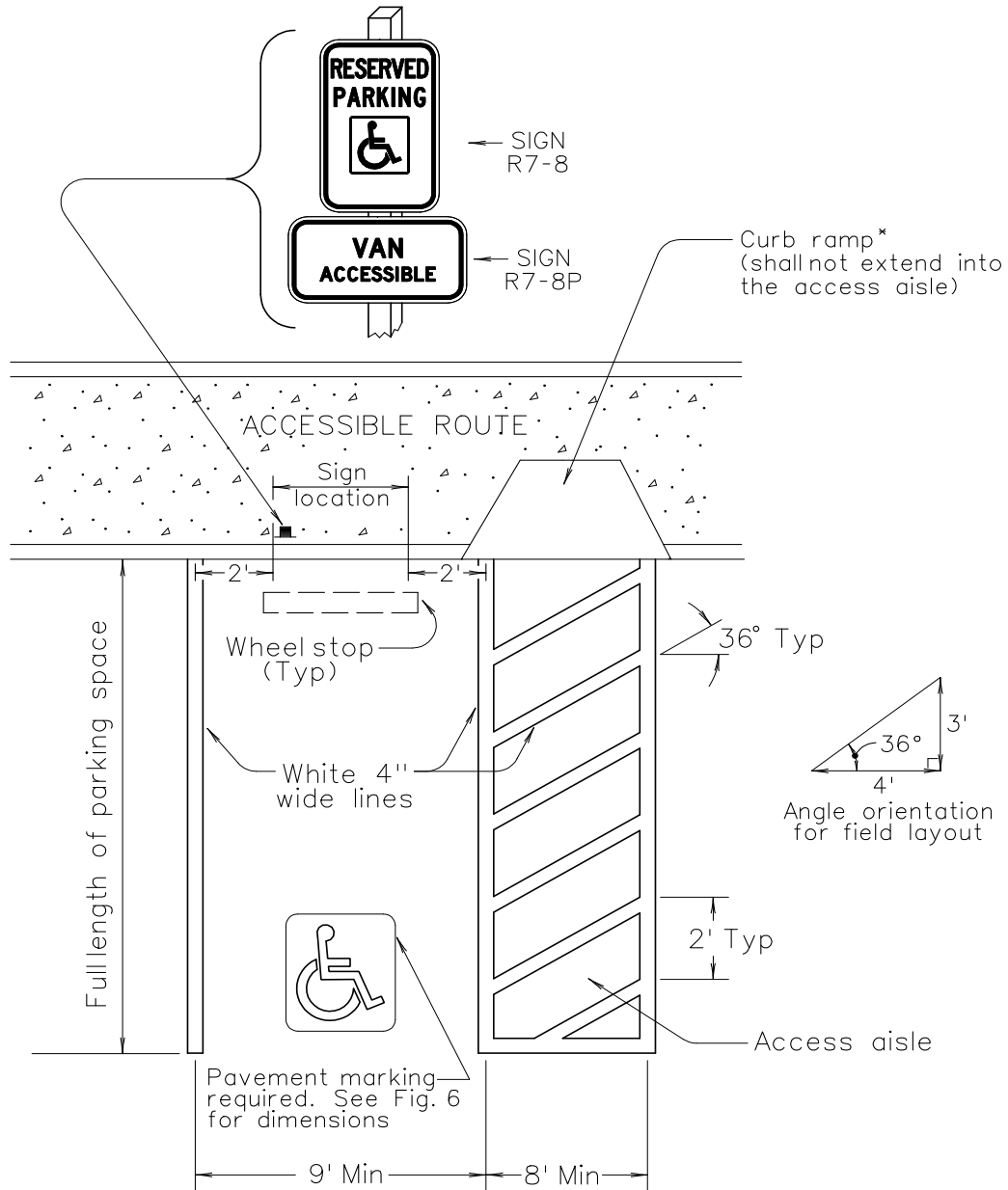

* Detectable warning surface required if curb ramp is located within public right-of-way

Figure 1

OREGON TRANSPORTATION COMMISSION
Standards for Accessible Parking Places
May 2012

MINIMUM STANDARD
 DOUBLE-ACCESSIBLE PARKING SPACE
 (ONE VAN-ACCESSIBLE DESIGNATION REQUIRED)

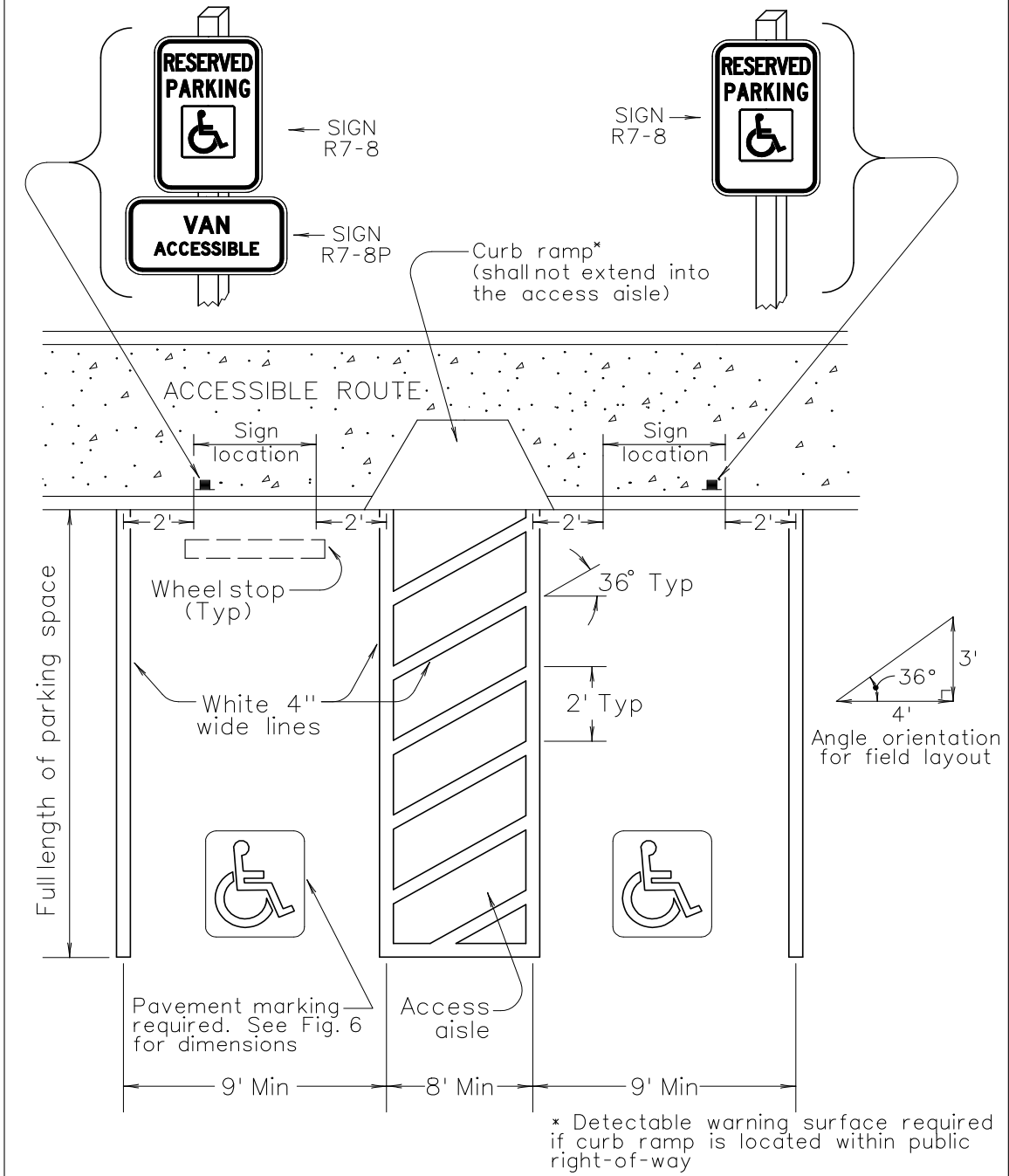

Figure 2

OREGON TRANSPORTATION COMMISSION
Standards for Accessible Parking Places
May 2012

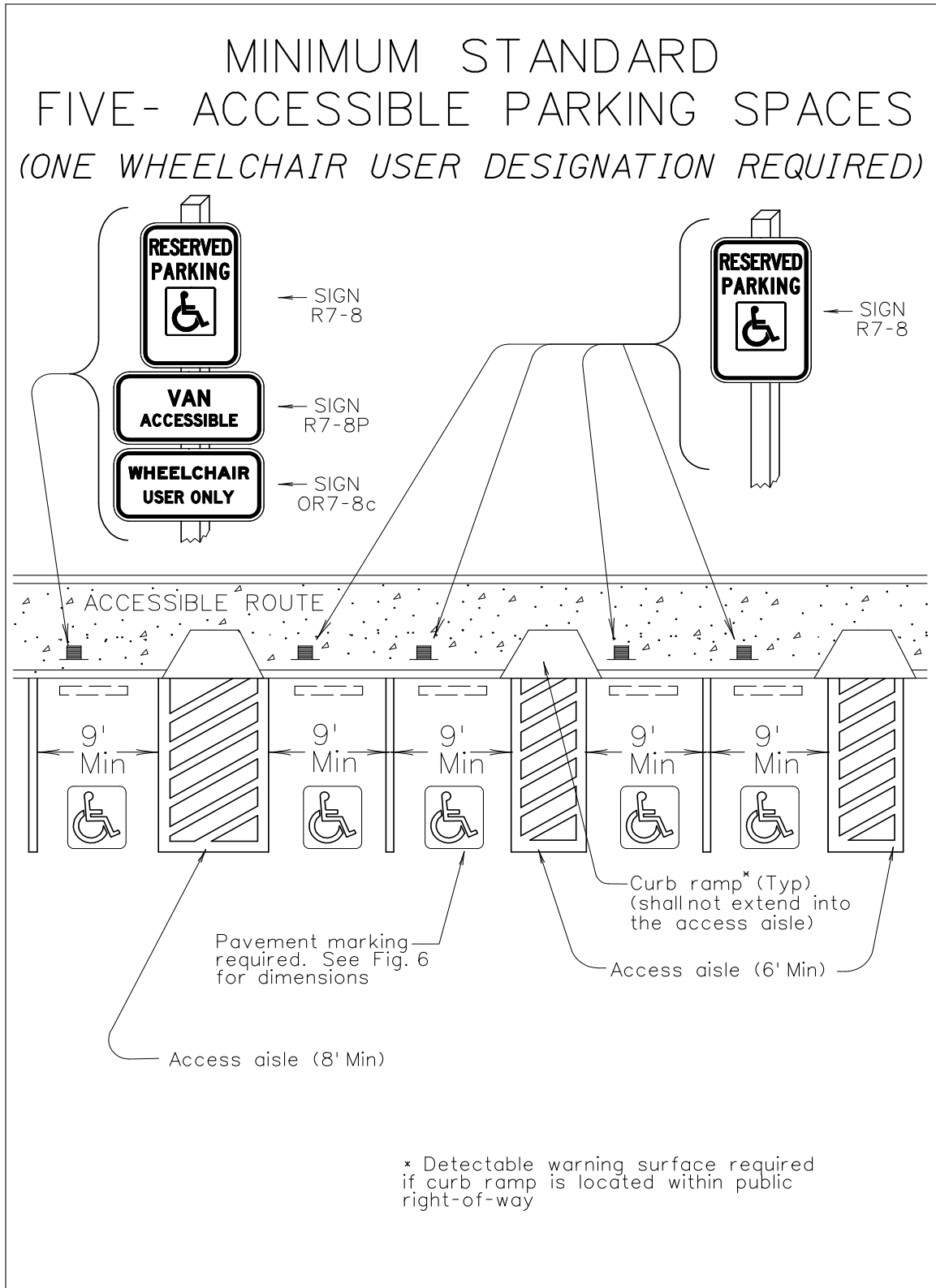

Figure 3

OREGON TRANSPORTATION COMMISSION
Standards for Accessible Parking Places
May 2012

PARALLEL-ACCESSIBLE PARKING LAYOUT

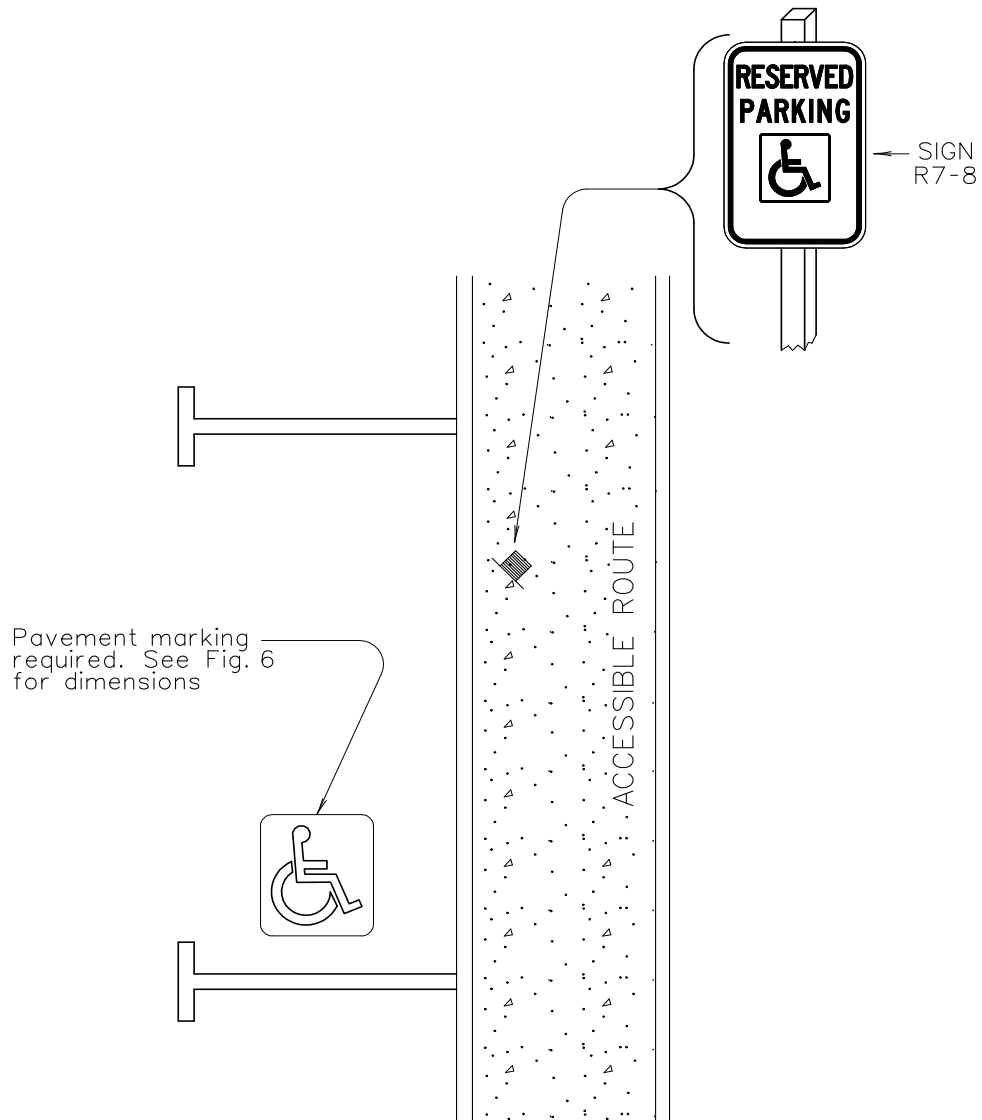

Figure 4

OREGON TRANSPORTATION COMMISSION
Standards for Accessible Parking Places
May 2012

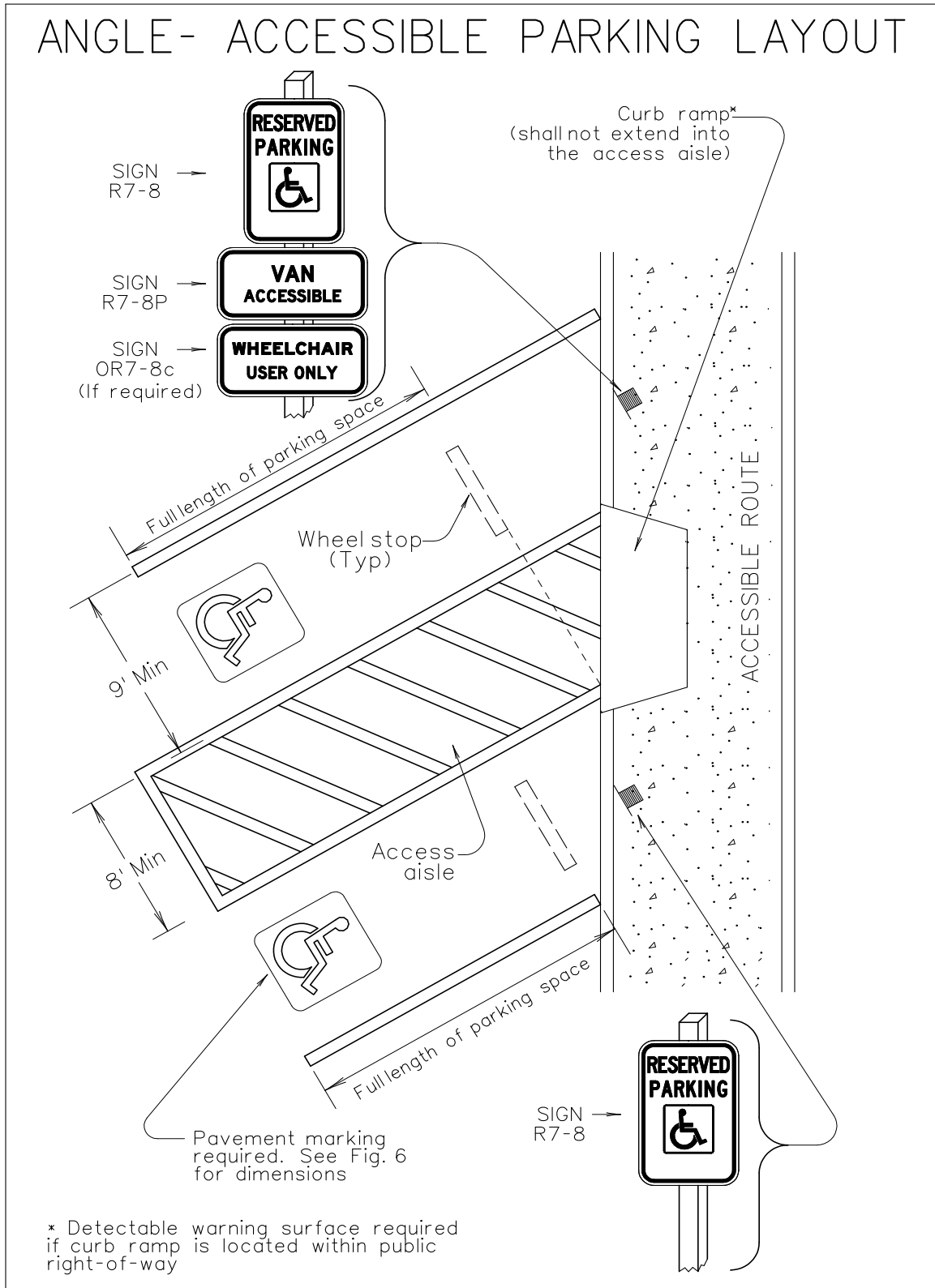
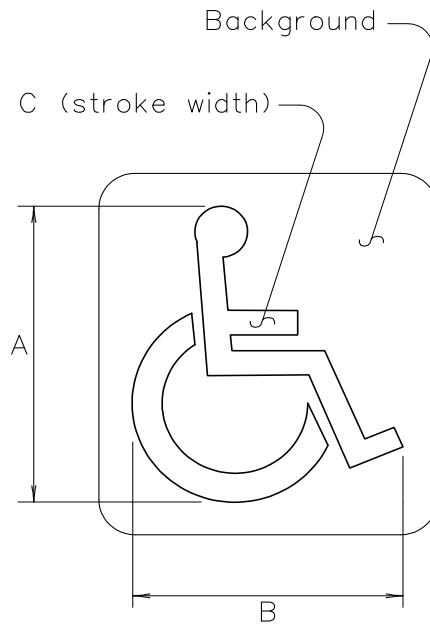

Figure 5

OREGON TRANSPORTATION COMMISSION
Standards for Accessible Parking Places
May 2012

PAVEMENT MARKING STENCIL



Pavement Marking Background: Optional: Blue, Retroreflective

Pavement Marking Stencil: White, Retroreflective

LEGEND	DIMENSIONS (INCHES)						
	A	B	C	D	E	F	G
MINIMUM	28	24	3				
STANDARD	41	36	4				

The pavement marking stencil shall be used to designate an accessible parking area reserved for vehicles with DMV permits.

Figure 6

OREGON TRANSPORTATION COMMISSION
Standards for Accessible Parking Places
May 2012

SIGN DESIGN
 SIGN NO. R7-8



Sign Background: White, Retroreflective sheeting

Sign Legend: Green, Retroreflective sheeting

Sign Symbol: White on Blue, Retroreflective sheeting

Refer to Standard Highway Signs book for details.

The Disabled Person parking sign is used to designate a parking area reserved for vehicles with DMV permit as stated.

Figure 7

OREGON TRANSPORTATION COMMISSION
Standards for Accessible Parking Places
May 2012

SIGN DESIGN
SIGN NO. R7-8P



Sign Background: White, Retroreflective sheeting

Sign Legend: Green, Retroreflective sheeting

Refer to Standard Highway Signs book for details and dimensions.

The VAN-ACCESSIBLE sign shall only be used with sign R7-8 to designate the parking spaces that have an access aisle 8 ft or wider

Figure 8

OREGON TRANSPORTATION COMMISSION
Standards for Accessible Parking Places
May 2012

SIGN DESIGN
 SIGN NO. OR7-8c

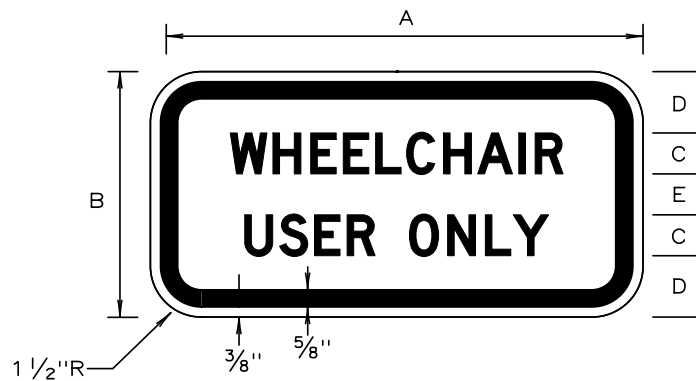

Sign Background: White, Retroreflective sheeting

Sign Legend: Green, Retroreflective sheeting

LEGEND	DIMENSIONS (INCHES)				
	A	B	C	D	E
MINIMUM	12	6	1D	1 ⁵ / ₈	3/4
STANDARD	18	9	1 ¹ / ₂ D	2 ¹ / ₄	1 ¹ / ₂

The WHEELCHAIR USER ONLY sign shall only be used with the Disabled Person Parking Sign (R7-8) and the VAN ACCESSIBLE sign (R7-8P) to designate the wheelchair user only spaces as defined in ORS 447.233.

Figure 9

OREGON TRANSPORTATION COMMISSION

Standards for Accessible Parking Places

May 2012

Sign Suppliers

Contact Name	Organization	Address	City	State	Zip	Phone	Fax	Web Site	E-mail
David or Peter Fick	Allstate Sign & Plaque Corp	70 Burt Dr.	Deer Park	NY	11729	631-242-2828	631-242-2433	www.allstatesign.com	david.fick@allstatesign.com
Blaine Wilson	All-Ways Striping	3330 Bellinger Lane	Medford	OR	97501	541-779-9200	541-690-1205	www.all-waysstriping.com	all-ways@charter.net
Naomi Kerr	American Barricade Co.	60 Grimes Street	Eugene	OR	97402	541-343-0143	541-343-2923	www.barricade.com	
Carl Savage	American Barricade Co.	173 NE Columbia Blvd.	Portland	OR	97211	503-285-6616	503-285-1827	www.barricade.com	carls@gmail.com
Jon Krausch	American Barricade Co.	2910 Pringle Rd. SE	Salem	OR	97302	503-378-0020	503-378-1809	www.barricade.com	
Andy Sisavic	Beaverton Fast Signs	11870 SW Beaverton	Beaverton	OR	97005	503-526-0216	503-643-0471	www.fastsigns/46.com	andy.sisavic@fastsigns.com
Mike Moe	Budget Instant Signs	10572 SE Washington St.	Portland	OR	97216	503-257-7229	503-257-3941	www.budget-instant-signs.com	budsigns1@hotmail.com
Judy Hughes	Cantel of Medford	3981 Crater Lake Highway	Medford	OR	97504	541-773-2765	541-776-9060	www.cantelofmedford.com	judy@cantelofmedford.com
Peter Carlson	Carlson Sign Company	1605 NE Forbes Rd	Bend	OR	97701	541-382-2182	541-382-2196	www.carlsonsign.com	pcarlson@carlsonsign.com
Kim McLean	Eastern Metal (USA Sign)	1430 Sullivan St	Elmira	NY	14901	800-872-7446	607-734-8783	www.usa-sign.com	kmclean@usa-sign.com
Gary or Peggy Olstad	Eugene Speedi Sign	459 River Ave	Eugene	OR	97404	541-461-7276	541-463-1234	www.eugenespeedisign.com	speedisign@qwestoffice.net
Steve Brennock	Fast Signs - Tigard	11525 SW Pacific Highway	Tigard	OR	97223	503-244-8813	503-244-7753	www.fastsigns.com/314	314@fastsigns.com
Kim Snook/Buck Johnson	4S Sign LLC	30255 Highway 34	Albany	OR	97321	541-928-5858	541-928-9068	www.4ssign.com	bjohnson@foressign.com
Kristine Pemberton	Hall Signs Inc.	PO Box 515	Bloomington	IN	47402	800-284-7446	812-332-9816	www.hallsigns.com	kristine@hallsigns.com
Rhonda Ferguson	Lyle Signs, Inc	6294 Bury Drive	Eden Prairie	MN	55346	877-895-8816x11	952-934-0406	www.lylesigns.com	rhondaferguson@lylesigns.com
Mary Meyer	Martin Bros. Inc.	3165 Commercial Street SE	Salem	OR	97302	503-364-2211	503-364-4315	www.martin-bros.com	mary@martin-bros.com
Tony McGovern	McGovern Parking Lot Maintenance	PO Box 1107	Lebanon	OR	97355	541-990-5837	541-258-1692		mcmgovernmaintenance@yahoo.com
Greg Andrews	Sign Pro	1048 SE Baseline	Hillsboro	OR	97123	503-693-7300	503-693-6724	www.signpro.com	art@signpro.com
Tom Loun	Traffic Safety Supply Co Inc	2324 SE Umatilla Street	Portland	OR	97202	503-235-8531	503-235-5112	www.tssco.com	tloun@tssco.com
Tim Corkins	Zap Manufacturing	12086 Charles Dr	Grass Valley	CA	95945	800-824-5927	530-477-0751	www.zapmfg.com	sales@zapmfg.com
Jeff LaSource	Zumar Industries Inc.	PO Box 44549	Tacoma	WA	98444	800-426-7967	253-536-8680	www.zumar.com	JeffL@zumar.com

Pavement Marking Stencil Sources

Contact Name	Organization	Address	City	State	Zip	Phone	Fax	Web Site	E-mail
Kim Snook/Buck Johnson	4S Sign LLC	30255 Highway 34	Albany	OR	97321	541-928-5858	541-928-9068	www.4ssign.com	bjohnson@foressign.com
Kristine Pemberton	Hall Signs Inc.	PO Box 515	Bloomington	IN	47402	800-284-7446	812-332-9816	www.hallsigns.com	kristine@hallsigns.com
Customer Service	Lab Safety Supply	PO Box 1368	Janesville	WI	53547	800-356-0783	800-543-9910	www.labsafety.com	custsvcs@labsafety.com
Tom Loun	Traffic Safety Supply Co Inc	2324 SE Umatilla Street	Portland	OR	97202	503-235-8531	503-235-5112	www.tssco.com	tloun@tssco.com
Jeff LaSource	Zumar Industries Inc.	PO Box 44549	Tacoma	WA	98444	800-426-7967	253-536-8680	www.zumar.com	JeffL@zumar.com

Striping Contractors

Contact Name	Organization	Address	City	State	Zip	Phone	Fax	Web Site	E-mail
Jeff Nokleby	A-1 Straight Line Striping (formerly known as Straight Line Striping)	1745 Barnes Ave SE	Salem	OR	97306	503-364-0652	503-391-1140		jjnuck000@aol.com
Mike Lewis	AAA Striping (formerly known as Arrow Striping)	2646 Lone Pine Road	Medford	OR	97504	541-840-4875	541-779-2868		mikewis2@charter.net
Heather Zaha	Accurate Striping, Inc	PO Box 2617	Battleground	WA	98604	360-687-4887	360-687-9469	www accuratestripinginc.com	lotstripe@aol.com
John Mildenerger	All-N-One Asphalt Maintenance Inc.	504 Maplewood Dr.	St. Helens	OR	97051	503-397-4257	503-397-3423		sweepinc@colcenter.org
Blaine Wilson	All-Ways Striping	3330 Bellinger Lane	Medford	OR	97501	541-779-9200	541-690-1205	www.all-waysstriping.com	all-ways@charter.net
Dennis Woods	Arrow Striping & Painting, Inc	PO Box 33257	Portland	OR	97292	503-254-7895	503-257-2471	www.arrowstriping.us	dennis_woods@hotmail.com
Carol Ferguson	C & R Striping Co.	PO Box 154	Glide	OR	97443	541-673-5007	541-496-0220		crfergie@centurytel.net
Dustin Moist	Cantel Sweeping & Striping	1709 NW Eleven Mile Ave	Gresham	OR	97030	503-661-4337	503-661-4401	www.cantelsweeping.com	info@cantelsweeping.com
Ryan Olson	Coast Pavement Services	10505 SW Tigard St.	Tigard	OR	97223	503-227-4515	503-639-9405	www.coastpavementservices.com	ryano@coastpavementservices.com
Nathan W.	DMO Striping LLC	1200 Meadowlark Pl.	Molalla	OR	97038	503-600-0057	n/a	www.dmostriping.com	dmostriping@yahoo.com
Joseph Crafts	Harvey's Parking Lot Services	6370 North B Street	Springfield	OR	97478	541-741-2542	541-741-0600		
Ron Hicks	Hicks Striping & Curbing, Inc	PO Box 9127	Brooks	OR	97305	503-364-4577	503-364-4596	www.hicksstriping.com	hicks@hicksstriping.com
Tony McGovern	McGovern Parking Lot Maintenance	PO Box 1107	Lebanon	OR	97355	541-990-5837	541-258-1692		mcmgovernmaintenance@yahoo.com
Kerry Fuller/Jim Pate	Pavement Protectors	PO Box 7197	Bend	OR	97708	541-389-6444	541-383-9302	www.pavepro.net	pavepros@yahoo.com
Darlene Deiter	Star Striping Company	1010 SE 139th	Portland	OR	97233	503-252-0448	503-252-0448		
Russell Dusky	Stripe-Rite Company	3827 E. Main Street	Hillsboro	OR	97123	503-648-7875	503-648-7875		
Dennis Ware	Ware-Ever Striping	13493 SW 75th Place	Tigard	OR	97223	503-620-2225	503-620-8464	www.ware-ever.com	dennis@ware-ever.com
James Lowrey	Vanguard Striping LLC	E. 17th Circle	LaCenter	WA	98629	360-798-9021	886334-4543	www.vanguardstriping.com	james@vanguardstriping.com

Last Updated: February-12