

SILETZ BAY STATE AIRPORT

This report describes how your Pavement Maintenance Management Program (PMMP) was developed. Your Program was developed as part of the Oregon Continuous Aviation System Plan sponsored in part by the Oregon Department of Aviation and the Federal Aviation Administration (FAA). The information and data contained in this report ensures you comply with the requirements of FAA Grant Assurance Number 11 which states that any airport requesting federal funds for pavement improvement projects must have implemented a pavement maintenance management program.

DATA COLLECTION

To determine how your pavements were constructed and their age, a records review was conducted. Figure SB-1 shows the records review results. This figure identifies pavement boundaries, dimensions, pavement layer types, thicknesses and dates of construction. The most recent construction date for each pavement can also be found in the Section Condition Report in Appendix 2. Figure SB-1 and the information contained in Appendices 1, 2 and 4 ensure that your airport complies with the “pavement inventory” requirement of FAA’s PMMP guidelines.

The pavements at your airport were divided into branches, sections and sample units in accordance with the methodology outlined in the current edition of ASTM D5430, *Standard Test Method for Airport Condition Index Surveys*. The branches, sections and sample units established at your airport are shown in Figure SB-2. A Branch Condition Report showing all branches, their associated areas, and their area-weighted average condition is provided in Appendix 1. Additionally, the Appendix 2 Section Condition Report provides information used to define each branch and section in the PAVER database.

Using the branch, section and sample unit divisions established, a visual condition survey was conducted at Siletz Bay State Airport in May 2018. During the inspection, pavement defects were identified and measured in accordance with the methodology outlined in ASTM D5430. This inspection ensures your airport complies with the “detailed inspection” requirement of FAA’s PMMP guidelines. After collection, the data were entered into the PAVER software for analysis. These data are reproduced in the Re-Inspection Report attached as Appendix 4.

The PAVER database updated during this project ensures your airport complies with the “record keeping and information retrieval” requirements of FAA’s PMMP guidelines.

Figure SB-1. Airport Layout, Dimensions and Pavement Cross-Sections.
Siletz Bay State Airport

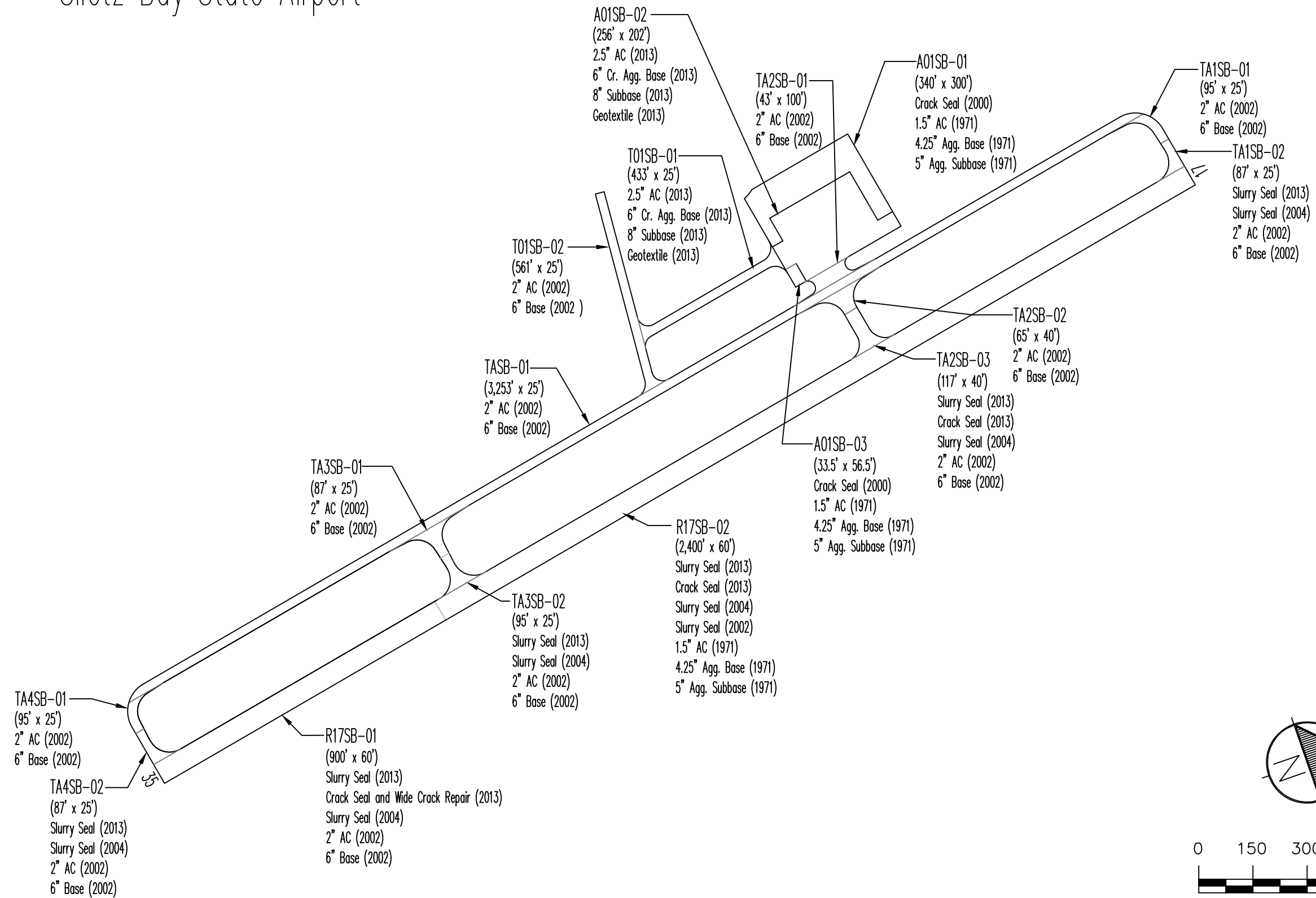

Drawing Date: September 2018

Figure SB-2. Pavement Branch, Section and Sample Unit Layout.
Siletz Bay State Airport

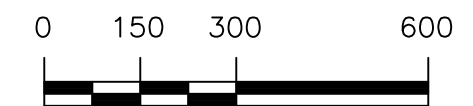
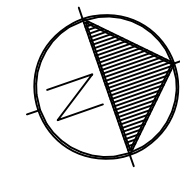
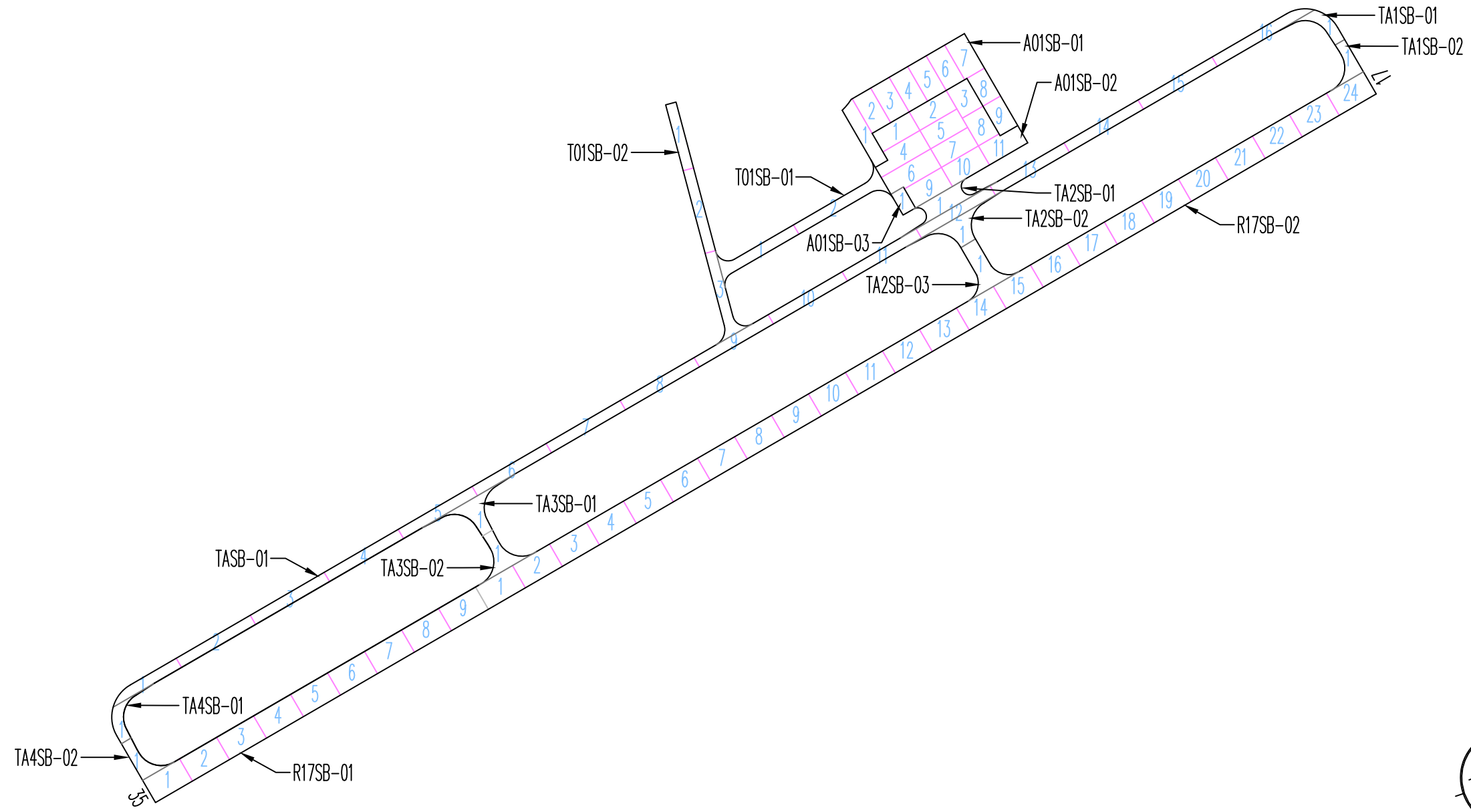

Drawing Date: September 2018

RESULTS

Using the data collected during the visual inspection, the PAVER software was used to calculate an area-weighted average Pavement Condition Index (PCI) for each pavement section inspected using the sample units evaluated. Using each section’s PCI, a Pavement Condition Rating (PCR) was assigned. The PCIs measured during this inspection are shown in Table 1. The table also contains PCIs from past inspections as well as projected PCIs for 2023 and 2028. The projections were based on pavement deterioration models developed by PAVER using the inspection data from other pavements in the same airport category as your airport, located in the same climatic region, and with the same surface type and use.

The Branch Condition Report in Appendix 1 summarizes current pavement condition by branch while the Section Condition Report in Appendix 2 lists pavement condition by section. The current Pavement Condition Rating (PCR) is shown graphically in Figure SB-3.

Table 1. Past, Present and Future Pavement Condition Indices.

Branch	Section	Inspections			Forecast	
		2012	2015	2018	2023	2028
A01SB	01	55	49	42	39	36
A01SB	02	---	100	100	91	89
A01SB	03	---	49	49	46	43
R17SB	01	100	100	99	95	92
R17SB	02	64	75	64	64	64
T01SB	01	---	100	100	89	84
T01SB	02	94	98	92	85	82
TA1SB	01	100	87	82	81	81
TA1SB	02	99	94	88	83	82
TA2SB	01	100	90	81	80	78
TA2SB	02	100	93	79	76	73
TA2SB	03	66	83	62	61	60
TA3SB	01	100	96	79	76	73
TA3SB	02	100	91	91	85	82
TA4SB	01	100	96	77	74	71
TA4SB	02	100	100	84	82	81
TASB	01	99	92	75	72	69

Section PCIs at Siletz Bay State Airport range from a low of 42 (a PCR of “Poor”) to a high of 100 (a PCR of “Good”). The area-weighted average PCI for all airport pavements is 76, corresponding to an overall PCR of “Satisfactory”. Figure SB-4 shows how much pavement area is associated with each Pavement Condition Rating category and also shows pavement condition distribution from the inspections conducted in 2012 and 2015.

Figure SB-3. Pavement Condition in May 2018.
Siletz Bay State Airport

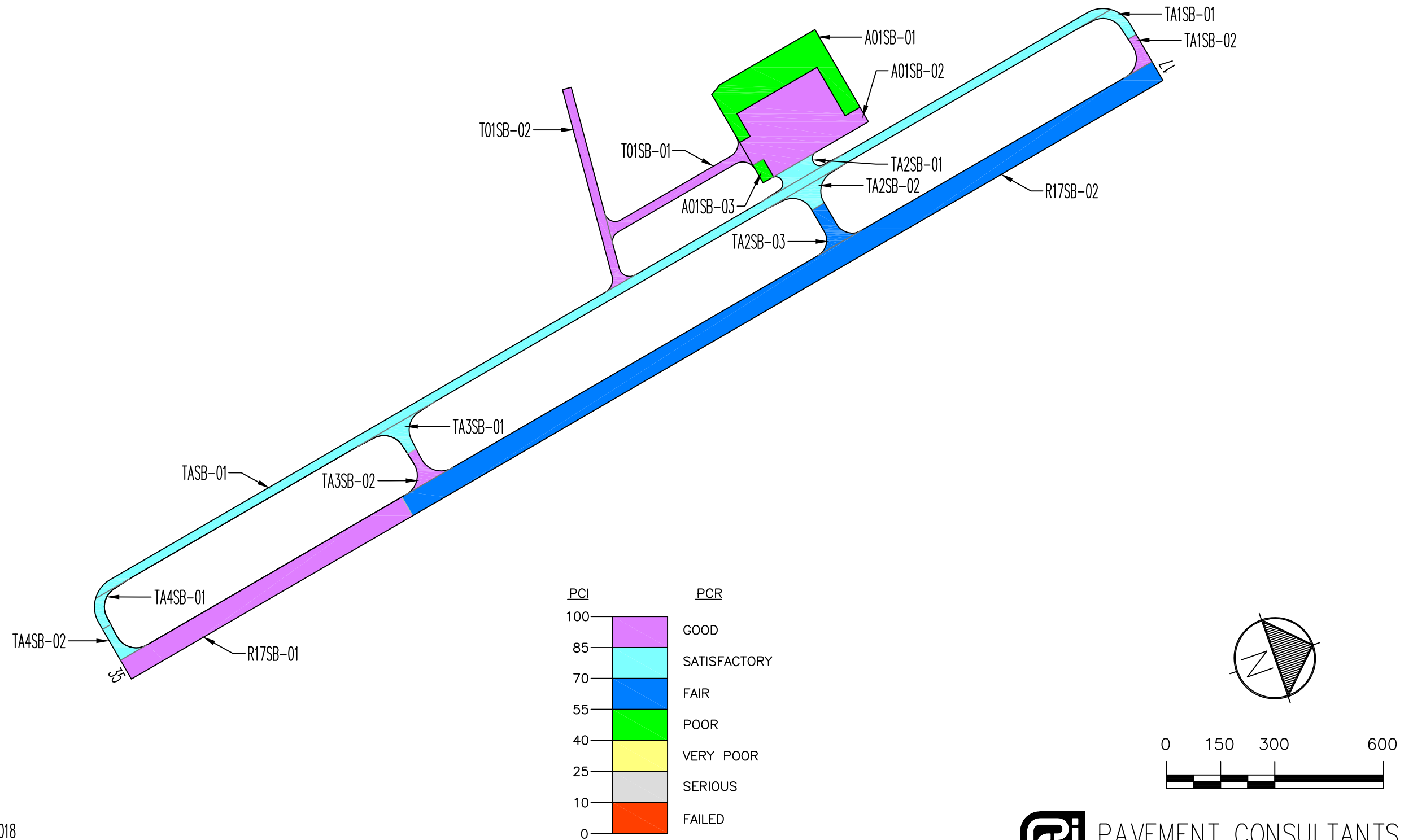

Drawing Date: September 2018

**Figure SB-4. Pavement Condition Distribution
Siletz Bay State Airport**

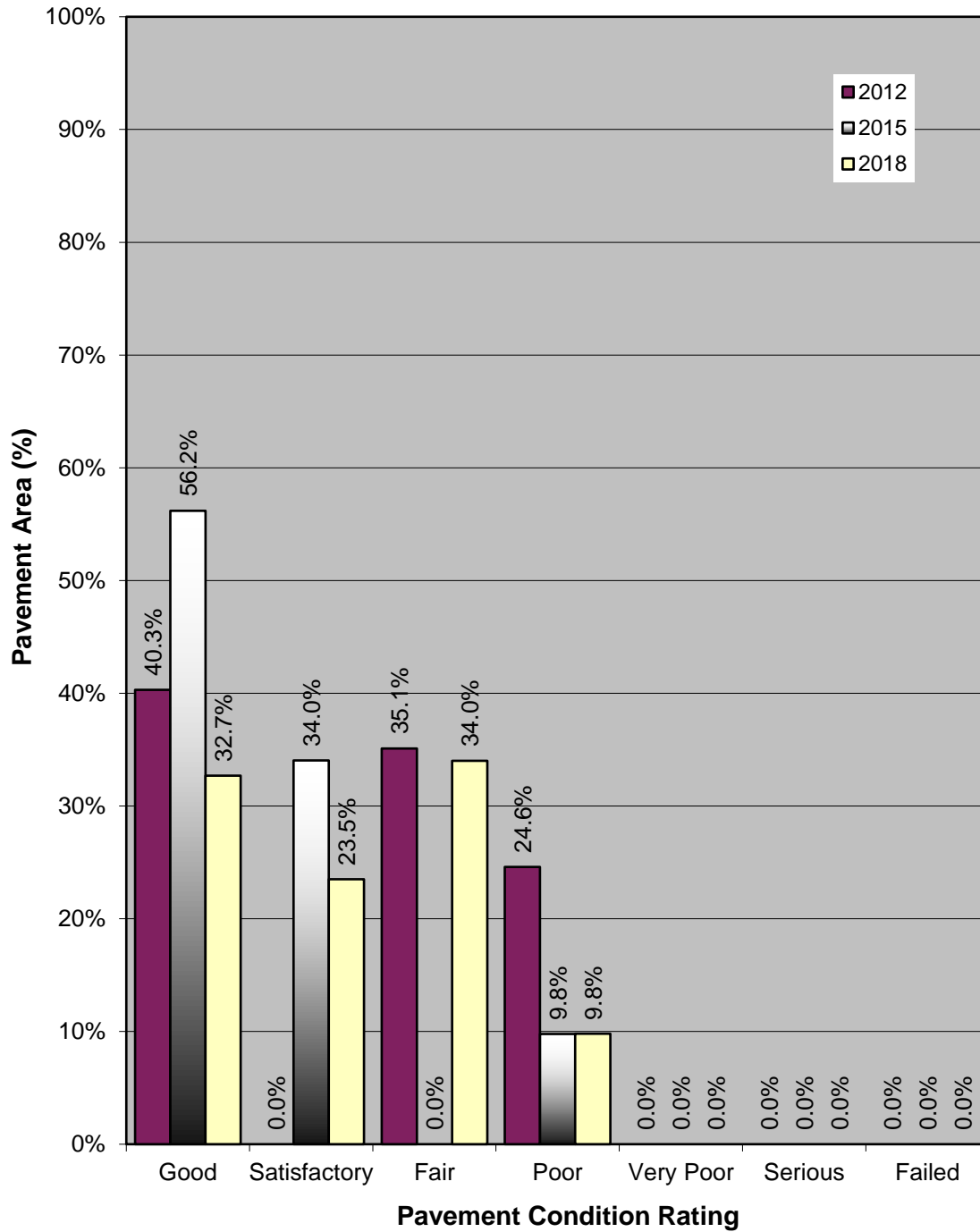

The primary distresses observed during the inspection were: longitudinal and transverse cracking, weathering and block cracking.

A graphical representation of the projected PCIs listed in Table 1 is shown in Figure SB-5.

RECOMMENDATIONS

Data collected during the visual condition survey were used by the PAVER software to generate the Network Maintenance Report contained in Appendix 3. This report identifies, for each pavement section, the recommended localized maintenance activities (i.e.-crack sealing, patching) that should be completed to repair the defects observed during the visual inspection. The repair quantities identified in the report were extrapolated to cover the entire pavement section, based on the distresses measured in the inspected sample units. If the repair activities identified are completed, the pavement deterioration rate will be slowed.

The recommended localized maintenance activities to be applied are selected by the PAVER software based on a Distress Maintenance Policy established for the Oregon airport system. The report results indicate that, over your entire airport, the following quantities of localized maintenance are needed:

- 16,301 linear feet of asphalt concrete crack sealing

The PAVER software can also identify and schedule recommended global (applied over an entire section) maintenance activities such as fog seals, slurry seals and other surface treatments, as well as major rehabilitation activities such as asphalt concrete overlays and complete reconstruction. PAVER schedules global maintenance on a user-defined interval. To schedule major rehabilitation PAVER uses pavement deterioration models developed during this project. These models are used to estimate future pavement condition and to schedule rehabilitation based on a trigger PCI.

During this project a 5-year program outlining recommended global maintenance and rehabilitation was developed. The program begins in the year 2019 to allow time for project development. These recommendations are presented in Table 2, which identifies the pavement section requiring rehabilitation, the year the action should be completed, the type of action, and an associated cost. This information is also presented graphically in Figure SB-6.

Predicted Condition in 2023.

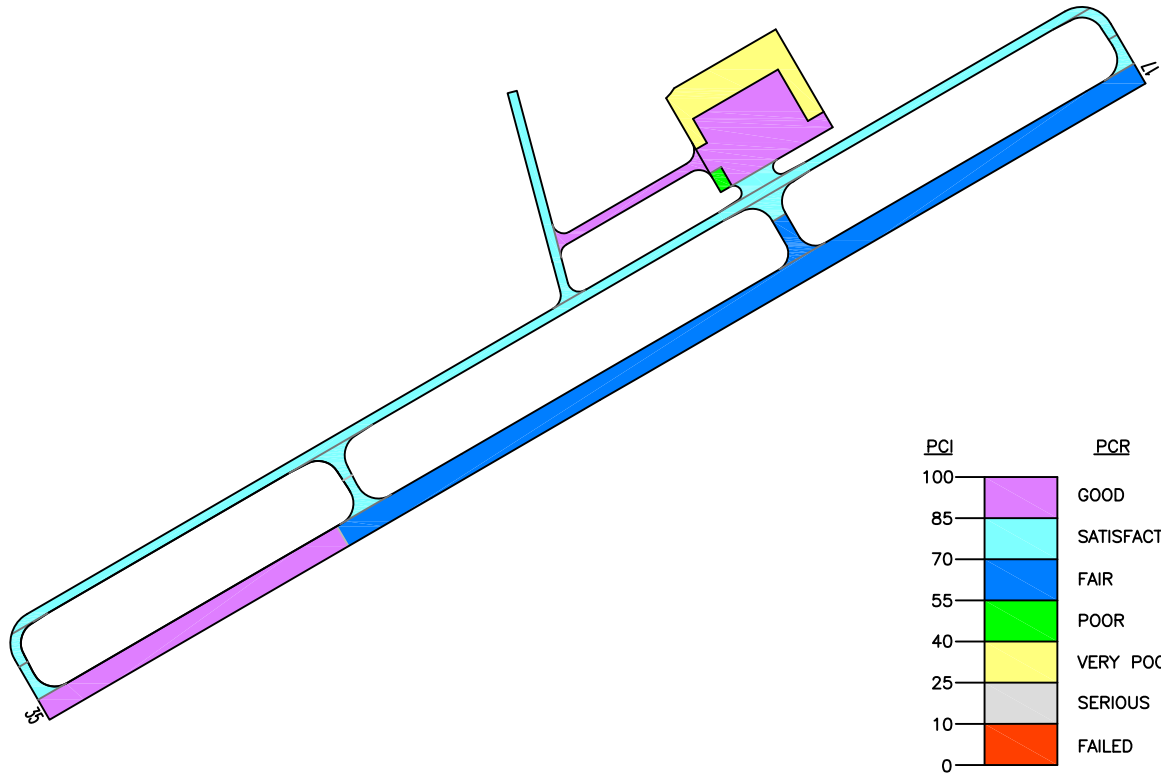

Predicted Condition in 2028.

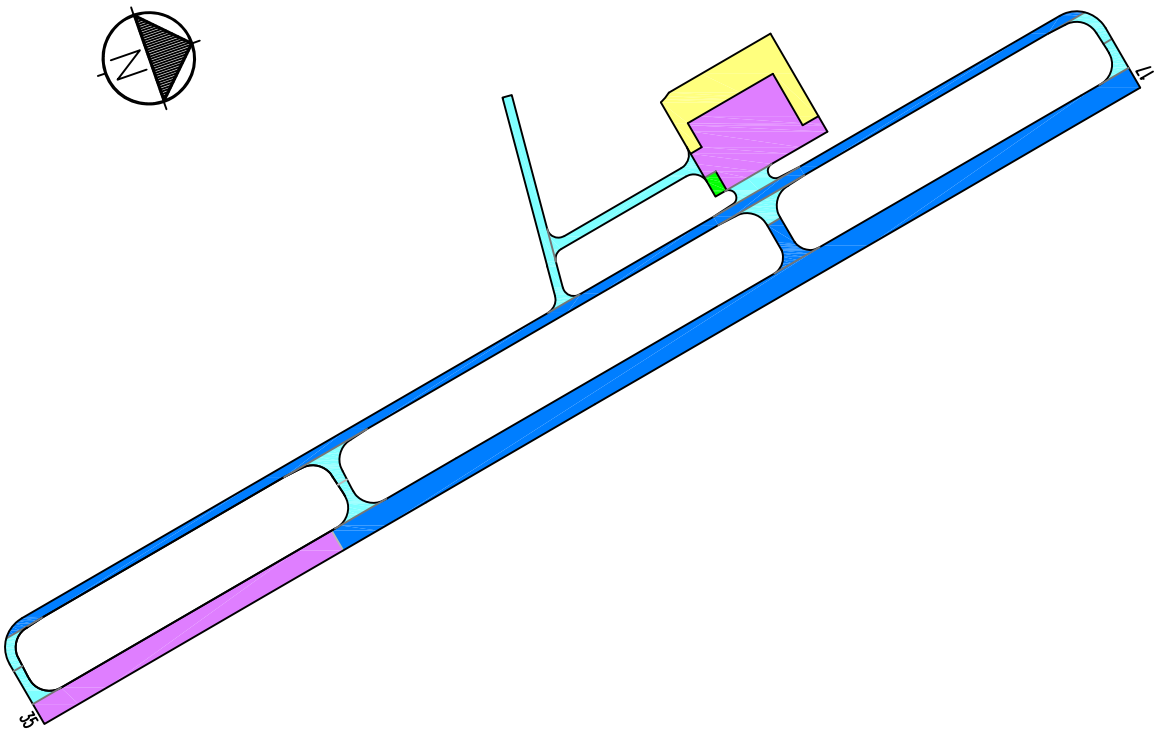

Drawing Date: September 2018

 PAVEMENT CONSULTANTS INC.

Figure SB-5. Future Pavement Condition.

Table 2. Five-Year Global Maintenance and Rehabilitation Plan.

Year	Branch	Section	Action	Area (sf)	Unit Cost (\$/sf)	Total Cost (\$)
2019	A01SB	01	2" AC Overlay	41,095	\$2.50	\$102,738
2019	A01SB	03	2" AC Overlay	1,893	\$2.50	\$4,733
2019	R17SB	02	Slurry Seal	144,000	\$0.31	\$44,640
2019	TA1SB	01	Slurry Seal	3,070	\$0.31	\$952
2019	TA1SB	02	Slurry Seal	2,936	\$0.31	\$910
2019	TA2SB	01	Slurry Seal	4,960	\$0.31	\$1,538
2019	TA2SB	02	Slurry Seal	4,532	\$0.31	\$1,405
2019	TA2SB	03	Slurry Seal	5,681	\$0.31	\$1,761
2019	TA3SB	01	Slurry Seal	4,559	\$0.31	\$1,413
2019	TA3SB	02	Slurry Seal	3,931	\$0.31	\$1,219
2019	TA4SB	01	Slurry Seal	2,761	\$0.31	\$856
2019	TA4SB	02	Slurry Seal	3,268	\$0.31	\$1,013
2019	TASB	01	Slurry Seal	80,233	\$0.31	\$24,872
2019 Total						\$188,049
2020	T01SB	02	Fog Seal	14,551	\$0.19	\$2,765
2020 Total						\$2,765
2023	T01SB	01	Fog Seal	12,020	\$0.19	\$2,284
2023 Total						\$2,284
5-Year Total						\$193,097

If the global maintenance and/or rehabilitation activities recommended in Table 2 are not completed, the localized maintenance activities identified in the Network Maintenance Report (Appendix 3) for that section should be done. Additionally, for those sections not listed in Table 2 as requiring global maintenance or rehabilitation, the localized maintenance activities outlined in the Network Maintenance Report should be completed. By completing the localized maintenance activities, pavement condition is improved, life is extended, deterioration is slowed and the length of time until major repair or rehabilitation is required is increased.

Figure SB-6. Five-Year Pavement Management Plan.
Siletz Bay State Airport

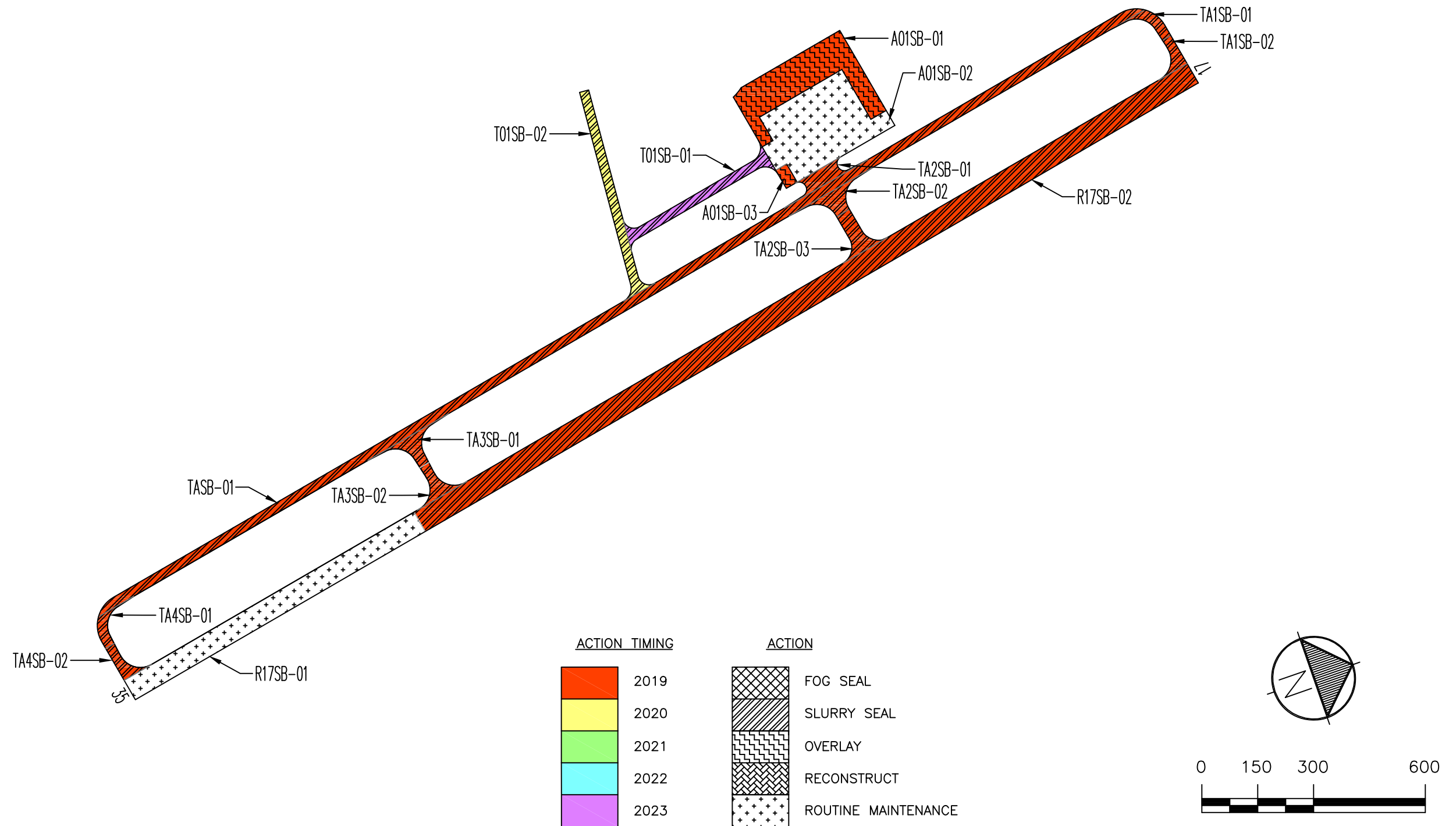

Drawing Date: September 2018

INSPECTION SCHEDULE

To comply with the inspection schedule requirement of FAA Grant Assurance Number 11, a detailed visual inspection should be conducted every 3 years using the methodology described in ASTM D5430. The next scheduled detailed visual inspection should take place in 2021.

In addition, the FAA requires that a drive-by inspection be conducted monthly to detect unforeseen changes in pavement condition. The results of each drive-by inspection should be recorded and kept in a file. At a minimum, the date of the inspection and an indication of any maintenance performed since the last drive-by inspection should be recorded.