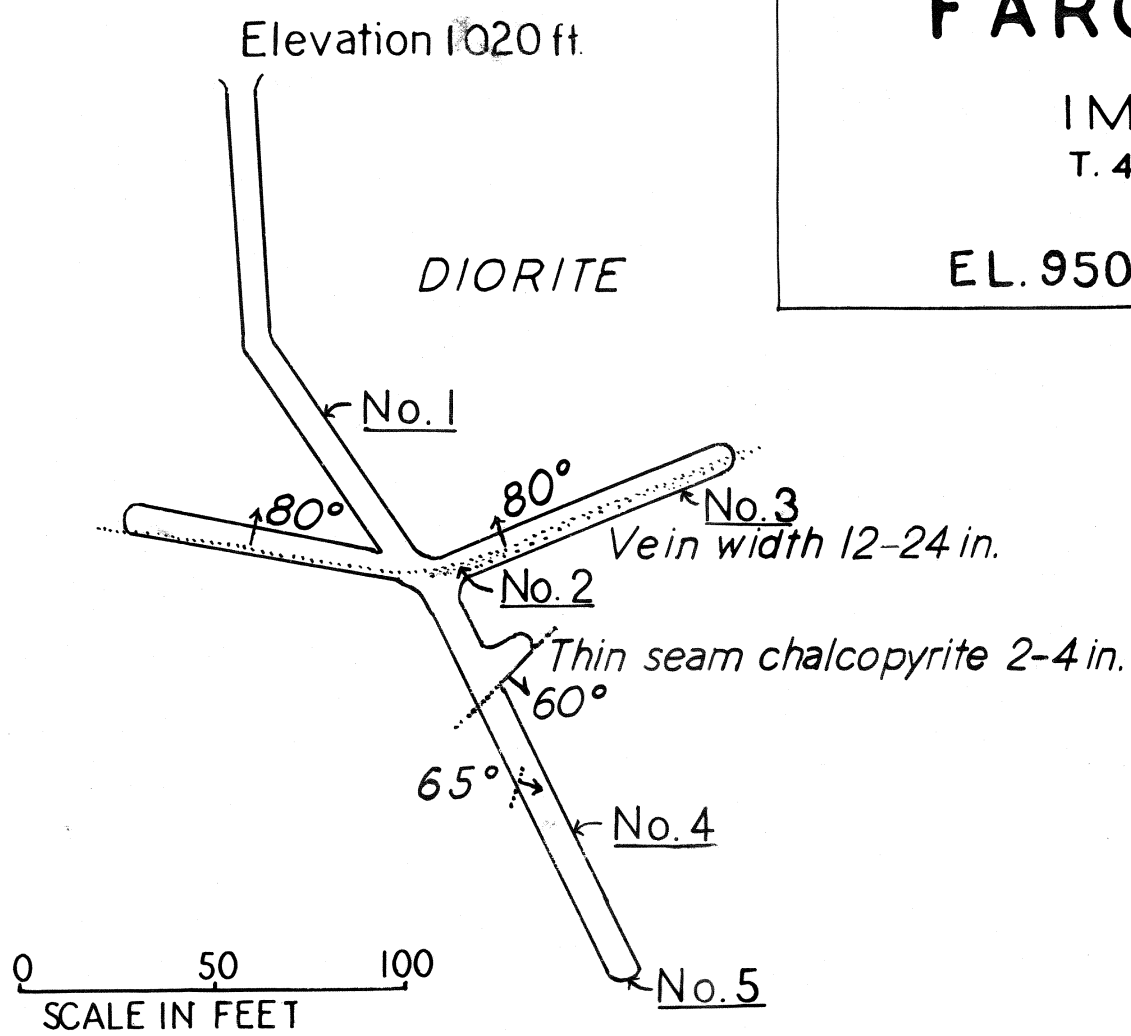

FIGURE 1



Snake River Chief Claim Discovery Tunnel

DEVELOPMENT WORK ON THE

FARGO GROUP OF MINING CLAIMS

IN AREA NEAR JUNCTION OF
IMNAHA AND SNAKE RIVERS
T. 4 N. - R. 49 E. WALLOWA CO. OREGON

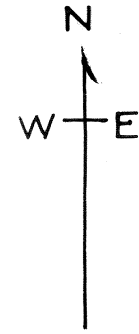

EL. 950 ft.

Sample No. 1 Vein- Fault-

FIGURE 4

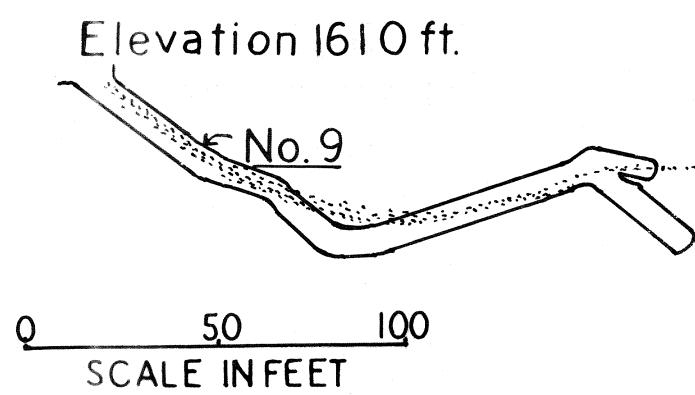

Last Chance Claim Discovery Tunnel

FIGURE 5

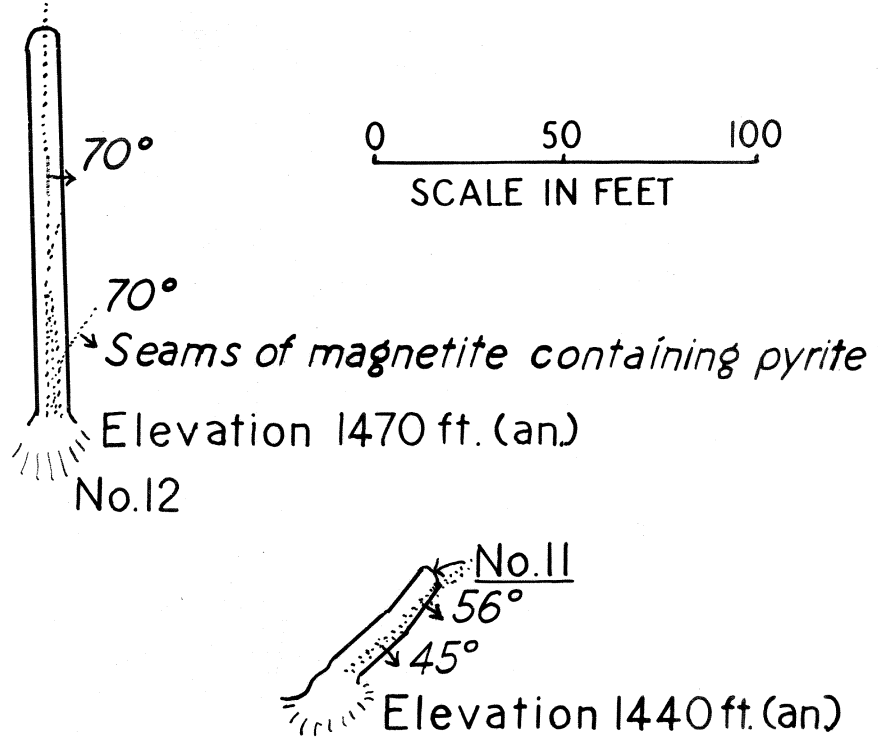

Iron King Claim Tunnels Southwest End

FIGURE 2

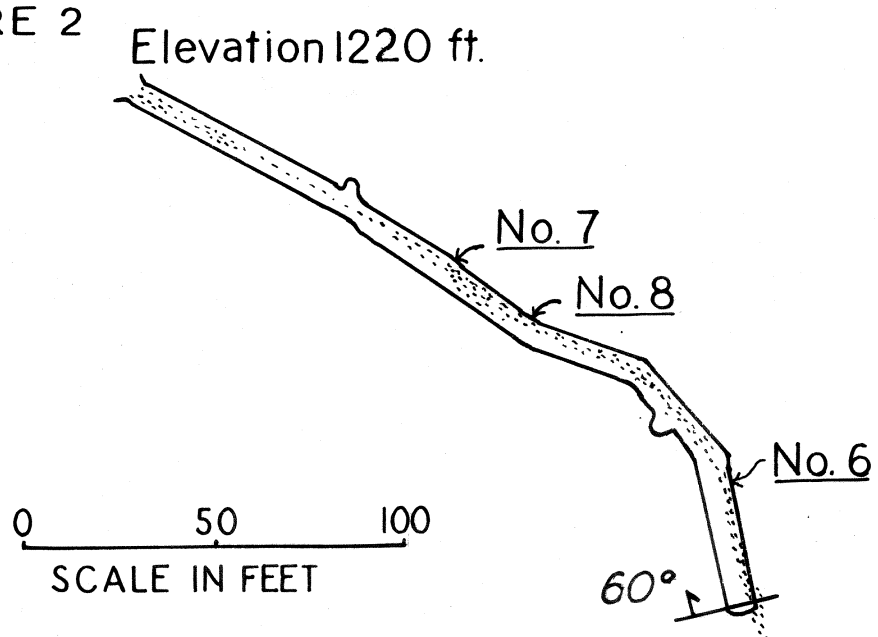

Snake River Chief Claim Tunnel Near East End

FIGURE 3

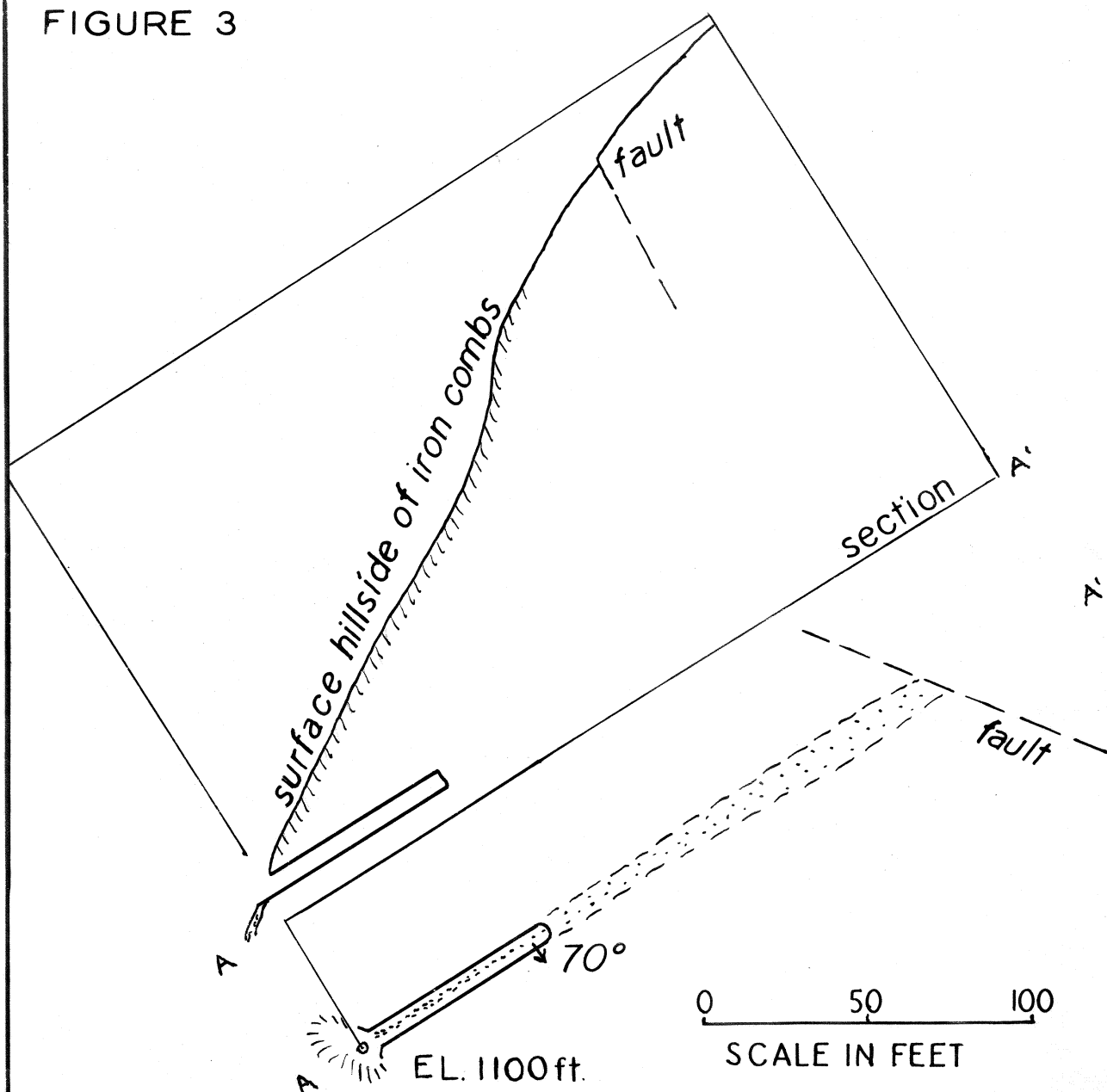

Snake River Chief Claim Tunnel and Iron Ribs

FIGURE 6

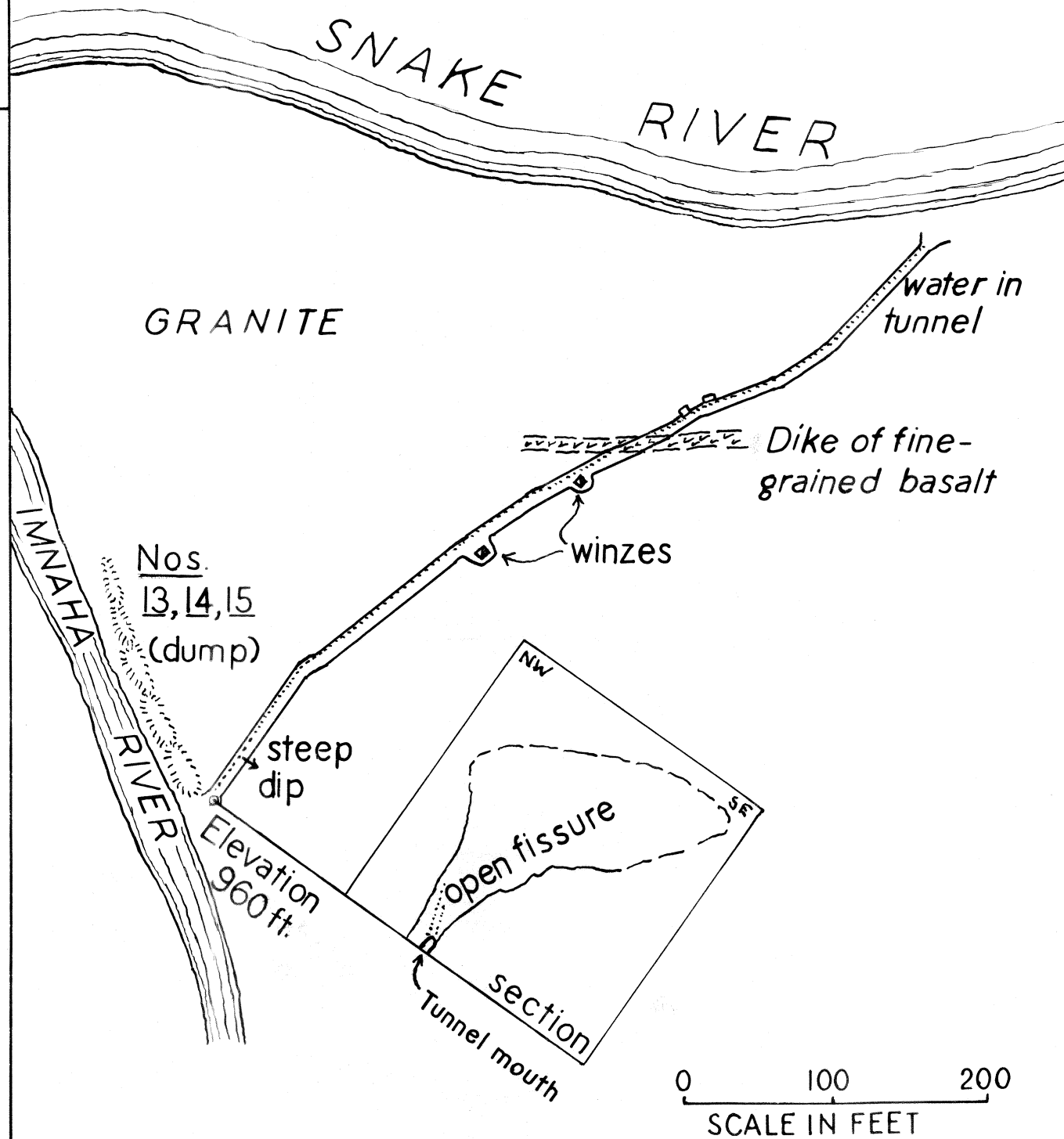

Mountain Chief Claim River to River Tunnel

Elev River 1500

No. 10?

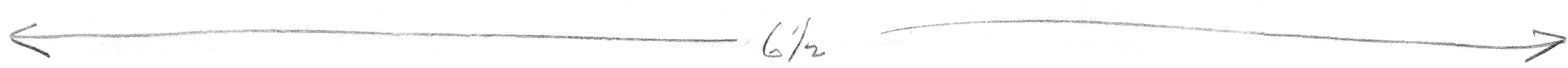

6 1/2

R103