



Oregon

Kate Brown, Governor

Department of Transportation
Construction Section
800 Airport Road SE
Salem, OR 97301-4792
Phone: (503) 986-3000
Fax: (503) 986-3096

December 1, 2020

To: All Holders of the Manual of Field Test Procedures

From: Chris M. Bucher, PE

Interim Construction and Materials Engineer

Subject: 2020 Revision of the Manual of Field Test Procedures

Enclosed is the 2020 revision to the Manual of Field Test Procedures. The revision package also includes a document providing a general list of the associated changes based on the layout of the Manual of Field Test Procedures. The revisions are based on comments from the Quality Assurance Steering Committee, Construction Training Coordinator, Quality Control Compliance Specialist's and industry material testing technicians.

The change package effects contracts advertised after this change date, any contract advertised prior to this change package falls under the appropriate MFTP change for that advertisement date. AASHTO test procedures are to be followed according to the latest MFTP change or the appropriate AASHTO test version to date. ODOT and WAQTC test procedures are in effect for the date the contract is advertised and may be modified to the new update change package through a Contract Change Order established by the Project Manager.

The following pages identify the appropriate add and remove sequence necessary to update the 2019 version of the MFTP. If an earlier version is being updated, then the appropriate update package will need to be applied before utilizing the enclosed documents.

MFTP 2020 Update

Summary of Changes

Introduction – No Changes

Section 1 – Test Procedures Index

This section was updated according to the test procedure date change, if applicable.

ODOT – Test Procedures

TM 759 (Static Modulus of Elasticity of Polymer Concrete Cylinders) – Section 00557, Premixed Polymer Concrete Overlays has been added to the New 2021 Standards Specifications. The Specification calls for the measurement of “Modulus of Elasticity”, which is determined according to TM 759. TM 759 is being added to the ODOT Test Procedure section and is also referenced in the acceptance guide.

AASHTO - Test Procedures

All of the FOP's for AASHTO test procedures have a revision date located in the upper right hand corner and a publishing date at the lower right hand corner. The publishing date will change each year, but the test procedure date only changes with major content related modifications, not grammatical or punctuation corrections.

Other AASHTO test procedures in this section are from the AASHTO organization and haven't been modified or reformatted.

T 22 (Compressive Strength of Cylindrical Concrete Specimens) – The following subsections have been modified:

- Section 5.2.1.1 – added the following: If required, the bottom bearing block may be fully supported by spacer blocks. One vertical center hole up (0.75 in.) in diameter is permissible. Space blocks shall not be in direct contact with the specimen or the retainers for un-bonded caps.
- Section 5.3.1 – Note 9, the English metric equivalent for 2 mm was corrected from 0.06 in. to 0.08 in. in two locations.
- Section 7 – Table 2 (Permissible Time Tolerances) the 12 h test age and permissible Tolerance of ± 0.25 h or 2.1% has been removed from the table. Also, tolerance percentages have been removed from the table and the following note added “For test ages not listed, the test age tolerance is ± 2.0 percent of the specified age”.
- Section 8 – added formulas for computing the compressive strength in SI or Inch-Pound Units.
- Section 8.3.1 – added formulas for computing cylinder density in SI or Inch-Pound Units.
- Section 8.3.2 – added a formula for computing the cylinder volume from submerged weighing.
- Section 9 – Added the following criteria for reporting:
 - Age of specimen at time of testing. Report age in days for ages three days or greater; report age in hours if the age is less than three days.

- Reformatted the “Types of Fracture” section and added 4 more diagrams of fracture type and defined each type.

T 27/11 (Sieve Analysis of Fine and Coarse Aggregates) – Under scope the AASHTO date version for T 27 and T 11 was changed to 2020.

Under procedure Method A the following bullets identify additions, deletions or modifications to the procedure:

- Below step 4, a new note 2 was added stating “Washing longer than 10 minutes with a mechanical washer has been shown to cause significant amounts of degradation depending upon aggregate type”.

This was determined by an AASHTO task force that studied the effects of prolonged mechanical washer usage.

- All subsequent notes have been renumbered, due to the note 2 insertion.
- Step 11, modified the first sentence to include a reference to Annex B “Overload Determination”.
- Step 12, removed the term “washed” from the sentence. Step 10 already indicates the sample was washed, so this was a redundant reference.

Method B

- The mentioned changes under Method A were also applied to Method B.
- Step 17, the Annex B “Overload Determination” reference was added.

Method C

- Step 3, modified the first sentence to include a reference to Annex B “Overload Determination”.
- Below step 12, a new note 4 was added stating “Washing longer than 10 minutes with a mechanical washer has been shown to cause significant amounts of degradation depending upon aggregate type”.
- Step 19, modified the first sentence to include a reference to Annex B “Overload Determination”.
- Step 20, removed the term “washed” from the sentence. Step 18, already indicated the sample was washed, so this redundant reference was removed.
- Under Annex A and B, added the Phrase (Mandatory Information) under the Time Evaluation and Overload Determination sub titles.

Minor formatting and editorial items were also addressed.

T 30 (Mechanical Analysis of Extracted Aggregates) – Under Annex A and B, added the Phrase (Mandatory Information) under the Time Evaluation and Overload Determination sub titles.

Minor formatting and editorial items were also addressed.

- ❖ **T 30 (Yellow Sheet)** – Removed the step 1 reference from the first bullet. This was a carry-over reference from the 2016 version that is no longer applicable.

T 85 (Specific Gravity and Absorption of Coarse Aggregate) – The following bullets identify additions, deletions or modifications to the procedure:

- Under the Apparatus section, first bullet “Balance or Scale”, changed the scale sensitivity from 1 g to 0.1 g.
- Under the Sample Preparation section, step 5 was modified to include the T 255/265 reference for drying the sample to constant mass.
- Under Procedure, step 7, added a temperature reference ($110 \pm 5^{\circ}\text{C}$ ($230 \pm 9^{\circ}\text{F}$)) for drying the sample after SSD mass determination.
- Under Procedure, step 7, removed the existing phrase “Designate this mass as “A” and created a new step 8 to include this phrase and state “Determine and record the dry mass”.

Minor formatting, spelling and editorial items were also addressed.

T 99/180 (Moisture-Density Relations of Soils) – The following bullets identify additions, deletions or modifications to the procedure:

- Under the Scope section, updated the AASHTO reference date to 2020.
- Under Procedure, step 9, added the (rho) variable ρ_w after the wet density.
- Under the Calculation Section for Wet Density and Dry Density, replaced D_w with the (rho) variable ρ_w and replaced D_d with the (rho) variable ρ_d , both of these references have been corrected throughout the rest of the calculation section.
- Under Annex A, added the phrase (Mandatory Information) and above step 1 added the sub-title “Procedure”.
- Under Annex A, Density Correction Equation, replaced the variable D_d with the (rho) variable ρ_d throughout the calculation and example section.
- Under Annex B, added the phrase (Mandatory Information).
- Under Annex B, Calculations, added the (rho) variable for the density of water (ρ_{water}).

Minor formatting and editorial items were also addressed.

T 121 (Density (Unit Weight), Yield, and Air Content (Gravimetric) of Concrete) – The following bullets identify additions, deletions or modifications to the procedure:

- Under the Scope updated the AASHTO reference to 2019.
- Under the Apparatus section, 4th bullet “Vibrator” added the term “longer” to describe the length of the shaft in relation to the section being vibrated.
- Removed the sampling language from the Procedure Section, Rodding, and created a new section “Sampling”. The sampling language is now in its own section and references the entire procedure.

Rodding

- Under Procedure, removed step 14 thru 17, striking the measure surface, cleaning of the rim, recording the mass etc. and placed in a new established section “Strike-off and Determining Mass”. This new format will be used for each option; rodding, internal vibration and SCC.
- Added a step 13, to reference the new “Strike-off and Determining Mass” section.
- Removed step 17, the existing language related to air-content determination is now located under the “Strike-off and Determining Mass” section.

Internal Vibration

- Removed existing step 1. Added a new step 1, determine and record mass of empty measure and new step 2 dampen the insides of the measure and empty excess water.
- Added a step 9 language to ensure the measure is full 1/8” above the rim. Adjustment of the concrete can be made if the measure is under full; only after final consolidation.
- Added a step 10 “Continue with ‘Strike-off and Determining Mass’”.

Self-Consolidating Concrete

- Removed the existing step 1 referencing the Rodding section. Added a new step 1, determine and record mass of empty measure and step 2 dampen the inside of the measure and empty excess water.
- A new section was created “Strike-off and Determining Mass”. This new section now contains all of the steps to strike-off the measure and determine the mass. This section also references the air-content determination, if applicable.
- Under Annex A, added the phrase (Mandatory Information).

Minor formatting and editorial items were also addressed.

T 152 (Air Content of Freshly Mixed Concrete by the Pressure Method) – The following bullets identify additions, deletions or modifications to the procedure:

- Removed the sampling language from the Procedure Section, Rodding, and created a new section “Sampling”. The sampling language is now in its own section and references the entire procedure.

Rodding

- Under Procedure, removed steps 13 thru 27, striking the measure surface, cleaning of the rim, recording the mass etc. and placed in a new established section “Strike-off and Air Content”. Removed all of the procedural steps for placing the lid on the measure, removing the internal air through water addition and making final adjustments prior to air content measurement and reading. These steps are now located under the new established section ‘Strike-off and Air Content’.

Internal Vibration

- Removed step 1, sampling, this language is now located under the new section “Sampling”.
- Renumbered steps and added “Continue with ‘Strike-off and Air Content’ as new step 8 language. The existing step 9 language, returning the user to the Rodding section, has been removed.

Self-Consolidating Concrete

- Removed step 1, sampling, this language is now located under the new section “Sampling”.
- A new section was created “Strike-off and Air Content”. This new section now contains all of the steps to strike-off the measure and complete the air content determination.
- Under Annex A, added the phrase (Mandatory Information).

Minor formatting and editorial items were also addressed.

- ❖ **T 152 (Yellow Sheet)** – Second bullet, first sentence was deleted and replaced with the following: Under Sampling, step 1, second sentence, delete 1 ½” and replace with 2”. Deleted the third bullet. This reference has been removed from the internal vibration section of the procedure and the wet sieving language for 1 ½” aggregate is only located under the sampling section of the procedure.

T 166 (Bulk Specific Gravity of Compacted Asphalt Mixtures Using Saturated Surface-Dry Specimens) – The following bullets identify additions, deletions or modifications to the procedure:

- Under Test Specimens section, added the word “sampled” after “or” to correct the sentence structure. Also, removed the sentence below the first paragraph that indicated samples removed from the pavement “will” be sampled according to AASHTO R 67. ODOT TM 327 references core removal according to AASHTO R 67, so the deletion has no impact on the QA program.
- Under Procedure (Method A, Suspension) 1-b, removed step references i thru vii. Now step 1-b, reads “Vacuum dry method according to the FOP for AASHTO R 79”.
- Under the Calculations for (Method A, Suspension), added givens for the example.
- Under Procedure (Method B, Volumeter) 1-b, removed step references i thru vii. Now step 1-b, reads “Vacuum dry method according to the FOP for AASHTO R 79.”
- Under the Calculations for (Method B, Volumeter), added givens for the example.

Minor formatting and editorial items were also addressed.

T 176 (Plastic Fines in Graded Aggregates and Soils by the use of the Sand Equivalent Test) – Under the “Sample Preparation” section, step 2, modified the existing sentence to read “Sieve the sample over the 4.75 mm (No. 4) sieve.”

Minor formatting, spelling and grammar items were also addressed.

T 209 (Theoretical Maximum Specific Gravity of HMA) – The following bullets identify additions, deletions or modifications to the procedure:

- Under the Scope the AASHTO reference date has been changed to 2020.

Apparatus

- First bullet, added the scale must meet the requirements of AASHTO M231, Class G2.
- Second bullet, modified the sentence to state the “container” must be able to withstand the pressure of a full vacuum and not a partial vacuum.
- Sixth bullet, added “Vacuum measurement device” to the beginning of the sentence and added the manometer or vacuum gauge must be accurate to 0.1 kPa (1 mm Hg).
- Eighth bullet, clarified the water bath is (optional for Pycnometer or Volumetric Flask Method).
- Ninth bullet, thermometers, removed the existing statement “Standardized liquid in glass, or electronic digital total immersion type” and stated “Thermometric devices”.
- Added an additional item to the apparatus list “Towel”.

Procedure

- Modified the Standardization of Pycnometer or Volumetric Flask section to reference a new established Annex A, which now provides steps for the Standardization process.
- Under the Test Sample Preparation section, step 2, clarified that if two or more samples are run the results will be combined by calculating a weighted average.
- Under the Procedure section, changed the term “content” to “sample” throughout the test procedure.
- Under the Procedure section, Bowl, removed steps 16A thru 18A. Determination of the bowl weight in water is now under Annex A “Standardization”.
- Under the Calculation section, Bowl Procedure, modified the G_{mm} formula to account for the standardized submerged weight of the bowl.
- Under the Calculation section, added the formula and example for the “Weighted Average” calculation.
- Added a new Annex A “Standardization of Bowl and Pycnometer or Volumetric Flask”. This section provides steps to standardize the Bowl and Pycnometer or Volumetric Flask for initial use. This section also includes a check of the Standardization value for the Bowl, Pycnometer or Volumetric Flask in the event test results become questionable or verification of the Standardization value is required by the agency.

Minor formatting and editorial items were also addressed.

❖ **T 209 (Yellow Sheet)** – the following bullets identify additions, deletions or modifications to the yellow sheet entries:

- Deleted the second bullet and added the following: Under the Standardization Section, delete the second sentence and add the following: The container shall be standardized annually and when the calibration value is in question. The existing standardization frequency was deleted and the new procedure frequency will be followed (see new Annex A for details).

- Under the sixth bullet, removed the last sentence. The R=1.0000 reference is no longer applicable.

T 255/265 (Total Evaporable Moisture Content of Aggregate by Drying and Laboratory Determination of Moisture Content of Soils) – The following bullets identify additions, deletions or modifications to the procedure:

- Under Procedure, step 4, added the variable M_w to designate wet mass of sample.
- Under Procedure, step 16, added the variable M_d to designate dry mass of sample.
- Under the Calculation section, Constant Mass, removed the term “dry” from the example expressions. The sample is being evaluated for a dry state, so the term “dry” isn’t appropriate.

Minor formatting and editorial items were addressed.

T 308 (Determining the Asphalt Binder Content of HMA by Ignition Method)

The following bullets identify additions, deletions or modifications to the procedure:

- Under Procedure, Method A (Internal Balance), a step was added to verify the furnace scale is reading zero, if not, reset to zero. The rest of steps were renumbered to reference this addition.
- Under Procedure, Method A (Internal Balance), new step 14, modified the existing second sentence to state if the moisture content and correction factor aren’t entered into the furnace controller they will need to be deducted from the printed ticket to accurately compute Asphalt Binder content percentage.
- Under Annex – Correction Factors, the third paragraph was removed that referenced the use of historical data or scientific studies may be used to determine correction factor(s) in lieu of using the correction procedure.

With ongoing change of ACP constituents e.g. RAP, binder and aggregate sources, it would be extremely difficult to utilize historical data and accurately determine asphalt binder content and aggregate gradations. All of the WAQTC member states, including Oregon, require annual calibrations of the ignition furnaces. This change is also being recommended to AASHTO for removal.

Minor formatting and editorial items were also addressed.

T 309 (Temperature of Freshly Mixed Portland Cement Concrete) - The following bullets identify additions, deletions or modifications to the procedure:

- Under the Scope the AASHTO reference date has been changed to 2020.
- Under Sample Locations and Times, removed the third paragraph referencing temperature measurement of concrete with large nominal size aggregate (greater than 3”). The AASHTO Standard has moved this language from the procedural section to the “Significance and Use” section of the document, so it’s no longer part of the required steps, the committee recommended its removal from the FOP.

Minor formatting and editorial items were also addressed.

T 310 (In-Place Density and Moisture Content of Soil and Soil Aggregate by Nuclear Methods) – The following bullets identify additions, deletions or modifications to the procedure:

- Throughout the procedure all references to the term “probe” have been replaced with the term “source rod”. Some areas of the procedure referenced source rod, while other sections referenced probe, so this change creates consistency throughout the document and is the term commonly used by gauge manufacturers.

Minor formatting and editorial items were also addressed.

T 324 (Hamburg Wheel-Track Testing of Compacted Asphalt Mixtures) – This is a new procedure for mix design verification and long term performance measurement. T 283 (TSR) will still be utilized until the Hamburg test can be fully implemented.

T 329 (Moisture Content of Asphalt Mixtures by Oven Method) – The following bullets identify additions, deletions or modifications to the procedure:

- Under Procedure, note 1 has been removed and subsequent notes renumbered. Comparison or repeatability testing between labs isn't a requirement of the procedure or for its intended use.

Minor formatting and editorial items were also addressed.

T 355 (In-place Density of Asphalt Mixtures by Nuclear Method) – The following bullets identify additions, deletions or modifications to the procedure:

- Throughout the procedure all references to the term “probe” have been replaced with the term “source rod”. Some areas of the procedure referenced source rod, while other sections referenced probe, so this change creates consistency throughout the document and is the term commonly used by gauge manufacturers.

Minor formatting and editorial items were also addressed.

❖ **R 47 (Yellow Sheet for Reducing Samples of Asphalt Mixtures to Testing Size)** – First bullet, removed the Type A (Quartermaster) reference. The Quartermaster is no longer referenced in the procedure.

R 67 (Sampling Asphalt Mixtures after Compaction (Obtaining Cores)) – The following bullets identify additions, deletions or modifications to the procedure:

- Procedural date updated to 2020 (R 67-20).
- Added a new section (Referenced Document) and included ASTM D3549 (Standard Test Method for Thickness or Height of Compacted Asphalt Mixture Specimen). All subsequent sections were also renumbered.
- Under the Procedure section, the sentence stating “to accelerate the coring process, compacted asphalt samples may be cooled to expedite the core removal using, water, ice, dry ice, or liquid nitrogen” was converted into a note. All subsequent notes have been renumbered.

- Under Procedure section, step 5.6, added language stating “remove loose particles adhering to the core by brushing or washing specimen”. Also, added “embedded granular material should be carefully removed from cores taken over aggregate base”.
- Under Packaging and Transporting Samples section, step 6.3 added “to prevent breaking or deforming” to the end of the existing sentence. Now the sentence reads “prevent cores from freezing or from excessive heat during transport to prevent breaking or deforming”.
- A new Appendixes (Non-mandatory Information) has been added, Procedure to Remove Cut Aggregates from Asphalt Pavement Cores for Laboratory Testing. If gradation of the existing core sample is desired, this section provides a means to remove any cut aggregate that occurred during the coring process.

Minor formatting and editorial items were also addressed.

❖ **R 67 (Yellow Sheet)** – the following bullets identify additions, deletions or modifications to the yellow sheet entries:

- The Apparatus section has been changed from 3 to 4, based on the procedural addition of “Reference Document” section.
- The first bullet has been changed from section reference 3.2 to 4.2.
- The second bullet has been changed from section reference 3.3 to 4.3.
- The third bullet has been changed from section reference 3.4 to 4.4.
- Deleted the last section referencing “Filling Core Holes” and replaced with the following: Under Procedure, step 5.8 delete and replace with the following: “The Hole created from the coring operation shall be filled with fast setting non-shrink grout from the QPL (Qualified Product List). Set time shall be less than 20 minutes. Ensure that the final surface is flush with the surrounding surface”.
- Under Layer Separation, changed the section reference from section 6 (step 6.1) to section 7 (step 7.1).

R 76 (Reducing Samples of Aggregates to Testing Size) – The following bullets identify additions, deletions or modifications to the procedure:

- Under the Apparatus section, Method B – Quartering, third bullet, removed the dimension statement (6 by 9 ft.) and added “appropriate for the amount and size of the material being reduced”.
- Under Procedure, Method A – Mechanical Splitter, the existing paragraphs were reduced into procedural steps and reworded.
- The existing splitter bias formula and example was given a new section title “Mechanical Splitter Check”.
- Added a new section “Alternative to Mechanical Splitter Check”, so technicians can waive the calculation check and either combine a heavy pan with a light pan or simply swap pans during the reduction phase (See Figure 1 and 2 for an illustration).

Minor formatting and editorial items were also addressed.

R 90 (Sampling of Aggregate Products) – The following bullets identify additions, deletions or modifications to the procedure:

- Under Table 1, Note 1, third sentence changed the existing T 27/11 table reference from 2 to 1.
- Deleted Note 3, stating “obtain samples at stockpiles should be avoided whenever possible due to problems involved in obtaining a representative gradation of material”. This statement isn’t part of the AASHTO Standard and contradicts the test procedure, which has an allowance for sampling from the stockpile.

Minor formatting and editorial items were also addressed.

❖ **R 90 (Yellow Sheet)** – Removed existing bullet, which referenced note 3, under Stockpiles. This note has been removed from the procedure.

R 97 (Sampling of Asphalt Mixtures) – The following bullets identify additions, deletions or modifications to the procedure:

- Under the Scope, added a safety statement to cover all of the sampling methods in the procedure.
- Under Procedure, Windrow Method, added labels to both windrow figures.

Minor formatting and editorial items were also addressed.

WAQTC Test Procedures

TM 2 (Sampling Freshly Mixed Concrete) – The following bullets identify additions, deletions or modifications to the procedure:

- Under Apparatus, added a bullet to define Receptacle, as a wheelbarrow, bucket or other suitable container that does not alter the properties of the material being sampled.
- Throughout the Procedure, all references to “sample container” have been changed to “receptacle”.

Minor formatting and editorial items were also addressed.

Section 2 QA Program

Section I, Overview – No Changes

Section II, Roles and Responsibilities – No Changes

Lab Certification Program – No Changes

Technician Certification Program – No Changes

Section VI, Product Specific QC/QA Testing Plan – No Changes

- **Table 1 IA parameters** – No Changes

Appendix A, ODOT Approved Commercial Aggregate Product Program – No Changes

Appendix B, Contractor Quality Control Plan – No Changes

Appendix C, Troubleshooting Guide – No Changes

Section 3 Report Forms and Examples

Forms Index and Introduction – in the form index added a new form 734-5292 for Mechanical Anchors under the subcategory Miscellaneous.

Forms Description of Worksheet and Calculation Explanations – No Changes

The following forms have been modified:

734-1793 S (Nuclear Compaction Test Report for Soils) – Replaced the Df variable with the row variable pf representing the density of the fines in all applicable form fields.

734-3468 (Maximum Density of Construction Materials) – Replaced the Df variable with the row variable pf representing the density of the fines in all applicable form fields.

734-3468 B (Maximum Density of Aggregate Base Materials) – Replaced the Df variable with the row variable pf representing the density of the fines in all applicable form fields.

734-2327 IC (ACP Incinerator Oven Calibration Worksheet) – A spelling error was corrected regarding the term sieve.

734-5292 (Mechanical Anchor Pull Test) – Added a new form for Mechanical Anchor Pull Testing (Demonstration and Production) for Specification Section 00535, which now includes Mechanical Anchor's.

Section 4A Product Compliance – No Changes

Section 4(B) Small Quantity Guidelines – No Changes

Section 4(C) Laboratory Samples - No Changes

Section 4D Acceptance Guide

How to Use the Field Tested Materials Acceptance Guide – No Changes

Types of Tests – No Changes

Acceptance Guide Section 4D – The following specification sections were modified, updated or deleted:

- The revision date has been updated to 2020, due to multiple modifications in the document.
- Section 00535, Post-Installed Anchor Systems, added Mechanical Anchor's and the appropriate testing frequency. The specification has been changed to now include Resin Bonded Anchor's and Mechanical Anchors under the new of "Post-Installed Anchor Systems".

- Section 00557, Premixed Polymer Concrete Overlays, this a new Standard Specification addition that was currently only referenced in contract Special Provisions. Aggregate, Surface Texture Material, Trial Strip and Polymer Concrete testing and frequencies have been created. ODOT TM 759 (Modulus of Elasticity) will be added to the MFTP to supplement this new specification.
- Section 00559, Structural Concrete Overlays, is a new Standard Specification addition and replaces the existing Silica Fume and Latex Modified Concrete Overlay section. The existing 00559 aggregate and concrete testing frequencies have been retained, but the title of the section has been changed.

Also, the existing 00559.10 references will be removed, they are no longer applicable under the new specification.

- Section 00590, Polymer Membrane, is a new Standard Specification addition. Only moisture content testing is required from a material testing perspective for packaging of the Broadcast Aggregate and at time of mixing with the Polymer Resin.
- Section 00596A, Mechanically Stabilized Earth Retaining Walls, the 02690 sub-section references have been corrected due to changes in section 02690.
- Section 00596B, Prefabricated Modular Retaining Walls, the 02960 sub-section references have been corrected due to changes in section 02690.
- Section 00743, Porous Asphalt Concrete (PAC), added a reference that TM 323 Calibration Incinerator Samples are required to be submitted a minimum of 2 days prior to ACP production.
- Section 00744, Porous Asphalt Concrete (PAC), added a reference that TM 323 Calibration Incinerator Samples are required to be submitted a minimum of 2 days prior to ACP production.
- Section 00745, Porous Asphalt Concrete (PAC), added a reference that TM 323 Calibration Incinerator Samples are required to be submitted a minimum of 2 days prior to ACP production.
- Section(s) 00754, 00755, 00756, 00758, Concrete Pavement and Repairs, changed the Smoothness reference from “Determining Profile Index (TM770)” to “Determining IRI with an Inertial Laser Profiler (TM 772)”.

Section 5 Type D & E Acceptance Guide – The same changes in section 4D will be made to this section, if applicable.

Sean P. Parker 
 Senior Quality Assurance Specialist
 ODOT Construction, Quality Assurance

INSERT TAB

Introduction

Oregon Department of Transportation

Manual of Field Test Procedures

INTRODUCTION

PURPOSE

This manual is designed to be used by Contractor and Agency technicians for the sampling and testing of construction materials, and to determine their conformance to ODOT specifications. Included herein are the Test Procedures, the Quality Assurance Program, report forms and examples, and the Field Tested Materials Acceptance Guide, to be used by field personnel for guidance, reference and instruction.

FORMAT

This Manual is divided into four main sub-sections:

- (1) Test Procedures
- (2) Quality Assurance Program
- (3) Report Forms and Examples
- (4) Field Tested Materials Acceptance Guide

The process control and acceptance test procedures in this manual are to be used for testing construction materials on ODOT projects. English and Metric unit designations are not direct conversions, use the appropriate designation identified by the Project contract documents.

Test results and supporting data shall conform to the following rounding convention, based on the significant digit requirement of the contract specifications or test procedure reporting criteria.

- The final significant digit will not be changed when the succeeding digit is less than 5.
- The final significant digit will be increased by one when the succeeding digit is 5 or greater.

All field test procedures in this manual have ODOT, AASHTO or WAQTC references. Some field test procedures have been written as Field Operating Procedures, e.g., "FOP for AASHTO T-". FOP's conform to the approved AASHTO or other test methods, but may eliminate some of the verbiage and/or combine several test methods to help reduce testing time. If there is a conflict between the FOP and the AASHTO test procedure due to errors or omissions, the AASHTO test procedure will hold precedence over the FOP. The yellow sheet addendums included with the FOP's are utilized to identify preferred methods or modifications observed by the Oregon Department of Transportation.

HOW TO USE THIS MANUAL

This *Manual of Field Test Procedures* is used in conjunction with the contract plans, specifications, and the Construction Manual. It defines the requirements of ODOT's Quality Assurance Program.

The sampling and testing requirements and test procedures for most work items can be found in this Manual. Testing requirements for other materials will be specified in the contract plans and specifications.

Section 1 - Test Procedures: This section includes procedures for all regular field test procedures required by the ODOT specifications.

Section 2 - Quality Assurance Program: This section includes ODOT's Quality Assurance Program Manual, which includes the Technician Certification and Laboratory Certification programs. It also includes information on Independent Assurance parameters, random sampling, sampling programs at commercial aggregate sources, and verifying Contractor Quality Control test results.

Section 3 - Report Forms and Examples: This section includes copies of ODOT forms that are used to submit samples to ODOT's Central Materials Laboratory (ODOT-CML), and forms that can be used for field test results. It also includes completed examples of the forms and instructions for obtaining electronic versions of the forms.

Section 4:

Subsection A – Source Review/Product Compliance Testing Requirements: This subsection describes the testing requirements and frequencies for raw and processed aggregate material. Specific test requirements are included in the Field Tested Materials Acceptance Guide (FTMAG) in subsection 4(D).

Subsection B - Small Quantity Schedule: This subsection describes the criteria under which small amounts of materials can be accepted, without testing, upon satisfaction of the stated criteria.

Subsection C – Material Sampling Requirements: This subsection provides the requirements for sample sizes, types of containers, labeling, and other necessary information for samples that will be sent to the ODOT-CML or other laboratories for testing.

Subsection D - Field Tested Materials Acceptance Guide: This subsection lists the required tests that are to be performed for construction materials. It also outlines the frequencies at which the tests shall be performed, and the certified technician who shall perform them. The Definition of Visual field acceptance at the Project Managers level is also defined in this section.

ACRONYMS AND DEFINITIONS

Following are common acronyms and definitions found in this manual. Other acronyms and definitions may be found in Section 00110 of the Standard Specifications.

AASHTO - The American Association of State Highway and Transportation Officials

ACP - Asphalt Concrete Pavement, refers to either hot mix or warm mix asphalt concrete

ASTM - The American Society for Testing and Materials

ODOT-CML - The ODOT Central Materials Laboratory located at 800 Airport Road SE in Salem

Certified Laboratory - A Quality Control or Quality Assurance laboratory that possesses a valid certification, as described in Section 2 (Quality Assurance Program), issued by the ODOT-CML indicating that the laboratory had proper, calibrated equipment at the time of the inspection.

Certified Technician - A technician who is certified to perform a specific material test(s) and who possesses a valid certification, as described in Section 2 (Quality Assurance Program), issued by the ODOT-CML. The certification indicates their knowledge of, and ability to perform, the required test procedures, and to correctly prepare the test reports.

CGC - Commercial Grade Concrete (MSC – Minor Structure Concrete)

CAC - Certification Advisory Committee See Section 2 (Quality Assurance Program)

Density of Water - (62.4 lbs/ft³ (1000) kg/m³). Use the test procedure temperature correction table for AASHTO test method T 121.

Dispute Resolution Laboratory – Used for Third Party Testing, See Section 2 Quality Assurance Program for more details.

EAC - Emulsified Asphalt Concrete

FHWA - The Federal Highway Administration

FOP - Field Operating Procedure. FOP's conform to approved test methods, but may eliminate some of the verbiage and/or combine several test methods to reduce testing time.

FTMAG – Field Tested Materials Acceptance Guide. See Section 4D

HMAC - Hot Mixed Asphalt Concrete or HMA (Hot Mixed Asphalt)

IA - Independent Assurance. See Section 2 (Quality Assurance Program)

JMF - Job Mix Formula for asphalt concrete

MDT – Maximum Density Test (Use 62.4 lbs/ft³ (1000) kg/m³ for unit conversion)

MSE – Mechanically Stabilized Earth

MFTP - Manual of Field Test Procedures (this manual)

MAMD - Moving Average Maximum Density

ODOT - The Oregon Department of Transportation

PCC - Portland Cement Concrete

PM - Project Manager (Agency/Owner's Contract Administrator)

QA - Quality Assurance - generally refers to the Quality Assurance Program (See Section 2).

QAC - Quality Assurance Coordinator. See Section 2 (Quality Assurance Program).

QAE - Quality Assurance Engineer

QAT - Quality Assurance Technician. See Section 2 (Quality Assurance Program).

QC - Quality Control

QCCS - Quality Control Compliance Specialist (Agency or Contract Administrator performing the role of the QCCS). See Section 2 (Quality Assurance Program).

QPL - Qualified Products List

RAM – Recycled Asphalt Material

Random Sample – A sample of construction material taken at a random time or location. The sampling shall be performed according to a random number scheme. See Section 2 (Quality Assurance Program) for further discussion.

Random Number – A randomly selected number used to calculate a sampling time or location. See Section 2 (Quality Assurance Program) for discussion on selection and usage.

RAP - Reclaimed Asphalt Concrete Pavement

RAS – Recycled Asphalt Shingles

Specifications- Special Provisions, Plans & Drawings, Supplemental Specifications and Standard Specifications.

WAQTC - Western Alliance for Quality Transportation Construction

INSERT TAB

SECTION 1
Test Procedures

INDEX OF FIELD TEST PROCEDURES

PROCEDURE DATE	TITLE OF PROCEDURE	ODOT TM*	AASHTO T / R*	WAQTC TM*
2009	Embankment and Base Using Deflection Requirements	158		
2017	Establishing Maximum Dry Density and Optimum Moisture Content of Aggregate Base Materials	223		
2018	Presence of Wood Waste in Produced Aggregates	225		
2016	Evaluating Cleanness of Cover Coat Material	227		
2018	Determination of Elongated Material in Coarse Aggregates	229		
2015	Establishing Roller Patterns For Thin Lifts of ACP	301		
2016	Nuclear Density/Moisture Gauge Calibration and Effect of Hot Substrate	304		
2017	Calculating the Moving Average Maximum Density (MAMD)	305		
2015	Performing A Control Strip for ACP Pavement	306		
2019	Asphalt Content of Bituminous Mixtures by Plant Recordation	321		
2015	Asphalt Plant Calibration Procedure	322		
2018	Determination of Calibration Factors for Determining Asphalt Cement Content of ACP by Ignition Method	323		
2015	Preparation of Field Compacted Gyratory Specimens; Determination of Average G_{mb} for ACP Volumetric Calculations	326		
2018	Correlation of Nuclear Gauge Reading with Pavement Cores	327		
2018	Presence of Harmful Materials in Recycled Asphalt Shingles	335		
2015	Determining Random Sampling and Testing Locations	400		
2018	Static Modulus of Elasticity of Polymer Concrete Cylinders	759		
2019	Certification of Inertial Profiler-Operators and Equipment	769		
2008	Determining the Graphic Profile Index with a Profilograph	770		
2019	Determining the International Roughness Index with An Inertial Laser Profiler	772		
2007	Non-destructive Depth Measurement of Concrete Pavement	775		
2014	Evaluation of Retroreflectivity of Durable & High Performance Pavement Markings Using Portable Hand-Operated Instrument	777		
2018	Unit Weight and Voids in Aggregate		19	
2020	Compressive Strength of Cylindrical Concrete Specimens		22	
2018	Making and Curing Concrete Test Specimens in Field		23	
2020	Sieve Analysis of Fine and Coarse Aggregate, including Wet Sieve		27/11	
2019	Mechanical Analysis of Extracted Aggregate		30	
2017	Specific Gravity and Absorption of Fine Aggregate		84	
2020	Specific Gravity and Absorption of Coarse Aggregate		85	
2020	Moisture-Density Relations of Soils Using a 2.5kg Rammer and a 305-mm Drop and Moisture-Density Relations of Soils Using a 4.54kg Rammer and a 457-mm Drop		99/180	
2019	Slump of Hydraulic Cement Concrete		119	
2020	Mass Per Cubic Meter, Yield, and Air Content of Concrete		121	
2020	Air Content of Freshly Mixed Concrete by the Pressure Method		152	
2020	Bulk Specific Gravity of Compacted Bituminous Mixtures		166	

INDEX OF FIELD TEST PROCEDURES (CONTINUED)

PROCEDURE DATE	TITLE OF PROCEDURE	ODOT TM*	AASHTO T / R*	WAQTC TM*
2019	Plastic Fines In Graded Aggregates and Soils by the Use of the Sand Equivalent Test		176	
2020	Theoretical Maximum Specific Gravity and Density of Bituminous Paving Mixtures		209	
2018	Determination of Moisture in Soils and Fine Aggregate by Means of Calcium Carbide Gas Pressure Moisture Tester		217	
2017	Capping Cylindrical Concrete Specimens		231	
2016	Total Moisture Content of Construction Materials by Drying/Laboratory Determination of Moisture Content of Soils		255/265	
2018	One-Point Method for Determining Maximum Dry Density and Optimum Moisture		272	
2007	Resistance of Compacted Bituminous Mixture to Moisture Induced Damage		283	
2020	Determining the Asphalt Cement Content of HMA by the Ignition Method		308	
2020	Temperature of Freshly Mixed Portland Cement Concrete		309	
2020	In-Place Density of Embankment and Base using the Nuclear Moisture-Density Gauge		310	
2019	Hamburg Wheel-Track Testing of Compacted Asphalt Mixtures		324	
2020	Moisture Content of Hot Mix Asphalt (HMA) by Oven Method		329	
2017	Determining the Percentage of Fracture in Coarse Aggregate		335	
2020	In-Place Density of Asphalt Mixes by the Nuclear Method		355	
2019	Reducing Samples of Hot Mix Asphalt to Testing Size		R-47	
2016	Sampling Bituminous Materials		R 66	
2020	Sampling Bituminous Material After Compaction (Obtaining Cores)		R 67	
2016	Developing a Family of Curves		R 75	
2020	Reducing Samples of Aggregates to Testing Size		R 76	
2020	Sampling of Aggregates		R 90	
2020	Sampling of Asphalt Mixtures		R 97	
2020	Sampling Freshly Mixed Concrete			2
2019	Volumetric Properties of Hot Mix Asphalt (HMA)			13

* (T) – Test Method is a definitive procedure (such as identification, measurement or evaluation of properties) that produces a test result.

(R) – Recommended Practices are a definitive set of instructions for performing specific operations (such as sampling, collection, or inspection) that do not produce a test result.

(TM) – Test Method.

INSERT TAB

ODOT

ODOT TM 158

Method of Test for

IN-PLACE DENSITY OF EMBANKMENT AND BASE USING DEFLECTION REQUIREMENTS

Scope

This procedure covers the visual determination of density and relative compaction of soil, soil-aggregate mixes and base aggregates.

Definitions:

- **Deflection or Reaction** – A movement or deviation of material which returns back to a former or less advanced condition in a localized area directly under the test vehicle tire.
- **Pumping** – Vertical displacement of the top surface of the compacted layer, not directly under the vehicles tires.
- **Loaded Haul Vehicle** – Water truck or Construction material haul unit i.e. belly dump, end dump or similar.
- **GVW** – Gross Vehicle Weight.

Procedure - General

The compacted layer will be observed for deflection by using a loaded haul vehicle, loaded to the vehicles (GVW). The vehicle will be driven at a speed of 1 – 2 m/s (2 – 4 miles/hour) over the entire compacted layer. There shall be no deflection, reaction, or pumping of the ground surface (as defined above) observed under the moving vehicle's tires. It may be required that testing be performed under the observation of the Engineer.

Report

Results shall be reported on standard form (1793S & 1793B) or other form approved by the agency. Include the following information:

- Location of test & Represented Area, elevation of surface, and thickness of layer tested
- Visual description of material tested
- Description of the equipment used to perform the test
- Name and signature of the technician conducting the test

ODOT TM 223

Method of Test for

Establishing Maximum Dry Density and Optimum Moisture Content of Aggregate Base Materials

Scope

This procedure covers the adjustment of the maximum dry density determined by FOP for AASHTO T 99 Method A, to compensate for coarse particles retained on the (No. 4) sieve for aggregate base materials only. For Method A of FOP for AASHTO T 99 the adjustment is based on the percent, by mass, of material retained on the (No. 4) sieve and the bulk specific gravity G_{sb} of the material retained on the (No. 4) sieve; defined as oversized material.

This procedure will be used in conjunction with FOP for AASHTO T 99 Method A, FOP for AASHTO T-255 / 265 and FOP for AASHTO T 85.

This Process shall be used for Dense Graded Base Aggregate Separated Stockpile sizes of 1" - 0 and smaller. Dense graded Base Aggregate with Separated Stockpile sizes larger than 1" - 0 and Open Graded Base Aggregates are considered non-density testable and should be evaluated according to the appropriate specifications contained in the project contract documents.

Adjustment Equations

1. Use the Maximum Density (D_f) and corresponding Optimum Moisture (MC_f) content values determined by the FOP for AASHTO T 99 Method A, to represent the passing (No. 4) material.

For the oversized material use the values determined from FOP for AASHTO T 85. The Bulk Specific Gravity (G_{sb}) (k) and the Absorption (MC_c) information are needed.

2. The percentage of oversize material is based on the average percent passing value of the (No.4) determined by the statistical analysis program (StatSpec) during the crushing operation. See note 1. The percentage of oversize is calculated as follows:

$$P_c = (100 - P_f)$$

Where:

- P_f = Average (Mean) percent passing the (No. 4)
from StatSpec, rounded to closest whole value.
 P_c = Percent Retained (No. 4) material

Note 1: Utilizing the average percentage value of the (No. 4) during aggregate production is more representative of the material in the stockpile and eliminates bias that can be introduced during sampling and splitting procedures.

Adjustment Equation Moisture

3. Calculate the corrected moisture content as follows:

$$MC_T = \frac{[(MC_f)(P_f) + (MC_c)(P_c)]}{100} \qquad 7.2\% = \frac{[(10.6)(60) + (2.1)(40)]}{100}$$

MC_T = corrected moisture content of combined fines and oversized particles, expressed as a % moisture.

MC_f = moisture content of fine particles, as a % moisture (See Note 2).

MC_c = moisture content of oversized particles, as a % moisture (See Note 2).

P_f = percentage of fines

P_c = percentage of oversized material (coarse)

Note 2: Moisture content of oversize material is based on the Absorption value from FOP for AASHTO T 85. The moisture content of the fines is based on the FOP for AASHTO T 99.

Adjustment Equation Density

4. Calculate the corrected dry density of the total sample (combined fine and oversized particles) as follows (See Note 3):

$$D_d = \frac{100D_fk(0.9)}{[(D_f)(P_c) + (k \times 0.9)(P_f)]} \qquad \text{or} \qquad D_d = \frac{100}{\frac{P_f}{D_f} + \frac{P_c}{(k \times 0.9)}}$$

Where:

D_d = corrected total dry density (combined fine and oversized particles) kg/m^3 (lb/ft^3).

D_f = dry density of the fine particles kg/m^3 (lb/ft^3), determined by T 99 Method A.

P_c = percent of oversize particles, of 4.75 mm (No. 4)

P_f = percent of fine particles, of 4.75 mm (No. 4)

k = English: $62.4 \times$ Bulk Specific Gravity (G_{sb}) of coarse particles (lb/ft^3).

Note 3: Tests have shown that granular material can be compacted to 90% of the absolute dry density.

Calculation

Sample Calculations:

Maximum laboratory dry density (D_f):	140.4 lb/ft ³
Percent coarse particles (P_c):	40%
Percent fine particles (P_f):	60%
Bulk specific gravity (G_{sb}) of coarse particles (k):	(2.697) (62.4) = 168.3 lb/ft ³

$$D_d = \frac{100}{\frac{P_f}{D_f} + \frac{P_c}{(k \times 0.9)}}$$

$$D_d = \frac{100}{\frac{60}{140.4} + \frac{40}{(168.3 \times 0.9)}}$$

$$D_d = \frac{100}{\frac{60}{140.4} + \frac{40}{(151.5)}}$$

$$D_d = \frac{100}{0.42735 + 0.26403}$$

$$D_d = \frac{100}{0.69138}$$

$$D_d = 144.64 - \text{report as } - 144.6 \text{ lb/ft}^3$$

Report

Results shall be reported on ODOT Form 734-3468 B. Report combined maximum dry density to the nearest (0.1 lb/ft³) and combined optimum moisture content to the closest 0.1%.

ODOT TM225

Method of Test for

PRESENCE OF WOOD WASTE IN PRODUCED AGGREGATES

1. SCOPE

- A. This method of test covers a procedure for determining the presence of wood waste or other deleterious materials, here in known as Contaminate, in produced aggregates.

2. APPARATUS

- A. Sample splitter or a canvas suitable for splitting a sample.
- B. Balance or scale – Capacity sufficient for the masses listed in Table 1 of AASHTO T 27/ T 11 and accurate to 0.1 percent of the sample mass or to 0.1 g, meeting the requirements of AASHTO M 231.
- C. Drying Equipment - Per FOP for AASHTO T255 / T 265.
- D. Container and utensils - The container shall be of a size to permit covering the sample with (3" to 4") of water and a spoon.
- E. Sieve - (No. 40) meeting the requirements of AASHTO M 92.
- F. Optional mechanical aggregate washer.

3. SAMPLE

- A. The sample shall be obtained as per FOP for AASHTO R 90.
- B. The sample shall be split per FOP for AASHTO R 76.
- C. Size of sample shall conform to Table 1 of the FOP for AASHTO T 27/T 11.

4. PREPARATION OF SAMPLE

- A. Dry the sample to a constant mass per FOP for AASHTO T255 / 265. If the sample appears to contain Contaminate materials, use caution during the drying the process. A controlled oven maintained at a temperature of (230 ±9°F) should be utilized.

5. PROCEDURE

- A. Record the sample dry mass to the nearest 0.1 g.
- B. Place the dried sample into the container and cover with water to a height of 3" to 4".
- C. Agitate the sample with the spoon.
- D. Spoon or decant off any floating material over the (No. 40) sieve.

Steps B thru D can be completed during the performance of Method A of the FOP for AASHTO T 27 / T 11 by nesting the #40 sieve over the #200 sieve.

- E. Put the contaminate material into a container (suitable for the drying method being used) and dry this material in accordance with FOP for AASHTO T255 / T 265.
- F. Determine the Contaminate mass to the nearest 0.1 g, after determining the dry mass of the Contaminate, retain the Contaminate material.

6. CALCULATIONS AND REPORTS

- A. Wood Waste (nearest 0.01%) = $\frac{\text{Contaminant mass}}{\text{Sample mass}} \times 100$

- B. Report on **form 734-1792**.

ODOT TM 227

Method of Test for

EVALUATING CLEANNESS OF COVER COAT MATERIAL

SCOPE

The cleanness test indicates the relative amount, fineness, and character of clay-like materials present on aggregate as coatings or otherwise.

APPARATUS

- Funnel to hold nested No. 8 or No. 10 and No. 200 sieves at the large end and necked down to rest in a 500 ml graduate at the small end.
- Plastic wide-mouth one gallon jars with lids and rubber gaskets.
- Sand equivalent cylinder, rubber stopper, and timing device. These items are standard sand equivalent equipment.
- Graduated glass or plastic cylinders of 10 ml and 500 ml capacities.
- Sieves. No. 200 and a No. 8 or No. 10, full height.
- A balance or scale sensitive to 0.1 g.
- Sand equivalent stock solution.
- Splitter. Any device may be used which will divide the sample into representative portions. However, the riffle-type splitter is preferable to hand-quartering.
- Syringe or spray attachment.
- Forced draft, ventilated, or convection oven capable of maintaining a temperature of $230 \pm 9^{\circ}\text{F}$.

CONTROL

- Temperature of the wash solution shall be maintained within the range of 64°-82° F during performance of this test.
- Use distilled or demineralized water for performance of the cleanness test. This is necessary because the test results are affected by certain minerals dissolved in water.

PREPARATION OF SAMPLE

1. Split a representative portion of the sample large enough to yield 1000 g ± 50 g of material (FOP for AASHTO R 76).
2. The cover coat material must be tested in oven dry condition (FOP for AASHTO T 255). Drying temperature shall not exceed 230°F. Cool cover coat material to room temperature for testing.

PROCEDURE

1. Place the sand equivalent cylinder on a work table which will not be subjected to vibrations during the sedimentation phase of the test.
2. Pour 7 ml of the STOCK SOLUTION into the sand equivalent cylinder.
3. Nest the two sieves in the large funnel which in turn rests in the 500 ml graduate. The No. 8 or No. 10) sieve serves only to protect the No. 200 sieve.
4. Place the prepared sample in the one gallon jar. Add only enough water to completely cover the aggregate, and cap tightly.

Note: Do not add too much water at the beginning of the test, as only 500 ml is allowed after the final rinsing.

5. Begin agitation after one minute has elapsed from the introduction of the water. The agitation procedure is described as follows:
 - 5.1 While holding the jar vertically with both hands, the washing shall be done with an arm motion that causes the jar to rotate in a circle with approximately a 6" radius. The jar may be held either by the sides or by the top and bottom, whichever is more convenient.

Note: The jar itself does not turn on its vertical axis. The jar's vertical axis describes a circle with a 6" radius, as near as possible.

- 5.2 Continue this agitation at the rate of two complete rotations per second for one minute.
6. At the end of the agitation period, empty the contents of the jar over the nested No. 8 or No. 10) and No. 200 sieves.
7. Use the syringe or spray attachment and carefully wash out the jar, pouring the wash water over the nested sieves. Continue to wash the aggregate in the sieves until the graduate is filled to the 500 ml mark.
8. Remove the funnel and nested sieves from the graduate. Bring all solids in the wash water into suspension by capping the graduate with the palm of the hand and turning the cylinder upside down and right side up 10 times through 180°, as rapidly as possible.
9. Immediately pour the thoroughly mixed liquid into the sand equivalent cylinder until the 15" mark is reached.
10. Place the stopper in the end of the cylinder, and prepare to mix the contents immediately.
11. Mix the contents of the cylinder by alternately turning the cylinder upside down and right side up, allowing the bubble to completely traverse the length of the cylinder. Repeat this cycle 10 times in approximately 35 seconds. A complete cycle is from right side up to upside down and back to right side up.
 - 11.1 At the completion of the mixing process, place the cylinder on the work table and remove the stopper. Allow the cylinder to stand undisturbed for 20 minutes. Then immediately read and record to the nearest 0.1 inch, the height of the column of sediment.
12. Two unusual conditions may be encountered during this phase of the test.
 - 12.1 A clearly defined line of demarcation may not form in the specified 20 minutes. If this happens, allow the cylinder to stand until one forms, then immediately read and record.
 - 12.2 The liquid immediately above the line of demarcation may still be cloudy at the end of the 20 minutes. The line, although distinct, may appear to be in the sediment column itself. Read and use the line of demarcation after the end of the 20 minute period.

CALCULATIONS

Compute the cleanness value to the nearest whole number by the following formula:

ENGLISH

$$CV = \frac{3.214 - (0.214H)}{3.214 + (0.786H)} \times 100$$

Where: CV = Cleanness Value

H = Height of sediment in inches

Solutions to the above equation are given in Table 1.

TABLE 1**Cleanness Values (CV) for 0 to 15.0 inch Height Reading (H)**

Height Reading	CV	Height Reading	CV	Height Reading	CV	Height Reading	CV
0.0	100	4.0	37	8.0	16	12.0	5
0.1	97	4.1	36	8.1	15	12.1	5
0.2	94	4.2	36	8.2	15	12.2	5
0.3	91	4.3	35	8.3	15	12.3	5
0.4	89	4.4	34	8.4	14	12.4	4
0.5	86	4.5	33	8.5	14	12.5	4
0.6	84	4.6	33	8.6	14	12.6	4
0.7	81	4.7	32	8.7	13	12.7	4
0.8	79	4.8	31	8.8	13	12.8	4
0.9	77	4.9	31	8.9	13	12.9	3
1.0	75	5.0	30	9.0	13	13.0	3
1.1	73	5.1	29	9.1	12	13.1	3
1.2	71	5.2	29	9.2	12	13.2	3
1.3	69	5.3	28	9.3	12	13.3	3
1.4	68	5.4	28	9.4	11	13.4	3
1.5	66	5.5	27	9.5	11	13.5	2
1.6	64	5.6	26	9.6	11	13.6	2
1.7	63	5.7	26	9.7	11	13.7	2
1.8	61	5.8	25	9.8	10	13.8	2
1.9	60	5.9	25	9.9	10	13.9	2
2.0	58	6.0	24	10.0	10	14.0	2
2.1	57	6.1	24	10.1	9	14.1	1
2.2	55	6.2	23	10.2	9	14.2	1
2.3	54	6.3	23	10.3	9	14.3	1
2.4	53	6.4	22	10.4	9	14.4	1
2.5	52	6.5	22	10.5	8	14.5	1
2.6	51	6.6	21	10.6	8	14.6	1
2.7	49	6.7	21	10.7	8	14.7	0
2.8	48	6.8	21	10.8	8	14.8	0
2.9	47	6.9	20	10.9	7	14.9	0
3.0	46	7.0	20	11.0	7	15.0	0
3.1	45	7.1	19	11.1	7		
3.2	44	7.2	19	11.2	7		
3.3	43	7.3	18	11.3	7		
3.4	42	7.4	18	11.4	6		
3.5	41	7.5	18	11.5	6		
3.6	40	7.6	17	11.6	6		
3.7	40	7.7	17	11.7	6		
3.8	39	7.8	17	11.8	6		
3.9	38	7.9	16	11.9	5		

ODOT TM 229

Method of Test for

DETERMINATION OF FLAT and ELONGATED MATERIAL IN COARSE AGGREGATES

Scope

This procedure covers the determination of the percentage, by mass, of flat and elongated particles in coarse aggregates for comparison with specification limits.

Flat and elongated particles of aggregates, for some construction applications, may interfere with consolidation and result in harsh, difficult to place materials and a potentially unstable mixture.

For purposes of this test procedure, the term "Elongated Pieces" in applicable specifications shall be taken to be equivalent to the term "Flat and Elongated Particles" used in this test method.

Apparatus

- Balance or scale: Capacity sufficient for the principle sample mass, accurate to 0.1 percent of the sample mass or readable to 0.1 g.
- Sieves, meeting requirements of AASHTO M 92.
- Proportional Caliper Device, meeting the requirements of ASTM D 4791 and approved by the Agency.

Terminology

- Flat and Elongated Particles - Those aggregate particles having a ratio of length to thickness greater than a specified value.

Sampling and Sample Preparation

1. Sample the aggregate in accordance with AASHTO R 90.
2. Dry the sample sufficiently to obtain separation of coarse and fine material and sieve in accordance with AASHTO T 27 over the (No. 4) sieve. Discard the material passing the specified sieve.
3. Reduce the retained sample according to AASHTO R 76. The minimum sample mass shall meet the requirements listed in Table 1.

ODOT TM229(18)

**Table 1
Required Sample Size**

Nominal Maximum Size* (in)	Minimum Sample Mass Retained on (No. 4) Sieve g (lb)
1-1/2	2500 (6)
1	1500 (3.5)
3/4	1000 (2.5)
1/2	700 (1.5)
3/8	400 (0.9)
No. 4	200 (0.4)

Note: One sieve larger than the first sieve to cumulatively retain more than 10 percent of the material, using all the sieves listed in Table 1 in AASHTO R 90.

4. Determine the dry mass of the reduced portion of the sample to the nearest 0.1 g. This mass is designated **MS** in the calculation.

NOTE: If test is performed in conjunction with AASHTO T 335, recombine material from the fracture test and reduce to the appropriate sample size given in Table 1. The test may also be performed in conjunction with AASHTO T 335 on individual sieves and combined to determine an overall result if material on each individual sieve IS NOT further reduced from the original mass retained on each sieve.

Procedure

1. Set the proportional caliper device to the ratio required in the contract specifications: (2:1, 3:1, or 5:1)
2. Expedite testing through preliminary visual separation of all material which obviously is not flat and elongated.
3. Test each questionable particle by setting the larger opening of the proportional caliper device equal to the maximum dimension of the particle's length. Determine the dimension which represents the particle thickness (the smallest dimension). Pull the particle horizontally through the smaller opening without rotating, maintaining contact of the particle with the fixed post at all times. If the entire particle thickness can be pulled through the smaller opening, the particle is flat and elongated.
4. Determine the dry mass of the flat and elongated particles to the nearest 0.1 g. This mass is designated as **FE** in the calculation.

Calculation

Calculate the percent of flat and elongated pieces for the sample according to the following equation.

$$\% \text{ FE} = \frac{\text{FE}}{\text{MS}} \times 100$$

Where MS = Mass of retained sample
FE = Mass of flat and elongated pieces
%FE = Percent of flat and elongated pieces

Report

Report the percent flat and elongated pieces to the nearest 0.1% on a standard form approved for use by the Agency.

ODOT TM 301

Method of Test For

ESTABLISHING ROLLER PATTERNS FOR THIN LIFTS OF ACP

SCOPE

This method is a procedure which provides a method to establish the roller patterns and number of passes required to achieve a maximum density for the JMF, paving conditions, and equipment on the project. This method is used with the same rollers and materials to be used throughout the project. Changes in materials, rolling equipment or weather conditions may require establishment of new roller patterns. This procedure is used when required by the specifications to determine the optimum rolling pattern for ACP placed in lifts with a nominal thickness less than 2 in.

DEFINITIONS

- **In-Place Density** - the density of a bituminous mixture as it exists in the pavement. The in-place density will be determined using a Nuclear Moisture-Density Gauge according to AASHTO T 355 unless otherwise specified.
- **Evaluation Point** - a testing point selected within the roller pattern and used to determine the increasing in-place densities of the pavement with successive roller passes.
- **Roller Pass** - the passing of a roller over an area (roller width) one time.
- **Roller Coverage** - the rolling of the entire width of pavement one time, including roller overlaps.
- **Breakdown Rolling** - constitutes the first roller coverage on the mixture after it is placed.
- **Intermediate Rolling** - constitutes all rolling following the breakdown rolling, prior to the temperature of the mixture lowering to (180 °F).
- **Optimum Rolling Pattern** – the combination of rollers, temperatures, and roller passes which results in the maximum achievable density for the JMF, paving conditions, and equipment on the project.

- **Finish Rolling** - constitutes the roller coverage, after the intermediate rolling, required to bring the mixture to a smooth, tight surface, while the mixture is warm enough to permit the removal of any roller marks.

APPARATUS

- A nuclear density gauge meeting the apparatus requirements of AASHTO T 355.
- Transport case for properly shipping and housing the gauge and tools.
- Instruction manuals for the specific make and model of the gauge.
- A suitable thermometer for measuring the temperature of the paved surface.

DETERMINING OPTIMUM ROLLING PATTERN

1. An optimum rolling pattern shall be established when required by the specifications.
2. Two evaluation points shall be selected within the section being paved. The evaluation points must be at least 50 feet from a transverse joint; no closer than 2 ft. from the edge of the panel being placed, and in an area that is representative of the overall material and conditions of placement. The two evaluation points shall be located at the same station, but must be at least 3 ft. apart transversely. Make sure the evaluation points are not located where the roller passes overlap.
3. After each roller pass over the evaluation points, the nuclear gauge is used in the backscatter position to determine the in-place density with a 15-second count. Each un-sanded evaluation point is carefully marked so the subsequent tests are made in exactly the same positions and locations.
4. For each roller used and each pass over each evaluation point, record the type of roller, surface temperature, density in-place (15 second reading), direction of travel, and whether in vibratory or static mode. Average the readings from the two evaluation points after each pass.
5. Continue compacting and testing each evaluation point after each roller pass until the average of the readings from the two evaluation points does not increase. (The average of the two readings may decrease or level off to indicate this.)
6. The optimum rolling pattern consists of one less than the number of passes necessary to reach the point at which density does not increase as established in Step 5.

7. Any finish rolling necessary to remove roller marks will be in addition to the required number of passes for the optimum rolling pattern.

REPORT

The report shall be made on the Control Strip Method of Compaction for Thin Lifts of ACP Form 734-2084T.

ODOT TM 304
Method of Test for

**NUCLEAR DENSITY/MOISTURE GAUGE CALIBRATION
AND AFFECT OF HOT SUBSTRATE**

1. SCOPE

Determination of the accuracy and/ or to calibrate a Nuclear Density/Moisture Gauge and determine the effect of high temperatures, such as that found in Asphalt Concrete Pavements, on the proper functioning of the Nuclear Gauge.

Significance and Use

A Nuclear Density/Moisture Gauge calibration check and Hot Substrate Test shall be performed every 12 months or any time the calibration of the gauge is in question.

If a Nuclear Density/Moisture Gauge's accuracy is questioned in the field, a check may be performed per Appendix C of the MFTP. During this check process, Sections 3.A and 3.C maybe modified as deemed necessary by the Region QAC. This is to insure timely results of the Gauge's accuracy. If this check uses modifications and the gauge does not meet the requirements in Section 5, the gauge will require a calibration check per the test procedure without modification.

2. APPARATUS

- A.** A Nuclear Gauge capable of making moisture and density determinations. The Gauge shall be so constructed to be licensable in accordance with applicable health and safety standards, established by the Department of Human Services. A copy of the owner's Radioactive Materials License, Current Validation Certificate and a copy of the most current leak test results will accompany the Nuclear Gauge. The Nuclear Gauge shall be in good operating condition or it shall be returned for repairs.
- B.** A carrying /transport case.
- C.** Instruction manual, supplied by the gauge manufacturer, describing the operating procedures for the model of gauge being used.

- D. A reference standard block for obtaining standard counts and checking gauge operation.
- E. Logbook for recording daily counts obtained on the reference block.
- F. Calibration tables, as required, for determining the moisture content and the density from calculated count ratios.
- G. Calibration blocks of approximate densities 1717kg/m^3 (107.2 PCF), 2140kg/m^3 (133.6 PCF), and 2631kg/m^3 (164.3 PCF) large enough to represent an infinite below surface volume to the gauge.
- H. A High Moisture Calibration Block. Made of suitable material, which will produce a moisture reading of 839kg/m^3 (52.4PCF)?
- I. Surface temperature measuring device, capable of a range from -10°C to 150°C (0° to 300°F) readable to 2°C (5°F).
- J. Hot plate device consisting of an aluminum block, of adequate size, that fits on an electric hot plate mounted on a dolly. The electric hot plate requires a 120 volt, 60 hertz power source.
Note: ODOT uses an aluminum block 41cm (16in) x 46cm (18in) x 16cm (6.3in).

3. Nuclear Density Gauge Preparation

- A. The Gauge may need to be placed in a temperature controlled area for no less than 4 hours, to assure component parts are at a room temperature of 16°C (60°F) to 24°C (75°F).
- B. Turn the gauge on and allow it to warm up for a minimum of 10 minutes.
- C. Place the Standard count block in the center of the middle calibration block. With the standard count block in this position, perform five standard counts in accordance with the manufacturer's guidelines. Record the standard counts on the Nuclear Density Gauge Calibration Check Sheet and, check that the variances between counts are within the manufacturer's guidelines. If the variances between counts are within the manufacturer's guidelines go to section 3. E.

D. If, the variances between counts are **not** within the manufacturer's guidelines.

1. Continue performing standard counts in accordance with the manufacturer's guidelines. Record and check each standard count for compliance with manufacturer's guidelines. No more than two additional standard counts should be performed.
2. If the manufacturer's guidelines are met, go to section 3.E.
3. If the manufacturer's guidelines **not** are met within two additional standard counts or the additional standard counts continue to show variances outside the manufacturer's guidelines, contact the gauge owner, inform them of the problem and arrange for the return of the gauge.

E. Set the gauge to take one-minute counts.

4. Nuclear Density Gauge Hot Substrate Test

- A.** Plug in or turn on the heating device for the aluminum block. Heat the block to $85^{\circ}\text{C} \pm 2^{\circ}\text{C}$ or $185^{\circ}\text{F} \pm 4^{\circ}\text{F}$ and check the temperature by using a surface thermometer. (*Heating of the block usually takes 4 to 6 hours.*)
- B.** With the gauge at room temperature of 16°C (60°F) to 24°C (75°F) and the block at 85°C (185°F). Place the gauge on the block, immediately move the source into the backscatter position and start a one-minute count.
- C.** Record the first wet density in the "Initial Test" column of the Hot Substrate Test portion of the Nuclear Density Gauge Calibration Check Sheet and immediately start a second one-minute count. Continue taking one-minute counts and recording wet densities until there are a total of four.
- D.** Leave the gauge on the block for 10 minutes.
- E.** At the conclusion of the 10-minute waiting period, immediately start a one-minute count. Record the wet density in the "Final Test" column of the Hot Substrate Test portion of the Nuclear Calibration Check Sheet and immediately start a second one-minute count. Continue taking one-minute counts and recording wet densities until there is a total of four. Remove the gauge from the block to cool.

- F. If, at anytime during the test, the gauge display fogs or becomes unreadable due to moisture, the gauge fails this test. Input no data on the Nuclear Density Gauge Calibration Check Sheet and put an explanation of why the gauge failed in the “Remarks” section, then sign and date the sheet. Contact the gauge owner and arrange for it’s return. A copy of the Nuclear Density Gauge Calibration Check Sheet shall be made available to the gauge owner.
- G. Average the “Initial test” column and average the “Final test” column. Compare the Initial test average to the Final test average. If the averaged densities are within 16 kg/m³ (1.0 lbs/ft³) the gauge passes this test. If the averaged densities are not within 16 kg/m³ (1.0 lbs/ft³) the gauge fails.
- H. If the results “Pass”, indicate the result on the Nuclear Density Gauge Calibration Check Sheet under “Hot Substrate Results”. Allow the gauge to cool to room temperature and then proceed with the calibration check.
- I. If the results “Fail”, indicate the result on the Nuclear Density Gauge Calibration Check Sheet under “Hot Substrate Results”, then sign and date it. If an O.D.O.T. Quality Assurance Program Inspection Tag is currently on the gage, remove it from the gage and place it with Nuclear Density Gauge Calibration Check Sheet in your records. Inform the owner of the failure and arrange for the return of the gauge. A copy of the Nuclear Density Gauge Calibration Check Sheet shall be made available to the gauge owner.

5. NUCLEAR DENSITY/MOISTURE GAUGE ANNUAL CHECK OF ACCURCY FOR GAUGES WITH INTERNAL COMPUTERS

- A. The calibration blocks shall be located in accordance with the manufacturer's recommendations, and no other unshielded Nuclear gauge shall be within 15 meters (50 feet) during annual check of accuracy or calibration. An example of a the Nuclear Density Gauge Calibration Check sheet is enclosed with this procedure
- B. Block Values used by ODOT.

	Back Scatter	Direct Transmission
Low Density	1735 kg/m ³ (108.3 PCF)	1717 kg/m ³ (107.2PCF)
Medium Density	2161 kg/m ³ (134.9PCF)	2140 kg/m ³ (133.6PCF)
High Density	2657 kg/m ³ (165.9PCF)	2632 kg/m ³ (164.3PCF)

- C. With the gauge at room temperature 16⁰C (60⁰F) to 24⁰C (75⁰F). Locate the gauge on the Low-Density block so the edge of the gauge closes to the probe is 2.5cm (1inch) from the edge of the transmission hole and the gauge is in the center of the block. The gauge shall not be placed on the block in such a manner so that it covers the transmission hole during backscatter reading. Move the handle into the backscatter position. Perform two one-minute counts and record the wet density results.
- D. Repeat this process on the Medium and High Density blocks.
- E. Locate the source rod in the 50 mm(two inch) direct transmission position and seat in the transmission hole of the Low density block. Perform two one-minute counts and record the wet densities.
- F. Repeat the counting and recording procedures for all depth increments to the maximum depth on the Low, Medium, and High Density Blocks.
- G. Average each individual depth's results and compare the averaged result with the respective block densities listed above. If this is an annual check then the averaged results must be within +- 16kg/m³ (1.0 lbs/ft³) on the low and Medium Density blocks and +- 24kg/m³ (1.5 lbs/ft³) on the High Density Block of the values given in section 5B or the gauge fails and must be recalibrated, go to section 7. If this is a check of a gauge recalibrated in accordance with section 7 of this procedure then the results are all to be within the within +- 16kg/m³ (1.0 lbs/ft³) of the values given in section 5B. If the above parameters are met, continue to 5H. If the above parameters are **not** met the gauge must be recalibrated in accordance with section 7.
- H. Place the gauge on the Low Density Block so as not to be influenced by the transmission hole. Move the handle into the backscatter position. Perform one four-minute count and record the moisture density. The moisture density must be within +- 8 kg/m³ (0.5 lbs/ft³) of 0 kg/m³ (0.0 lbs/ft³), if it is not the gauge must be recalibrated according to section 7.
- I. Place the High Moisture Block on the High Density Block. Place the gauge on the High Moisture Block. Move the handle into the backscatter position. Perform one four-minute count and record the moisture density. The moisture density must be within +- 16 kg/m³ (1.0 lbs/ft³) of 839 kg/m³ (52.4 lbs/ft³), if it is not the gauge must be recalibrated according to section 7.

6. NUCLEAR DENSITY/MOISTURE GAUGE CALIBRATION AND CHECK FOR GAUGES THAT DO NOT HAVE INTERNAL CALIBRATION CAPABILITY.

The use of this type of gauge is rare, Contact ODOT for the appropriate procedure if required.

7. NUCLEAR DENSITY/MOISTURE GAUGE CALIBRATION PROCEDURE.

- A.** Gauges must have a new calibration performed if any of the parameters in section 5 are not met. An example of a recording sheet is enclosed with this procedure.
- B.** With the gauge at room temperature 16⁰C (60⁰F) to 24⁰C (75⁰F). Locate the gauge on the Low-Density block so as not to be influenced by the transmission hole. Move the handle into the backscatter position. Set the gauge to take four-minute counts and if applicable set to read in counts. Perform two four-minute counts and record the Density counts.
- C.** Repeat this process on the Medium and High Density blocks. Average the two counts for each individual block.
- D.** Locate the source rod in the 50 mm(two inch) direct transmission position on the Low density block and seat in the transmission hole. Perform one four-minute count and record the depth and Density count for that depth.
- E.** Repeat the counting and recording procedures for all depth increments to the gauge's maximum depth on all three blocks.
- F.** Input the data into NCAL or other calibration program in accordance with the programmer's guidelines.
 - 1. Note - must use the averaged backscatter counts that have been rounded to the nearest whole number when entering into NCAL.
 - 2. Note - when counts are too large to enter into NCAL, all counts, including standard counts must be divided by ten.
- G.** Print out the new constants.
- H.** Before the new constants are entered into the gauge, record the constants currently being used by the gauge.

- I. Input the new constants in the gauge in accordance with the manufacturer's recommendations.
- J. With the new constants in the gauge, the gauge must be checked for accuracy. Perform the accuracy check in accordance with section 5.
- K. For gauges calibrated by ODOT:
 - 1) Upon successful completion of the accuracy check, record in a log the manufacturer and model of the gauge, the serial number, and the owner of the gauge.
 - 2) Complete the Nuclear Density Gauge Calibration Check Sheet. Make a copy of the Check Sheet, which is to be kept with the gauge.
 - 3) Contact the owner and arrange for the return of the gauge.

8. Gauges calibrated by others:

- A. All gages must be verified by ODOT in accordance with section 5.
- B. Upon successful verification by ODOT, record in a log the manufacturer and model of the gauge, the serial number, and the owner of the gauge.
- C. A copy of the calibration and ODOT verification is to be kept with the gauge.
- D. Arrange for the return of the gauge.

9. Report

Each work sheet shall include:

- Manufacturer and model number of gauge
- Serial number of gauge
- Gauge owner
- Date of calibration check
- Name of technician performing calibration check
- Block densities to the nearest 1 Kg/m³ or 0.1 lbs/ft³
- Moisture Block densities to the nearest 0.1 Kg/m³ or 0.1 lbs/ft³
- Gauge, wet density readings to the nearest 1 Kg/m³ or 0.1 lbs/ft³
- Moisture reading check to the nearest 0.1 Kg/m³ or 0.1 lbs/ft³
- Signature of technician performing calibration check

10. File

A file should be generated (electronic or paper) for each gauge checked. This file should at a minimum contain the following information:

- Initial check documentation report
Worksheet from Section 9
- If calibration was performed:
Initial check documentation report
Generated Constants
Check documentation report Worksheet from Section 9

The work sheets included with this test method are available in an Excel format. Contact the closest Quality Assurance Coordinator to your location.



Nuclear Density Gauge Calibration Check ODOT TM304

MAKE: _____ MODEL: _____ DATE: _____
 SERIAL NO: _____ GAUGE OWNER: _____

Standard Block has been verified: to have the same SN as the gauge being checked and that it is not cracked, split, delaminated or otherwise damaged.

	1st	2nd	3rd	4th	Average	5th	% Diff
DENSITY STANDARD:							
MOISTURE STANDARD:							

HOT SUBSTRATE TEST @ 185° F ± 4° F

BS	INITIAL TEST		Wait Ten Minutes	FINAL TEST	
		Lb/cu.Ft			Lb/cu.Ft
Four one-minute counts	1			1	
	2			2	
	3			3	
	4			4	
	AVE			AVE	

RESULTS:

CALIBRATION CHECK

Probe Depth	BS	2	4	6	8	10	12
	108.3	107.2					
LOW BLOCK READINGS							
Average Readings							

	134.9	133.6					
MEDIUM BLOCK READINGS							
Average Readings							

	165.9	164.3					
HIGH BLOCK READINGS							
Average Readings							

LO BLOCK MOIST 0.0 Lb

FOUR-MINUTE COUNT	H2O (Lb)
-------------------	----------

RESULTS:

HI BLOCK MOIST 52.4 Lb

FOUR-MINUTE COUNT	H2O (Lb)
-------------------	----------

RESULTS:

New Calibration by ODOT? YES NO

NOTES:

SIGNATURE: _____ DATE: _____





Nuclear Density Gauge Calibration Check ODOT TM304

MAKE: Troxler MODEL: 3430 DATE: 10/14/2010
 SERIAL NO: 12345 GAUGE OWNER: Nuke Guage Testers inc

Standard Block has been verified: to have the same SN as the gauge being checked and that it is not cracked, split, delaminated or otherwise damaged.

	1st	2nd	3rd	4th	Average	5th	% Diff
DENSITY STANDARD:	3000.0	3050.0	3050.0	3000.0	3025.0	3055.0	1.0
MOISTURE STANDARD:	430.0	430.0	420.0	420.0	425.0	420.0	-1.2

HOT SUBSTRATE TEST @ 185° F ± 4° F

BS	INITIAL TEST	Lb/cu.Ft	Wait Ten Minutes	FINAL TEST	Lb/cu.Ft
	Four one-minute counts	1		165.5	1
	2	165.5		2	165.5
	3	165.5		3	165.5
	4	165.5		4	165.5
	AVE	165.5		AVE	165.5

RESULTS:
PASS

CALIBRATION CHECK

Probe Depth	BS	2	4	6	8	10	12
	108.3	107.2					
LOW BLOCK READINGS	108.3	107.2	107.2	107.2	107.2	107.2	107.2
	108.3	107.2	107.2	107.2	107.2	107.2	107.2
Average Readings	108.3	107.2	107.2	107.2	107.2	107.2	107.2
	PASS	PASS	PASS	PASS	PASS	PASS	PASS

	BS	2	4	6	8	10	12
	134.9	133.6					
MEDIUM BLOCK READINGS	134.9	133.6	133.6	133.6	133.6	133.6	133.6
	134.9	133.6	133.6	133.6	133.6	133.6	133.6
Average Readings	134.9	133.6	133.6	133.6	133.6	133.6	133.6
	PASS	PASS	PASS	PASS	PASS	PASS	PASS

	BS	2	4	6	8	10	12
	165.9	164.3					
HIGH BLOCK READINGS	165.9	164.3	164.3	164.3	164.3	164.3	164.3
	165.9	164.3	164.3	164.3	164.3	164.3	164.3
Average Readings	165.9	164.3	164.3	164.3	164.3	164.3	164.3
	PASS	PASS	PASS	PASS	PASS	PASS	PASS

LO BLOCK MOIST		0.0 Lb
FOUR-MINUTE COUNT	H2O (Lb)	
		0.0
RESULTS:		PASS

HI BLOCK MOIST		52.4 Lb
FOUR-MINUTE COUNT	H2O (Lb)	
		52.4
RESULTS:		PASS

New Calibration by ODOT? YES NO

NOTES:

SIGNATURE: _____ DATE: 10/14/2010



OREGON DEPARTMENT OF TRANSPORTATION
CALIBRATION DATA SHEET

MAKE: _____ CALIB. DATE: _____

MODEL: _____ TECHNICIAN: _____

SERIAL NUMBER: _____

OWNER OF GAUGE: _____

DENSITY STANDARD: _____

MOISTURE STANDARD: _____

		Count	Kg/m3	Count	Kg/m3	Count	Kg/m3
BLOCK WT.		1734		2161		2658	
BS 4 Min	1						
	2						
	A						

BLOCK WT.		1717		2140		2632
50	4Min					
100	4Min					
150	4Min					
200	4Min					
250	4Min					
300	4Min					

LO BLOCK MOISTURE

FOUR-MINUTE COUNT: _____

HI BLOCK MOISTURE

FOUR-MINUTE COUNT: _____

CAL. CHANGE RECALIBRATE GAUGE DATA

SIGNATURE \ DATE: _____

Recalibrate

MAKE: CALIB. DATE:

MODEL: TECHNICIAN:

SERIAL NUMBER:

OWNER OF GAUGE:

DENSITY STANDARD: 2829

MOISTURE STANDARD: 689

BLOCK WT.		Count	Kg/m3	Count	Kg/m3	Count	Kg/m3
			1734		2161		2658
BS 4 Min	1	8721		6547		4847	
	2	8670		6545		4817	
	A	8696		6546		4832	

BLOCK WT.		Count	Kg/m3	Count	Kg/m3	Count	Kg/m3
			1717		2140		2632
50	4Min	52609		35916		23503	
100	4Min	46386		29489		17719	
150	4Min	32499		19261		10657	
200	4Min	20580		11205		5933	
250	4Min						
300	4Min						

LO BLOCK MOISTURE

FOUR-MINUTE
COUNT: 744.0

HI BLOCK MOISTURE

FOUR-MINUTE
COUNT: 12601.0

CAL. CHANGE RECALIBRATE GAUGE DATA

SIGNATURE \ DATE: _____

Recalibrate



Nuclear Density Gauge Calibration Check ODOT TM304

MAKE:

MODEL:

DATE:

SERIAL NO:

GAUGE OWNER:

HOT SUBSTRATE TEST @ 185 F + or - 4 F

BS	INITIAL TEST		Wait Ten Minutes	FINAL TEST	
		Lb/cu.Ft			Lb/cu.Ft
Four one-minute counts	1			1	
	2			2	
	3			3	
	4			4	
	AVE			AVE	

RESULTS:

DENSITY STANDARD:					
MOISTURE STANDARD:					

CALIBRATION CHECK

Probe Depth	BS	2	4	6	8	10	12
	108.3	107.2					
LOW BLOCK READINGS							
Average Readings							

	134.9	133.6					
MEDIUM BLOCK READINGS							
Average Readings							

	165.9	164.3					
HIGH BLOCK READINGS							
Average Readings							

LO BLOCK MOIST 0.0 Lb

FOUR-MINUTE COUNT	H2O (Lb)

RESULTS:

HI BLOCK MOIST 52.4 Lb

FOUR-MINUTE COUNT	H2O (Lb)

RESULTS:

New Calibration by ODOT?

YES

NO

NOTES:



SIGNATURE: _____

DATE: _____



Nuclear Density Gauge Calibration Check ODOT TM304

MAKE:

MODEL:

DATE:

SERIAL NO:

GAUGE OWNER:

HOT SUBSTRATE TEST @ 185 F + or - 4 F

BS	INITIAL TEST	Lb/cu.Ft	Wait Ten Minutes	FINAL TEST	Lb/cu.Ft
	Four one-minute counts	1		165.4	1
	2	165.3		2	165.8
	3	166.7		3	165.9
	4	168.8		4	165.9
	AVE	166.6		AVE	166.1

RESULTS:

PASS

DENSITY STANDARD:	2826.0	2831.0	2820.0	2829.0	2829.0
MOISTURE STANDARD:	693	682.0	685.0	690.0	689.0

CALIBRATION CHECK

Probe Depth	BS	2	4	6	8	10	12
-------------	----	---	---	---	---	----	----

	108.3	107.2					
LOW BLOCK READINGS	108.9	107.6	107.8	107.4	107.0	107.1	107.0
	109.2	107.7	106.8	107.3	107.1	108.0	107.3
Average Readings	109.1	107.7	107.3	107.4	107.1	107.6	107.2
	PASS	PASS	PASS	PASS	PASS	PASS	PASS

	134.9	133.6					
MEDIUM BLOCK READINGS	134.5	132.8	132.8	133.3	134.1	133.5	133.7
	134.4	133.3	132.9	133.1	134.0	133.9	133.8
Average Readings	134.5	133.1	132.9	133.2	134.1	133.7	133.8
	PASS	PASS	PASS	PASS	PASS	PASS	PASS

	165.9	164.3					
HIGH BLOCK READINGS	165.1	165.1	164.7	164.4	165.0	164.4	165.8
	165.0	164.1	164.4	164.7	165.1	165.5	165.7
Average Readings	165.1	164.6	164.6	164.6	165.1	165.0	165.8
	PASS	PASS	PASS	PASS	PASS	PASS	FAIL

LO BLOCK MOIST	0.0 Lb
FOUR-MINUTE COUNT	H2O (Lb)
	0.3
RESULTS:	PASS

HI BLOCK MOIST	52.4 Lb
FOUR-MINUTE COUNT	H2O (Lb)
	51.4
RESULTS:	PASS

New Calibration by ODOT?

YES

NO

NOTES:



SIGNATURE: _____

DATE: _____

MAKE: CALIB. DATE:

MODEL: TECHNICIAN:

SERIAL NUMBER:

OWNER OF GAUGE:

DENSITY STANDARD:

MOISTURE STANDARD:

		Count	Lb/Ft3	Count	Lb/Ft3	Count	Lb/Ft3
BLOCK WT.			108.3		134.9		165.9
BS 4 Min	1						
	2						
	A						

		Count	Lb/Ft3	Count	Lb/Ft3	Count	Lb/Ft3
BLOCK WT.			107.2		133.6		164.3
2	4Min						
4	4Min						
6	4Min						
8	4Min						
10	4Min						
12	4Min						

LO BLOCK MOISTURE

FOUR-MINUTE
COUNT:

HI BLOCK MOISTURE

FOUR-MINUTE
COUNT:

CAL. CHANGE Calibration Data

SIGNATURE \ DATE: _____

Recalibrate

MAKE: CALIB. DATE:

MODEL: TECHNICIAN:

SERIAL NUMBER:

OWNER OF GAUGE:

DENSITY STANDARD: 2829

MOISTURE STANDARD: 689

BLOCK WT.		Count	Lb/Ft3	Count	Lb/Ft3	Count	Lb/Ft3
			108.3		134.9		165.9
BS 4 Min	1	8721		6547		4847	
	2	8670		6545		4817	
	A	8696		6546		4832	

BLOCK WT.		Count	Lb/Ft3	Count	Lb/Ft3	Count	Lb/Ft3
			107.2		133.6		164.3
2	4Min	52609		35916		23503	
4	4Min	46386		29489		17719	
6	4Min	32499		19261		10657	
8	4Min	20580		11205		5933	
10	4Min						
12	4Min						

LO BLOCK MOISTURE

FOUR-MINUTE
COUNT: 744.0

HI BLOCK MOISTURE

FOUR-MINUTE
COUNT: 12601.0

CAL. CHANGE Calibration Data

SIGNATURE \ DATE: _____

Recalibrate

ODOT TM 305

Method of Test For

CALCULATING THE MOVING AVERAGE MAXIMUM DENSITY (MAMD)

Scope

This method establishes the procedure for calculating the Moving Average Maximum Density (MAMD). The MAMD is the reference density used in conjunction with density readings from the random site location to determine the percent compaction for comparing with required specification limits.

Definitions

Gmm - Maximum theoretical or “rice” specific gravity determined according to AASHTO T 209. If the “dryback” procedure in AASHTO T 209 is required or specified for determining the rice values for a JMF, then the “dryback” rice shall be used for MAMD calculation.

Maximum Density Test (MDT) - Maximum density for the mixture calculated according to the following:

$$\text{MDT} = G_{mm} \times 62.4 \text{ lb/ft}^3$$

Procedure

1. Determine the MDT for the first subplot produced each day. A minimum of one MDT is required each day of production, even if no random subplot sample is obtained. For production days when the first random subplot sample will not occur until late in the shift, a separate sample for MDT may be obtained early in the shift. Note the purpose of the sample on project documentation. All provisions of this procedure and AASHTO T 209 still apply to a non-subplot sample MDT.
2. AASHTO T 209 is required for each subplot, however, for purposes of calculating the MAMD, use only the MDT from the first subplot produced each day.
3. If a MDT result varies more than 1.3 lb/ft³ from the previous MAMD, obtain another sample and determine a new *Gmm* and MDT. If the second MDT is closer to the previous MAMD than the first MDT, use it in the MAMD calculation. If not, use the first MDT.

4. Any MDT representing rejected materials will not be included in the MAMD calculation. Obtain a sample representing nonrejected material to determine the daily MDT.
5. Calculate the MAMD as follows:
 - 5.1 The initial MAMD is the MDT for the first production day.
 - 5.2 The next MAMD is the average of the MDT's from the first two production days.
 - 5.3 The next MAMD is the average of the MDT's from the first three production days.
 - 5.4 The next MAMD is the average of the MDT's from the first four production days.
 - 5.5 For the fifth day, the MAMD is the average of the MDT's for the first 5 production days.
 - 5.6 For future production days, the MAMD is the average of the MDT for that day and the MDT's from the previous 4 production days.
6. A new MAMD must be started when a new JMF is used. A JMF adjustment is not considered a new JMF.
7. A change in Lots due to a change in the minimum required compaction or due to a change in the test procedure used to determine asphalt content does not require a new MAMD calculation to be started.

Report

Report MAMD to the nearest 0.1 lb/ft³. Document MAMD calculations on Form 734-2050

Example

MDT Date	MDT	MAMD	MAMD - MDT
8/1/02	168.3	168.3	0.0
8/2/02	167.0	167.7	1.3
8/3/02	166.5	167.3	1.2
8/4/02	165.5*	167.1	1.8
	166.4**		0.9
8/5/02	166.2	166.9	0.9
8/8/02	166.0	166.4	0.4

* MDT is more than 1.3 lb/ft³ (167.3-165.5 = 1.8) from the last MAMD. Another MDT test is required.

** 166.4 is closer to the previous MAMD(167.3) than 165.5, therefore 166.4 is used to calculate the MAMD.

ODOT TM 306

Method of Test For PERFORMING A CONTROL STRIP FOR ACP PAVEMENT

SCOPE

A control strip is a field procedure, which provides data to establish roller patterns, which will achieve a maximum density. The method is designed to use the same compaction equipment and materials throughout the project. Changes in materials, compaction equipment, or weather conditions, may require a new roller pattern or verification of the adequacy of the roller pattern being used.

SIGNIFICANCE AND USE

This procedure is used to determine the optimum rolling pattern for ACP and evaluate the JMF for in-place properties that could impact overall performance of the placed material. This evaluation can determine whether the ACP in place void content is too low or high and is an indicator of potential problems with the JMF proportions.

GENERAL PROCEDURE

The procedure is performed in two separate phases using an initial site to collect the roller information and confirming the rolling pattern is consistent and uniform.

1. An initial point is used to establish the maximum density that can be achieved with a JMF and the compaction equipment used.
2. Using the roller information collected during the initial point evaluation, the optimum rolling pattern is applied to a test strip section and tested to ensure that the optimum roller pattern achieved specified density and uniformity.

DEFINITIONS

- **In-Place Density** - The density of the compacted bituminous mixture as it exists in the pavement. The in-place density will be determined, in accordance with AASHTO T 355, using a Nuclear Moisture-Density Gauge unless otherwise specified.
- **Control Strip Length** – This is equal to the length of the rolling pattern being used for compaction of a section of pavement that has been placed to the specified width and thickness. **Maximum length shall not exceed 500 ft.**
- **Initial Point** - A testing point selected and used to determine the increasing in-place densities of the pavement with successive roller passes.
- **Roller Pass** - The passing of a roller over an area (roller width) one time.
- **Roller Coverage** - The rolling of the entire width of pavement one time, including roller overlaps.

- **Breakdown Rolling** - The first roller coverage's on the mixture after it is placed.
- **Intermediate Rolling** - All rolling following the breakdown rolling, until the temperature of the mixture cools to a temperature at which it can be finish rolled.
- **Finish Rolling** - All rolling after the intermediate rolling that is required to bring the mixture to a smooth surface and remove any roller marks.

APPARATUS

- A nuclear density gauge meeting the apparatus requirements of AASHTO T 355.
- transport case for properly shipping and housing the gauge and tools
- instruction manuals for the specific make and model of the gauge
- filler material and tools to process the filler material
- a suitable thermometer for measuring the temperature of the paved surface

PERFORMING CONTROL STRIP

Initial Point Evaluation

1. A control strip shall be constructed when required by the specifications. The initial point shall be established within the first 200 ton of production unless otherwise approved by the Engineer. If a uniform rolling pattern cannot be established in a reasonable manner to complete a control strip the first day of placing ACP, contact the Engineer.
2. The control strip shall meet the following conditions:
 - A. Match the length of the rolling pattern with a maximum length of 500 ft.
 - B. Part of the roadway
 - C. Placed to the specified width and thickness of roadway design
 - D. Composed of the same materials as the rest of the lift
 - E. Compacted with the same equipment as the rest of the lift
3. An **Initial Point** is selected. The initial point must be at least 50 ft. from the beginning of the mat placement and no closer than 2 ft. from the edge of the mat and in an area that is representative of the overall material being placed.
4. After each roller pass over the initial point the nuclear gauge is used in the backscatter position to determine the in-place density, with a 15 second count. The un-sanded initial point is carefully marked so that subsequent tests are made in exactly the same position and location.
5. For each roller used and each pass over the initial point record the type of roller, surface temperature, density in-place (15 second reading), direction of travel, and whether vibratory or static mode. The information is recorded on the Control Strip Method of Compaction Testing, Form 734-2084.

6. Continue compaction and testing after each roller pass, until the density readings taken at the initial point do not increase. (The density readings may decrease or level off to indicate this.) Note: A time delay in roller passes might occur during this process, due to ACP showing signs of tenderness or movement. (Often associated with moisture and/or oil related properties).
7. The density of the initial point is then tested according to AASHTO T 355. The density readings are recorded.
 - If the density of the initial point meets the minimum specified density continue with step 1, Test Strip Evaluation. For Control Strips constructed at the beginning of production of a JMF, use the MDT from the JMF until the first MDT from produced mix is available. Use the first MDT from produced mix as the MAMD (per ODOT TM 305) after it is available. Control Strips constructed at all other times, use the current MAMD.
 - If the initial point does not meet minimum specified density, adjustments to the rolling pattern or compaction equipment must be made. After the adjustments have been made, a new control strip area is selected and tested starting with step 1.

Test Strip Evaluation

The optimum roller pattern determined in the Initial point evaluation process shall be applied to a test strip location.

1. A new test strip section shall be constructed and meet the following conditions:
 - A. Match the length of the rolling pattern with a maximum length of 500 ft.
 - B. Part of the roadway
 - C. Placed to the specified width and thickness of roadway design
 - D. Composed of the same materials as the rest of the lift
 - E. Compacted with the same equipment as the rest of the lift
2. After the optimum rolling pattern has been applied select five test locations at random stations within the test strip section (Random Stations per Form 734-1972 or other approved method). The transverse locations shall be at:
 1. 1 ft. from left edge of panel
 2. Midpoint of left half of panel
 3. Center of panel
 4. Midpoint of right half of panel
 5. 1 ft. from right edge of panel

Test the five random locations according to AASHTO T 355. The results of the density tests are recorded to the nearest 0.1 #/cf.

Control Strip Evaluation

3. The Control Strip is valid only if the following conditions are met:
 - A. The initial point meets the minimum specified compaction required.
 - B. The individual densities of the five random test locations from Test Strip Evaluation Step 2 are within $\pm 1.5\%$ of the average compaction of the five random tests.
 - C. The average density of the five Test Strip Evaluation random test locations is no less than the minimum specified compaction required.
4. Immediately inform the CAT II of the results of the control strip. If any of the density test locations are over 95% compaction (based on MAMD) inform the Project Manager or designated representative and the paving contractor's representative.
5. **Any points used to develop the control strip are not allowed to be used as subplot quality control/acceptance tests.**

REPORT

The report shall be made on the Control Strip Method of Compaction Testing, Form 734-2084.

ODOT TM 321

Method of Test for

Asphalt Content of Bituminous Mixtures by Plant Recordation

1. SCOPE

This method contains the procedures for determining the asphalt content, RAM or RAS content, lime content, mineral filler content, fiber content, and liquid additive content of ACP and EAC mixtures produced by batch, drum, or other acceptable mixing plants. Use of this method is contingent on consistent agreement between the plant recording equipment (meters and/or scales) and a physical inventory of the materials used. If the agreement between the inventory and plant recording equipment does not exist, the inventory data will be used to adjust the recordation data for acceptance.

2. SIGNIFICANCE AND USE

This method can be used to determine the asphalt content of a mixture at any point in time for determining the acceptance of a product and to determine partial payment for the product. It can be applied to batch, drum, or other acceptable plants and for all asphalt mixture constituents, including percent of RAM or RAS, percent of Lime, percent of mineral filler, percent of fiber, percent of liquid additive, and any other additives.

3. TERMINOLOGY

- 3.1 **Reclaimed Asphalt Pavement (RAP)** – removed and/or processed pavement materials containing asphalt binder and aggregate.
- 3.2 **Recycled Asphalt Shingles (RAS)** – tear-off or manufacturer waste shingle product materials containing asphalt and fine aggregate and fiberglass material.
- 3.3 **Recycled Asphalt Material (RAM)** – recycled asphaltic materials containing asphalt binder and aggregate. RAM may be RAP only or a combination of RAP and RAS for purposes of this test procedure. (*Currently limited to RAP and RAS*).

4. PROCEDURES – ACP Plants

4.1 General

The quantity of dry aggregate (after adding lime, if appropriate) and dry RAM as measured by the belt scales, the amount of asphalt as measured by the plant meter system, and the quantity of dry RAS, lime, mineral filler, fibers, liquid additive, or any other additive as measured by an appropriate meter for a predetermined period of time are used to determine the percentage of the appropriate constituent in the mixture.

The intent of the procedure presented in this section is to verify calibration of the RAM, RAS, lime, mineral filler, or fiber meters on a daily basis.

For Commercial ACP Plants where the procedures described herein are deemed impractical the following process shall be used:

- a) The ACP supplier will submit, in writing, a plan for verifying and documenting calibration of all appropriate meters on a daily basis.
- b) The Engineer and Region Quality Assurance Coordinator shall review, work with the supplier to modify if necessary, and approve the proposed plan.
- c) The supplier will perform the agreed upon process for ODOT contracts.

4.2 Plant Calibration

4.2.1 Standard Plants

Calibrate the plant aggregate belt scales, RAM belt scale, RAS belt scale, asphalt meter, and any other meters according to ODOT TM 322 prior to the beginning of paving. Make the results of the calibration available at the asphalt plant for review by the Engineer.

4.2.2 Plants Equipped with Calibration Tank on Load Cells

Plants which have the capability of producing for short periods of time from a calibration tank which can be weighed using load cells or a scale are not required to conduct the meter calibration in ODOT TM 322. Calibrate the weighing device using the standard required for plant scale calibration.

4.2.3 Storage of Mixture in Silo's

Develop a system to determine the quantity of mixture in the silos at the beginning and end of the day if any. This value will be used to adjust the total weight of mixture produced in a day.

4.3 Sublot Requirements (Form 734-2277)

4.3.1 - Determine the moisture content of the combined aggregate from the cold feed according to AASHTO T 255/265 and the moisture content from the RAM cold feed according to AASHTO T 329 for each sublot. RAS feed on an independent metered cold feed; determine the moisture content for the RAS according to AASHTO T 329.

4.3.2 - For each sublot as required by the acceptance program random number sampling schedule, record the asphalt, aggregate, RAM, RAS (if appropriate), lime (if appropriate), mineral filler (if appropriate), fiber (if appropriate), liquid additive (if appropriate), or any other additive used for a period of 15 ± 2 minutes.

This is accomplished by recording the totalizer readings at the beginning and end of the selected time period and subtracting, or by obtaining the results of the plant printout over the required period. Record the plant moisture settings of all the materials used by the plant for the selected time period.

4.3.3 - Determine the actual dry weight of aggregate according to the following formulas:

Convert “dry” weight of aggregate as measured by the plant to “actual wet” weight using the following formula:

$$\text{Plant "Dry" Weight} \times \left[1 + \frac{\text{Plant Moisture Setting, percent}}{100} \right]$$

Example:

$$\begin{aligned} \text{Plant "Dry" Weight of Aggregate} &= 163.4 \text{ tons} \\ \text{Plant Moisture Setting, \%} &= 3.2 \end{aligned}$$

$$\text{"Actual Wet" Weight of Aggregate} = 163.4 \times \left[1 + \frac{3.2}{100} \right] = 168.6 \text{ tons}$$

Convert “Actual Wet” weight of aggregate to “Actual Dry” weight of aggregate using the following formula:

$$\frac{(\text{"Actual Wet" Weight of Aggregate})}{1 + (\text{Sublot Aggregate Moisture Content, Percent}/100)}$$

Example:

$$\begin{aligned} \text{"Actual Wet" Weight of Aggregate} &= 168.6 \text{ tons} \\ \text{Sublot Aggregate Moisture Content, \%} &= 3.6 \end{aligned}$$

$$\text{"Actual Dry" Weight of Aggregate} = \frac{168.6}{1 + (3.6/100)} = \frac{168.6}{1.036} = 162.7 \text{ tons}$$

4.3.4 Determine the actual dry weight of RAM and/or RAS (if appropriate), according to the formulas given in Section 4.3.3 using weights and moisture content of RAM and/or RAS in place of the weights of aggregate.

4.3.5 Calculate the percent asphalt content using the following formula:

$$\frac{(\text{Weight of Asphalt}) \times 100}{(\text{Wt. of Asphalt}) + (\text{"Actual Dry" Weight of Aggregate})}$$

Example:

Weight of Asphalt = 10.72 tons

“Actual Dry” Weight of Aggregate = 162.7 tons

$$\text{Asphalt Content, \%} = \frac{10.72 \times 100}{10.72 + 162.7} = 6.18$$

NOTE: When materials such as mineral filler or fibers are added to the plant but not weighed by the final aggregate belt scale, the above formula will need to be modified as necessary to account for the additional materials.

4.3.6 - Calculate the percent RAM using the following formula:

$$\frac{(\text{“Actual Dry” Weight of RAM}) \times 100}{(\text{“Actual Dry” Weight of RAM}) + (\text{“Actual Dry” Weight of Aggregate})}$$

4.3.7 - If appropriate, calculate the percent RAS using the following formula:

$$\frac{(\text{“Actual Dry” Weight of RAS}) \times 100}{(\text{“Actual Dry” Weight of RAS}) + (\text{“Actual Dry” Weight of RAP}) + (\text{“Actual Dry” Weight of Aggregate})}$$

4.3.8 If appropriate, calculate the percent lime using the following formula:

$$\frac{(\text{Weight of Lime}) \times 100}{(\text{“Actual Dry” Weight of Aggregate}) - (\text{Weight of Lime})}$$

NOTE: The percent of lime is based on dry weight of virgin aggregate only. The “Actual Dry” Weight of Aggregate in the above equation would not include any mineral filler or fibers.

4.3.9 - When applicable, calculate the percent mineral filler, percent fibers, and/or percent liquid additive using the particular plant configuration and meter set up as necessary to compare the appropriate percentages with the job mix formula requirements.

4.3.10 - Determine the percent binder replacement as follows:

Calculate the percent virgin asphalt content using the following formula:

$$\frac{(\text{Weight of Asphalt}) \times 100}{(\text{Weight of Asphalt}) + (\text{“Actual Dry” Weight of RAS}) + (\text{“Actual Dry” Weight of RAP/RAM}) + (\text{“Actual Dry” Weight of Aggregate})}$$

Determine the total percent asphalt content according to AASHTO T 308.

Calculate the percent binder replacement using the following formula:

$$\frac{((\text{Total Percent Asphalt}) - (\text{Percent Virgin Asphalt})) \times 100}{(\text{Total Percent Asphalt})}$$

4.4 Daily Total Requirements (Form 734-2401 ACP)

4.4.1 Belt Scale and Meter Totalizers

Record the asphalt, aggregate, RAM, RAS (if appropriate), lime (if appropriate), mineral filler (if appropriate), fiber (if appropriate), liquid additive (if appropriate), or any other additive totalizer readings at the beginning and the end of each days production.

Record the plant settings for aggregate moisture, RAM moisture, and RAS moisture (if appropriate) used throughout the day. Document this information on form 734-2401 ACP.

4.4.2 Waste: Weigh and record the material measured by the plant belt scales and meters that did not get weighed by the plant truck scales (wasted) (this could include material generated from the production facility).

4.4.2.1 For purposes of determining waste for comparison of meters with physical inventory at the end of each day, material wasted due to plant start-ups, shut-downs, or other operations shall be evaluated as follows: 50% of the total wasted weight will be considered “uncoated aggregate waste” with no asphalt coating and 50% will be considered “mix waste” which is coated with the average asphalt content calculated for the day based on physical inventory. Enter these weights in the appropriate locations on form 734-2401 ACP.

4.4.3 Total “Dry” Material Weighed by Meters (Plant): Determine the total weight of “dry” material weighed by the meters for the day’s production using the following formula:

(Wt. of Asphalt) + (“Actual Dry” Wt of Aggregate) + (“Actual Dry” Wt of RAM) + (“Actual Dry” Wt of RAS) – (Uncoated Aggregate Waste)

NOTE: *When materials such as mineral filler, fibers, or RAS are added to the plant but not weighed by a belt scale, the above formula will need to be modified as necessary to account for the additional materials.*

4.5 Total Mixture Produced by Inventory (Truck Scale & Tank)

4.5.1 Total “Wet” Mixture Produced

Determine the total weight of “wet” mixture produced during the day from the truck invoices, this could include ACP mixture “sold to others”. Add to this the total “mix waste” determined from section 4.4.2. Calculate the total “wet” mixture produced using the following formula:

Total “Wet” Mixture = Wt. from Invoices + “Mix Waste”

4.5.2 Total “Dry” Mixture Produced

Determine the total weight of dry mixture produced during the day using the following formula:

$$\frac{\text{(Total “Wet” Mixture)}}{1 + (\text{Average Mixture Moisture, Percent}/100)}$$

4.6 Asphalt Content by Inventory (Form 734-2401 ACP)

4.6.1 Liquid Asphalt on Hand

Determine the gallons of asphalt on hand in the tanks prior to the start of production. Convert the gallons at tank temperature to weight (tons) at 60°F by multiplying the gallons from the tank chart by the appropriate temperature correction factor from column A in the attached table 2.03 and using the specific gravity identified on the asphalt invoice.

Example:

$$\begin{aligned} \text{Gallons of Asphalt} &= 2734.8 \\ \text{Temperature, } F &= 309 \\ \text{Correction Factor} &= 0.9158 \end{aligned}$$

$$\text{Gallons of Asphalt at } 60^{\circ}\text{F} = 2734.8 \times 0.9158 = 2504.5$$

Convert gallons of asphalt at 60°F to weight (tons) using the following formula:

$$\frac{\text{(gallons of Asphalt at } 60^{\circ}\text{F)} \times \text{(Asphalt Specific Gravity at } 60^{\circ}\text{F)}}{239.9 \text{ gallons/ton}}$$

Example:

$$\begin{aligned} \text{Volume of Asphalt at } 60^{\circ}\text{F} &= 2503.5 \text{ gallons} \\ \text{Asphalt Specific Gravity at } 60^{\circ}\text{F} &= 1.027 \end{aligned}$$

$$\text{Weight of Asphalt} = \frac{2503.5 \times 1.027}{239.9} = 10.72 \text{ tons}$$

4.6.2 Liquid Asphalt Delivered

Total the weight of liquid asphalt delivered to the asphalt plant for the production day. It is recommended that each transport be weighed prior to and after unloading to verify the actual delivered weight.

4.6.3 Liquid Asphalt Used

Add the weight of liquid asphalt on hand at the beginning of the day to the weight of liquid asphalt delivered and subtract the weight of liquid asphalt on hand at the end of the day. The answer gives the quantity of liquid asphalt used that day based on inventory. Reduce this amount by the quantity of liquid asphalt that was removed from the tank and did not enter the plant. This could include liquid asphalt removed for tack or other purposes.

Example:

Weight of Asphalt on Hand at Start of Production = 96.40 tons
Weight of Asphalt Delivered during Day = 124.80 tons
Weight of Asphalt on Hand at End of Production = 61.40 tons

Weight of Asphalt Used = $96.4 + 124.8 - 61.4 = 159.80$ tons

4.7 ACP Recordation System Verification

On a daily basis compare the total “dry weight” of materials measured by the plant meters (“Plant”) from Section 4.4.3 with the total “dry” weight of mixture from Section 4.5.2 according to the equation below. If the difference exceeds ± 1.0 percent, recalibrate the plant. ***The Engineer may waive this requirement for small production days where less than 1000 tons is produced.***

$$\frac{(\text{Total Dry Weight of Mixture} - \text{Total “Dry” Weight of Materials from Meters}) \times 100}{\text{Total “Dry” Weight of Mixture}}$$

Perform a second calculation comparing weight of asphalt as measured by the asphalt meter to the weight of asphalt used by inventory according to the equation below. If the difference is less than or equal to $\pm 0.5\%$, then the asphalt meter is in calibration and only the belt scales need to be recalibrated. If the difference exceeds $\pm 0.5\%$, then all meters and scales need recalibration.

$$\frac{(\text{Total Weight of Asphalt from Inventory} - \text{Total Weight of Asphalt by Meters}) \times 100}{\text{Total Weight of Asphalt by Inventory}}$$

5. PROCEDURES – EAC PLANTS

5.1 General

The quantity of dry aggregate, as measured by the belt scale, and the amount of emulsified asphalt measured by the plant metering system for a predetermined period of time are used to determine the percentage of emulsified asphalt being added to the dry aggregates. Minor variations will be allowed in this method for a particular type of plant operation as appropriate with the approval of the Engineer.

5.2 Plant Calibration

Calibrate the plant aggregate belt scales and asphalt meter according to ODOT TM 322 prior to the beginning of paving. Make the results of the calibration available at the EAC plant for review by the Engineer. Recalibrate the plant when the comparison of the recordation data and plant inventory is outside the limits established in this procedure.

5.3 Daily Total Requirements

5.3.1 Belt Scale and Meter Totalizers

Record the asphalt and aggregate totalizer readings at the beginning and the end of each day's production. Record the plant setting for aggregate moisture used throughout the day. This data will be used to determine the total quantity of material produced for comparison with the plant inventory data.

5.3.2 Waste

Weigh and record the mass of material measured by the plant belt scales and meters that did not get weighed by the plant truck scales (wasted) (this could include materials sent to the road and material generated from the production facility). All waste shall be itemized as to type and associated weight, i.e. start-up and shut-down, dust rejection, spilled material etc.

An alternative means of determining the mass of wasted materials may be proposed to the Engineer, in writing, when daily weighing of waste is determined to be impractical.

5.3.2.1 - For purposes of determining waste for comparison of meters with physical inventory at the end of each day, material wasted due to plant start-ups, shut-downs, or other operations shall be evaluated as follows: 50% of the total wasted mass will be considered "uncoated aggregate waste" with no asphalt coating and 50% will be considered "mix waste" which is coated with the average asphalt content calculated for the day based on physical inventory. Enter these weights in the appropriate locations on form 734-2401.

5.3.2.2 - For purposes of determining waste for comparison of meters with physical inventory at the end of each day, material wasted due to rejection on the grade or elsewhere will be considered “mix waste” which is coated with the average asphalt content calculated for the day based on physical inventory. Combine this value with the “mix waste” determined in 5.3.2.1 and enter the new value in the appropriate location on form 734-2401.

5.3.2.3 - Calculate the amount of waste liquid asphalt using the “mix waste” masses from Sections 5.3.2.1 and 5.3.2.2 and the average asphalt content calculated for the day from the “BY TANK %Pb” box on form 734-2401. Enter the waste emulsified asphalt in the “deductions after beginning inventory” box on form 734-2043. Document calculations in the “Waste Deduction Calculations” portion of form 734-2043.

5.3.3 Asphalt Content by Meters

Calculate the percent emulsified asphalt by meters for the day’s production according to the following formula:

$$\frac{(\textit{Weight of Asphalt}) \times 100}{(\textit{Actual Dry Weight of Aggregate}) - \textit{Uncoated Agg Waste}}$$

Calculate the “Actual Dry” weight of aggregate using the daily totalizer readings for the aggregate, plant aggregate moisture setting, and average of the subplot aggregate cold feed moisture tests for the day using the process described in Section 5.4.3.

5.4 Sublot Requirements

5.4.1 - Determine the moisture content of the combined aggregate from the cold feeds according to AASHTO T 255/265 for each subplot.

5.4.2 - For each subplot as required by the acceptance program random number sampling schedule, record the asphalt and aggregate used for a period of 15 ± 2 minutes. This is accomplished by recording the totalizer readings at the beginning and end of the selected time period and subtracting, or by obtaining the results of the plant printout over the required period. Record the plant setting for aggregate moisture used for the selected time period.

5.4.3 - Determine the “actual dry” weight of aggregate according to the following:

5.4.3.1 Convert “dry” weight of aggregate as measured by the plant to “actual wet” weight using the following formula:

$$\textit{Plant "Dry" Weight} \times \left[1 + \frac{\textit{Plant Moisture Setting, percent}}{100} \right]$$

Example:

Plant "Dry" Weight of Aggregate = 163.4 tons
Plant Moisture Setting, % = 3.2

$$\text{"Actual Wet" Weight of Aggregate} = 163.4 \times \left[1 + \frac{3.2}{100} \right] = 168.6 \text{ tons}$$

- 5.4.3.2 Convert "Actual Wet" weight of aggregate to "Actual Dry" weight of aggregate using the following formula:

$$\frac{\text{"Actual Wet" Weight of Aggregate}}{1 + (\text{Sublot Aggregate Moisture Content, Percent}/100)}$$

Example:

"Actual Wet" Weight of Aggregate = 168.6 tons
Sublot Aggregate Moisture Content, % = 3.6

$$\text{"Actual Dry" Weight of Aggregate} = \frac{168.6}{1 + (3.6/100)} = \frac{168.6}{1.036} = 162.7 \text{ tons}$$

Determine the volume of emulsified asphalt used for a base temperature of 60°F by multiplying the gallons from the meter by the appropriate temperature correction factor from attached Table B.1.

Example:

Gallons of Asphalt = 2560.4
Temperature, F = 149
Correction Factor = 0.97775

$$\text{Gallons of Asphalt at } 60^{\circ}\text{F} = 2560.4 \times 0.97775 = 2503.4$$

NOTE: Some plant meters measure the quantity of asphalt directly in mass. If this is the case, skip Sections 5.4.5 and 5.4.6 and proceed directly to Section 5.4.7.

- 5.4.5 Convert gallons of emulsified asphalt at 60°F to tons using the following formula:

$$\frac{\text{(gallons of Asphalt at } 60^{\circ}\text{F)} \times \text{(Asphalt Specific Gravity at } 60^{\circ}\text{F)}}{239.9 \text{ gallons/ton}}$$

Example:

Volume of Asphalt at 60°F = 2503.4 gallons
Asphalt Specific Gravity at 60°F = 1.027

$$\text{Weight of Asphalt} = \frac{2503.4 \times 1.027}{239.9} = 10.72 \text{ tons}$$

5.4.6 Calculate the percent asphalt content using the following formula:

$$\frac{(\text{Weight of Asphalt}) \times 100}{(\text{“Actual Dry” Wt. Of Aggregate})}$$

Example:

$$\begin{aligned} \text{Weight of Asphalt} &= 10.72 \text{ tons} \\ \text{“Actual Dry” Weight of Aggregate} &= 158.33 \text{ tons} \end{aligned}$$

$$\text{Asphalt Content, \%} = \frac{10.72 \times 100}{158.33} = 6.77$$

5.5 Asphalt Content by Inventory

5.5.1 Emulsified Asphalt on Hand

Determine the gallons of asphalt on hand in the tanks prior to the start of production. Convert the gallons at tank temperature to weight (tons) at 60°F using the formulas in Section 7.4.4 and 7.4.5.

5.5.2 Emulsified Asphalt Delivered

Total the weight of liquid asphalt delivered to the asphalt plant for the production day. It is recommended that each transport be weighed prior to and after unloading to verify the actual delivered weight.

5.5.3 Emulsified Asphalt Used

Add the weight of emulsified asphalt on hand at the beginning of the day to the weight of emulsified asphalt delivered and subtract the weight of emulsified asphalt on hand at the end of the day. The answer gives the quantity of emulsified asphalt used that day based on inventory.

Reduce this amount by the quantity of emulsified asphalt that was removed from the tank and did not enter the plant. This could include liquid asphalt removed for tack or other purposes.

Example:

$$\begin{aligned} \text{Weight of Asphalt on Hand at Start of Production} &= 96.40 \text{ tons} \\ \text{Weight of Asphalt Delivered During Day} &= 124.80 \text{ tons} \\ \text{Weight of Asphalt on Hand at End of Production} &= 61.40 \text{ tons} \end{aligned}$$

$$\text{Weight of Asphalt Used} = 96.4 + 124.8 - 61.4 = 159.80 \text{ tons}$$

5.5.4 Total Mixture Produced by Inventory

5.5.4.1 Total “Wet” Mixture Produced

Determine the total weight of “wet” mixture produced during the day from the truck invoices. Add to this the total “mix waste” determined from Sections 5.3.2.1 and 5.3.2.2. Calculate the total “wet” mixture produced using the following formula:

$$\text{Total “Wet” Mixture} = \text{Weight from Invoices} + \text{“Mix Waste”}$$

5.5.4.2 Total “Dry Aggregate” from Mixture Produced

Determine the total “Dry Aggregate” from the mixture produced for the day from the following formula:

$$\frac{(\text{Total “Wet” Mixture} - \text{Emulsified Asphalt Used})}{1 + (\text{Average Aggregate Moisture Content, Percent}/100)}$$

5.5.4.3 Asphalt Content by Inventory

Determine the percent asphalt content by inventory of the mixture by the following formula:

$$\frac{(\text{Emulsified Asphalt Used}) \times 100}{\text{Total “Dry Aggregate” from Mixture Produced}}$$

Example:

$$\begin{aligned} \text{Emulsified Asphalt Used} &= 159.80 \text{ tons} \\ \text{Total “Dry Aggregate” from Mixture Produced} &= 2663.80 \text{ tons} \end{aligned}$$

$$\text{Asphalt Content by Inventory, \%} = \frac{159.80 \times 100}{2663.80 - 159.80} = 6.38$$

5.6 EAC Recordation System Verification

On a daily basis compare the percent asphalt content from the meter data from Section 5.3.3 to the percent asphalt content determined by the inventory method from Section 5.5.4.3. If the difference exceeds ± 0.20 percent, recalibrate the plant. For those production days when the above tolerance is exceeded, the asphalt content for each subplot used for acceptance as determined from the meter method will be adjusted by the difference determined in this verification process for that day.

Calculate the asphalt content correction value (difference) from the following formula:

Asphalt Content Correction, % =

Asphalt Content by Inventory, % - Asphalt Content by Meter, %

If Asphalt Content Correction Difference (%) $\leq \pm 0.20\%$, then Correction = 0.0%

If Asphalt Content Correction Difference (%) $> \pm 0.20\%$, then adjust subplot asphalt content values according to:

Adjusted Asphalt Content for Sublot n, % =

Asphalt Content for Sublot n by meter, % + Asphalt Content Correction, %

Example:

Asphalt Content by Daily Inventory, % = 6.38

Asphalt Content by Daily Meter, % = 6.65

Asphalt Content by Sublots for the Daily Production:

Sublot 1-4	6.77%
Sublot 1-5	6.62%
Sublot 1-6	6.61%

Asphalt Content Correction, % = $6.38 - 6.65 = -0.27$

Difference $-0.27\% > \pm 0.20\%$, therefore apply correction to daily sublots

Adjusted Sublot Asphalt Contents:

Sublot 1-4	$6.77\% + (-0.27\%) = 6.50\%$
Sublot 1-5	$6.62\% - 0.27\% = 6.35\%$
Sublot 1-6	$6.61\% - 0.27\% = 6.34\%$

Table 2.03 Temperature-Volume Corrections for Asphalt (continued)

Observed Temperature, °F	Volume Correction Factor to 60° F ¹		Observed Temperature, °F	Volume Correction Factor to 60° F ¹		Observed Temperature, °F	Volume Correction Factor to 60° F ¹		Observed Temperature, °F	Volume Correction Factor to 60° F ¹	
	A	B		A	B		A	B		A	B
0	1.0211	1.0241	70	0.9965	0.9950	140	0.9723	0.9686	210	0.9486	0.9418
1	1.0208	1.0237	71	0.9962	0.9956	141	0.9720	0.9682	211	0.9483	0.9414
2	1.0204	1.0233	72	0.9958	0.9952	142	0.9716	0.9678	212	0.9479	0.9410
3	1.0201	1.0229	73	0.9955	0.9948	143	0.9713	0.9674	213	0.9476	0.9407
4	1.0197	1.0225	74	0.9951	0.9944	144	0.9710	0.9670	214	0.9472	0.9403
5	1.0194	1.0221	75	0.9948	0.9940	145	0.9706	0.9666	215	0.9469	0.9399
6	1.0190	1.0217	76	0.9944	0.9936	146	0.9703	0.9662	216	0.9466	0.9395
7	1.0186	1.0213	77	0.9941	0.9932	147	0.9699	0.9659	217	0.9462	0.9391
8	1.0183	1.0209	78	0.9937	0.9929	148	0.9696	0.9655	218	0.9459	0.9388
9	1.0179	1.0205	79	0.9934	0.9925	149	0.9693	0.9651	219	0.9456	0.9386
10	1.0176	1.0201	80	0.9930	0.9921	150	0.9689	0.9647	220	0.9452	0.9380
11	1.0172	1.0197	81	0.9927	0.9917	151	0.9686	0.9643	221	0.9449	0.9376
12	1.0169	1.0193	82	0.9923	0.9913	152	0.9682	0.9639	222	0.9446	0.9373
13	1.0165	1.0189	83	0.9920	0.9909	153	0.9679	0.9635	223	0.9442	0.9369
14	1.0162	1.0185	84	0.9916	0.9905	154	0.9675	0.9632	224	0.9439	0.9365
15	1.0158	1.0181	85	0.9913	0.9901	155	0.9672	0.9628	225	0.9436	0.9361
16	1.0155	1.0177	86	0.9909	0.9897	156	0.9669	0.9624	226	0.9432	0.9358
17	1.0151	1.0173	87	0.9909	0.9893	157	0.9665	0.9620	227	0.9429	0.9354
18	1.0148	1.0168	88	0.9902	0.9889	158	0.9662	0.9616	228	0.9426	0.9350
19	1.0144	1.0164	89	0.9899	0.9885	159	0.9658	0.9612	229	0.9422	0.9346
20	1.0141	1.0160	90	0.9896	0.9881	160	0.9655	0.9609	230	0.9419	0.9343
21	1.0137	1.0156	91	0.9892	0.9877	161	0.9652	0.9605	231	0.9416	0.9339
22	1.0133	1.0152	92	0.9889	0.9873	162	0.9648	0.9601	232	0.9412	0.9335
23	1.0130	1.0148	93	0.9885	0.9869	163	0.9645	0.9597	233	0.9409	0.9331
24	1.0126	1.0144	94	0.9882	0.9865	164	0.9641	0.9593	234	0.9405	0.9328
25	1.0123	1.0140	95	0.9878	0.9861	165	0.9638	0.9589	235	0.9402	0.9324
26	1.0119	1.0136	96	0.9875	0.9857	166	0.9635	0.9585	236	0.9399	0.9320
27	1.0116	1.0132	97	0.9871	0.9854	167	0.9631	0.9582	237	0.9395	0.9316
28	1.0112	1.0128	98	0.9868	0.9850	168	0.9628	0.9578	238	0.9392	0.9313
29	1.0109	1.0124	99	0.9864	0.9846	169	0.9624	0.9574	239	0.9389	0.9309
30	1.0105	1.0120	100	0.9861	0.9842	170	0.9621	0.9570	240	0.9385	0.9305
31	1.0102	1.0116	101	0.9857	0.9838	171	0.9618	0.9566	241	0.9382	0.9301
32	1.0098	1.0112	102	0.9854	0.9834	172	0.9614	0.9562	242	0.9379	0.9298
33	1.0095	1.0108	103	0.9851	0.9830	173	0.9611	0.9559	243	0.9375	0.9294
34	1.0091	1.0104	104	0.9847	0.9826	174	0.9607	0.9555	244	0.9372	0.9290
35	1.0088	1.0100	105	0.9844	0.9822	175	0.9604	0.9551	245	0.9369	0.9286
36	1.0084	1.0096	106	0.9840	0.9818	176	0.9601	0.9547	246	0.9365	0.9283
37	1.0081	1.0092	107	0.9837	0.9814	177	0.9597	0.9543	247	0.9362	0.9279
38	1.0077	1.0088	108	0.9833	0.9810	178	0.9594	0.9539	248	0.9359	0.9275
39	1.0074	1.0084	109	0.9830	0.9806	179	0.9590	0.9536	249	0.9356	0.9272
40	1.0070	1.0080	110	0.9826	0.9803	180	0.9587	0.9532	250	0.9352	0.9268
41	1.0067	1.0076	111	0.9823	0.9799	181	0.9584	0.9528	251	0.9349	0.9264
42	1.0063	1.0072	112	0.9819	0.9795	182	0.9580	0.9524	252	0.9346	0.9260
43	1.0060	1.0068	113	0.9816	0.9791	183	0.9577	0.9520	253	0.9342	0.9257
44	1.0056	1.0064	114	0.9813	0.9787	184	0.9574	0.9517	254	0.9339	0.9253
45	1.0053	1.0060	115	0.9809	0.9783	185	0.9570	0.9513	255	0.9336	0.9249
46	1.0049	1.0056	116	0.9806	0.9779	186	0.9567	0.9509	256	0.9332	0.9245
47	1.0046	1.0052	117	0.9802	0.9775	187	0.9563	0.9505	257	0.9329	0.9242
48	1.0042	1.0048	118	0.9799	0.9771	188	0.9560	0.9501	258	0.9326	0.9238
49	1.0038	1.0044	119	0.9795	0.9767	189	0.9557	0.9498	259	0.9322	0.9234
50	1.0035	1.0040	120	0.9792	0.9763	190	0.9553	0.9494	260	0.9319	0.9231
51	1.0031	1.0036	121	0.9788	0.9760	191	0.9550	0.9490	261	0.9316	0.9227
52	1.0028	1.0032	122	0.9785	0.9756	192	0.9547	0.9486	262	0.9312	0.9223
53	1.0024	1.0028	123	0.9782	0.9752	193	0.9543	0.9482	263	0.9309	0.9219
54	1.0021	1.0024	124	0.9778	0.9748	194	0.9540	0.9478	264	0.9306	0.9216
55	1.0017	1.0020	125	0.9775	0.9744	195	0.9536	0.9475	265	0.9302	0.9212
56	1.0014	1.0016	126	0.9771	0.9740	196	0.9533	0.9471	266	0.9299	0.9208
57	1.0010	1.0012	127	0.9768	0.9736	197	0.9530	0.9467	267	0.9296	0.9205
58	1.0007	1.0008	128	0.9764	0.9732	198	0.9526	0.9463	268	0.9293	0.9201
59	1.0003	1.0004	129	0.9761	0.9728	199	0.9523	0.9460	269	0.9289	0.9197
60	1.0000	1.0000	130	0.9758	0.9725	200	0.9520	0.9456	270	0.9286	0.9194
61	0.9997	0.9996	131	0.9754	0.9721	201	0.9516	0.9452	271	0.9196	0.9190
62	0.9993	0.9992	132	0.9751	0.9717	202	0.9513	0.9448	272	0.9279	0.9186
63	0.9990	0.9988	133	0.9747	0.9713	203	0.9509	0.9444	273	0.9276	0.9182
64	0.9986	0.9984	134	0.9744	0.9709	204	0.9506	0.9441	274	0.9273	0.9179
65	0.9983	0.9980	135	0.9740	0.9705	205	0.9503	0.9437	275	0.9269	0.9175
66	0.9979	0.9976	136	0.9737	0.9701	206	0.9499	0.9433	276	0.9266	0.9171
67	0.9976	0.9972	137	0.9734	0.9697	207	0.9496	0.9429	277	0.9263	0.9168
68	0.9972	0.9968	138	0.9730	0.9693	208	0.9493	0.9425	278	0.9259	0.9164
69	0.9969	0.9964	139	0.9727	0.9690	209	0.9489	0.9422	279	0.9256	0.9160

Table 2.03 Temperature-Volume Corrections for Asphalt (continued)

Observed Temperature, °F	Volume Correction Factor to 60° F ¹		Observed Temperature, °F	Volume Correction Factor to 60° F ¹		Observed Temperature, °F	Volume Correction Factor to 60° F ¹		Observed Temperature, °F	Volume Correction Factor to 60° F ¹	
	A	B		A	B		A	B		A	B
280	0.9253	0.9157	335	0.9073	0.8956	390	0.8896	0.8760	445	0.8721	0.8567
281	0.9250	0.9153	336	0.9070	0.8952	391	0.8892	0.8756	446	0.8718	0.8564
282	0.9246	0.9149	337	0.9066	0.8949	392	0.8889	0.8753	447	0.8715	0.8560
283	0.9243	0.9146	338	0.9063	0.8945	393	0.8886	0.8749	448	0.8714	0.8557
284	0.9240	0.9142	339	0.9060	0.8942	394	0.8883	0.8746	449	0.8709	0.8554
285	0.9236	0.9138	340	0.9057	0.8938	395	0.8880	0.8742	450	0.8705	0.8550
286	0.9233	0.9135	341	0.9053	0.8934	396	0.8876	0.8738	451	0.8702	0.8547
287	0.9230	0.9131	342	0.9050	0.8931	397	0.8873	0.8735	452	0.8699	0.8543
288	0.9227	0.9127	343	0.9047	0.8927	398	0.8870	0.8731	453	0.8696	0.8540
289	0.9223	0.9124	344	0.9044	0.8924	399	0.8867	0.8728	454	0.8693	0.8536
290	0.9220	0.9120	345	0.9040	0.8920	400	0.8864	0.8724	455	0.8690	0.8533
291	0.9217	0.9116	346	0.9037	0.8917	401	0.8861	0.8721	456	0.8687	0.8529
292	0.9213	0.9113	347	0.9034	0.8913	402	0.8857	0.8717	457	0.8683	0.8526
293	0.9210	0.9109	348	0.9031	0.8909	403	0.8854	0.8717	458	0.8680	0.8522
294	0.9207	0.9105	349	0.9028	0.8906	404	0.8851	0.8710	459	0.8677	0.8519
295	0.9204	0.9102	350	0.9024	0.8902	405	0.8848	0.8707	460	0.8674	0.8516
296	0.9200	0.9098	351	0.9021	0.8899	406	0.8845	0.8703	461	0.8671	0.8512
297	0.9197	0.9094	352	0.9018	0.8895	407	0.8841	0.8700	462	0.8668	0.8509
298	0.9194	0.9097	353	0.9015	0.8891	408	0.8838	0.8696	463	0.8665	0.8505
299	0.9190	0.9087	354	0.9011	0.8888	409	0.8835	0.8693	464	0.8661	0.8502
300	0.9187	0.9083	355	0.9008	0.8884	410	0.8832	0.8689	465	0.8658	0.8498
301	0.9186	0.9080	356	0.9005	0.8881	411	0.8829	0.8686	466	0.8655	0.8495
302	0.9181	0.9076	357	0.9002	0.8877	412	0.8826	0.8682	467	0.8652	0.8492
303	0.9177	0.9072	358	0.8998	0.8873	413	0.8822	0.8679	468	0.8649	0.8488
304	0.9174	0.9069	359	0.8995	0.8870	414	0.8819	0.8675	469	0.8646	0.8485
305	0.9171	0.9065	360	0.8992	0.8866	415	0.8816	0.8672	470	0.8643	0.8481
306	0.9167	0.9061	361	0.8989	0.8863	416	0.8813	0.8668	471	0.8640	0.8478
307	0.9164	0.9058	362	0.8986	0.8859	417	0.8810	0.8665	472	0.8636	0.8474
308	0.9161	0.9054	363	0.8982	0.8856	418	0.8806	0.8661	473	0.8633	0.8471
309	0.9158	0.9050	364	0.8979	0.8852	419	0.8803	0.8658	474	0.8630	0.8468
310	0.9154	0.9047	365	0.8976	0.8848	420	0.8800	0.8654	475	0.8627	0.8464
311	0.9151	0.9043	366	0.8973	0.8845	421	0.8797	0.8651	476	0.8624	0.8461
312	0.9148	0.9039	367	0.8949	0.8841	422	0.8794	0.8647	477	0.8621	0.8457
313	0.9145	0.9036	368	0.8966	0.8838	423	0.8791	0.8644	478	0.8618	0.8454
314	0.9141	0.9032	369	0.8963	0.8834	424	0.8787	0.8640	479	0.8615	0.8451
315	0.9138	0.9028	370	0.8960	0.8831	425	0.8784	0.8637	480	0.8611	0.8447
316	0.9135	0.9025	371	0.8957	0.8827	426	0.8781	0.8633	481	0.8608	0.8444
317	0.9132	0.9021	372	0.8953	0.8823	427	0.8778	0.8630	482	0.8605	0.8440
318	0.9128	0.9018	373	0.8950	0.8820	428	0.8775	0.8626	483	0.8602	0.8437
319	0.9125	0.9014	374	0.8947	0.8816	429	0.8772	0.8623	484	0.8599	0.8433
320	0.9122	0.9010	375	0.8944	0.8813	430	0.8768	0.8619	485	0.8596	0.8430
321	0.9118	0.9007	376	0.8941	0.8809	431	0.8765	0.8616	486	0.8593	0.8427
322	0.9115	0.9003	377	0.8937	0.8806	432	0.8762	0.8612	487	0.8590	0.8423
323	0.9112	0.9000	378	0.8934	0.8802	433	0.8759	0.8609	488	0.8587	0.8420
324	0.9109	0.8996	379	0.8931	0.8799	434	0.8756	0.8605	489	0.8583	0.8416
325	0.9105	0.8992	380	0.8928	0.8795	435	0.8753	0.8602	490	0.8580	0.8413
326	0.9102	0.8989	381	0.8924	0.8792	436	0.8749	0.8599	491	0.8577	0.8410
327	0.9099	0.8985	382	0.8921	0.8789	437	0.8746	0.8595	492	0.8574	0.8406
328	0.9096	0.8981	383	0.8918	0.8784	438	0.8743	0.8592	493	0.8571	0.8403
329	0.9092	0.8978	384	0.8915	0.8781	439	0.8740	0.8588	494	0.8568	0.8399
330	0.9089	0.8974	385	0.8912	0.8777	440	0.8737	0.8585	495	0.8565	0.8396
331	0.9086	0.8971	386	0.8908	0.8774	441	0.8734	0.8581	496	0.8562	0.8393
332	0.9083	0.8967	387	0.8905	0.8770	442	0.8731	0.8578	497	0.8559	0.8389
333	0.9079	0.8963	388	0.8902	0.8767	443	0.8727	0.8574	498	0.8556	0.8386
334	0.9076	0.8960	389	0.8899	0.8763	444	0.8724	0.8571	499	0.8553	0.8383
									500	0.8549	0.8379

¹ Use column A for factors asphalts with API gravity at 60°F of 14.9° or less or with specific gravity 60/60°F of 0.967 or higher. Use column B factors for asphalts with API gravity at 60°F from 15.0° to 34.9° or with specific gravity 60/60°F from 0.850 to 0.966.

ODOT TM 322

Method of Test for

ASPHALT CONCRETE PLANT CALIBRATION PROCEDURE FOR:

**Hot Mix Asphalt Concrete (ACP)
and
Emulsified Asphalt Concrete (EAC)**

SCOPE:

This test method is established to specify procedures for calibrating the weighing and measuring devices used in the asphalt materials processing plant.

Plant calibration is required in order to accept asphalt content, RAP content, RAS content, or RAM content, liquid additives content, hydrated lime content, mineral filler content, or fiber content by meter reading as allowed or required in the specifications, special provisions, or by Contract Change Order.

TERMINOLOGY:

Reclaimed Asphalt Pavement (RAP) – removed and/or processed pavement materials containing asphalt binder and aggregate.

Recycled Asphalt Shingles (RAS) – tear-off or manufacturer waste shingle product materials containing asphalt and fine aggregate and fiberglass material.

Recycled Asphalt Material (RAM) – agency approved recycled asphaltic materials containing asphalt binder and aggregate. RAM may be RAP only or a combination of RAP and RAS for purposes of this test procedure. (Currently limited to RAP and RAS).

CALIBRATION PROCEDURE:

1. General:

Perform the plant calibration procedures described herein for each weighing or measuring device used to proportion each size of aggregate, asphalt cement, RAM, RAS, and any other liquid or dry additives used in the asphalt plant.

Submit copies of appropriate forms fully documenting all readings, measurements, and calculations to the Engineer for review and approval prior to starting production.

In lieu of using the ODOT TM 322 procedures described herein, the Contractor may submit in writing prior to start of production, accompanied by appropriate forms, an alternative procedure for plant calibration. If approved by the Engineer, the alternative plant calibration procedures may be used.

2 Scale Specifications:

Provide scales meeting the requirements of applicable specifications.

3. Asphalt Meter Calibration:

The asphalt meter can be checked by two methods:

Alternate I:

- a. Weigh the delivery truck or trailer on the platform scales.
- b. Record the asphalt meter reading.
- c. Off-load the truck or trailer through the asphalt meter into the storage tank.
- d. Record the meter reading and determine quantity using the meter calibration factor previously established by the contractor.
- e. Weigh the empty truck or trailer.
- f. Record the temperature of the delivered asphalt.
- g. Use the appropriate conversion factor to convert the delivered asphalt to gallons if the meter measurement is in volume.
- h. Determine percent of error between weighed material and measured material through meter.
- i. The asphalt meter result shall be within 0.5 percent for ACP plants and 1.0 percent for EAC plants of the known gallons or tons. If not, recalibrate the meter.

Alternate II:

- a. Weigh a container or tank truck such as an asphalt distributor truck capable of holding a minimum of 1000 gallons.
- b. Record the plant asphalt meter reading.
- c. Pump a minimum of 1000 gallons through the meter into the container or truck.
- d. Record the plant asphalt meter reading (weight or volume). If the plant meters measure volume, calculate the gallons delivered to the truck using the meter calibration factor previously established by the contractor.
- e. Weigh the container or truck.
- f. Record the asphalt temperature.
- g. Convert the gross weight of the asphalt to gallons if the meter measurement is in volume.
- h. Compare the weighed material to the quantity delivered through the asphalt meter.
- i. The asphalt meter result shall be within 0.5 percent for ACP plants and 1.0 percent for EAC plants of the known gallons or tons. If not, recalibrate the meter.

4. **Virgin Aggregate Belt Scale Calibration:**

Warm up the conveyor belt scale by operating for at least 30 minutes. Make a zero-load check run of empty belt while operating.

Alternate I:

- a. Empty all aggregate bins and conveyors.
- b. Weigh a **minimum** of 8 tons of aggregate.
- c. Pass the weighed material over the recorded belt scale.

- d. Repeat this process twice:

For ACP plants, perform the process once with the plant set at low tons per hour production and once with the plant set at high tons per hour production.

For EAC plants, set the plant at the planned production rate for both cycles.

- e. Depending on the type of belt scale totalizer used, time the passage of the material and multiply by the belt scale factor tons/hr., or record the belt totalizer before and after passage of the material.
- f. Compare the belt scale reading to the weight of material.
- g. The belt scale results shall be within 0.5 percent for ACP plant and 1.0 percent for EAC plants of the known amount. If not, recalibrate the belt scale.

Alternate II:

- a. Record the belt scale totalizer reading. If there is no totalizer, begin timing belt passage.
- b. For ACP plants, operate the conveyor with aggregates:
 - 1. 4 minutes at low tons per hour production
 - 2. 2 minutes at high tons per hour production
- c. For EAC plants, operate the conveyor with aggregates for 2 to 6 minutes at the planned production rate (time is determined by how long it takes to fill one or more haul vehicles).
- d. Divert this material into a truck or portable container.
- e. Determine gross weight of material on the platform scale.
- f. Depending on the type of belt scale totalizer used, stop timing the passage of the material and multiply by the belt scale factor tons/hr, or record the belt totalizer after passage of the material.
- g. Compare the belt scale quantity to weighed quantity. The belt scale results shall be within 0.5 percent for ACP plants and 1.0 percent for EAC plants of the known amount. If not, recalibrate the belt scale.

5. **RAM Belt Scale Calibration:**

Follow the procedure for the virgin aggregate belt scale calibration (Section 4). **Compare the RAM belt scale quantity to weighed quantity. The belt scale results shall be within 0.5 percent of the known amount. If not, recalibrate the RAP belt scale.**

6. **Liquid Additives Calibration:**

Follow the procedure for asphalt meter calibration (Section 3); only substitute an appropriate sized container or gallons of additive for testing.

The plant device results shall be within 0.5 percent of the known amount. If not, recalibrate the meter.

7. **RAS, Mineral Filler or Hydrated Lime Additive:**

Follow the procedure for virgin aggregate belt scale calibration (Section 4), except apply the procedure to the vane feeder, belt scale, or other metering device as appropriate, and weigh out a minimum of 100 lb of RAS, mineral filler or lime into an appropriate sized container .

The plant device results shall be within 0.5 percent of the known amount. If not, recalibrate the device.

8. **Fiber Additives:**

Calibrate the metering system for fiber additives according to the fiber additive equipment manufacturer's recommendation. Provide documentation of the procedure to the Engineer.

ODOT TM 323
DETERMINATION OF CALIBRATION FACTORS
For
DETERMINING THE ASPHALT CEMENT CONTENT OF ASPHALT CONCRETE
PAVEMENT
BY THE
IGNITION METHOD

1. SCOPE

- 1.1 This test method covers the determination of a Calibration Factor (CF) used in determining asphalt cement content of ACP paving mixtures with or without reclaimed asphalt pavement (RAP) or recycled asphalt shingles (RAS) by the ignition method according to AASHTO T308. This test method also includes determination of gradation correction factors.
- 1.2 The values stated in metric units are to be regarded as the standard.
- 1.3 This method may involve hazardous materials, operations, and equipment. This method does not purport to address all of the safety problems associated with its use. It is the responsibility of whoever uses this method to consult and establish appropriate safety and health practices and determine the applicability of regulatory limitations prior to use.

2. REFERENCED DOCUMENTS

AASHTO T308 Determining the Asphalt Binder Content of Hot Mix Asphalt (HMA) by the Ignition Method.

AASHTO T30 Mechanical Analysis of Extracted Aggregate

ODOT Contractor Mix Design Guidelines for Asphalt Concrete and Supplemental Test Procedures for ACP and EAC.

3. Terminology

Calibration Factor (C_F) - The average difference between the known (batched) asphalt binder content and calculated asphalt cement content from incineration results.

ACP - Asphalt Concrete Pavement

Reclaimed Asphalt Pavement (RAP) – removed and/or processed pavement materials containing asphalt binder and aggregate.

Recycled Asphalt Shingles (RAS) – tear-off or manufacturer waste shingle product materials containing asphalt and fine aggregate and fiberglass material.

Recycled Asphalt Material (RAM) – agency approved recycled asphaltic materials containing asphalt binder and aggregate. RAM may be RAP only or a combination of RAP and RAS for purposes of this test procedure. (Currently limited to RAP and RAS).

4. SUMMARY OF TEST METHOD

Four samples of ACP with a known asphalt content and gradation are batched. The asphalt cement in two, possibly four of the samples is incinerated according to AASHTO T308 and the asphalt binder content is calculated. The difference between the known (batched) asphalt binder content and calculated asphalt cement content (from incineration results) is determined for each sample. The average of the difference is the Calibration Factor (C_F) applied to production tests according to AASHTO T308. The gradations of the incinerated samples are determined and compared with a “blank” sample that has not been incinerated.

Establish a Calibration Factor (C_F) for each JMF. This procedure must be performed for every ignition furnace on a project and for each JMF before any acceptance or verification testing is completed.

The CMTD, who develops the JMF for a project will provide properly batched samples to each of the field QC and QA laboratories and to the ODOT Central Laboratory for the CAT1 to use in calculating a Calibration Factor (C_F) and gradation correction factors. An alternate CMTD may provide the required calibration samples, if approved by the Engineer.

A new calibration factor is required if the source or grade of the asphalt cement changes, if the source of RAP or RAS changes, if a different ignition furnace is used, or for a new JMF. A new calibration factor shall be determined for each JMF prior to its first use every calendar year. Calibration factors for a JMF shall be “transferred” from project to project during a calendar year, unless one of the above conditions applies.

5. APPARATUS

Supply apparatus as required by AASHTO T308. Use the same ignition furnace for the calibration that will be used for production testing.

6. CALIBRATION SAMPLE PREPARATION – MIXTURES WITHOUT RAM or RAS

- 6.1 Sample the aggregate, mineral filler, lime, fibers, and other appropriate additives to be used for the calibration specimens from material designated for use on the project. Use the brand and grade of asphalt cement designated for the JMF.

6.2 Prepare six calibration mixture samples at the JMF asphalt cement content and gradation and with the appropriate proportions of mineral filler, lime, fibers or other additive included in the JMF.

Batch the specimens according to standard industry procedures, modified as follows:

- Batch each sample separately and according to the tolerances in Section 6.4.
- If Lime is required by the JMF, add according to TM 316 (see note 1).
- Before adding asphalt cement randomly select one sample and set it aside as the “blank” sample. See Section 6.3.
- Provide sample sizes meeting the requirements of AASHTO T 308
- Mix and discard one of the remaining five samples. The purpose of this sample is to “butter” the mixing bowl.
- For the remaining four (or more) samples, tare the mixing bowl and weigh the mixing bowl again after the mixture is removed from the bowl. The empty bowl must be within ± 1 gram of the previous tare weight.
- Individually identify each calibration sample and supply documentation showing the actual weights of aggregate, asphalt cement, mineral filler, lime, fibers or any other additive for each sample and resultant actual calculated asphalt cement content for each sample. Also provide documentation for each sample verifying that the empty bowl weight after mixing is within ± 1 gram of the empty bowl weight prior to mixing. An example batch form (2327CB) is available under Section 3 of the MFTP.

Note 1: Errors in batching or failure to take great care in ensuring that all sample material is removed from the mixing bowl can result in significant errors in the Calibration Factor.

These errors can affect the statistical pay factor for the Contractor and the quantity of asphalt cement the Agency pays for. Every effort should be taken to ensure that batching and mixing errors are minimized.

The amount of lime in a calibration sample can substantially affect the calibration factor, so extra care shall be taken to ensure the proper amount is batched.

6.3 The “blank” sample as selected in 6.2 shall have the same gradation, but no asphalt cement shall be added. This “blank” sample will be used to establish correction factors for the aggregate gradations. The “blank” sample is not burned.

6.4 Batch each sample according to the JMF target values within the following tolerances:

Batching Tolerances “Virgin Aggregate and Add Asphalt Cement”

<u>Sieve Size</u>	<u>Allowable Difference</u>
Larger than (No. 8)	$\pm 3.0\%$
Size (No. 8)	$\pm 2.0\%$
Larger than (No. 200) and smaller than (No. 8)	$\pm 1.0\%$
Size (No. 200) and smaller	$\pm 0.5\%$
Asphalt Cement	$\pm 0.10\%$

7. CALIBRATION SAMPLE PREPARATION - MIXTURES WITH RAM or RAS

If allowed by the Engineer, the percentage of asphalt cement in RAM or RAS (Pbr) and the gradation of the residual aggregate from the recycled material(s) may be determined by an alternative method. If an alternative method is allowed, skip to Section 7.7.

- 7.1 Sample the aggregate, reclaimed material (RAP, RAM & RAS), mineral filler, lime, fibers, and other appropriate additives to be used for the calibration specimens from material designated for use on the project. Use the brand and grade of virgin asphalt cement designated for the JMF.
- 7.2 Batch a minimum of five samples of each reclaimed material, as appropriate, according to the gradation of the reclaimed material in the JMF. Batch each sample so that it consists of 100% reclaimed material. Follow the table below for required number of samples:

Material Type	Number of RAP samples	Number of RAS samples	Number of RAM samples
RAP	5	0	0
RAS	0	5	0
RAM	0	0	5
Unblended RAM (RAP and RAS to be blended during production)	5	5	0

Batch the RAM samples according to standard industry practices with a sample size appropriate for AASHTO T308. Note that for infrared furnaces, the higher set temperature “burn profile” may be necessary to provide complete combustion of the sample.

For RAS Only samples the sample size shall be between 500 and 750 grams.

- 7.3 Test each sample of 100% RAM according to AASHTO T308 Method A or Method B (with a 60 minute burn time) to determine the cement content of each.

For RAS samples, the incineration time will be determined using AASHTO T 308, including steps 10-14 of Method B. Method A may also be used utilizing the internal scale to indicate a mass loss per Step 10. For both Method A & B, an ending mass loss percentage of 0.03 percent will be utilized to indicate the completion of the burn.

- 7.4 Determine the average total percent loss of the five samples. Subtract 0.5% from the average total percent loss. By definition, a Calibration Factor of 0.5% shall be the standard for 100% reclaimed materials, since it is difficult and time consuming to determine the Calibration Factor for mixtures comprised of 100% reclaimed materials. **See Section 9 for example calculations.**
- 7.5 The value(s) determined in Section 7.4 will be considered the percentage of asphalt cement in the reclaimed material(s) (**P_{br}**).
- 7.6 Perform sieve analysis on the incinerated five reclaimed material samples according to AASHTO T30. Average the five gradations for each reclaimed material type. The average gradation will be considered the gradation for the individual material type. Each gradation shall be provided with the calibration samples.
- 7.7 Prepare six calibration mixture samples at the JMF asphalt cement content and gradation with the appropriate proportions of reclaimed material, mineral filler, lime, fibers or any other additive. Batch the specimens according to standard industry procedures, modified as given below. The actual asphalt cement content used to calculate the Calibration Factor will be a combination of **P_{br}** for each reclaimed material and the virgin asphalt cement added.
- Batch each sample separately. The batching of the virgin aggregate shall meet the tolerances outlined in Section 6.4.
 - If Lime is required by the JMF, add according to TM 316 (see note 2).
 - Provide sample sizes meeting the requirements of AASHTO T308.
 - Before adding reclaimed materials or asphalt cement randomly select one sample and set it aside as the “blank” sample. See Section 7.8.
 - For each sample, combine and thoroughly dry-mix the virgin aggregate and reclaimed material(s) before adding virgin asphalt cement.
 - Mix and discard one of the remaining five samples. The purpose of this sample is to “butter” the mixing bowl.
 - For the remaining four (or more) samples, tare the mixing bowl and weigh the mixing bowl again after the mixture is removed from the bowl. The empty bowl must be within ± 1 gram of the previous tare weight.
 - Individually identify each calibration sample and supply documentation showing the actual weights of aggregate, reclaimed material(s), virgin asphalt cement, mineral filler, lime, fibers or any other additive for each sample and resultant actual (calculated) asphalt cement content for each sample. Also provide documentation for each sample verifying that the empty bowl weight after mixing was within ± 1 gram of the empty bowl weight prior to mixing. An example batch form (2327CB) is available under Section 3 of the MFTP.

Note 2: Errors in batching or failure to take great care in ensuring that all sample material is removed from the mixing bowl can result in significant errors in the Calibration Factor.

These errors can affect the statistical pay factor for the Contractor and the quantity of asphalt cement the Agency pays for. Every effort should be taken to ensure that batching and mixing errors are minimized.

The amount of lime in a calibration sample can substantially affect the calibration factor, so extra care shall be taken to ensure the proper amount is batched.

- 7.8 For the “blank” sample, virgin aggregate (including mineral filler, lime, fibers or any other additive) and reclaimed material(s) in the proper proportions will be provided separately. The virgin aggregate shall be batched within the tolerances of section 6.4. Incinerate the reclaimed material(s) provided for the “blank” sample according to AASHTO T308 Method A or Method B (with a 60-minute burn time). Gradations for the residual aggregate from the reclaimed material(s) and the virgin aggregate (including mineral filler, lime, fibers or any other additive) shall be determined separately according to AASHTO T 30 and AASHTO T27/11.

Mathematically combine the results of the residual aggregate from the reclaimed material(s) and the virgin aggregate (including mineral filler, lime, fibers or any other additive) to determine the overall gradation result. Provide separate sieve analysis results for the residual aggregate from the reclaimed material(s), the virgin aggregate component, and the overall computed gradation, see Note 3.

Note 3: Reporting of the separate gradations provides a check of the batching process and ensures the virgin aggregate component, in a JMF containing RAP, has been accurately accounted for according to the JMF percentages.

8. CALIBRATION PROCEDURE (MIXTURES WITH OR WITHOUT RECLAIMED MATERIALS)

- 8.1 Freshly mixed samples may be tested immediately. Cooled calibration samples must be preheated to $(340 \pm 9^\circ\text{F})$ for 120 ± 5 minutes to remove moisture.
- 8.2 Test two of the samples according to AASHTO T308 Method A or Method B (with a 60 minute burn time) to determine the cement content of each. **The method used for calibration must be used for production testing.** The incinerator shall be kept at 1000°F even if the correction factor exceeds 0.5%.
- 8.3 If the difference between the cement contents of the two samples exceeds 0.15 percent, perform two additional tests and, from the four tests, discard the high and low result. Determine the Calibration Factor from the two original or remaining results, as appropriate. Calculate the difference between the actual and measured cement contents for each sample.

The Calibration Factor (C_F) is the average of the differences expressed in percent by mass of the ACP mix. **See Section 8 for example calculations**

- 8.4 Perform sieve analysis on the residual aggregates from the incinerated samples used to calculate the Calibration Factor according to AASHTO T30. Average the two results. Perform sieve analysis on the “blank” sample according to AASHTO T30.
- 8.5 Determine the difference in gradation between the “blank” sample and the average of the two incinerated calibration samples.

The gradation correction factor for each sieve size is the difference between the result from the “blank” sample and the average of the two incinerated calibration samples to the nearest 0.1%. **See Section 8 for example calculations.**

If the correction factor for any single sieve size exceeds the allowable difference for that sieve established in the following table, contact the Engineer. The Engineer will determine whether or not to apply the gradation correction factors for all sieves.

Gradation Difference Tolerances

<u>Sieve</u>	<u>Allowable Difference</u>
Sizes larger than (No. 8)	±5.0%
Size (No. 8)	±4.0%
Sizes larger than (No. 200) and smaller than (No. 8)	±2.0%
Size (No. 200) and smaller	±1.0%

9. CALCULATIONS

CALIBRATION FACTOR (Section 7.3)

$$C_F = \frac{[(D1 - P1) + (D2 - P2)]}{2}$$

D1, D2 = Total sample loss in percent in calibration samples 1 and 2.

P1, P2 = Actual asphalt cement (%) added in calibration samples 1 and 2.

C_F = Calibration Factor

IF: D1 = 6.52 %
 D2 = 6.62 %
 P1 and P2 = 6.20 %

THEN: C_F = 0.37 %

GRADATION CORRECTION FACTORS (Section 7.5)

<u>Sieve Size</u>	<u>Blank Gradation %</u>	<u>Average of two Incinerated samples %</u>	<u>Correction Factor %</u>
(3/4")	97.0	94.0	+3.0
(1/2")	86.3	85.9	+0.4
(3/8")	77.3	75.8	+1.5
(No. 4)	46.5	47.3	-0.8
(No. 8)	31.2	32.0	-0.8
(No. 30)	12.4	14.2	-1.8
(No. 200)	6.0	7.2	-1.2

FINAL GRADATION CALCULATION (Section 7.5)

Sieve Size	Incinerated Washed Gradation %	Correction Factor %	Final Gradation
(3/4")	94.6	+3.0	98
(1/2")	86.9	+0.4	87
(3/8")	54.3	+1.5	56
(No. 4)	47.8	-0.8	47
(No. 8)	32.5	-0.8	32
(No. 30)	15.3	-1.8	14
(No. 200)	8.6	-1.2	7.4

PERCENT ASPHALT CEMENT IN 100% RECLAIMED MATERIAL (Section 6.4)

$$P_{br} = (D1 + D2 + D3 + D4) / 4 - 0.5\%$$

D1, D2, D3, D4 = Total loss in the ignition furnace (from Section 6.3)

0.5% = standard mix calibration factor for all reclaimed materials

$$P_{br} = [(6.6 + 6.1 + 5.9 + 6.2) / 4] - 0.5\%$$

$$P_{br} = 5.7\%$$

ODOT TM 326

Method of Test for

Preparation of Field Compacted Gyratory Specimens Determination of Average G_{mb} for ACP Volumetric Calculations

1. SCOPE

This method covers preparation of field compacted specimens using the Superpave™ gyratory compactor. This method conforms, in general, to AASHTO T 312 supplemented herein to conform to Oregon Quality Assurance program standard practices.

AASHTO T 312 is presented in Annex A of this procedure.

2. SIGNIFICANCE AND USE

Gyratory specimens are used to measure the Bulk Specific Gravity (G_{mb}) of a compacted ACP mixture. The G_{mb} is used to calculate the volumetric properties of a compacted ACP mixture.

3. APPARATUS

Provide apparatus meeting the requirements of Section 4 of AASHTO T 312.

In addition, provide the following:

3.1 Containers – Provide shallow, flat, rigid metal pans large enough to accommodate a 5,000 gram sample spread to a depth of 1” to 2”, for uniform heating/conditioning of the ACP mixture.

3.2 Thermometers – Digital or dial-type thermometers with metal stems or probes for determining temperature of aggregates, binder and HMA between 50° F and 450° F. **Non-contact thermometers are not acceptable.**

3.3 Funnel - A funnel or other device for transferring AC mixture from containers into molds is suggested. The device must not cause segregated specimens.

3.4 Oven – Forced air, ventilated, or convection oven capable of maintaining the temperature surrounding the sample at $325 \pm 9^\circ\text{F}$.

4. STANDARDIZATION

Standardize the gyratory compactor according to Section 6 of AASHTO T 312.

Verify calibration of the ram pressure, angle of gyration, gyration frequency, and specimen height measurement system using procedures and at frequencies recommended by the manufacturer. Provide a log book with each compactor documenting calibrations and calibration checks performed and make it available for review by Agency representatives. The log book shall contain the brand, model, and serial number of the compactor. As a minimum, the log book shall also include the types of calibration checks performed, results of the checks, actions taken to correct problems, date performed, and the name of the technician performing the procedures.

The load cell provided by the manufacturer for standardization must be checked on an annual basis with a traceable device according to the ODOT Laboratory Certification Program. The angle of gyration shall be based on internal measurements per AASHTO T 344 and the calibration verified according to the manufacturer's recommendations.

5. PREPARATION OF APPARATUS

Prepare apparatus for use according to Section 7 of AASHTO T 312 modified as necessary per the manufacturer's recommendations. Specimen height must be recorded according to the requirements of Section 4.1.1 of AASHTO T 312.

The number of gyrations required (N_{design}) will be provided on the Job Mix Formula (JMF).

6. TEST PROCEDURE

6.1 At least one hour prior to compacting specimens, place all specimen mold assemblies, sample container, scoop/spoons, etc. in an oven and heat to within the placement temperature range given on the JMF.

6.2 Two gyratory specimens are required per Mix Design Verification test. Obtain a sample of ACP mixture per AASHTO T 168 (typically this requires a weight of 10,000 gram or more). **(Note: This sample is in addition to mix required for other quality control testing).**

The sample size for each specimen must be sufficient to produce compacted specimens with a final height of 115 ± 5 mm. Specimens with heights outside this range will be discarded and not used for volumetric calculations. Immediately re-sample the ACP mixture per AASHTO T 168 (typically this requires a weight of 10,000 gram or more). The sample size may be given on the JMF.

If not, the sample size may be estimated by the following:

$$\text{Sample Size (grams)} = \frac{G_{mb} \times 2026}{1.03}$$

Where: G_{mb} = Bulk Specific Gravity at the target given on the JMF

Or

$$\text{Sample Size (grams)} = G_{mm} \times N$$

<i>N Factor</i>	
3/4"	1853.4
1/2"	1872.9
3/8"	1892.4

Where: G_{mm} = Maximum Specific Gravity at the target given on the JMF.
N Factor = Based on Nominal Maximum size of ACP.

6.3 Reduce the sample according to AASHTO R 47 to obtain the desired specimen sample sizes.

6.4 Weigh the appropriate sample size into a container meeting the requirements of Section 3.1, spread to a depth of 1" to 2" and place in oven. Repeat for the second specimen.

6.4.1 Oven Temperature - The temperature of the oven should be set such that the samples, when compacted, reach a temperature within the "Placement Temperature" range given on the project JMF. The temperature of the oven shall at no time exceed the maximum "Mixing Temperature" on the JMF.

NOTE: Maintaining required temperatures is of critical importance in preparing gyratory specimens. Every effort should be made during the procedure to minimize heat loss to the sample and to maintain the required minimum temperature. Loss of heat may result in significant additional time required to heat the sample to proper temperature. Variability in compaction temperatures between specimens can result in unacceptable variability in G_{mb} test results.

6.4.2 Mixture Aging (to allow for asphalt absorption and to heat to compaction temperature) – Bring the two samples to the “Placement Temperature” range by uniform heating in an oven. The samples should be conditioned for a time period of 1 hour minimum to 1 hour 30 minutes maximum from the time they are sampled. A sample to be tested for maximum specific gravity (G_{mm}) according to AASHTO T 209 should be conditioned for the same period of time, unless altered per the yellow sheet provisions of AASHTO T 209. The aging time may be increased or decreased to better reflect the actual ACP storage time and haul time if approved by the Engineer.

6.5 After the conditioning time in Section 6.4.2 has expired, check the temperature of the material at several locations in the container. If it is within the “Placement Temperature” range, proceed with remaining steps. If it is too cool, continue heating to get the required temperature. Samples must be compacted within 3 hours of sampling or they will be discarded.

NOTE: Temperature differences within a sample can cause variable results. Select containers that meet the requirements of Section 3.1 and that will evenly heat the material to minimize temperature variability within a sample.

6.6 Load each sample into a mold and recheck the temperature of the mix, with a thermometer meeting Section 3.2 criteria, in the center of the mold to ensure that is in the proper range. Take care not to segregate the samples when loading material into the mold. Compact with N_{design} gyrations according to Section 9 of AASHTO T 312. Take care not to deform the specimen when extruding the sample and removing it from the compactor.

NOTE: It may be necessary to partially extrude the specimen from the mold and allow it to cool for a few minutes prior to final removal. Some mixes may deform or fall apart, especially at lower gyrations, if removed too hot resulting in erroneous measurements.

6.7 Place flat side down on a smooth and level surface, properly identify, and cool until the specimen reaches room temperature.

6.8 Determine the bulk specific gravity of each specimen according to AASHTO T166.

7. REPORTING

For each MDV test performed with a gyratory compactor, provide the following to the Agency:

- The specimen height for each compacted specimen.
- Temperature of each specimen at time of compaction.
- The time at which each sample was obtained and compacted.
- Provide G_{mb} calculations for each sample.
- Calculate the average of the two sample G_{mb} 's. The average will be used for volumetric calculations.
- Report volumetric calculations on a form approved by the Agency.

8. PROCEDURE FOR PRODUCTION VERIFICATION (QA) SAMPLES

This section covers procedures required for gyratory compaction of verification samples split and performed by the Contractor QC lab and Agency QA lab. The Contractor and Agency will perform ODOT TM 326 and the process described in this section for all verification samples obtained during the time Mix Design Verification (MDV) testing is being performed.

8.1 Perform applicable portions of Sections 4, 5, and 6 of this procedure, supplemented as follows:

8.1.1 Obtain sufficient material such that each laboratory can compact two specimens.

8.1.2 Reduce samples to the appropriate mass and place in containers immediately after sampling.

8.1.3 Allow each sample to cool to ambient temperature for a minimum of 12 hours. An alternative procedure for conditioning and compacting the samples will be allowed if agreed upon by the Contractor and the Region Quality Assurance Coordinator.

8.1.4 Heat the specimens to the JMF compaction range. Not to exceed the "Mixing Temperature" upper range on the JMF. Condition the AASHTO T 209 specimen according to T 209 criteria. Each specimen shall be in the oven no longer than 4 hours (3 hours if not reheated).

8.2 Provide documentation to the Agency according to Section 7 of this procedure.

ANNEX A

AASHTO T 312

Preparing and Determining the Density of Asphalt Mixture Specimens by Means of the Superpave Gyratory Compactor

AASHTO Designation: T 312/T 312-15

AASHTO TEST METHODS CANNOT BE INCLUDED ON ODOT'S WEBSITE DUE TO COPYRIGHT INFRINGEMENT.

TO GET COPIES OF THE TEST METHODS, YOU MAY ORDER A HARD COPY OF ODOT'S **MANUAL OF FIELD TEST PROCEDURES** OR YOU MAY ORDER THE LATEST **STANDARD SPECIFICATIONS FOR TRANSPORTATION MATERIALS AND METHODS OF SAMPLING AND TESTING** FROM AASHTO.

To order ODOT's *Manual of Field Test Procedures*, use the following web address:

<https://www.oregon.gov/ODOT/Forms/2ODOT/7345110.pdf>

To order AASHTO's *Standard Specifications for Transportation Materials and Methods of Sampling and Testing*, visit the [AASHTO Store website](#).

ODOT TM 327

Method of Test for

Correlation of Nuclear Gauge Readings and Determination of ACP Density Using Pavement Cores

1. SCOPE

This test method describes the test procedures for the correlation of the nuclear gauge readings, and the density of cores removed from the roadway. Cores removed from the roadway for the purpose of a correlation of a nuclear gauge, or for density testing shall represent a single JMF for each correlation.

2. APPARATUS

2.1. Nuclear Density Gauge Equipment - See AASHTO T 355, Apparatus

2.2. Coring Equipment – See AASHTO R 67, Apparatus

3. PROCEDURE CORE CORRELATION TO NUCLEAR GAUGE

When comparing the density of the core, determined by the Bulk Specific Gravity (G_{mb}) performed in accordance with AASHTO T-166, to the corresponding site of a nuclear density gauge reading, taken in accordance with AASHTO T 355, a correlation can be established. With the correlation, all gauge readings will be adjusted to match the in-place density based on the cores. The core correlation is gauge specific and must be obtained with no traffic allowed on the pavement between gauge readings and extraction of the core. All gauges that will be used on the project for testing the JMF represented by this process should be correlated to the core locations prior to removal of the core.

3.1 Site Location:

- 3.1.1. If traffic is allowed on the pavement before the gauge density measurements are completed, measurements shall be completed within 48 hours of paving or as allowed by the Engineer.
- 3.1.2. Traffic shall not be allowed in the test locations between the time gauge measurements are completed and cores are removed and holes back filled.
- 3.1.3. Select core locations that are not in the first 50' of the panel being tested or in the area of the ODOT TM 306 Control Strip initial point development.

3.1.4. The site locations shall meet the “Test Site Location” requirements above and be representative of the entire cross-section of the panel being paved. Representatives of the both the Contractor and the Quality Assurance unit shall agree on the core locations.

3.2. Either randomly identify 10 core locations on the proposed pavement to be tested in accordance with ODOT TM 400 Stratified Random Sampling or select core locations based on the “Chevron Pattern”.

The Contractor and the Engineer shall agree on the selected option.

3.2.1. Chevron Pattern- the Chevron Pattern is a pattern of ten core locations. The pattern starts on one side of the panel, approximately one foot from the edge of the panel, evenly space five locations, moving transversely across the panel with the fifth location being approximately one foot from the opposite edge. Then an additional five locations, similarly placed in a transverse pattern, move back to the starting edge. The core locations shall have a minimum longitudinal distance of 50 feet between each core.

The following “Chevron Pattern” Diagram is not to scale.

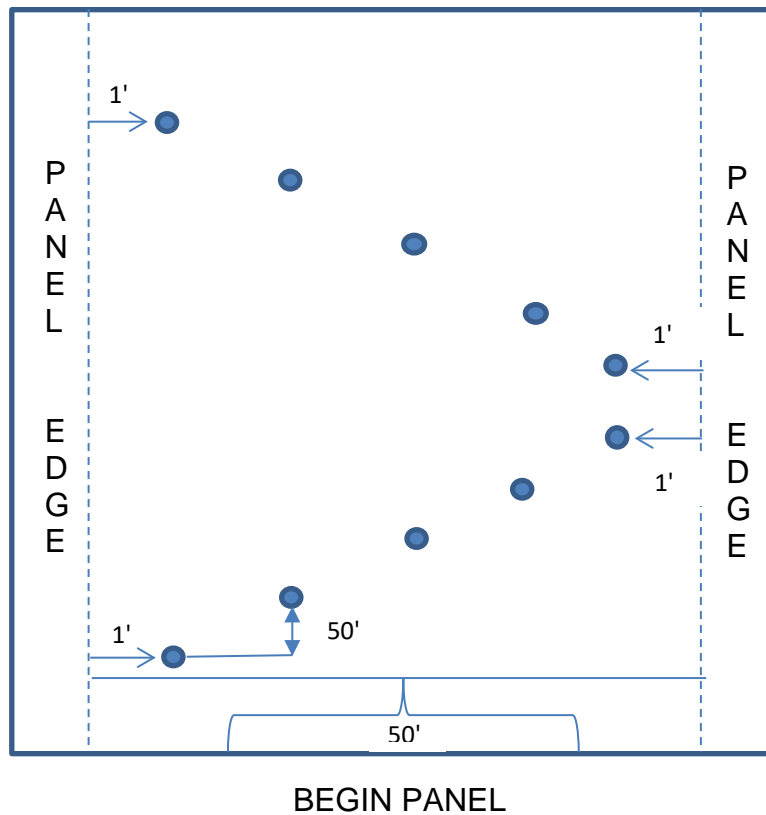

- 3.3. Perform Nuclear Gauge Testing in accordance with AASHTO T 355.
- 3.4. Core the location according to AASHTO R 67. Remove the core to a minimum depth of the lift being placed. The relative position of the core to the nuclear gauge readings for each test location shall be as illustrated in Figure 1. Extreme care shall be taken when extracting the cores, avoid such tools as pry-bars and screwdrivers as they will cause damage.

Figure 1

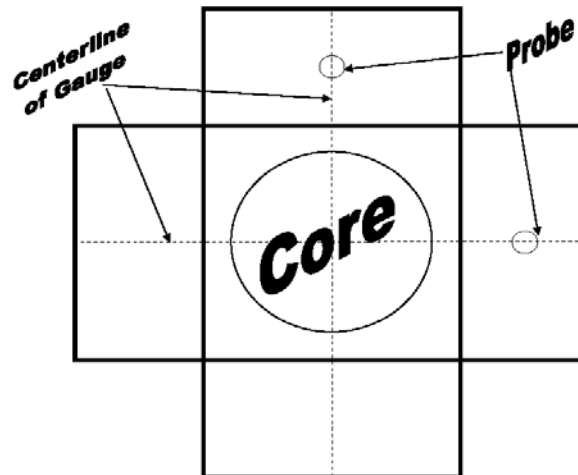

- 3.5. Separate the layer of ACP to be tested from the remainder of each core according to AASHTO R 67. In the event the tested layer is damaged the number of cores must meet the following conditions:
 - 3.5.1. If 8 to 10 cores are in good condition proceed with step 3.6.
 - 3.5.2. If less than 8 cores are in good condition, additional cores and gauge readings will need to be obtained such that an even number of cores are tested for both QC and QA; to achieve a minimum of 10 cores to be analyzed.
- 3.6. Once the cores have been separated the contractor will deliver half of the cores to the Quality Assurance unit and both parties will determine the Bulk Specific Gravity of the provided set according to AASHTO T-166.
- 3.7. Prior to the bulking operation measure and record each specimen's thickness to the nearest 1/8". Once the bulking process is completed both parties will provide nuclear gauge readings and bulk specific gravity test results to the Project Manager for determination of the correlation factor.

- 3.8. Calculate a correlation factor for the nuclear gauge reading as follows:
- 3.8.1. Determine the density of the cores by multiplying the bulk specific gravity obtained from AASHTO T 166 by 62.4 lb/ft^3 . Round this result to the nearest 0.1 lb/ft^3 .
 - 3.8.2. Calculate the difference between the core density and the average nuclear gauge density at each test site to the nearest 0.1 lb/ft^3 . Calculate the average difference and standard deviation of the differences for the entire data set to the nearest 0.1 lb/ft^3 .
 - 3.8.3. If the standard deviation of the differences is equal to or less than 2.5 lb/ft^3 , the correlation factor applied to the nuclear density gauge reading shall be the average difference calculated in 3.8.2.
 - 3.8.4. If the standard deviation of the differences is greater than 2.5 lb/ft^3 , the test site with the greatest variation from the average difference shall be eliminated from the data set. Then the data set properties and correlation factor recalculated following 3.8.2 and 3.8.3.
 - 3.8.5. If the modified data set meets the allowable and the number of cores remaining in the data set and if less than 8 cores remain additional cores and gauge readings will need to be obtained such that an equivalent number of cores are obtained for testing, for both QC and QA and to achieve a minimum of 10 cores to be analyzed. The minimum number of cores used to determine the correlation shall be 8.

3.9. Core Correlation Example:

	<u>Core results</u> from T 166:	<u>Average</u> <u>Gauge reading:</u>	<u>Difference:</u>	<u>X</u>	<u>X²</u>
1	144.9 lb/ft ³	142.1 lb/ft ³	2.8 lb/ft ³	-0.7	0.49
2	142.8 lb/ft ³	140.9 lb/ft ³	1.9 lb/ft ³	0.2	0.04
3	143.1 lb/ft ³	140.7 lb/ft ³	2.4 lb/ft ³	-0.3	0.09
4	140.7 lb/ft ³	138.9 lb/ft ³	1.8 lb/ft ³	0.3	0.09
5	145.1 lb/ft ³	143.6 lb/ft ³	1.5 lb/ft ³	0.6	0.36
6	144.2 lb/ft ³	142.4 lb/ft ³	1.8 lb/ft ³	0.3	0.09
7	143.8 lb/ft ³	141.3 lb/ft ³	2.5 lb/ft ³	-0.4	0.16
8	142.8 lb/ft ³	139.8 lb/ft ³	3.0 lb/ft ³	0.9	0.81
9	144.8 lb/ft ³	143.3 lb/ft ³	1.5 lb/ft ³	-0.6	0.36
10	143.0 lb/ft ³	141.0 lb/ft ³	2.0 lb/ft ³	-0.1	0.01
		Average Difference:	+2.1 lb/ft ³		

$$\text{Standard Deviation} = \sqrt{\frac{\sum X^2}{n-1}}$$

Where:

\sum = Sum

x = Difference from the average Difference

n-1 = number of data sets minus 1

Example: 10 – 1 = 9

$$\text{Standard Deviation} = \sqrt{\frac{2.50}{9}} = 0.53$$

The Sum of X² = 2.5 and the number of data sets = 9 for a computed standard deviation of 0.53. This is within the allowable 2.5 therefore no cores are eliminated, use the average difference from all ten cores.

3.10. Applying Correlation Example:

Reading #1: 141.5 lb/ft³

Reading #2: 140.1 lb/ft³ Two readings within tolerance? (YES)

Reading average: 140.8 lb/ft³

Core Correlation : +2.1 lb/ft³

Corrected reading: 142.9 lb/ft³

G_{mm} and maximum density from the FOP for AASHTO T 209:

G_{mm} = 2.466 => 2.466 X 62.4 => 153.9 lb/ft³

$$\frac{\text{Corrected Reading}}{\text{Maximum Density}} \times 100 = \% \text{ compaction} \qquad \frac{142.9}{153.9} \times 100 = 92.9\%$$

4. PROCEDURE DENSITY CORES

This procedure is used to determine the locations, density, and compaction of cores removed from the roadway. It is employed for third party resolution and for confirmation of failing verification of density.

- 4.1. Test Site location shall meet the 3.1 requirements listed above. Randomly identify 5 core locations representing the proposed pavement to be tested in accordance with ODOT TM 400 Stratified Random Sampling.
- 4.2. Core each location according to AASHTO R 67; remove the core to a minimum depth of the lift being evaluated. Extreme care shall be taken when extracting the cores, avoid such tools as pry-bars and screwdrivers as they will cause damage.
- 4.3. Separate the layer of ACP to be tested from the remainder of each core According to AASHTO R 67.
- 4.4. Determine the density of the cores according to AASHTO T 331, Standard Method of Test for Bulk Specific Gravity (G_m) and Density of Compacted Hot Mix Asphalt (HMA) Using Automatic Vacuum Sealing Method.
- 4.5. Determine the percent compaction for each core density using the MAMD done in accordance with ODOT TM 305 for the pavement being evaluated. Determine the subplot compaction by averaging the percent compaction of the 5 test locations per subplot.

5. REPORTING

5.1. Compaction by Nuclear Gauge

- Project Name and Number
- Project Manager and Contractor
- Bid Item for mix being placed
- Type of ACP being evaluated
- Mix Design Lab Number
- Design thickness of lift
- Nuclear Gauge Serial Number, Make & Model
- Panel width
- Rollers being used and Position in train
- Assigned Test Number for each location tested
- The date each location was tested
- The location of each test station and offset
- The lift of ACP location was tested
- The individual Nuclear Density reading at each test location
- Average Nuclear Density reading at each test location
- MAMD used for each test location
- The required Percent Compaction
- The Sublot Average Percent Compaction
- The Represented area i.e. Station to Station and Offset to Offset
- Technician's Name, Cert. number and signature

5.2. Core Correlation, provide the following information to the Agency:

- Project Name and Number
- Project Manager and Contractor
- Bid Item for mix being placed
- The date the cores were obtained
- The lift of ACP being evaluated
- Type of ACP being evaluated
- Mix Design Lab Number
- Nuclear Gauge Serial Number, Make & Model
- The individual Nuclear Density reading at each test location
- Average Nuclear Density reading at each core location
- Average thickness of each core to the nearest 1/8"
- Core density value and the following T-166 information:
 - Mass of core in air,
 - Mass of core in water
 - SSD mass of core
- Calculated Bulk Specific Gravity and Density
- Individual differences between average gauge densities and core densities
- Standard Deviation of the differences
- Indicate any data sets eliminated from use in the Correlation Factor
- Correlation Factor

- Document who performed the CDT, CAT-1 and QCCS work, name, cert number and signatures.
- ODOT form 2327-15 is available to perform the correlation calculations.

5.3. **Density of Cores**

- Project Name and Number
- Project Manager and Contractor
- Bid Item for mix being placed
- The date each core location was sampled
- The lift of ACP location was sampled
- Type of ACP being evaluated
- Mix Design Lab Number
- Design thickness of lift
- Core density value and the following T-166 information:
 - Mass of core in air,
 - Mass of core in water
 - SSD mass of core
- Core thickness
- MAMD used for each test location
- The individual Core percent compaction at each test location
- The average percent compaction per subplot
- Document the CDT, and CAT-1 full names and cert. numbers.

ODOT TM 335

PRESENCE OF HARMFUL MATERIALS IN RECYCLED ASPHALT SHINGLES

1. Scope.

This method covers the procedure to be used for the determination of harmful materials (e.g. nails, glass, rubber, soil, brick, tars, paper, plastic, wood chips, metal flashing, and other material not used in the manufacturing of asphalt shingles) in a sample of recycled asphalt shingles (RAS).

2. Apparatus

- 2.1. Balance or scale accurate to within 0.1 percent of the sample mass or readable to 0.1 g and meeting the requirements of AASHTO M 231.
- 2.2. Forced draft (preferred), ventilated or convection oven
- 2.3. Magnet rated with a minimum rating of 10 lbs of pull.

3. Sample Preparation

- 3.1. Sample per AASHTO R 90.
- 3.2. Reduce to testing size per AASHTO R 76.
- 3.3. The minimum mass shall conform to Table 1 of AASHTO T 27/11.

4. Procedure - General.

- 4.1. Prepare a companion moisture sample and dry the sample following AASHTO T 255/T 265, Directions for Drying Aggregate, under the Controlled section.
- 4.2. Determine and record the wet mass of the entire test sample to the nearest 0.1 gram, designate as W_{wt} for calculation in 5.1.
- 4.3. Spread the sample to a depth of a 1/2-inch or less on a clean non-magnetic surface.
- 4.4. Pass the magnet over the entire sample between 1/8 and 1/2 inch above the sample.
- 4.5. Determine and record the weight of the remaining sample not retained by the magnet. Designate as "A" for calculation in 5.1.
- 4.6. Calculate the weight of the metal fragments according to section 5.1.
- 4.7. Sieve the remaining material over the 3/8 inch, the No. 4, the No. 8, and the No. 30 sieves. Sieve the material for 10 ± 2 min.

- 4.8. Discard the portion of material passing the No. 30 sieve.
- 4.9. Check the material retained on each sieve for all deleterious content including but not limited to wood, paper, plastic and other material not used in the manufacturing of asphalt shingles:
 - 4.9.1. Spread the portion of the sample retained on each sieve individually, out in a pan large enough to examine the individual particles carefully.
 - 4.9.2. Separate and remove the deleterious matter from the sample by visual inspection.
 - 4.9.3. Weigh all deleterious matter removed from the RAS sample retained on each sieve to the nearest 0.1 g and record each weight as $N_{3/8}$, N_4 , N_8 , and N_{30} respectively for use in calculation in Section 5.2.

5. Calculations

5.1. Calculate total dry weight of sample, W_t as follows:

$$W_t = W_{wt} - \left(W_{wt} \times \frac{M_i - M_f}{M_f} \right)$$

Where:

- M_i = initial weight of companion moisture sample, g
- M_f = final weight of companion moisture sample, g
- W_{wt} = total weight of wet sample, g

5.2. Calculate the weight of metal fragments to the nearest 0.1 grams as follows:

$$M = W_T - A$$

Where:

- M = weight of material retained by the magnet, g
- W_T = total dry weight of sample, g
- A = weight of material not retained by the magnet, g

5.3. Calculate the percent by weight of deleterious material in the sample:

$$P = \frac{M + N_{3/8} + N_4 + N_8 + N_{30}}{W_T} \times 100$$

Where:

P = percent of deleterious matter by weight

M = weight of material retained by magnet, g

$N_{3/8}$ = weight of deleterious substance retained on the 3/8 inch sieve, g

N_4 = weight of deleterious substance retained on the No. 4 sieve, g

N_8 = weight of deleterious substance retained on the No. 8 sieve, g

N_{30} = weight of deleterious substance retained on the No. 30 sieve, g

W_T = total dry weight of sample, g

6. Report

6.1. Mass of sample

6.2. Mass harmful material

6.3. Percentage of harmful materials (0.1%)

ODOT TM 400

Method of Test for

Determining Random Sampling and Testing locations

Significance

This procedure is used to determine random sampling and test location for various field tested materials used in highway construction. Use of accepted random sampling techniques is intended to minimize any bias on the part of the person taking the sample. Testing and sampling locations and procedures are just as important as testing. For test results or measurements to be meaningful, it is necessary that the sampling locations be selected at random, typically by use of a table of random numbers. Other approved techniques yielding a system of randomly selected locations may also be allowed.

Scope

This method is intended for use during Quality Control and Quality Assurance sampling and testing during the manufacturing of aggregates, during the production of mixtures, and/or during the placement of materials in their final location on the grade. This method is also intended for post construction use in identifying in-place materials for sampling and testing when production results are called into question.

This method covers determining random samples by tonnage or by geometric stations. The method also covers a methodology for converting a predetermined random tonnage to an equivalent random station when stationing is more advantageous for use by the technician.

Definitions

Lots and Sublots

A lot is a pre-selected quantity representing a sample of the whole or the entire quantity being sampled or measured can be defined as a lot. A lot may be comprised of several portions that are called sublots. Each subplot can then be analyzed to better represent the whole or "lot".

Straight Random Sampling vs. Stratified Random Sampling

Straight random sampling considers an entire lot as a single unit and determines each sample location based on the entire lot size. Stratified random sampling divides the lot into a specified number of sublots or units and then determines each sample location within the distinct subplot or unit. Both methods result in random distribution of samples to be tested for compliance and are normally outlined in the agency's specification.

Procedure

Straight Random Sampling

1. Determine the size of the lot and number of tests required. If statistical means are to be used for acceptance use a minimum of three random tests.
2. Obtain the random numbers to be utilized either by the use of a random number table or other approved method. I.e. Calculator, computer, etc.

Form 1792 R 9-06, is available to assist with the random number management. (A Random Number Table is included in this procedure).

3. Normally, a five digit value is used to determine the random sample location. The entire five digit number can be utilized or portions thereof. Multiply the lot by the random number. This will yield the test location within the lot to perform the testing.

Stratified Random Sampling

1. Determine the number of sublots in the lot by dividing the lot quantity by the defined subplot size and round up to the nearest whole number. If statistical means are to be used for acceptance use a minimum of three sublots. If the lot generates less than three defined sublots, divide the lot quantity by three and redefine the sublots to this new smaller size..
2. Divide the subplot size by the number of tests required. i.e. 5 tests per 1000 ton subplot, equals 1 test per 200 ton subplot segment.
3. Obtain the random numbers to be utilized either by the use of a random number table or other approved method. I.e. Calculator, computer, etc.

Form 1792 R 9-06, is available to assist with the random number management. (A Random Number Table is included in this procedure).

4. Multiply the subplot segment size by the random number and add the beginning tonnage or station to determine the sampling or testing locations. This will yield the test location within the subplot segment to perform the testing.

Converting Predetermined Random Tonnages to Equivalent Random Stations by use of Yield Calculations (In-Place Testing)

1. Designation of a random sample location can be based on either a tonnage or station. Station application is for in-place field work such as density on ACP or sampling of aggregates or soils. Because the required subplot size is typically in a tonnage it is necessary to convert that tonnage into a length per ton to find the corresponding station in the field.

Note: All measurements must be expressed in Feet and % density is in decimal form.

English Example (computing feet per ton):

Given:

- MAMD is 151.9 lbs/ft³
- Density Requirement is 92% (0.92) or the average density determined in the field can be utilized.
- Panel thickness is 2" (2"/12") = (0.167 ft)
- Panel Width 16ft.
- Random Tonnage = 714 tons
- Beginning Station = 183+50

Step 1: Compute the Average Volume per ton.

$$\text{Average Volume} = \frac{2000_{\text{lbs}} / \text{ton}}{151.9_{\text{lbs}} / \text{ft}^3 \times 0.92}$$

$$\text{Average Volume} = \frac{2000_{\text{lbs}} / \text{ton}}{151.9_{\text{lbs}} / \text{ft}^3 \times 0.92} = 14.31_{\text{ft}^3} / \text{ton}$$

Step 2: Calculate the cross-sectional area.

$$\text{Cross - Sectional Area} = 0.167_{\text{ft}} \times 16_{\text{ft}} = 2.67_{\text{ft}^2}$$

Step 3: Calculate the yield in feet per ton of paving by dividing the average volume by the cross-sectional area.

$$\text{Yield} = \frac{14.31_{\text{ft}^3} / \text{ton}}{2.67_{\text{ft}^2}}$$

$$\text{Yield} = \frac{14.31 \cancel{\text{ft}^2} / \text{ton}}{2.67 \cancel{\text{ft}^2}} = 5.36_{\text{ft} / \text{ton}}$$

Step 4: Calculate the number of feet required to pave 714 tons of ACP (714 tons is the random generated value).

$$\text{Feet of Paving} = 714_{\text{tons}} \times 5.36_{\text{ft} / \text{ton}}$$

$$\text{Feet of Paving} = 714_{\cancel{\text{tons}}} \times 5.36_{\text{ft} / \cancel{\text{ton}}} = 3827_{\text{ft}}$$

Step 5: Calculate the random location based on stationing by adding the distance in feet to the reference station.

- First convert the distance to a station reference by dividing the value by 100. $3827 / 100 = 38.27$ or $38+27$.
- Starting reference station is $183+50$.
- $183+50$ plus $38+27 = 221+77$ random location longitudinally.
- Then measure the random distance from desired edge of panel for test site offset.

Note: Taking the inverse or reciprocal of the yield factor, based on a length / weight relationship, a weight to length factor can be determined. Either convention can be utilized to determine a distance of coverage based on a known quantity.

Example:

$$\frac{1}{5.36} = 0.18657_{\text{tons} / \text{ft}}$$

$$\frac{714_{\text{tons}}}{0.18657_{\text{tons} / \text{ft}}} =$$

$$\frac{714_{\cancel{\text{tons}}}}{0.18657_{\cancel{\text{tons}} / \text{ft}}} = 3827_{\text{ft}}$$

Report

All random numbers shall be submitted on standard forms approved by the agency.

Random Number Table

Line/Col.	(1)	(2)	(3)	(4)	(5)	(6)	(7)	(8)	(9)	(10)	(11)
1	16897	16881	22931	30360	86899	51400	15815	41234	81861	82040	35678
2	16066	03723	89146	22426	63867	63506	17781	49403	04287	20424	07348
3	85075	44878	72033	58248	77069	18971	39182	30082	56504	46566	42681
4	92639	30948	57302	81544	63775	52944	80353	63289	86249	75673	09155
5	35721	37005	49818	86207	62735	44649	23672	06383	04114	28132	05908
6	40489	59044	89605	35282	26421	01022	61386	92737	87214	45817	91765
7	44342	01656	85330	48692	24303	00857	37624	26026	24111	11525	09849
8	48339	55094	00436	05613	45626	16491	78652	60998	80789	51080	74835
9	78149	23513	40239	08012	07515	30771	22169	42811	65528	69258	08210
10	53975	05987	19104	37420	24813	05085	57626	68003	81529	15681	28910
11	47291	70452	34590	31785	85351	54591	59692	55567	45079	45751	40201
12	34542	53478	24010	23177	47320	47810	63102	42071	01144	52342	74604
13	07353	34902	98261	40943	21138	20089	18299	39147	87712	40470	72981
14	70361	33031	17937	83411	03889	16309	94376	88326	69494	20471	67255
15	33361	61660	86771	02004	01567	06219	97827	75885	90188	56494	52163
16	12998	73394	24693	34225	42333	69609	53915	18304	82164	56042	12097
17	29623	44833	25355	29022	41902	42322	67751	04941	42039	86077	87066
18	94859	35317	68957	47114	24840	73777	87089	17554	15613	59887	68990
19	68417	40318	85951	46929	07799	11666	94557	69499	73074	78549	50198
20	11826	65897	95213	07860	14082	23312	72457	17117	27707	33332	76374
21	85532	33390	48065	62862	93745	87022	68944	18825	96608	12332	31279
22	09588	86051	27474	46612	94954	66084	28031	11486	26895	56861	49260
23	99396	93908	91658	93214	79134	00272	89581	92129	23926	01510	55723
24	78462	91590	31144	91250	85550	11080	97373	63397	39601	43019	09742
25	98696	01557	06498	39892	02702	52858	36984	45515	21716	92369	81682

ODOT TM 759

Method of Test For

STATIC MODULUS OF ELASTICITY OF POLYMER CONCRETE CYLINDERS

1. Scope*

- 1.1 This test method covers determination of modulus of elasticity (Young's).
- 1.2 The values stated in either SI units or inch-pound units are to be regarded separately as standard. The values stated in each system may not be exact equivalents; therefore, each system shall be used independently of the other. Combining values from the two systems may result in non-conformance with the standard.
- 1.3 *This standard does not purport to address all of the safety concerns, if any, associated with its use. It is the responsibility of the user of this standard to establish appropriate safety and health practices and determine the applicability of regulatory limitations prior to use.*

2. Significance and Use

- 2.1 This test method provides a stress to strain ratio value and a ratio of lateral to longitudinal strain for Premixed Polymer Concrete (PPC) at whatever age and curing conditions may be designated.
- 2.2 The modulus of elasticity values, applicable within the customary working stress range (0 to 40 % of ultimate PPC strength), are used for acceptance of Premixed Polymer Concrete.
- 2.3 The modulus of elasticity values obtained will usually be less than moduli derived under rapid load application (dynamic or seismic rates, for example), and will usually be greater than values under slow load application or extended load duration, given other test conditions being the same.

3. Apparatus

- 3.1 *Testing Machine-* Use a testing machine capable of imposing a load at the rate and of the magnitude prescribed in 6.4. of ASTM C469/C469M. The machine shall conform to the requirements of Practices E4 (Constant-Rate-of-Travel CRT-Type Testing Machines section). The spherical head and bearing blocks shall conform to the Apparatus Section of Test Method C39/C39M.
- 3.2 *Compressometer*³⁻ For determining the modulus of elasticity use a bonded or unbonded sensing device that measures to the nearest 5 millionths the average deformation of two diametrically opposite gauge lines, each parallel to the axis, and each centered about mid-height of the specimen.

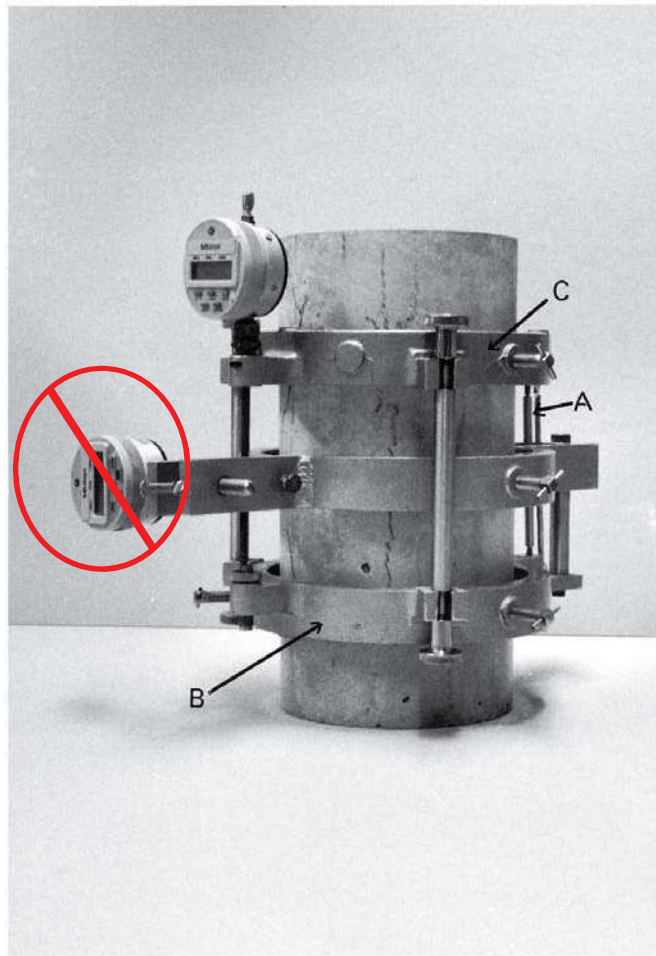

4. Procedure

- 4.1 Use three specimens to determine the modulus of elasticity and compressive strength.
- 4.2 Place the specimen, with the strain-measuring equipment attached, on the lower platen or bearing block of the testing machine. Carefully align the axis of the specimen with the center of thrust of the spherically-seated upper bearing block. Note the reading on the strain indicators. Before applying the load on the specimen, tilt the movable portion of the spherically seated block by hand so that the bearing face appears to be parallel to the top of the test specimen based on visual observation.
- 4.3 Load the specimen two (2) times. Do not record any data during the first loading. Base calculations on the second loading of the specimen.
- 4.4 Apply the load continuously and without shock. Set testing machines of the screw type so that the moving head travels at a rate of about 1 mm/min [0.05 in./min] when the machine is running idle. In hydraulically operated machines, apply the load at a constant rate within the range 250 +/- 50 kPa/s [35 +/- 7 psi/s]. Load the specimen until the applied load is 10,000 lbs.

- 4.5 During the first loading, observe the performance of the gauge. Correct any attachment or alignment defects that may be causing erratic readings prior to the second loading. For the second loading of the sample, apply 100 lb. and zero all gauges and obtain each set of readings as follows: Record, without interruption of loading, the applied load and longitudinal strain every 5,000 lbs. to a minimum 40,000 lbs. If intermediate readings are taken, plot the results of each of the tests with the longitudinal strain as the abscissa and the compressive stress as the ordinate.
- 4.6 Continue loading the sample until the ultimate load is achieved and recorded. Calculate the compressive stress by dividing the ultimate load by the cross-sectional area of the specimen calculated from the diameter.

5. Calculation

- 5.1 Calculate the modulus of elasticity, to the nearest 200 MPa [29,000 psi].

$$E = (S_2 - S_1) / \epsilon_2 - 0.000050)$$

Where:

E = chord modulus of elasticity, MPa [psi],

S_2 = stress corresponding to 40% of ultimate load,

S_1 = stress corresponding to a longitudinal strain, ϵ_1 , of 50 millionths, MPa [psi],
and

ϵ_2 = longitudinal strain produced by stress S_2 .

Take the average of the modulus of elasticity of the three specimens to determine pass/fail results.

ODOT TM 769-19

Method of Test for

Certification of Inertial Profiler Equipment

1. SIGNIFICANCE

- 1.1 This test method describes the procedure for measuring the vertical and horizontal accuracy of an Inertial Profiler for purposes of certification under Oregon Department of Transportation (ODOT) Quality Assurance Program. The profiler will be tested on a calibration course of known International Roughness Index (IRI) for accuracy and repeatability.

2. SCOPE

- 2.1 This test method covers Inertial Profilers employing automated data collection of pavement profile for the purpose of determining IRI. Measurements are made using non-contact sensing systems from a moving platform meeting the requirements of Section 4, equipment and AASHTO M 328.

3. REFERENCED DOCUMENTS

- 3.1 AASHTO M 328
- 3.2 AASHTO R56
- 3.3 AASHTO R 57
- 3.4 ProVAL User Manual

4. EQUIPMENT

- 4.1 An Inertial Profiler, triggering equipment, and calibration equipment meeting the requirements of AASHTO M 328 and AASHTO R 57.
- 4.2 The device must be capable of reporting elevations with a resolution of 0.001 inches or finer at a sampling interval of 2 inches or less within the operating speed of the profiler. The device must provide a means to field calibrate and measure the horizontal distance traveled.
- 4.3 The device must be equipped with software capable of generating, displaying, storing, and reporting IRI at 0.10 mile intervals. The profiler software will be capable of generating a PPF file that contains the data in PPF format.
- 4.4 The Inertial Profiler must be equipped with auto triggering equipment.
- 4.5 Lateral laser spacing of 69 to 71.5 inches is required.
- 4.6 Maintain the low pass filter at 0.000 feet and the High Pass filter at 200.000 feet for all calibration and certification testing.

5. OPERATOR REQUIREMENTS

- 5.1 The operator shall be proficient in the calibration and operation of the profiler per the manufacturers' recommended procedures. The certification of the profiling system is tied to the operator. All prospective operators must go through the certification procedure with the equipment, with acceptable results, to be certified. Certification documentation will show which operators are approved for each profiler.

6. CERTIFICATION REFERENCE SITE

- 6.1 The certification reference site(s) will be designated by the ODOT, Pavement Services Unit. The reference site will include a Distance Measurement Instrument (DMI) verification section and a section for determining the accuracy and the repeatability of the profiler.

7. REFERENCE VALUE DETERMINATION

- 7.1 The profile of the reference site will be determined by the ODOT, Pavement Services Unit using an accepted reference device. The IRI will be computed from the collected data.
- 7.2 The section for DMI Verification will be established by the ODOT, Pavement Services Unit. The start and the end locations of the section will be marked.

8. EQUIPMENT CALIBRATION VERIFICATION

Submit documentation detailing the specifications of the equipment to be used and the manufacturer's recommended calibration and calibration check procedures.

- 8.1 *Distance Measurement Instrument (DMI) Verification:* The DMI of the profiler shall be set to report distance in feet. The operator will guide the profiler over the DMI section length as laid out by ODOT. The DMI must be triggered by the auto triggering equipment at the start and at the end of the DMI section, and the DMI readout recorded. The operator shall make two additional runs following the same procedure. Each run and distance readout will be observed by an ODOT representative. The average of the three absolute differences (between the DMI readout and actual length of section) must be less than 0.10% of the known distance.
- 8.2 If the profiler's DMI does not pass the above requirement, then the operator shall calibrate the DMI to the known distance specified by ODOT, and repeat the three runs as stated above.

Note: The DMI reading is affected by the tire pressure. Hence, operators should make sure that the tire pressure is set to the manufacturers' recommended value and the tires are sufficiently warmed-up before calibrating the profiler and performing the required runs.

- 8.3 *Bounce test:* Perform according to the manufacturer's recommendations. If the profiler manufacturer does not have a procedure, then perform the following:

Position the vehicle on a flat and level surface. Place a smooth, flat, non-glossy material plate under each sensor (the base plate used for the block check can be used). Using the equipment's normal data collection software, initiate a data collection run using a simulated travel speed at the midpoint of the manufacturer's recommended data collection speed range.

(The only difference between a bounce test and a normal data collection run is that there is an artificial longitudinal travel signal supplied and the vehicle is not actually travelling along the road. The bounce test utilizes the same data collection software and routines used during normal data collection).

Allow the profiler to collect a minimum of 528 ft of static profile with the host vehicle as motionless as possible. Next, the sensor(s) should be moved vertically for a total displacement of approximately 1-2 in. (a yardstick may be helpful until the operator gets used to the procedure). This movement must continue until a minimum of 528 ft of simulated longitudinal distance has been covered. The typical method for full size high speed host vehicles is to push the mounting system (bumper) down an inch or so and let the vehicle suspension rebound to create the total vertical travel of 1-2 in. The typical method for light-weight, slow-speed host vehicles is to stand toward the center of the vehicle platform and hop up and down such that all four corners of the vehicle suspension travel approximately 1-2 in. vertically. Stop the test after a minimum of 528 ft of bounce profile is collected.

The IRI during the static portion of the test must be less than 3 in/mile and the IRI during the bounce portion must be less than 10.0 in/mile or the manufacturer's recommended maximum, whichever is less. This requirement shall be met for each sensor. If the IRI value is greater than the stated values, provide documentation explaining why to the ODOT's Pavement Services Unit. The Pavement Services Unit will determine either acceptance or failure of this test based on the documentation provided. An ODOT representative will observe and record the IRI value from the bounce test.

Note: Some profiling systems require a warm-up period before use. The system should be turned on for a minimum of fifteen minutes prior to calibration verification, or per the manufacturer's recommendations.

- 8.4 *Vertical height test:* The height sensor will be checked with blocks of a known thickness of 0.25-in, 0.50-in and 1.00-in. A smooth base plate will be placed under the height sensor height measurements will be taken, or the vertical height will be zeroed. A 0.25-in block will be placed on top of the base plate under the height sensor and height measurements will be taken. The 0.25-in block will be removed and replaced with the 0.50-in block on top of the base plate and height measurements will be taken. The 0.50-in block will be removed and replaced with the 1.00-in block on top of the base plate and height measurements will be taken.

The average height of the base plate will be calculated for those systems that cannot be zeroed. This height will be subtracted from the measured height readings for the 0.25-in block, the 0.50-in block and the 1.00-in block to calculate the measured thickness of each block. The error in calculated thickness will be determined from the average of the absolute values of the difference between the calculated thickness and the known thickness for the measurements. To pass the height test, the average of the absolute differences must be less than or equal to 0.01-in for each block.

An ODOT representative will observe the measured height values of the base plate and blocks.

- 8.5 *Calibration Verification Log:* Maintain a log book which records the inertial profiler's history of all calibrations and equipment repairs or replacement. This log shall be made available to ODOT employees at any time on ODOT projects.

9. EQUIPMENT CERTIFICATION PROCEDURE

- 9.1 *Dynamic Test:* After meeting the requirements of Section 8, the Operator will use the Inertial Profiler to collect profile data on the designated certification reference track. The certification reference track will be a minimum of 528 feet in length.

The Operator will make a minimum series of five runs over the certification reference track. Set the horizontal measurement interval and the reporting interval on the Inertial Profiler to not greater than 2.00 inches. The data collection must be triggered by the automated triggering equipment. Terminate data collection at the end of the designated section. A minimum of five repeat runs of the profiler will be made on each section, and the IRI values computed for each run. The profiler will be operated at the speed that will be used for normal data collection, within the speed range recommended by the manufacturer of the profiler and typical of the data collection speed for contract smoothness measurement.

(Note: Make sure that the tires on the profiler are warmed up before doing the Dynamic test. If they are not warmed up, that can affect the DMI between runs and can significantly affect the Repeatability and Accuracy Scores that are computed in Section 9.3).

- 9.2 *Data Format:* Profile data will be collected, stored, and reported in a format recognized by the latest version of ProVAL (FHWA smoothness software available at www.roadprofile.com), and given to the ODOT representative for evaluation as described in Section 9.3.
- 9.3 *Repeatability and Accuracy:* The latest version of the ProVAL Profiler Certification Module will be used for cross correlation, to evaluate the five runs. For these computations, the following settings will be used in the In ProVAL Profiler Certification Module: (1) basis or comparison filter will be set to IRI without the 250 mm filter applied and (2) the comparison runs filter will be set to IRI with the 250 mm filter applied. A Repeatability score of 90% and an Accuracy score of 88% will be required for both wheel paths for certification.

10. EQUIPMENT REQUIREMENTS

10.1 All of the following conditions must be met for certification of the Inertial Profiler:

- Pass all Equipment Calibration Verifications -- Section 8.
- Meet Repeatability requirement-- Section 9.3.
- Meet Accuracy requirement-- Section 9.3.

11. CERTIFICATION OF OPERATORS AND EQUIPMENT

11.1 The ODOT Pavement Quality & Materials Engineer will make the final determination as to the acceptability of the Equipment for purposes of certification. The certification is good for 365 days, provided there are no software updates, equipment is not damaged or reconfigured and no significant changes are made to the profiling equipment or the host vehicle per the judgment of the Engineer.

Notice of Certification: Upon successful completion of this test method, written notice of certification will be issued by ODOT and include the following:

- Identification of the profiler certified (make, model, serial number, software version, and owner)
- Identification of the operator(s)
- Date of certification
- Low & High Pass filter settings at the time of the certification runs
- Repeatability results
- Verification of IRI using cross correlation results.

ODOT TM 770

Method of Test for

DETERMINING THE GRAPHIC PROFILE INDEX WITH A CALIFORNIA TYPE PROFILOGRAPH OR AN INERTIAL LASER PROFILOMETER

SCOPE

This test method describes the procedure for checking the horizontal and vertical accuracy of the plotter and for determining the profile index from profilograms of pavement made with the California Type Profilograph. A procedure used to locate individual deviations is also included.

Profilograms generated from Profilometers employing an accelerometer established inertial profiling reference and a laser height sensing instrument may also be evaluated using the procedures described herein.

The profilogram is recorded on a horizontal scale of 1:300 and vertical scale of 1:1. The determination of the Profile Index involves measuring “scallop” that appear outside a “blanking” band. The determination of individual high areas involves the use of a special template. An alternative horizontal scale may be used when the calculations are performed by analysis software.

EQUIPMENT

1 California Profilograph

- 1.1 The profilograph shall be the California Type, computerized or not computerized, complete with recorder for determining the profile index of highway pavements.
- 1.2 The equipment consists of a steer able metal frame 25 ft (7.62 m) in length supported at both ends by wheel assemblies consisting of six wheels each.
- 1.3 A rubber tired profile wheel approximately 1.5 ft (0.5 m) in diameter and which may be retracted when not in use is attached at mid-frame. The profile wheel is connected to a mid-frame mounted strip-chart recorder containing rollers for chart paper, recording pen and events marker. The recorder will record the profile of the pavement surface on a horizontal scale of 1:300 and a vertical scale of 1:1. A storage case for the recorder shall be provided.

2 Profilometers

- 2.1** The profilometer shall employ an accelerometer established inertial profiling reference and a laser height sensing instrument to produce a true profile of the pavement surface.
- 2.2** The device must be capable of reporting elevations with a resolution of 0.004 in (0.1 mm) or finer at an interval of 6 in (150 mm) or less. The device must provide a means to calibrate and measure the horizontal distance traveled.
- 2.3** The device must be equipped with software capable of generating the equivalent California Type Profilograph plot (profilogram) and values as well as the locations of bumps and dips.

CALIBRATION TESTS

Perform all calibrations and calibration verifications in the presence of a representative of the Agency. Provide documentation to the Agency that the calibration tests have been successfully completed. The Contractor will submit what equipment will be used, the make model and the Manufacturer's recommended calibration procedure, 10 days before smoothness measurements are to begin.

1 Calibration Frequency

1.1 California Profilograph

The profilograph shall be calibrated at the beginning of each day's use, each time the profilograph is disassembled and reassembled or whenever the accuracy of the profilograph run is in question. Both the vertical and horizontal accuracy of the profilogram shall be checked.

1.2 Profilometer

Perform horizontal and vertical calibration of the profilometer at the frequency recommended by the manufacturer or at any time test results are questionable. It is recommended that the horizontal calibration be checked once per day.

2 Vertical Calibration

2.1 California Profilograph

- 2.1.1** Set the profilograph in a stationary position on a reasonably smooth and level surface.

- 2.1.2 Check the tire pressure of the profile wheel if an inflatable tire is used. It should be 25 psi (172 kPa).
- 2.1.3 Place a 24 in X 36 in X $\frac{1}{8}$ in (600 mm x 900 mm x 3 mm) steel or aluminum plate or $\frac{1}{4}$ in (6 mm) plywood underneath the recording wheel. This will eliminate the unevenness of the surface under the wheel.
- 2.1.4 Mark where the recording pen is located on the vertical scale. For computerized profilographs, follow the manufacturer's instructions.
- 2.1.5 Slide the $\frac{1}{2}$ in (12.5 mm) thick calibration block, as detailed below, underneath the recording wheel in a manner that will result in an accurate motion of the recording pen.
- 2.1.6 Mark the new position of the recording pen and measure the distance between the two marks. For computerized profilographs, follow the manufacturer's instructions.
- 2.1.7 The distance should be $\frac{1}{2}$ in \pm $\frac{1}{16}$ in (12.5 mm \pm 1.5 mm).
- 2.1.8 If the distance is not within these limits, adjust the plotter to the required vertical accuracy prior to use. Follow the manufacturer's recommendation for vertical adjustment.

2.2 Profilometer

Perform vertical calibration of profilometers according to the manufacturer's recommendations.

3 Horizontal Calibration

3.1 California Profilograph

- 3.1.1 Measure and mark off a straight distance of 0.1 mile (200 m) on a reasonably level and smooth paved surface.
- 3.1.2 Place the center of the profile wheel on the zero mark. Mark the location where the recording pen is positioned on the horizontal scale. For computerized profilographs, follow the manufacturer's instructions. Operate the profilograph over the marked distance to the 0.1 mile (200 m) mark. Stop with the center of the profile wheel on the 0.1 mile (200 m) mark.
- 3.1.3 The horizontal graph line should be 21.12 in \pm 0.16 in (667 mm long \pm 4 mm).

- 3.1.4** If the horizontal graph line is not within these limits, adjust the plotter to the required horizontal accuracy prior to use. Follow the manufacturer's recommendation for horizontal adjustment.

Note: Air moisture and tension on the paper roll can affect the horizontal distance.

3.2 Profilometer

- 3.2.1** Measure and mark off a straight distance of 0.1 mile (200 m) on a reasonably level paved surface.

- 3.2.2** Perform horizontal measurement calibration according to the manufacturer's recommendations.

Note the air pressures in the tires on the vehicle when the horizontal calibration is performed. Check the pressures as necessary during the day to ensure the tire pressure is maintained. If the tire pressure changes, adjust the pressure or recalibrate the horizontal measurement. Tire pressure will influence the horizontal distance measured by the profilometer.

4 Calibration Verification

Before performing smoothness measurements on the project, verify the calibration of the California-type profilograph or Laser Profilometer by running the machine twice over a 200 m (0.1 mile) section of pavement with repeating results. The calibration shall be considered acceptable when the difference in Profile Index between consecutive test runs is 5 mm/km (0.3 in/mile) or less. Provide documentation to the Engineer verifying that the calibration and test runs have been successfully completed.

A fog line or other straight line on a relatively smooth pavement surface is suggested for performing this check.

TESTING

- 1** Operate the profiling device to provide complete graphic profiles at all locations required by the contract specification.
- 2** Operate the profiling device either in the direction of vehicle travel or the direction of placement as determined by the Engineer.
- 3** Operate the California Profilograph along the specified wheel paths and other locations at a speed not greater than three miles per hour. Do not tow the profilograph. Operate the Profilometer along the specified wheel paths and other

locations at speeds recommended by the manufacturer. Take care to keep the device as parallel as possible to centerline.

- 4 Mark on the profile chart the appropriate identification and project stationing, matching the project plans, for each profile. For example: northbound, outside travel lane, right wheel path could be identified as N-OL-R. Include project identification and project stations on the outside of the rolls.
- 5 Mark and identify the project stationing on the profiles and identify the location of milepost markers. Initial and date the beginning and ending project stations of each day's run on the profilogram.
- 6 Identify by project stationing on the profiles any areas excluded by specifications.
- 7 The **project** stationing is referenced on the profile chart by marking a line on the chart at a known project station and writing the project station on the chart and, reference the location of milepost markers. The beginning and ending project stations of each day's run is initialed on the profilogram. The project stationing is checked every mile and the chart paper or horizontal location is reset. (If out of tolerance, 1% or 53 feet /mile).

DETERMINATION OF THE PROFILE INDEX

1 General

Before beginning the profile index counts, profiles are divided into 0.1 mile (200 m) segments and into partial segments as required by the contract specifications.

Profilometers and Computerized Profilographs automatically perform the calculations presented below. It will not be necessary to recompute the Profile Index from these devices unless the results are in question.

2 Profile Index Equipment – Manual Trace

The only special equipment needed to determine the profile index is a plastic scale 1.70 in (45 m) wide and 21.12 in (667 mm) long representing a pavement length of 0.1 mile (200 m) at a scale of 1:300. Near the center of the scale is an opaque blanking band 0.2 in (5 mm) wide extending the entire length of the plastic scale. On either side of this blanking band are parallel scribed lines 0.1 in (1 mm) apart. These lines serve as a convenient scale to measure deviations called “scallop” of the profile above and below the blanking band.

3 Method of Counting for Profile Index

- 3.1 Place the plastic scale over the profile in such a way as to “blank out” as much of the profile as possible. When this is done, scallops above and below the blanking band will be approximately balanced.
- 3.2 For short radius super elevated curves it is necessary to shift the scale to blank out the central portion of the trace. When such conditions occur, the profile is broken into short sections and the blanking band repositioned on each section while counting.
- 3.3 Beginning at the right end of the scale, measure and total the height of all the scallops appearing both above and below the blanking band, measuring each scallop to the nearest 1 mm (0.05 in). Write this total on the profile sheet near the left end of the scale together with a small mark to align the scale when moving to the next section. Short portions of the profile line may be visible outside the blanking band, but unless they project 0.05 in (1 mm) or more and extend longitudinally for 2 ft (0.6 m) (0.1 in (2 mm) on the profilogram) or more, they are not included in the count.
- 3.4 When scallops occurring in the first 0.1 mile (200 m) section are totaled, slide the scale to the left, aligning the right end of the scale with the small mark previously made and proceed with the counting in the same manner.

4 Calculation of the Profile Index

The profile index is the inches per mile in excess of the 0.2 in (5 mm) blanking band. The formulas for converting counts to profile index is as follows:

METRIC

$$\text{Profile Index} = \frac{\text{Total Count (mm)} \times 1000 \text{ m/km}}{\text{Length (m) of Full 200 m Segment or of Partial } _____ * \text{ m Segment}}$$

* Report to nearest whole meter

ENGLISH

$$\text{Profile Index} = \frac{\text{Total Count (in)}}{\text{Length of Full 0.1 mile Segment or of Partial } _____ * \text{ mile Segment}}$$

* Report to nearest 0.01 mile

DETERMINATION OF INDIVIDUAL DEVIATIONS IN EXCESS OF 0.36 in (9 mm)

Profilometers and Computerized Profilographs automatically perform the calculations presented below. It will not be necessary to re-compute the individual deviations from these devices unless the results are in question.

1 Equipment – Manual Trace

The only special equipment needed is a plastic template having a line 1 in (25 mm) long scribed on one face with a small hole or scribed mark at either end and a slot 0.36 in (9 mm) from and parallel to the scribed line. (1 in (25 mm) line corresponds to a horizontal distance of 25 ft (7.5 m) on the horizontal scale of the profilogram.)

2 Procedure

- 2.1** At each prominent peak or high point on the profile trace, place the template so that the small holes or scribe marks at each end of the scribed line intersect the profile trace to form a chord across the base of the peak or indicated bump. The line on the template does not need to be horizontal. With a sharp pencil draw a line using the narrow slot in the template as a guide. Any portion of the trace extending above this line will indicate the approximate length and height of the deviation in excess of 0.36 in (9 mm).
- 2.2** There may be instances where the distance between easily recognizable low points is less than (1 in (25 ft)) (25 mm (7.5 m)). In such cases a shorter chord length shall be used in making the scribed line on the template tangent to the trace at the low points. It is the intent, however, that the baseline for measuring the height of bumps will be as nearly 25 ft (1 in) (7.5 m (25 mm)) as possible, but in no case to exceed this value. When the distance between prominent low points is greater than 25 ft (1 in) (7.5 m (25 mm)), make the ends of the scribed line intersect the profile trace when the template is in a nearly horizontal position.

ODOT TM 772-19

Method of Test for

DETERMINING THE INTERNATIONAL ROUGHNESS INDEX WITH AN INERTIAL LASER PROFILER

1. SCOPE

- 1.1 This test method describes the procedure for operating a profiler, checking the calibration (horizontal and vertical accuracy) of the profiler, and determining the International Roughness Index (IRI) and areas of Localized Roughness from pavement profiles obtained by an inertial profiler. A procedure for Quality Control and Quality Assurance smoothness measurements on paving projects is also included.

2. REFERENCED DOCUMENTS

- 2.1 AASHTO M 328
- 2.2 AASHTO R 54
- 2.3 AASHTO R 56
- 2.4 AASHTO R 57
- 2.5 ProVAL User Manual

3. EQUIPMENT

3.1 Profilers

- 3.1.1 The profilers shall employ an accelerometer established inertial profiling reference and a laser height sensing instrument to produce a true profile of the pavement surface, as described in AASHTO M 328.
- 3.1.2 The device must be capable of reporting elevations with a resolution of 0.001 inches or finer at a sampling interval of 2 inches or less within the operating speed of the profiler. The device must provide a means to field calibrate and measure the horizontal distance traveled.
- 3.1.3 The device must be equipped with software capable of generating, displaying, storing, and reporting IRI at 0.10 mile intervals. The profiler software is required to generate .PPF files that contain the data in .PPF format
- 3.1.4 Maintain the low pass filter setting at 0.00 feet.
- 3.1.5 Maintain the high pass filter setting at 200.00 feet

4. CALIBRATION VERIFICATION

Submit to the Project Manager for approval at least 10 days before smoothness measurements are to begin, the following:

- Documentation detailing equipment to be used and the manufacturer's recommended calibration and calibration check procedures;
- The ODOT Pavement Services Unit Certification documentation, showing certification of the operator and profiling equipment.

Perform all calibration verifications in the presence of the designated representative of the Project Manager.

4.1 Calibration Frequency

At a minimum, perform calibration once per calendar year per the manufacturer's recommendations and procedures.

4.2 Profiler Calibration Check

Perform horizontal and vertical calibration check at the frequency recommended by the manufacturer or at any time during testing if the test results are questionable. At a minimum, check vertical and horizontal calibration daily and at any time a configuration change is made to the profiler.

4.2.1 Vertical Calibration Check

Perform a vertical calibration check on each height sensor in the profiler according to the manufacturer's recommendations. At a minimum, (1) obtain a reading on a smooth base plate, then place a 0.25-in thick block on the base plate, and obtain a reading, and from these two readings compute the thickness of the block as measured by the profiling system, (2) obtain a reading on a smooth base plate, then place a 0.50-in thick block on the base plate and obtain a reading, and from these two readings compute the thickness of the block as measured by the profiling system, (3) obtain a reading on a smooth base plate, then place a 1.00-in thick block on the base plate and obtain a reading, and from these two readings compute the thickness of the block as measured by the profiling system. The thickness of the blocks used for this test shall meet the requirements of AASHTO R 57. The thickness of the blocks as determined by the profiling system should be within 0.01 inches of the actual thickness of the block.

4.2.2 Horizontal Calibration Check

This check is performed to verify the accuracy of the Distance Measurement Instrument (DMI). As a minimum, measure and mark off (to within 0.05%) a straight distance of 528 feet on a reasonably level, paved surface. Test the section 3 times.

The average of the three runs should be less than 1 foot absolute difference from the known 528 feet. If the profiler fails to meet this requirement, calibrate the DMI according to the manufacturer's recommendations and repeat the horizontal calibration and adjustments until the required average is achieved.

Note: Check the air pressure in the tires on the vehicle as necessary during horizontal calibration process to ensure the tire pressure is maintained. If the tire pressure changes, adjust the pressure or recalibrate the horizontal measurement until acceptable, repeatable horizontal calibration check is accomplished. Tire pressure will influence the horizontal distance measured by the profiler.

4.3 Bounce Test

Perform the Bounce test according to the manufacturer's recommendations. As a minimum, place the profiler on a flat level smooth pavement with the electronics on and the vehicle stationary. The IRI corresponding to each sensor should be less than 3.0 inches/mile, for the time period that it would take the profiler to travel 528 feet. Next, move the vehicle ("bounce") vertically with 2 inches minimum of vertical travel, for the time period that it would take the profiler to travel 0.10 mile. The IRI corresponding to each sensor should be under 10.0 inch/mile or under the manufacturer's recommended maximum, whichever is less.

4.4 Calibration Verification

Before performing smoothness measurements on the project for each shift (day or night) of testing, verify the calibration of the Profiler by operating the machine twice over a 528 foot section of pavement with repeating test results. The calibration shall be considered acceptable when the difference in IRI between 2 consecutive test runs is 4.0 in/mile or less. If a single laser is used, then one wheel path will be tested. If two lasers are used (right and left) the average of the two IRI will be used. Provide documentation to the Project Manager verifying that the calibration and test runs have been successfully completed for each shift of testing.

A fog line or other straight line on a relatively smooth pavement surface is suggested for performing this check.

Maintain a log to be kept with the profiler, to provide a record of calibration history.

5. QUALITY CONTROL PROFILE TESTING AND REPORTING

- 5.1 Operate the profiling device to provide data for complete graphic profiles at all locations required by the contract specification.
- 5.2 Locate and mark all excluded areas by specification. Use white paint or other approved marking material on the shoulder adjacent to each lane to show where each auto trigger was placed. **Do not evaluate, for IRI, excluded areas noted in the specifications. These areas are to be left out of the IRI analysis.** Test excluded areas according to the applicable specification.

For auxiliary and slow lanes in passing sections, start the profile of the slow lane at the end of the taper where the lane becomes full width, and terminate the profile at the start of the taper from the full lane width (usually first skip stripe to last skip stripe). On bridges with skews, locate the start and end of the bridge exclusion where the 50 feet is the minimum distance from any point in the profiled lane from the bridge joint or end panel, as applicable (i.e. 50 feet from where the lane line first contacts the skew of the bridge when traveling towards the bridge).

- 5.3 Operate the profiling device in the direction of travel.
- 5.4 Set the reporting interval to 2.0 inches or less.
- 5.5 Operate the profiler in order to collect data along the specified wheel paths at a constant speed, which is within the operating speed range as recommended by the manufacturer (see Section 5.9 for the location of the wheel paths). Take care to keep the device as parallel as possible to centerline. Bring the profiler to the desired speed and alignment prior to the beginning of the test section. Maintain the profiler speed at as constant a rate as possible throughout the test section. Use the manufacturer's recommended lead-in and lead-out distances, or a minimum of 200 feet. Profiler speed will be maintained through the end of the test section.
- 5.6 Label Profile reports and data files with the appropriate identification and project stationing, matching the project plans, for each profile. For example: northbound, fast lane could be identified as NB-A-Lane. Include project identification and project stations on the report that contains the table outlined in section 5.11.
- 5.7 Mark and identify the project stationing on the profiles. Initial and date the beginning and ending project stations of each day's test runs on the profile reports.
- 5.8 A horizontal distance tolerance of a maximum of 1.0% or 53 feet/mile is required. Reference the project stationing on the profile at a known project station at the beginning and ending of each run and excluded area. Write the project station on the chart or use event markers to reference the locations of verified project stationing. Check the project stationing every mile at a minimum.
- 5.9 Measure both the right and left wheel path. Measure the left wheel path at 3 feet from the lane divider (center line). Measure the right wheel path at 9 feet from the lane divider (center line). When using an inertial profiler that collects a single wheel path per pass, make sure that each wheel path starts and stops at the same longitudinal location.
- 5.10 Do not mix travel lanes in the same data file. Submit profile data (hard copies and data files – in .PPF and manufacturer specific file formats) for all travel lanes and wheel paths for the entire project except for excluded areas, per specification (do not profile excluded areas).
- 5.11 Submit to the Project Manager a table that identifies the lanes, wheel paths, and distance locations (Stations and/or Mile Posts) tested for each data file, representing all profiles on the project. (Most profile manufacturers have a reporting format that is acceptable.)

- 5.12 The Project Manager will evaluate the profile reports generated from manufacturer specific or .PPF raw data files through the most current version of the ProVAL software (available at www.roadprofile.com) for payment according to 00745.96. IRI values are evaluated to the nearest 0.1 inches/mile.

6. DETERMINATION OF THE INTERNATIONAL ROUGHNESS INDEX

Using ProVAL, or equivalent profiler manufacturer software, calculate the left wheel path IRI, right wheel path IRI, and the mean IRI (average of left and right wheel path IRI) for each 0.10 mile and partial section. The mean IRI will be used for incentive/disincentive determination according to 00745.96.

7. DETERMINATION OF LOCALIZED ROUGHNESS

Use the most current version of ProVAL, or equivalent profiler manufacturer software, to evaluate profiles for areas of Localized Roughness per the Specification minimum. Determine areas of localized roughness by computing the IRI over a continuous 25-ft length. Determine areas of localized roughness for each wheel path. Generate a report and submit it to the Project Manager for review. Stake or mark areas identified as exceeding the minimum specified Localized Roughness in a method acceptable to the Engineer for the ride test per specification.

8. QUALITY ASSURANCE

At the discretion of the Project Manager, the Agency will perform Quality Assurance of profiles on the projects according to the following:

The Agency profiler or a third party profiler may run a verification of completed wearing course areas under the IRI specification for the contract or season of paving. The Contractor run profile will be considered acceptable if the mean IRI of both wheel paths averaged over all profiled lanes has a minimum of 90.0% of all measured 0.1 mile segments deviate by less than ± 6.0 in/mile IRI. The Project Manager will resolve any discrepancies; this could include re-certification of the profilers, or third party testing of smoothness on the project.

ODOT TM 775

Method of Test for

NON-DESTRUCTIVE DEPTH MEASUREMENT OF PORTLAND CEMENT CONCRETE PAVEMENT

SCOPE

This method uses a probe and ring device to measure the thickness of freshly placed portland cement concrete pavement.

APPARATUS

1. Probe – A 6 mm (1/4 in) rod graduated in 2 mm (0.1 in) increments capable of measuring depths from 200 mm (8 in) to 350 mm (14 in).
2. Ring Device - A 150 mm (6 in) diameter sliding ring that is capable of being locked to the probe.

PROCEDURE

1. Determine random sample locations according to current Agency procedures
2. While holding onto the ring device, insert the probe into the freshly placed concrete pavement. Adjust the rod slightly as necessary to ensure that the probe makes contact with the underlying base material.
3. Slowly release the ring device until it comes to rest against the pavement surface. The ring must be uniformly seated for its entire circumference on the surface or the probe is not perpendicular to the surface.
4. Lock the ring device to the probe in this position.
5. Remove the apparatus and read the depth at the top of the ring device.
6. Document results according to Agency procedures.

REPORTING

Results shall be reported on standard forms approved for use by the agency. Provide the following information:

- Date and Time
- Project information
- Location (stationing) of thickness determination (longitudinal and offset reference)
- Note random method used
- Thickness of measurement to nearest 1mm (0.1inch)
- Signature of individual performing measurement

ODOT TM 777

Method of Test for

EVALUATION OF RETROREFLECTIVITY OF DURABLE & HIGH PERFORMANCE PAVEMENT MARKINGS USING PORTABLE HAND-OPERATED INSTRUMENT

1. SCOPE

1.1 This method covers the testing of retroreflectivity of durable and high performance pavement markings using portable hand-operated instruments. It is intended to provide a standard method for evaluating as-constructed retroreflectivity of longitudinal and transverse pavement markings in a contract to assure minimum retroreflectivity standards are met as per standard specifications.

1.2 For the purpose of this test procedure, the term “retroreflectivity” refers to dry retroreflectivity.

2. REFERENCED DOCUMENTS

2.1 ASTM E 1710-05, “Standard Test Method for Measurement of Retroreflective Pavement Marking Materials with CEN-Prescribed Geometry Using a Portable Retroreflectometer.”

3. DEFINITIONS

Lot: The portion of a street or highway where new pavement markings are installed. If a street or highway includes two or more separate roadways (e.g. divided highway), lot may refer to each roadway separately.

Sublot: Each lot is divided into a number of sublots based on the total length of the lot.

4. APPARATUS

4.1 Use a 30-meter geometry hand-operated retroreflectometer meeting ASTM E 1710-05 with the following capabilities:

- Built-in printer
- Date and Time stamp
- ID labeling

5. CALIBRATION OF APPARATUS

5.1 Calibrate and service the apparatus by the manufacturer every two years per manufacturer's recommendation. Carry the certification of calibration at all times.

5.2 Zero and calibrate the apparatus in the field per the manufacturer's instructions. Perform calibrations at the beginning of each day of use and as frequently as recommended by the manufacturer.

6. PROCEDURE

6.1 Measure retroreflectivity of durable and high performance pavement markings within 48 hours of application of markings.

6.2 When taking Measurements:

- If a valid measurement is not attainable at a location due to a pothole, grass, obvious tracking, a profiled bump, etc., move forward to the first available location for a valid reading.
- Take measurements on a dry and clean surface. Ambient temperature shall be more than 40 degrees Fahrenheit. Do not take measurements if there is fog or surface condensation.

6.3 For yellow lines and crosswalk bars, take measurements in alternate directions. For all other markings, take measurements in the direction of traffic.

6.4 If a project contains multiple material types (e.g.: thermoplastic edge lines and tape broken lines), evaluate each material type separately for acceptance.

7. SAMPLING FREQUENCY

7.1 General:

If a lot length is one mile or less, the entire lot is a subplot.

For lots longer than one mile, divide the lot into sublots, where each subplot is one mile long. If the last subplot is less than 1/2 mile long, combine this subplot with the previous subplot. If the length of the last subplot is 1/2 mile or more, treat this subplot as a separate subplot.

7.2 Measurement of Retroreflectivity

7.2.1 Longitudinal Markings:

- For sublots that are one mile long or longer, take measurements at 300 ft intervals for each line.
- For sublots that are less than one mile long, take measurements at 300 ft intervals for each line. If the total number of readings for a color is less than 10, take at least 10 readings at equal intervals for that color.

7.2.2 Transverse Markings:

- The Engineer will randomly select 25 percent of the bars within each subplot for retroreflectivity testing. Round fractions up to the next whole number.
 - Each stop bar and crosswalk bar is a separate marking.
 - Measurement will be based on the area of each selected bar. Take one random measurement in every three sq. ft. of each selected bar.
- The Engineer will randomly select 25 percent of the legends from each subplot for retroreflectivity testing. Round fractions up to the next whole number.
 - Each legend is a separate marking. For legends with more than one element (i.e. bicycle and railroad crossing), each element counts as a separate legend for testing purposes.
 - For legends that are eight ft or more in height or width, take five random measurements per legend.
 - For legends that are less than eight ft in height or width, take three random measurements per legend.

8. REPORTING

8.1 Record all data on ODOT forms 734-4101 thru 734-4105 as required.

8.2 Attach field print-outs from the retroreflectometer for each zero and calibration reading performed.

8.3 Attach field print-outs from the retroreflectometer with the following information contained on the print-out for each measurement:

- Date and time
- Location ID

INSERT TAB

AASHTO

Bulk Density (“Unit Weight”) and Voids in Aggregate

AASHTO Designation: T 19/T 19-19

ASTM Designation: C29/C 29M-07

AASHTO TEST METHODS CANNOT BE INCLUDED ON ODOT’S WEBSITE DUE TO COPYRIGHT INFRINGEMENT.

TO GET COPIES OF THE TEST METHODS, YOU CAN ORDER A HARD COPY OF ODOT’S **MANUAL OF FIELD TEST PROCEDURES** OR YOU CAN ORDER THE LATEST **STANDARD SPECIFICATIONS FOR TRANSPORTATION MATERIALS AND METHODS OF SAMPLING AND TESTING** FROM AASHTO.

To order ODOT’s *Manual of Field Test Procedures*, use the following web address:

<https://www.oregon.gov/ODOT/Forms/2ODOT/7345110.pdf>

To order AASHTO’s *Standard Specifications for Transportation Materials and Methods of Sampling and Testing*, visit the [AASHTO Store website](#).



Oregon

Kate Brown, Governor

Department of Transportation

Construction Section
800 Airport Road SE
Salem, OR 97301-4792
Phone: (503) 986-3000
Fax: (503) 986-3096

November 30, 2017

To: All Holders of the Manual of Field Test Procedures

Section: **Test Procedure AASHTO T 22**

The Oregon Department of Transportation has specified method(s) for this Test Procedure. Please observe the following for our projects:

- The use of unbonded caps as defined by ASTM C1231/C1231M-15, for compressive strength determination, is an allowable option.

Compressive Strength of Cylindrical Concrete Specimens

AASHTO Designation: T 22-20

ASTM Designation: C39/C 39M-05

AASHTO TEST METHODS CANNOT BE INCLUDED ON ODOT'S WEBSITE DUE TO COPYRIGHT INFRINGEMENT.

TO GET COPIES OF THE TEST METHODS, YOU MAY ORDER A HARD COPY OF ODOT'S **MANUAL OF FIELD TEST PROCEDURES** OR YOU MAY ORDER THE LATEST **STANDARD SPECIFICATIONS FOR TRANSPORTATION MATERIALS AND METHODS OF SAMPLING AND TESTING** FROM AASHTO.

To order ODOT's *Manual of Field Test Procedures*, use the following web address:

<https://www.oregon.gov/ODOT/Forms/2ODOT/7345110.pdf>

To order AASHTO's *Standard Specifications for Transportation Materials and Methods of Sampling and Testing*, visit the [AASHTO Store website](#).



Oregon

Theodore R. Kulongoski, Governor

Oregon Department of Transportation

Construction Section
800 Airport Road SE
Salem, OR 97301-4798
Telephone (503) 986-3000
FAX (503) 986-3096

October 31, 2010

To: All Holders of the Manual of Field Test Procedures

Section: **Test Procedure AASHTO T 23**

The Oregon Department of Transportation has specified method(s) for this Test Procedure. Please observe the following for our projects:

- **Under Procedure - Initial Curing, Use Method 1, cure in a cooler with controlled water temperature. See test procedure for temperature requirements.**
- **Use a high/low temperature-recording device to monitor temperature during curing process. Record the high/low temperature range during the cure process on agency approved form.**
- **Under Procedure - Transporting Specimens, Delete Bullet 4 and replace with the following:**
 - **For concrete cylinders that are not able to be placed in final cure at the site where the compression testing will be performed, within 48 hours, a “temporary final cure” environment will be provided and maintained. Cylinders placed into this “temporary final cure” environment will then be transported to the final cure location within 12 days of casting. Temporary final cure is defined as;**
 - **Temporary final cure –An environment that meets the temperature and moisture requirements of bullet 2 under “Final Curing” of AASHTO T23. Curing may be accomplished in a moist room or water tank conforming to AASHTO M201. Molds do not have to be removed for Cylinders in Temporary final cure**
- **Under Procedure for Making Cylinders—Rodding step 3, the use of a mallet meeting the requirements under apparatus may be used for single-use plastic molds conforming to AASHTO M-205.**

METHOD OF MAKING AND CURING CONCRETE TEST SPECIMENS IN THE FIELD FOP FOR AASHTO T 23

Scope

This procedure covers the method for making, initially curing, and transporting concrete test specimens in the field in accordance with AASHTO T 23-18.

Warning—Fresh Hydraulic cementitious mixtures are caustic and may cause chemical burns to skin and tissue upon prolonged exposure.

Apparatus

- Concrete cylinder molds: Conforming to AASHTO M 205 with a length equal to twice the diameter. Standard specimens shall be 150 mm (6 in.) by 300 mm (12 in.) cylinders. Mold diameter must be at least three times the maximum aggregate size unless wet sieving is conducted according to the FOP for WAQTC TM 2. Agency specifications may allow cylinder molds of 100 mm (4 in.) by 200 mm (8 in.) when the nominal maximum aggregate size does not exceed 25 mm (1 in.).
- Beam molds: Rectangular in shape with ends and sides at right angles to each other. Must be sufficiently rigid to resist warpage. Surfaces must be smooth. Molds shall produce length no more than 1.6 mm (1/16 in.) shorter than that required (greater length is allowed). Maximum variation from nominal cross section shall not exceed 3.2 mm (1/8 in.). Ratio of width to depth may not exceed 1:5; the smaller dimension must be at least 3 times the maximum aggregate size. Standard beam molds shall result in specimens having width and depth of not less than 150 mm (6 in.). Agency specifications may allow beam molds of 100 mm (4 in.) by 100 mm (4 in.) when the nominal maximum aggregate size does not exceed 38 mm (1.5 in.). Specimens shall be cast and hardened with the long axes horizontal.
- Standard tamping rod: 16 mm (5/8 in.) in diameter and 400 mm (16 in.) to 600 mm (24 in.) long, having a hemispherical tip of the same diameter as the rod for preparing 150 mm (6 in.) x 300 mm (12 in.) cylinders.
- Small tamping rod: 10 mm (3/8 in.) diameter and 305 mm (12 in.) to 600 mm (24 in.) long, having a hemispherical tip of the same diameter as the rod for preparing 100 mm (4 in.) x 200 mm (8 in.) cylinders.
- Vibrator: At least 9000 vibrations per minute, with a diameter no more than 1/4 the diameter or width of the mold and at least 75 mm (3 in.) longer than the section being vibrated for use with low slump concrete.
- Scoop: a receptacle of appropriate size so that each representative increment of the concrete sample can be placed in the container without spillage.
- Trowel or float

- Mallet: With a rubber or rawhide head having a mass of 0.57 ± 0.23 kg (1.25 ± 0.5 lb.).
- Rigid base plates and cover plates: may be metal, glass, or plywood.
- Initial curing facilities: Temperature-controlled curing box or enclosure capable of maintaining the required range of 16 to 27°C (60 to 80°F) during the entire initial curing period (for concrete with compressive strength of 40 Mpa (6000 psi) or more, the temperature shall be 20 to 26°C (68 to 78°F). As an alternative, sand or earth for initial cylinder protection may be used provided that the required temperature range is maintained, and the specimens are not damaged.
- Thermometer: Capable of registering both maximum and minimum temperatures during the initial cure.

Procedure – Making Specimens – General

1. Obtain the sample according to the FOP for WAQTC TM 2.
2. Wet Sieving per the FOP for WAQTC TM 2 is required for 150 mm (6 in.) diameter specimens containing aggregate with a nominal maximum size greater than 50 mm (2 in.); screen the sample over the 50 mm (2 in.) sieve.
3. Remix the sample after transporting to testing location.
4. Begin making specimens within 15 minutes of obtaining the sample.
5. Set molds upright on a level, rigid base in a location free from vibration and relatively close to where they will be stored.
6. Fill molds in the required number of layers, attempting to slightly overfill the mold on the final layer. Add or remove concrete before completion of consolidation to avoid a deficiency or excess of concrete.
7. There are two methods of consolidating the concrete – rodding and internal vibration. If the slump is greater than 25 mm (1 in.), consolidation may be by rodding or vibration. When the slump is 25 mm (1 in.) or less, consolidate the sample by internal vibration. Agency specifications may dictate when rodding or vibration will be used.

Procedure – Making Cylinders –Self-Consolidating Concrete

1. Use the scoop to slightly overfill the mold. Evenly distribute the concrete in a circular motion around the inner perimeter of the mold.
2. Strike off the surface of the molds with tamping rod, straightedge, float, or trowel.
3. Immediately begin initial curing.

Procedure – Making Cylinders – Rodding

1. For the standard 150 mm (6 in.) by 300 mm (12 in.) specimen, fill each mold in three approximately equal layers, moving the scoop or trowel around the perimeter of the mold to evenly distribute the concrete. For the 100 mm (4 in.) by 200 mm (8 in.) specimen, fill the mold in two layers. When filling the final layer, slightly overfill the mold.
2. Consolidate each layer with 25 strokes of the appropriate tamping rod, using the rounded end. Distribute strokes evenly over the cross section of the concrete. Rod the first layer throughout its depth without forcibly hitting the bottom. For subsequent layers, rod the layer throughout its depth penetrating approximately 25 mm (1 in.) into the underlying layer.
3. After rodding each layer, tap the sides of each mold 10 to 15 times with the mallet (reusable steel molds) or lightly with the open hand (single-use light-gauge molds).
4. Strike off the surface of the molds with tamping rod, straightedge, float, or trowel.
5. Immediately begin initial curing.

Procedure – Making Cylinders – Internal Vibration

1. Fill the mold in two layers.
2. Insert the vibrator at the required number of different points for each layer (two points for 150 mm (6 in.) diameter cylinders; one point for 100 mm (4 in.) diameter cylinders). When vibrating the bottom layer, do not let the vibrator touch the bottom or sides of the mold. When vibrating the top layer, the vibrator shall penetrate into the underlying layer approximately 25 mm (1 in.)
3. Remove the vibrator slowly, so that no large air pockets are left in the material.

Note 1: Continue vibration only long enough to achieve proper consolidation of the concrete. Over vibration may cause segregation and loss of appreciable quantities of intentionally entrained air.

4. After vibrating each layer, tap the sides of each mold 10 to 15 times with the mallet (reusable steel molds) or lightly with the open hand (single-use light-gauge molds).
5. Strike off the surface of the molds with tamping rod, straightedge, float, or trowel.
6. Immediately begin initial curing.

Procedure – Making Flexural Beams – Rodding

1. Fill the mold in two approximately equal layers with the second layer slightly overfilling the mold.
2. Consolidate each layer with the tamping rod once for every 1300 mm² (2 in²) using the rounded end. Rod each layer throughout its depth, taking care to not forcibly strike the bottom of the mold when compacting the first layer. Rod the second layer throughout its depth, penetrating approximately 25 mm (1 in.) into the lower layer.

3. After rodding each layer, strike the mold 10 to 15 times with the mallet and spade along the sides and end using a trowel.
4. Strike off the surface of the molds with tamping rod, straightedge, float, or trowel.
5. Immediately begin initial curing.

Procedure – Making Flexural Beams – Vibration

1. Fill the mold to overflowing in one layer.
2. Consolidate the concrete by inserting the vibrator vertically along the centerline at intervals not exceeding 150 mm (6 in.). Take care to not over-vibrate and withdraw the vibrator slowly to avoid large voids. Do not contact the bottom or sides of the mold with the vibrator.
3. After vibrating, strike the mold 10 to 15 times with the mallet.
4. Strike off the surface of the molds with tamping rod, straightedge, float, or trowel.
5. Immediately begin initial curing.

Procedure – Initial Curing

- When moving cylinder specimens made with single use molds support the bottom of the mold with trowel, hand, or other device.
- For initial curing of cylinders, there are two methods, use of which depends on the agency. In both methods, the curing place must be firm, within ¼ in. of a level surface, and free from vibrations or other disturbances.
- Maintain initial curing temperature:
 - 16 to 27°C (60 to 80°F) for concrete with design strength up to 40 Mpa (6000 psi).
 - 20 to 26°C (68 to 78°F) for concrete with design strength of 40 Mpa (6000 psi) or more.
- Prevent loss of moisture.

Method 1 – Initial cure in a temperature-controlled chest-type curing box

1. Finish the cylinder using the tamping rod, straightedge, float, or trowel. The finished surface shall be flat with no projections or depressions greater than 3.2 mm (1/8 in.).
2. Place the mold in the curing box. When lifting light-gauge molds be careful to avoid distortion (support the bottom, avoid squeezing the sides).
3. Place the lid on the mold to prevent moisture loss.
4. Mark the necessary identification data on the cylinder mold and lid.

Method 2 – Initial cure by burying in earth or by using a curing box over the cylinder

Note 2: This procedure may not be the preferred method of initial curing due to problems in maintaining the required range of temperature.

1. Move the cylinder with excess concrete to the initial curing location.
2. Mark the necessary identification data on the cylinder mold and lid.
3. Place the cylinder on level sand or earth, or on a board, and pile sand or earth around the cylinder to within 50 mm (2 in.) of the top.
4. Finish the cylinder using the tamping rod, straightedge, float, or trowel. Use a sawing motion across the top of the mold. The finished surface shall be flat with no projections or depressions greater than 3.2 mm (1/8 in.).
5. If required by the agency, place a cover plate on top of the cylinder and leave it in place for the duration of the curing period, or place the lid on the mold to prevent moisture loss.

Procedure – Transporting Specimens

- Initially cure the specimens for 24 to 48 hours. Transport specimens to the laboratory for final cure. Specimen identity will be noted along with the date and time the specimen was made and the maximum and minimum temperatures registered during the initial cure.
- Protect specimens from jarring, extreme changes in temperature, freezing, or moisture loss during transport.
- Secure cylinders so that the axis is vertical.
- Do not exceed 4 hours transportation time.

Final Curing

- Upon receiving cylinders at the laboratory, remove the cylinder from the mold and apply the appropriate identification.
- For all specimens (cylinders or beams), final curing must be started within 30 minutes of mold removal. Temperature shall be maintained at $23^{\circ} \pm 2^{\circ}\text{C}$ ($73 \pm 3^{\circ}\text{F}$). Free moisture must be present on the surfaces of the specimens during the entire curing period. Curing may be accomplished in a moist room or water tank conforming to AASHTO M 201.
- For cylinders, during the final 3 hours before testing the temperature requirement may be waived, but free moisture must be maintained on specimen surfaces at all times until tested.
- Final curing of beams must include immersion in lime-saturated water for at least 20 hours before testing.

Report

- On forms approved by the agency
- Pertinent placement information for identification of project, element(s) represented, etc.
- Sample ID
- Date and time molded.
- Test ages.
- Slump, air content, and density.
- Temperature (concrete, initial cure max. and min., and ambient).
- Method of initial curing.
- Other information as required by agency, such as: concrete supplier, truck number, invoice number, water added, etc.



Oregon

Theodore R. Kulongoski, Governor

Oregon Department of Transportation

Construction Section

800 Airport Road SE

Salem, OR 97301-4798

Telephone (503) 986-3000

FAX (503) 986-3096

DATE: October 31, 2007

TO: All Holders of the Manual of Field Test Procedures

File Code:

SECTION: **Test Procedure AASHTO T 27/11**

The Oregon Department of Transportation has specified method(s) for this Test Procedure. Please observe the following for our projects:

- Under procedure Method A, step 1, the initial dry mass of the sample may be determined utilizing a companion moisture sample (this is an option not a requirement).
- Perform the moisture test according to T 255/ T 265.
- Shaking time for all methods will be a minimum of 10 minutes.
- Use the following formula to adjust the wet mass of the sample to the initial dry mass:

$$\text{Initial Dry Mass} = \left\{ \frac{WM}{1 + \left(\frac{\% M}{100} \right)} \right\}$$

Where: WM = Initial Wet Mass of T 27/11 sample.

%M = Moisture content of companion moisture sample.

- Document the Initial Wet Mass of the sample when utilizing a companion moisture.

**SIEVE ANALYSIS OF FINE AND COARSE AGGREGATES
FOP FOR AASHTO T 27
MATERIALS FINER THAN 75 μM (NO. 200) SIEVE IN MINERAL AGGREGATE
BY WASHING
FOP FOR AASHTO T 11**

Scope

A sieve analysis, or ‘gradation,’ measures distribution of aggregate particle sizes within a given sample.

Accurate determination of the amount of material smaller than 75 μm (No. 200) cannot be made using just AASHTO T 27. If quantifying this material is required, use AASHTO T 11 in conjunction with AASHTO T 27.

This FOP covers sieve analysis in accordance with AASHTO T 27-20 and materials finer than 75 μm (No. 200) in accordance with AASHTO T 11-20 performed in conjunction with AASHTO T 27. The procedure includes three methods: A, B, and C.

Apparatus

- Balance or scale: Capacity sufficient for the masses shown in Table 1, accurate to 0.1 percent of the sample mass or readable to 0.1 g, and meeting the requirements of AASHTO M 231
- Sieves: Meeting the requirements of ASTM E11
- Mechanical sieve shaker: Meeting the requirements of AASHTO T 27
- Suitable drying equipment (refer to FOP for AASHTO T 255)
- Containers and utensils: A pan or vessel of sufficient size to contain the sample covered with water and permit vigorous agitation without loss of material or water
- Optional
 - Mechanical washing device
 - Mallet: With a rubber or rawhide head having a mass of 0.57 ± 0.23 kg (1.25 ± 0.5 lb)

Sample Sieving

- In all procedures, the sample is shaken in nested sieves. Sieves are selected to furnish information required by specification. Intermediate sieves are added for additional information or to avoid overloading sieves, or both.
- The sieves are nested in order of increasing size from the bottom to the top, and the sample, or a portion of the sample, is placed on the top sieve.
- The loaded sieves are shaken in a mechanical shaker for approximately 10 minutes, refer to Annex A, *Time Evaluation*.

- Care must be taken so that sieves are not overloaded, refer to Annex B, *Overload Determination*. The sample may be sieved in increments and the mass retained for each sieve added together from each sample increment to avoid overloading sieves.

Sample Preparation

Obtain samples according to the FOP for AASHTO R 90 and reduce to sample size, shown in Table 1, according to the FOP for AASHTO R 76.

TABLE 1
Sample Sizes for Aggregate Gradation Test

Nominal Maximum Size* mm (in.)	Minimum Dry Mass g (lb)
125 (5)	300,000 (660)
100 (4)	150,000 (330)
90 (3 1/2)	100,000 (220)
75 (3)	60,000 (130)
63 (2 1/2)	35,000 (77)
50 (2)	20,000 (44)
37.5 (1 1/2)	15,000 (33)
25.0 (1)	10,000 (22)
19.0 (3/4)	5000 (11)
12.5 (1/2)	2000 (4)
9.5 (3/8)	1000 (2)
6.3 (1/4)	1000 (2)
4.75 (No. 4)	500 (1)

*Nominal maximum size: One sieve larger than the first sieve to retain more than 10 percent of the material using an agency specified set of sieves based on cumulative percent retained. Where large gaps between specification sieves exist, intermediate sieve(s) may be inserted to determine nominal maximum size.

Sample sizes in Table 1 are standard for aggregate sieve analysis, due to equipment restraints samples may need to be divided into several “subsamples.” For example, a gradation that requires 100 kg (220 lbs.) of material would not fit into a large tray shaker all at once.

Some agencies permit reduced sample sizes if it is proven that doing so is not detrimental to the test results. Some agencies require larger sample sizes. Check agency guidelines for required or permitted sample sizes.

Selection of Procedure

Agencies may specify which method to perform. If a method is not specified, perform Method A.

Overview**Method A**

- Determine original dry mass of the sample
- Wash over a 75 μ m (No. 200) sieve
- Determine dry mass of washed sample
- Sieve washed sample
- Calculate and report percent retained and passing each sieve

Method B

- Determine original dry mass of the sample
- Wash over a 75 μ m (No. 200) sieve
- Determine dry mass of washed sample
- Sieve sample through coarse sieves, 4.75 mm (No. 4) sieves and larger
- Determine mass of fine material, minus 4.75 mm (No. 4)
- Reduce fine material
- Determine mass of reduced portion
- Sieve reduced portion
- Calculate and report percent retained and passing each sieve

Method C

- Determine original dry mass of the sample
- Sieve sample through coarse sieves, 4.75 mm (No. 4) sieves and larger
- Determine mass of fine material, minus 4.75 mm (No. 4)
- Reduce fine material
- Determine mass of reduced portion
- Wash reduced portion over a 75 μ m (No. 200) sieve
- Determine dry mass of washed reduced portion
- Sieve washed reduced portion
- Calculate and report percent retained and passing each sieve

Procedure Method A

1. Dry the sample to constant mass according to the FOP for AASHTO T 255. Cool to room temperature. Determine and record the original dry mass of the sample to the nearest 0.1 percent or 0.1 g. Designate this mass as *M*.

When the specification does not require the amount of material finer than 75 μm (No. 200) be determined by washing, skip to Step 11.

2. Nest a sieve, such as a 2.0 mm (No. 10), above the 75 μm (No. 200) sieve.
3. Place the sample in a container and cover with water.

Note 1: A detergent, dispersing agent, or other wetting solution may be added to the water to assure a thorough separation of the material finer than the 75 μm (No. 200) sieve from the coarser particles. There should be enough wetting agent to produce a small amount of suds when the sample is agitated. Excessive suds may overflow the sieves and carry material away with them.

4. Agitate vigorously to ensure complete separation of the material finer than 75 μm (No. 200) from coarser particles and bring the fine material into suspension above the coarser material. Avoid degradation of the sample when using a mechanical washing device.

Note 2: Washing longer than 10 minutes in a mechanical washer has been shown to cause significant amounts of degradation depending upon aggregate type.

5. Immediately pour the wash water containing the suspended material over the nested sieves; be careful not to pour out the coarser particles or over fill the 75 μm (No. 200) sieve.
6. Add water to cover material remaining in the container, agitate, and repeat Step 5. Continue until the wash water is reasonably clear.
7. Remove the upper sieve and return material retained to the washed sample.
8. Rinse the material retained on the 75 μm (No. 200) sieve until water passing through the sieve is reasonably clear and detergent or dispersing agent is removed, if used.
9. Return all material retained on the 75 μm (No. 200) sieve to the container by rinsing into the washed sample.

Note 3: Excess water may be carefully removed with a bulb syringe; the removed water must be discharged back over the 75 μm (No. 200) sieve to prevent loss of fines.

10. Dry the washed sample to constant mass according to the FOP for AASHTO T 255. Cool to room temperature. Determine and record the dry mass of the sample.
11. Select sieves required by the specification and those necessary to avoid overloading as described in Annex B. With a pan on bottom, nest the sieves increasing in size starting with the 75 μm (No. 200).
12. Place the sample, or a portion of the sample, on the top sieve. Sieves may already be in the mechanical shaker, if not place sieves in mechanical shaker and shake for the minimum time determined to provide complete separation for the sieve shaker being used (approximately 10 minutes, the time determined by Annex A).

Note 4: Excessive shaking (more than 10 minutes) may result in degradation of the sample.

13. Determine and record the individual or cumulative mass retained for each sieve and in the pan. Ensure that all material trapped in full openings of the sieve are removed and included in the mass retained.

Note 5: For sieves 4.75 mm (No. 4) and larger, check material trapped in less than a full opening by sieving over a full opening. Use coarse wire brushes to clean the 600 µm (No. 30) and larger sieves, and soft bristle brushes for smaller sieves.

Note 6: In the case of coarse / fine aggregate mixtures, distribute the minus 4.75 mm (No. 4) among two or more sets of sieves to prevent overloading of individual sieves.

14. Perform the *Check Sum* calculation – Verify the *total mass after sieving* agrees with the *dry mass before sieving* to within 0.3 percent. The *dry mass before sieving* is the dry mass after wash or the original dry mass (*M*) if performing the sieve analysis without washing. Do not use test results for acceptance if the *Check Sum* result is greater than 0.3 percent.

15. Calculate the total percentages passing, and the individual or cumulative percentages retained to the nearest 0.1 percent by dividing the individual sieve masses or cumulative sieve masses by the original dry mass (*M*) of the sample.

16. Report total percent passing to 1 percent except report the 75 µm (No. 200) sieve to 0.1 percent.

Method A Calculations

Check Sum

$$\text{Check Sum} = \frac{\text{dry mass before sieving} - \text{total mass after sieving}}{\text{dry mass before sieving}} \times 100$$

Percent Retained

$$\text{IPR} = \frac{\text{IMR}}{M} \times 100 \quad \text{or} \quad \text{CPR} = \frac{\text{CMR}}{M} \times 100$$

Where:

IPR	=	Individual Percent Retained
CPR	=	Cumulative Percent Retained
M	=	Original dry mass of the sample
IMR	=	Individual Mass Retained
CMR	=	Cumulative Mass Retained

Percent Passing (PP)

$$PP = PPP - IPR \quad \text{or} \quad PP = 100 - CPR$$

Where:

PP = Percent Passing

PPP = Previous Percent Passing

Method A Example Individual Mass Retained

Original dry mass of the sample (<i>M</i>):	5168.7 g
Dry mass of the sample after washing:	4911.3 g
Total mass after sieving equals	
Sum of Individual Masses Retained (IMR), including minus 75 μm (No. 200) in the pan:	4905.9 g
Amount of 75 μm (No. 200) minus washed out (5168.7 g – 4911.3 g):	257.4 g

Check Sum

$$\text{Check Sum} = \frac{4911.3 \text{ g} - 4905.9 \text{ g}}{4911.3 \text{ g}} \times 100 = 0.1\%$$

The result is less than 0.3 percent therefore the results can be used for acceptance purposes.

Individual Percent Retained (IPR) for 9.5 mm (3/8 in.) sieve:

$$IPR = \frac{619.2 \text{ g}}{5168.7 \text{ g}} \times 100 = 12.0\%$$

Percent Passing (PP) 9.5 mm (3/8 in.) sieve:

$$PP = 86.0\% - 12.0\% = 74.0\%$$

Reported Percent Passing = 74%

**Method A Individual
Gradation on All Sieves**

Sieve Size mm (in.)	Individual Mass Retained g (IMR)	Determine IPR Divide IMR by <i>M</i> and multiply by 100	Individual Percent Retained (IPR)	Determine PP by subtracting IPR from Previous PP	Percent Passing (PP)	Reported Percent Passing*
19.0 (3/4)	0		0		100.0	100
12.5 (1/2)	724.7	$\frac{724.7}{5168.7} \times 100 =$	14.0	$100.0 - 14.0 =$	86.0	86
9.5 (3/8)	619.2	$\frac{619.2}{5168.7} \times 100 =$	12.0	$86.0 - 12.0 =$	74.0	74
4.75 (No. 4)	1189.8	$\frac{1189.8}{5168.7} \times 100 =$	23.0	$74.0 - 23.0 =$	51.0	51
2.36 (No. 8)	877.6	$\frac{877.6}{5168.7} \times 100 =$	17.0	$51.0 - 17.0 =$	34.0	34
1.18 (No. 16)	574.8	$\frac{574.8}{5168.7} \times 100 =$	11.1	$34.0 - 11.1 =$	22.9	23
0.600 (No. 30)	329.8	$\frac{329.8}{5168.7} \times 100 =$	6.4	$22.9 - 6.4 =$	16.5	17
0.300 (No. 50)	228.5	$\frac{228.5}{5168.7} \times 100 =$	4.4	$16.5 - 4.4 =$	12.1	12
0.150 (No. 100)	205.7	$\frac{205.7}{5168.7} \times 100 =$	4.0	$12.1 - 4.0 =$	8.1	8
0.075 (No. 200)	135.4	$\frac{135.7}{5168.7} \times 100 =$	2.6	$8.1 - 2.6 =$	5.5	5.5
minus 0.075 (No. 200) in the pan	20.4					
Total mass after sieving = sum of sieves + mass in the pan = 4905.9 g						
Original dry mass of the sample (<i>M</i>): 5168.7g						

* Report total percent passing to 1 percent except report the 75 μm (No. 200) sieve to 0.1 percent.

Method A Example Cumulative Mass Retained

Original dry mass of the sample (<i>M</i>):	5168.7 g
Dry mass of the sample after washing:	4911.3 g
Total mass after sieving equals Final Cumulative Mass Retained (FCMR) (includes minus 75 µm (No. 200) from the pan):	4905.9 g
Amount of 75µm (No. 200) minus washed out (5168.7 g – 4911.3 g):	257.4 g

Check Sum

$$Check\ Sum = \frac{4911.3\ g - 4905.9\ g}{4911.3\ g} \times 100 = 0.1\%$$

The result is less than 0.3 percent therefore the results can be used for acceptance purposes.

Cumulative Percent Retained (CPR) for 9.5 mm (3/8 in.) sieve:

$$CPR = \frac{1343.9\ g}{5168.7\ g} \times 100 = 26.0\%$$

Percent Passing (PP) 9.5 mm (3/8 in.) sieve:

$$PP = 100.0\% - 26.0\% = 74.0\%$$

Reported Percent Passing = 74%

**Method A Cumulative
Gradation on All Sieves**

Sieve Size mm (in.)	Cumulative Mass Retained g (CMR)	Determine CPR Divide CMR by M and multiply by 100	Cumulative Percent Retained (CPR)	Determine PP by subtracting CPR from 100.0	Percent Passing (PP)	Reported Percent Passing*
19.0 (3/4)	0		0.0		100.0	100
12.5 (1/2)	724.7	$\frac{724.7}{5168.7} \times 100 =$	14.0	$100.0 - 14.0 =$	86.0	86
9.5 (3/8)	1343.9	$\frac{1343.9}{5168.7} \times 100 =$	26.0	$100.0 - 26.0 =$	74.0	74
4.75 (No. 4)	2533.7	$\frac{2533.7}{5168.7} \times 100 =$	49.0	$100.0 - 49.0 =$	51.0	51
2.36 (No. 8)	3411.3	$\frac{3411.3}{5168.7} \times 100 =$	66.0	$100.0 - 66.0 =$	34.0	34
1.18 (No. 16)	3986.1	$\frac{3986.1}{5168.7} \times 100 =$	77.1	$100.0 - 77.1 =$	22.9	23
0.600 (No. 30)	4315.9	$\frac{4315.9}{5168.7} \times 100 =$	83.5	$100.0 - 83.5 =$	16.5	17
0.300 (No. 50)	4544.4	$\frac{4544.4}{5168.7} \times 100 =$	87.9	$100.0 - 87.9 =$	12.1	12
0.150 (No. 100)	4750.1	$\frac{4750.1}{5168.7} \times 100 =$	91.9	$100.0 - 91.9 =$	8.1	8
0.075 (No. 200)	4885.5	$\frac{4885.5}{5168.7} \times 100 =$	94.5	$100.0 - 94.5 =$	5.5	5.5
FCMR	4905.9					
Total mass after sieving: 4905.9 g						
Original dry mass of the sample (M): 5168.7 g						

* Report total percent passing to 1 percent except report the 75 μ m (No. 200) sieve to 0.1 percent.

Procedure Method B

1. Dry the sample to constant mass according to the FOP for AASHTO T 255. Cool to room temperature. Determine and record the original dry mass of the sample to the nearest 0.1 percent or 0.1 g. Designate this mass as *M*.

When the specification does not require the amount of material finer than 75 μm (No. 200) be determined by washing, skip to Step 11.

2. Nest a protective sieve, such as a 2.0 mm (No. 10), above the 75 μm (No. 200) sieve.
3. Place the sample in a container and cover with water.

Note 1: A detergent, dispersing agent, or other wetting solution may be added to the water to assure a thorough separation of the material finer than the 75 μm (No. 200) sieve from the coarser particles. There should be enough wetting agent to produce a small amount of suds when the sample is agitated. Excessive suds may overflow the sieves and carry material away with them.

4. Agitate vigorously to ensure complete separation of the material finer than 75 μm (No. 200) from coarser particles and bring the fine material into suspension above the coarser material. Avoid degradation of the sample when using a mechanical washing device.

Note 2: Washing longer than 10 minutes in a mechanical washer has been shown to cause significant amounts of degradation depending upon aggregate type.

5. Immediately pour the wash water containing the suspended material over the nested sieves; be careful not to pour out the coarser particles or over fill the 75 μm (No. 200) sieve.
6. Add water to cover material remaining in the container, agitate, and repeat Step 5. Continue until the wash water is reasonably clear.
7. Remove the upper sieve and return material retained to the washed sample.
8. Rinse the material retained on the 75 μm (No. 200) sieve until water passing through the sieve is reasonably clear and detergent or dispersing agent is removed, if used.
9. Return all material retained on the 75 μm (No. 200) sieve to the container by rinsing into the washed sample.

Note 3: Excess water may be carefully removed with a bulb syringe; the removed water must be discharged back over the 75 μm (No. 200) sieve to prevent loss of fines.

10. Dry the washed sample to constant mass according to the FOP for AASHTO T 255. Cool to room temperature. Determine and record the dry mass after wash.
11. Select sieves required by the specification and those necessary to avoid overloading as described in Annex B. With a pan on bottom, nest the sieves increasing in size starting with the 4.75 mm (No. 4).
12. Place the sample, or a portion of the sample, on the top sieve. Sieves may already be in the mechanical shaker, if not place the sieves in the mechanical shaker and shake for the minimum time determined to provide complete separation for the sieve shaker being used (approximately 10 minutes, the time determined by Annex A).

Note 4: Excessive shaking (more than 10 minutes) may result in degradation of the sample.

13. Determine and record the individual or cumulative mass retained for each sieve. Ensure that all particles trapped in full openings of the sieve are removed and included in the mass retained.
- Note 5:* For sieves 4.75 mm (No. 4) and larger, check material trapped in less than a full opening by sieving over a full opening. Use coarse wire brushes to clean the 600 μm (No. 30) and larger sieves, and soft hair bristle for smaller sieves.
14. Determine and record the mass of the minus 4.75 mm (No. 4) material in the pan. Designate this mass as M_1 .
15. Perform the *Coarse Check Sum* calculation – Verify the *total mass after coarse sieving* agrees with the *dry mass before sieving* to within 0.3 percent. The *dry mass before sieving* is the dry mass after wash or the original dry mass (M) if performing the sieve analysis without washing. Do not use test results for acceptance if the *Check Sum* result is greater than 0.3 percent.
16. Reduce the minus 4.75 mm (No. 4) according to the FOP for AASHTO R 76 to produce a sample with a minimum mass of 500 g. Determine and record the mass of the minus 4.75 mm (No. 4) split, designate this mass as M_2 .
17. Select sieves required by the specification and those necessary to avoid overloading as described in Annex B. With a pan on bottom, nest the sieves increasing in size starting with the 75 μm (No. 200) up to, but not including, the 4.75 mm (No. 4) sieve.
18. Place the sample portion on the top sieve and place the sieves in the mechanical shaker. Shake for the minimum time determined to provide complete separation for the sieve shaker being used (approximately 10 minutes, the time determined by Annex A).
19. Determine and record the individual or cumulative mass retained for each sieve and in the pan. Ensure that all particles trapped in full openings of the sieve are removed and included in the mass retained.
- Note 6:* For sieves 4.75 mm (No. 4) and larger, check material trapped in less than a full opening by sieving over a full opening. Use coarse wire brushes to clean the 600 μm (No. 30) and larger sieves, and soft hair bristle for smaller sieves.
20. Perform the *Fine Check Sum* calculation – Verify the *total mass after sieving* agrees with the *dry mass before sieving* (M_2) to within 0.3 percent. Do not use test results for acceptance if the *Check Sum* result is greater than 0.3 percent.
21. Calculate to the nearest 0.1 percent, the Individual Mass Retained (IMR) or Cumulative Mass Retained (CMR) of the size increment of the reduced sample and the original sample.
22. Calculate the total percent passing.
23. Report total percent passing to 1 percent except report the 75 μm (No. 200) sieve to 0.1 percent.

Method B Calculations**Check Sum**

$$\text{Coarse Check Sum} = \frac{\text{dry mass before sieving} - \text{total mass after coarse sieving}}{\text{dry mass before sieving}} \times 100$$

$$\text{Fine Check Sum} = \frac{M_2 - \text{total mass after fine sieving}}{M_2} \times 100$$

Percent Retained for 4.75 mm (No. 4) and larger

$$IPR = \frac{IMR}{M} \times 100 \quad \text{or} \quad CPR = \frac{CMR}{M} \times 100$$

Where:

IPR	=	Individual Percent Retained
CPR	=	Cumulative Percent Retained
M	=	Original dry mass of the sample
IMR	=	Individual Mass Retained
CMR	=	Cumulative Mass Retained

Percent Passing (PP) for 4.75 mm (No. 4) and larger

$$PP = PPP - IPR \quad \text{or} \quad PP = 100 - CPR$$

Where:

PP	=	Percent Passing
PPP	=	Previous Percent Passing

Minus 4.75mm (No. 4) adjustment factor (R)

The mass of material retained for each sieve is multiplied by the adjustment factor, the total mass of the minus 4.75 mm (No. 4) from the pan, M_1 , divided by the mass of the reduced split of minus 4.75 mm (No. 4), M_2 . For consistency, this adjustment factor is carried to three decimal places.

$$R = \frac{M_1}{M_2}$$

where:

- R = minus 4.75 mm (No. 4) adjustment factor
- M_1 = total mass of minus 4.75 mm (No. 4) before reducing
- M_2 = mass of the reduced split of minus 4.75 mm (No. 4)

Adjusted Individual Mass Retained (AIMR):

$$AIMR = R \times B$$

where:

- AIMR = Adjusted Individual Mass Retained
- R = minus 4.75 mm (No. 4) adjustment factor
- B = individual mass of the size increment in the reduced portion sieved

Adjusted Cumulative Mass Retained (ACMR)

$$ACMR = (R \times B) + D$$

where:

- ACMR = Adjusted Cumulative Mass Retained
- R = minus 4.75 mm (No. 4) adjustment factor
- B = cumulative mass of the size increment in the reduced portion sieved
- D = cumulative mass of plus 4.75mm (No. 4) portion of sample

Method B Example Individual Mass Retained

Dry mass of total sample, before washing:	3214.0 g
Dry mass of sample after washing:	3085.1 g
Total mass after sieving	
Sum of Individual Masses Retained (IMR) plus the minus 4.75 mm (No. 4) from the pan:	3085.0 g
Amount of 75 µm (No. 200) minus washed out (3214.0 g – 3085.1 g):	128.9 g

Coarse Check Sum

$$\text{Coarse Check Sum} = \frac{3085.1 \text{ g} - 3085.0 \text{ g}}{3085.1 \text{ g}} \times 100 = 0.0\%$$

The result is less than 0.3 percent therefore the results can be used for acceptance purposes.

Individual Percent Retained (IPR) for 9.5 mm (3/8 in.) sieve

$$\text{IPR} = \frac{481.4 \text{ g}}{3214.0 \text{ g}} \times 100 = 15.0\%$$

Percent Passing (PP) for 9.5 mm (3/8 in.) sieve:

$$\text{PP} = 95.0\% - 15.0\% = 80.0\%$$

Reported Percent Passing = 80%

**Method B Individual
Gradation on Coarse Sieves**

Sieve Size mm (in.)	Individual Mass Retained g (IMR)	Determine IPR Divide IMR by M and multiply by 100	Individual Percent Retained (IPR)	Determine PP by subtracting IPR from Previous PP	Percent Passing (PP)
16.0 (5/8)	0		0		100
12.5 (1/2)	161.1	$\frac{161.1}{3214.0} \times 100 =$	5.0	$100.0 - 5.0 =$	95.0
9.50 (3/8)	481.4	$\frac{481.4}{3214.0} \times 100 =$	15.0	$95.0 - 15.0 =$	80.0
4.75 (No. 4)	475.8	$\frac{475.8}{3214.0} \times 100 =$	14.8	$80.0 - 14.8 =$	65.2
Minus 4.75 (No. 4) in the pan	1966.7 (M_1)				
Total mass after sieving: sum of sieves + mass in the pan = 3085.0 g					
Original dry mass of the sample (M): 3214.0 g					

Fine Sample

The minus 4.75 mm (No. 4) from the pan, M_1 (1966.7 g), was reduced according to the FOP for AASHTO R 76, to at least 500 g. In this case, the reduced mass was determined to be **512.8 g**. This is M_2 .

The reduced mass was sieved.

Total mass after sieving equals

Sum of Individual Masses Retained (IMR) including minus 75 μ m (No. 200) in the pan	511.8 g
--	---------

Fine Check Sum

$$\text{Fine Check Sum} = \frac{512.8 \text{ g} - 511.8 \text{ g}}{512.8 \text{ g}} \times 100 = 0.2\%$$

The result is less than 0.3 percent therefore the results can be used for acceptance purposes.

Adjustment Factor (R) for Adjusted Individual Mass Retained (AIMR) on minus 4.75 (No. 4) sieves

The mass of material retained for each sieve is multiplied by the adjustment factor (*R*) carried to three decimal places.

$$R = \frac{M_1}{M_2} = \frac{1,966.7 \text{ g}}{512.8 \text{ g}} = 3.835$$

where:

- R = minus 4.75 mm (No. 4) adjustment factor
- M₁ = total mass of minus 4.75 mm (No. 4) from the pan
- M₂ = mass of the reduced split of minus 4.75 mm (No. 4)

Each “individual mass retained” on the fine sieves must be multiplied by *R* to obtain the *Adjusted Individual Mass Retained*.

Adjusted Individual Mass Retained (AIMR) for 2.00 mm (No. 10) sieve

$$\text{AIMR} = 3.835 \times 207.1 \text{ g} = 794.2 \text{ g}$$

Individual Percent Retained (IPR) for 2.00 mm (No. 10) sieve:

$$\text{IPR} = \frac{794.2 \text{ g}}{3214.0 \text{ g}} \times 100 = 24.7\%$$

Percent Passing (PP) 2 mm (No. 10) sieve:

$$PP = 65.2\% - 24.7\% = 40.5\%$$

Reported Percent Passing = 41%

**Method B Individual
Gradation on Fine Sieves**

Sieve Size mm (in.)	Individual Mass Retained g (IMR)	Determine TIMR Multiply IMR by $R \left(\frac{M_1}{M_2} \right)$	Total Individual Mass Retained (TIMR)
2.00 (No. 10)	207.1	$207.1 \times 3.835 =$	794.2
0.425 (No. 40)	187.9	$187.9 \times 3.835 =$	720.6
0.210 (No. 80)	59.9	$59.9 \times 3.835 =$	229.7
0.075 (No. 200)	49.1	$49.1 \times 3.835 =$	188.3
minus 0.075 (No. 200) in the pan	7.8		
Total mass after sieving: sum of fine sieves + the mass in the pan = 511.8 g			

**Method B Individual
Final Gradation on All Sieves**

Sieve Size mm (in.)	Total Individual Mass Retained g (TIMR)	Determine IPR Divide TIMR by M and multiply by 100	Individual Percent Retained (IPR)	Determine PP by subtracting IPR from Previous PP	Percent Passing (PP)	Reported Percent Passing*
16.0 (5/8)	0		0		100	100
12.5 (1/2)	161.1	$\frac{161.1}{3214.0} \times 100 =$	5.0	$100.0 - 5.0 =$	95.0	95
9.50 (3/8)	481.4	$\frac{481.4}{3214.0} \times 100 =$	15.0	$95.0 - 15.0 =$	80.0	80
4.75 (No. 4)	475.8	$\frac{475.8}{3214.0} \times 100 =$	14.8	$80.0 - 14.8 =$	65.2	65
2.00 (No. 10)	794.2	$\frac{794.2}{3214.0} \times 100 =$	24.7	$65.2 - 24.7 =$	40.5	41
0.425 (No. 40)	720.6	$\frac{720.6}{3214.0} \times 100 =$	22.4	$40.5 - 22.4 =$	18.1	18
0.210 (No. 80)	229.7	$\frac{229.7}{3214.0} \times 100 =$	7.1	$18.1 - 7.1 =$	11.0	11
0.075 (No. 200)	188.3	$\frac{188.3}{3214.0} \times 100 =$	5.9	$11.0 - 5.9 =$	5.1	5.1
minus 0.075 (No. 200) in the pan	29.9					
Original dry mass of the sample (M): 3214.0 g						

* Report total percent passing to 1 percent except report the 75 μ m (No. 200) sieve to 0.1 percent.

Method B Example Cumulative Mass Retained

Original dry mass of the sample (<i>M</i>):	3214.0 g
Dry mass of sample after washing:	3085.1 g
Total mass after sieving equals	
Cumulative Mass Retained (CMR) on the 4.75 (No. 4) plus the minus 4.75 mm (No. 4) in the pan:	3085.0 g
Amount of 75 μm (No. 200) minus washed out (3214.0 g – 3085.1 g):	128.9 g

Coarse Check Sum

$$\text{Coarse Check Sum} = \frac{3085.1 \text{ g} - 3085.0 \text{ g}}{3085.1 \text{ g}} \times 100 = 0.0\%$$

The result is less than 0.3 percent therefore the results can be used for acceptance purposes.

Cumulative Percent Retained (CPR) for 9.5 mm (3/8 in.) sieve

$$CPR = \frac{642.5 \text{ g}}{3214.0 \text{ g}} \times 100 = 20.0\%$$

Percent Passing (PP) for 9.5 mm (3/8 in.) sieve

$$PP = 100.0\% - 20.0\% = 80.0\%$$

Reported Percent Passing = 80%

**Method B Cumulative
Gradation on Coarse Sieves**

Sieve Size mm (in.)	Cumulative Mass Retained g (CMR)	Determine CPR Divide CMR by M and multiply by 100	Cumulative Percent Retained (CPR)	Determine PP by subtracting CPR from 100.0	Percent Passing (PP)
16.0 (5/8)	0		0		100
12.5 (1/2)	161.1	$\frac{161.1}{3214.0} \times 100 =$	5.0	$100.0 - 5.0 =$	95.0
9.50 (3/8)	642.5	$\frac{642.5}{3214.0} \times 100 =$	20.0	$100.0 - 20.0 =$	80.0
4.75 (No. 4)	1118.3 (<i>D</i>)	$\frac{1118.3}{3214.0} \times 100 =$	34.8	$100.0 - 34.8 =$	65.2
Minus 4.75 (No. 4) in the pan	1966.7 (<i>M_I</i>)				
CMR: $1118.3 + 1966.7 = 3085.0$					
Original dry mass of the sample (<i>M</i>): 3214.0 g					

Fine Sample

The mass of minus 4.75 mm (No. 4) material in the pan, *M_I* (1966.7 g), was reduced according to the FOP for AASHTO R 76, to at least 500 g. In this case, the reduced mass was determined to be **512.8 g**. This is *M₂*.

The reduced mass was sieved.

Total mass after fine sieving equals

Final Cumulative Mass Retained (FCMR) (includes minus
75 μm (No. 200) from the pan): 511.8 g

Fine Check Sum

$$\text{Fine Check Sum} = \frac{512.8 \text{ g} - 511.8 \text{ g}}{512.8 \text{ g}} \times 100 = 0.2\%$$

The result is less than 0.3 percent therefore the results can be used for acceptance purposes.

The cumulative mass of material retained for each sieve is multiplied by the adjustment factor (R) carried to three decimal places and added to the cumulative mass retained on the 4.75 mm (No. 4) sieve, D , to obtain the *Adjusted Cumulative Mass Retained (ACMR)*.

Adjustment factor (R) for Cumulative Mass Retained (CMR) in minus 4.75 (No. 4) sieves

$$R = \frac{M_1}{M_2} = \frac{1,966.7 \text{ g}}{512.8 \text{ g}} = 3.835$$

where:

- R = minus 4.75 mm (No. 4) adjustment factor
- M_1 = total mass of minus 4.75 mm (No. 4) from the pan
- M_2 = mass of the reduced split of minus 4.75 mm (No. 4)

Adjusted Cumulative Mass Retained (ACMR) for the 2.00 mm (No. 10) sieve

$$ACMR = 3.835 \times 207.1 \text{ g} = 794.2 \text{ g}$$

Total Cumulative Mass Retained (TCMR) for the 2.00 mm (No. 10) sieve

$$TCMR = 794.2 \text{ g} + 1118.3 \text{ g} = 1912.5 \text{ g}$$

Cumulative Percent Retained (CPR) for 2.00 mm (No. 10) sieve:

$$CPR = \frac{1912.5 \text{ g}}{3214.0 \text{ g}} \times 100 = 59.5\%$$

Percent Passing (PP) 2.00 mm (No. 10) sieve:

$$PP = 100.0\% - 59.5\% = 40.5\%$$

Reported Percent Passing = 41%

**Method B Cumulative
Gradation on Fine Sieves**

Sieve Size mm (in.)	Cumulative Mass Retained, g (CMR)	Determine AIMR Multiply IMR by $R \left(\frac{M_1}{M_2} \right)$ and adding D	Total Cumulative Mass Retained (TCMR)
2.00 (No. 10)	207.1	$207.1 \times 3.835 + 1118.3 =$	1912.5
0.425 (No. 40)	395.0	$395.0 \times 3.835 + 1118.3 =$	2633.1
0.210 (No. 80)	454.9	$454.9 \times 3.835 + 1118.3 =$	2862.8
0.075 (No. 200)	504.0	$504.0 \times 3.835 + 1118.3 =$	3051.1
FCMR	511.8		
Total: sum of masses on fine sieves + minus 75 μm (No. 200) in the pan = 511.8			

**Method B Cumulative
Final Gradation on All Sieves**

Sieve Size mm (in.)	Cumulative Mass Retained g (CMR)	Determine CPR Divide CMR by M and multiply by 100	Cumulative Percent Retained (CPR)	Determine PP by subtracting CPR from 100.0	Percent Passing (PP)	Reported Percent Passing*
16.0 (5/8)	0		0		100.0	100
12.5 (1/2)	161.1	$\frac{161.1}{3214.0} \times 100 =$	5.0	$100.0 - 5.0 =$	95.0	95
9.5 (3/8)	642.5	$\frac{642.5}{3214.0} \times 100 =$	20.0	$100.0 - 20.0 =$	80.0	80
4.75 (No. 4)	1118.3 (D)	$\frac{1118.3}{3214.0} \times 100 =$	34.8	$100.0 - 34.8 =$	65.2	65
2.00 (No. 10)	1912.5	$\frac{1912.5}{3214.0} \times 100 =$	59.5	$100.0 - 59.5 =$	40.5	41
0.425 (No. 40)	2633.1	$\frac{2633.1}{3214.0} \times 100 =$	81.9	$100.0 - 81.9 =$	18.1	18
0.210 (No. 80)	2862.8	$\frac{2862.8}{3214.0} \times 100 =$	89.1	$100.0 - 89.1 =$	10.9	11
0.075 (No. 200)	3051.1	$\frac{3051.1}{3214.0} \times 100 =$	94.9	$100.0 - 94.9 =$	5.1	5.1
FCMR	3081.1					
Original dry mass of the sample (M): 3214.0 g						

* Report total percent passing to 1 percent except report the 75 µm (No. 200) sieve to 0.1 percent.

Procedure Method C

1. Dry the sample to constant mass according to the FOP for AASHTO T 255. Cool to room temperature. Determine and record the original dry mass of the sample to the nearest 0.1 percent or 0.1 g. Designate this mass as M .
2. Break up any aggregations or lumps of clay, silt, or adhering fines to pass the 4.75 mm (No. 4) sieve.
3. Select sieves required by the specification and those necessary to avoid overloading as described in Annex B. With a pan on bottom, nest the sieves increasing in size starting with the 4.75 mm (No. 4) sieve.
4. Place the sample, or a portion of the sample, on the top sieve. Sieves may already be in the mechanical shaker, if not place the sieves in the mechanical shaker and shake for the minimum time determined to provide complete separation for the sieve shaker being used (approximately 10 minutes, the time determined by Annex A).

Note 1: Excessive shaking (more than 10 minutes) may result in degradation of the sample.

5. Determine and record the cumulative mass retained for each sieve. Ensure that all material trapped in full openings of the sieve are removed and included in the mass retained.

Note 2: For sieves 4.75 mm (No. 4) and larger, check material trapped in less than a full opening sieving over a full opening. Use coarse wire brushes to clean the 600 μm (No. 30) and larger sieves, and soft bristle brush for smaller sieves.

6. Determine and record the mass of the minus 4.75 mm (No. 4) material in the pan. Designate this mass as M_1 .
7. Perform the *Coarse Check Sum* calculation –Verify the *total mass after coarse sieving* agrees with the *original dry mass (M)* within 0.3 percent.
8. Reduce the minus 4.75 mm (No. 4) according to the FOP for AASHTO R 76, to produce a sample with a minimum mass of 500 g.
9. Determine and record the mass of the minus 4.75 mm (No. 4) split, designate this mass as M_3 .
10. Nest a protective sieve, such as a 2.0 mm (No. 10), above the 75 μm (No. 200) sieve.
11. Place the sample in a container and cover with water.

Note 3: A detergent, dispersing agent, or other wetting solution may be added to the water to assure a thorough separation of the material finer than the 75 μm (No. 200) sieve from the coarser particles. There should be enough wetting agent to produce a small amount of suds when the sample is agitated. Excessive suds may overflow the sieves and carry material away with them.

12. Agitate vigorously to ensure complete separation of the material finer than 75 μm (No. 200) from coarser particles and bring the fine material into suspension above the coarser material. Avoid degradation of the sample when using a mechanical washing device.

Note 4: Washing longer than 10 minutes in a mechanical washer has been shown to cause significant amounts of degradation depending upon aggregate type.

13. Immediately pour the wash water containing the suspended material over the nested sieves; be careful not to pour out the coarser particles or over fill the 75 μm (No. 200) sieve.
14. Add water to cover material remaining in the container, agitate, and repeat Step 12. Repeat until the wash water is reasonably clear.
15. Remove the upper sieve and return material retained to the washed sample.
16. Rinse the material retained on the 75 μm (No. 200) sieve until water passing through the sieve is reasonably clear and detergent or dispersing agent is removed, if used.
17. Return all material retained on the 75 μm (No. 200) sieve to the container by flushing into the washed sample.

Note 5: Excess water may be carefully removed with a bulb syringe; the removed water must be discharged back over the 75 μm (No. 200) sieve to prevent loss of fines.

18. Dry the washed sample portion to constant mass according to the FOP for AASHTO T 255. Cool to room temperature. Determine and record the dry mass, designate this mass as *dry mass before sieving*.
19. Select sieves required by the specification and those necessary to avoid overloading as described in Annex B. With a pan on bottom, nest the sieves increasing in size starting with the 75 μm (No. 200) sieve up to, but not including, the 4.75 mm (No. 4) sieve.
20. Place the sample portion on the top sieve. Place the sieves in the mechanical shaker and shake for the minimum time determined to provide complete separation for the sieve shaker being used (approximately 10 minutes, the time determined by Annex A).

Note 6: Excessive shaking (more than 10 minutes) may result in degradation of the sample.

21. Determine and record the cumulative mass retained for each sieve. Ensure that all material trapped in full openings of the sieve are removed and included in the mass retained.

Note 7: For sieves 4.75 mm (No. 4) and larger, check material trapped in less than a full opening by sieving over a full opening. Use coarse wire brushes to clean the 600 μm (No. 30) and larger sieves, and soft bristle brushes for smaller sieves.

22. Perform the *Fine Check Sum* calculation – Verify the *total mass after fine sieving* agrees with the *dry mass before sieving* within 0.3 percent. Do not use test results for acceptance if the *Check Sum* is greater than 0.3 percent.
23. Calculate the Cumulative Percent Retained (CPR) and Percent Passing (PP) for the 4.75 mm (No. 4) and larger.
24. Calculate the Cumulative Percent Retained (CPR_{-#4}) and the Percent Passing (PP_{-#4}) for minus 4.75 mm (No. 4) split and Percent Passing (PP) for the minus 4.75 mm (No. 4).
25. Report total percent passing to 1 percent except report the 75 μm (No. 200) sieve to 0.1 percent.

Method C Calculations

Check Sum

$$\text{Coarse check sum} = \frac{M - \text{total mass after coarse sieving}}{M} \times 100$$

$$\text{Fine check sum} = \frac{\text{dry mass before sieving} - \text{total mass after fine sieving}}{\text{dry mass before sieving}} \times 100$$

where:

M = Original dry mass of the sample

Cumulative Percent Retained (CPR) for 4.75 mm (No. 4) sieve and larger

$$CPR = \frac{CMR}{M} \times 100$$

where:

CPR = Cumulative Percent Retained of the size increment for the total sample

CMR = Cumulative Mass Retained of the size increment for the total sample

M = Total dry sample mass before washing

Percent Passing (PP) 4.75 mm (No. 4) sieve and larger

$$PP = 100 - CPR$$

where:

PP = Percent Passing of the size increment for the total sample

CPR = Cumulative Percent Retained of the size increment for the total sample

Or, calculate PP for sieves larger than 4.75 mm (No. 4) sieve without calculating CPR

$$\frac{M - CMR}{M} \times 100$$

Cumulative Percent Retained (CPR_{#4}) for minus 4.75 mm (No. 4) split

$$CPR_{\#4} = \frac{CMR_{\#4}}{M_3} \times 100$$

where:

- CPR_{#4} = Cumulative Percent Retained for the sieve sizes of M₃
 CMR_{#4} = Cumulative Mass Retained for the sieve sizes of M₃
 M₃ = Total mass of the minus 4.75 mm (No. 4) split before washing

Percent Passing (PP_{#4}) for minus 4.75 mm (No. 4) split

$$PP_{\#4} = 100 - CPR_{\#4}$$

where:

- PP_{#4} = Percent Passing for the sieve sizes of M₃
 CPR_{#4} = Cumulative Percent Retained for the sieve sizes of M₃

Percent Passing (PP) for sieves smaller than 4.75 mm (No. 4) sieve

$$PP = \frac{(PP_{\#4} \times \#4 PP)}{100}$$

where:

- PP = Total Percent Passing
 PP_{#4} = Percent Passing for the sieve sizes of M₃
 #4 PP = Total Percent Passing the 4.75 mm (No. 4) sieve

Or, calculate PP for sieves smaller than 4.75 mm (No. 4) sieve without calculating CPR-#4 and PP-#4

$$PP = \frac{\#4 PP}{M_3} \times (M_3 - CMR_{\#4})$$

where:

- PP = Total Percent Passing
 #4 PP = Total Percent Passing the 4.75 mm (No. 4) sieve
 M₃ = Total mass of the minus 4.75 mm (No. 4) split before washing
 CMR-#4 = Cumulative Mass Retained for the sieve sizes of M₃

Method C Example

Original dry mass of the sample (*M*): 3304.5 g

Total mass after sieving equals

Cumulative Mass Retained (CMR) on the 4.75 (No. 4) plus the minus 4.75 mm (No. 4) from the pan: 3085.0 g

Coarse Check Sum

$$Coarse\ Check\ Sum = \frac{3304.5\ g - 3304.5\ g}{3304.5\ g} \times 100 = 0.0\%$$

The result is less than 0.3 percent therefore the results can be used for acceptance purposes.

Cumulative Percent Retained (CPR) for the 9.5 mm (3/8 in.) sieve:

$$CPR = \frac{604.1\ g}{3304.5\ g} \times 100 = 18.3\%$$

Percent Passing (PP) for the 9.5 mm (3/8 in.) sieve:

$$PP = 100.0\% - 18.3\% = 81.7\%$$

Reported Percent Passing = 82%

Example for Alternate Percent Passing (PP) formula for the 9.5 mm (3/8 in.) sieve:

$$PP = \frac{3304.5 - 604.1}{3304.5} \times 100 = 81.7\%$$

Reported Percent Passing = 82%

**Method C Cumulative
Gradation on Coarse Sieves**

Sieve Size mm (in.)	Cumulative Mass Retained, g (CMR)	Determine CPR Divide CMR by M and multiply by 100	Cumulative Percent Retained (CPR)	Determine PP by subtracting CPR from 100.0	Percent Passing (PP)	Reported Percent Passing*
16.0 (5/8)	0		0.0		100.0	100
12.5 (1/2)	125.9	$\frac{125.9}{3304.5} \times 100 =$	3.8	$100.0 - 3.8 =$	96.2	96
9.50 (3/8)	604.1	$\frac{604.1}{3304.5} \times 100 =$	18.3	$100.0 - 18.3 =$	81.7	82
4.75 (No. 4)	1295.6	$\frac{1295.6}{3304.5} \times 100 =$	39.2	$100.0 - 39.2 =$	60.8 (#4 PP)	61
Mass in pan	2008.9					
CMR: 1295.6 + 2008.9 = 3304.5						
Original dry mass of the sample (M): 3304.5						

Fine Sample

The pan (2008.9 g) was reduced according to the FOP for AASHTO R 76, to at least 500 g. In this case, the reduced mass was determined to be **527.6 g**. This is M_3 .

Dry mass of minus 4.75mm (No. 4) reduced portion before wash (M_3): 527.6 g

Dry mass of minus 4.75mm (No. 4) reduced portion after wash: 495.3 g

Total mass after fine sieving equals

Final Cumulative Mass Retained (FCMR)
(includes minus 75 μm (No. 200) from the pan): 495.1 g

Fine Check Sum

$$\text{Fine Check Sum} = \frac{495.3 \text{ g} - 495.1 \text{ g}}{495.3 \text{ g}} \times 100 = 0.04\%$$

The result is less than 0.3 percent therefore the results can be used for acceptance purposes.

Cumulative Percent Retained (CPR_{#4}) for minus 4.75 mm (No. 4) for the 2.0 mm (No. 10) sieve:

$$CPR_{\#4} = \frac{194.3 \text{ g}}{527.6 \text{ g}} \times 100 = 36.8\%$$

Percent Passing (PP_{#4}) for minus 4.75 mm (No. 4) for the 2.0 mm (No. 10) sieve:

$$PP_{\#4} = 100.0\% - 36.8\% = 63.2\%$$

**Method C Cumulative
Gradation on Fine Sieves**

77

Sieve Size mm (in.)	Cumulative Mass Retained g (CMR _{#4})	Determine CPR _{#4} Divide CMR by M ₃ and multiply by 100	Cumulative Percent Retained _{#4} (CPR _{#4})	Determine PP _{#4} by subtracting CPR _{#4} from 100.0	Percent Passing _{#4} (PP _{#4})
2.0 (No. 10)	194.3	$\frac{194.3}{527.6} \times 100 =$	36.8	$100.0 - 36.8 =$	63.2
0.425 (No. 40)	365.6	$\frac{365.6}{527.6} \times 100 =$	69.3	$100.0 - 69.3 =$	30.7
0.210 (No. 80)	430.8	$\frac{430.8}{527.6} \times 100 =$	81.7	$100.0 - 81.7 =$	18.3
0.075 (No. 200)	484.4	$\frac{484.4}{527.6} \times 100 =$	91.8	$100.0 - 91.8 =$	8.2
FCMR	495.1				
Dry mass of minus 4.75mm (No. 4) reduced portion before wash (M ₃): 527.6 g					
Dry mass after washing: 495.3 g					

Percent Passing (PP) for the 2.0 mm (No. 10) sieve for the entire sample:

78

#4 PP (Total Percent Passing the 4.75 mm (No. 4) sieve) = 60.8%

$$PP = \frac{63.2\% \times 60.8\%}{100} = 38.4\%$$

Reported Percent Passing = 38%

**Method C Cumulative
Final Gradation on All Sieves**

Sieve Size mm (in.)	Cumulative Mass Retained g (CMR)	Cumulative Percent Retained (CPR)	Percent Passing (PP -#4)	Determine PP multiply PP -#4 by #4 PP and divide by 100	Percent Passing (PP)	Reported Percent Passing*
16.0 (5/8)	0	0.0			100.0	100
12.5 (1/2)	125.9	3.8			96.2	96
9.5 (3/8)	604.1	18.3			81.7	82
4.75 (No. 4)	1295.6	39.2			60.8 (#4 PP)	61
2.0 (No. 10)	194.3	36.8	63.2	$\frac{63.2 \times 60.8}{100} =$	38.4	38
0.425 (No. 40)	365.6	69.3	30.7	$\frac{30.7 \times 60.8}{100} =$	18.7	19
0.210 (No. 80)	430.8	81.7	18.3	$\frac{18.3 \times 60.8}{100} =$	11.1	11
0.075 (No. 200)	484.4	91.8	8.2	$\frac{8.2 \times 60.8}{100} =$	5.0	5.0
FCMR	495.1					

* Report total percent passing to 1 percent except report the 75 µm (No. 200) sieve to 0.1 percent.

Example for Alternate Percent Passing (PP) for the 4.75 mm (No. 4) sieve for the entire sample:

#4 PP (Total Percent Passing the 4.75 mm (No. 4) sieve) = 60.8%

$$PP = \frac{60.8\%}{527.6} \times (527.6 - 194.3) = 38.4\%$$

Reported Percent Passing = 38%

Alternate Method C Cumulative Gradation on Coarse Sieves

Sieve Size mm (in.)	Cumulative Mass Retained, g (CMR)	Determine PP subtract CMR from M, divide result by M multiply by 100	Percent Passing (PP)	Reported Percent Passing*
16.0 (5/8)	0.0		100.0	100
12.5 (1/2)	125.9	$\frac{3304.5 - 125.9}{3304.5} \times 100 =$	96.2	96
9.5 (3/8)	604.1	$\frac{3304.5 - 604.1}{3304.5} \times 100 =$	81.7	82
4.75 (No. 4)	1295.6	$\frac{3304.5 - 1295.6}{3304.5} \times 100 =$	60.8 (#4 PP)	61
Mass in Pan	2008.9			
Cumulative sieved mass: 1295.6 + 2008.9 = 3304.5				
Original dry mass of the sample (M): 3304.5				

**Alternate Method C Cumulative
Gradation on Fine Sieves**

Sieve Size mm (in.)	Cumulative Mass Retained g (CMR _{#4})	Determine PP _{#4} subtract CMR _{#4} from M ₃ , divide result by M ₃ multiply by 100	Percent Passing _{#4} (PP _{#4})
2.0 (No. 10)	194.3	$\frac{527.6 - 194.3}{527.6} \times 100 =$	63.2
0.425 (No. 40)	365.6	$\frac{527.6 - 365.6}{527.6} \times 100 =$	30.7
0.210 (No. 80)	430.8	$\frac{527.6 - 430.8}{527.6} \times 100 =$	18.3
0.075 (No. 200)	484.4	$\frac{527.6 - 484.4}{527.6} \times 100 =$	8.2
FCMR	495.1		
Dry mass of minus 4.75mm (No. 4) reduced portion before wash (M ₃): 527.6 g			
Dry mass after washing: 495.3 g			

**Alternate Method C Cumulative
Final Gradation on All Sieves**

Sieve Size mm (in.)	Percent Passing ^{#4} (PP ^{#4})	Determine PP multiply PP ^{#4} by #4 PP and divide by 100	Determined Percent Passing (PP)	Reported Percent Passing*
16.0 (5/8)			100.0	100
12.5 (1/2)			96.2	96
9.5 (3/8)			81.7	82
4.75 (No. 4)			60.8 (#4 PP)	61
2.0 (No. 10)	63.2	$\frac{63.2 \times 60.8}{100} =$	38.4	38
0.425 (No. 40)	30.7	$\frac{30.7 \times 60.8}{100} =$	18.7	19
0.210 (No. 80)	18.3	$\frac{18.3 \times 60.8}{100} =$	11.1	11
0.075 (No. 200)	8.2	$\frac{8.2 \times 60.8}{100} =$	5.0	5.0

* Report total percent passing to 1 percent except report the 75 μm (No. 200) sieve to 0.1 percent.

FINENESS MODULUS

Fineness Modulus (FM) is used in determining the degree of uniformity of the aggregate gradation in PCC mix designs. It is an empirical number relating to the fineness of the aggregate. The higher the FM the coarser the aggregate. Values of 2.40 to 3.00 are common for fine aggregate in PCC.

The sum of the cumulative percentages retained on specified sieves in the following table divided by 100 gives the FM.

Sample Calculation

	Example A			Example B		
	Percent			Percent		
		Retained			Retained	
Sieve Size mm (in)	Passing		On Spec'd Sieves*	Passing		On Spec'd Sieves*
75*(3)	100	0	0	100	0	0
37.5*(11/2)	100	0	0	100	0	0
19*(3/4)	15	85	85	100	0	0
9.5*(3/8)	0	100	100	100	0	0
4.75*(No.4)	0	100	100	100	0	0
2.36*(No.8)	0	100	100	87	13	13
1.18*(No.16)	0	100	100	69	31	31
0.60*(No.30)	0	100	100	44	56	56
0.30*(No.50)	0	100	100	18	82	82
0.15*(100)	0	100	100	4	96	96
			$\Sigma = 785$			$\Sigma = 278$
			FM = 7.85			FM = 2.78

In decreasing size order, each * sieve is one-half the size of the preceding * sieve.

Report

- On forms approved by the agency
- Sample ID
- Percent passing for each sieve
- Individual mass retained for each sieve
- Individual percent retained for each sieve
- or
- Cumulative mass retained for each sieve
- Cumulative percent retained for each sieve
- FM to the nearest 0.01

Report percentages to the nearest 1 percent except for the percent passing the 75 μm (No. 200) sieve, which shall be reported to the nearest 0.1 percent.

ANNEX A**Time Evaluation**

(Mandatory information)

The sieving time for each mechanical sieve shaker shall be checked at least annually to determine the time required for complete separation of the sample by the following method:

1. Shake the sample over nested sieves for approximately 10 minutes.
2. Provide a snug-fitting pan and cover for each sieve and hold in a slightly inclined position in one hand.
3. Hand shake each sieve by striking the side of the sieve sharply and with an upward motion against the heel of the other hand at the rate of about 150 times per minute, turning the sieve about one sixth of a revolution at intervals of about 25 strokes.

Note A1: A mallet may be used instead of the heel of the hand if comparable force is used.

If more than 0.5 percent by mass of the total sample before sieving passes any sieve after one minute of continuous hand shaking adjust shaker time and re-check.

In determining sieving time for sieve sizes larger than 4.75 mm (No. 4), limit the material on the sieve to a single layer of particles.

ANNEX B**Overload Determination**

(Mandatory information)

Additional sieves may be necessary to keep from overloading sieves or to provide other information, such as fineness modulus. The sample may also be sieved in increments to prevent overloading.

- For sieves with openings smaller than 4.75 mm (No. 4), the mass retained on any sieve shall not exceed 7 kg/m² (4 g/in²) of sieving surface.
- For sieves with openings 4.75 mm (No. 4) and larger, the mass, in grams shall not exceed the product of 2.5 × (sieve opening in mm) × (effective sieving area). See Table B1.

TABLE B1

Maximum Allowable Mass of Material Retained on a Sieve, g
Nominal Sieve Size, mm (in.)
Exact size is smaller (see AASHTO T 27)

Sieve Size		203 dia	305 dia	305 by 305	350 by 350	372 by 580
mm (in.)		(8)	(12)	(12 × 12)	(14 × 14)	(16 × 24)
		Sieving Area m ²				
		0.0285	0.0670	0.0929	0.1225	0.2158
90	(3 1/2)	*	15,100	20,900	27,600	48,500
75	(3)	*	12,600	17,400	23,000	40,500
63	(2 1/2)	*	10,600	14,600	19,300	34,000
50	(2)	3600	8400	11,600	15,300	27,000
37.5	(1 1/2)	2700	6300	8700	11,500	20,200
25.0	(1)	1800	4200	5800	7700	13,500
19.0	(3/4)	1400	3200	4400	5800	10,200
16.0	(5/8)	1100	2700	3700	4900	8600
12.5	(1/2)	890	2100	2900	3800	6700
9.5	(3/8)	670	1600	2200	2900	5100
6.3	(1/4)	440	1100	1500	1900	3400
4.75	(No. 4)	330	800	1100	1500	2600
-4.75	(-No. 4)	200	470	650	860	1510



Oregon

Kate Brown, Governor

Department of Transportation

Construction Section
800 Airport Road SE
Salem, OR 97301-4792
Phone: (503) 986-3000
Fax: (503) 986-3096

October 31, 2020

To: All Holders of the Manual of Field Test Procedures

Section: **Test Procedure AASHTO T 30**

The Oregon Department of Transportation has specified method(s) for this Test Procedure. Please observe the following for our projects:

- **Under Mass Verification Section – Delete the second and third sentence.**
- **Under Procedure step 2 – Dispersing agents or wetting solutions are optional.**
- **Under Procedure step 7 – delete this step**
- **Under Procedure step 11 - Shaking time will be a minimum of 10 minutes.**
- **Under Procedure step 15 – Aggregate Correction Factors are at the option of the Engineer.**
- **Under Reporting section, 3rd bullet - Aggregate Correction Factors are at the option of the Engineer.**

MECHANICAL ANALYSIS OF EXTRACTED AGGREGATE FOP FOR AASHTO T 30

Scope

This procedure covers mechanical analysis of aggregate recovered from asphalt mix samples in accordance with AASHTO T 30-19. This FOP utilizes the aggregate recovered from the ignition furnace used in AASHTO T 308. AASHTO T 30 was developed for analysis of extracted aggregate and thus includes references to extracted bitumen and filter element, which do not apply in this FOP.

Sieve analyses determine the gradation or distribution of aggregate particles within a given sample in order to determine compliance with design and production standards.

Apparatus

- Balance or scale: Capacity sufficient for the sample mass, accurate to 0.1 percent of the sample mass or readable to 0.1 g
- Sieves, meeting the requirements of FOP for AASHTO T 27/T 11.
- Mechanical sieve shaker, meeting the requirements of FOP for AASHTO T 27/T 11.
- Mechanical Washing Apparatus (optional)
- Suitable drying equipment, meeting the requirements of the FOP for AASHTO T 255.
- Containers and utensils: A pan or vessel of a size sufficient to contain the sample covered with water and to permit vigorous agitation without loss of any part of the sample or water.

Sample Sieving

- In this procedure, it is required to shake the sample over nested sieves. Sieves are selected to furnish information required by specification. Intermediate sieves are added for additional information or to avoid overloading sieves, or both.
- The sieves are nested in order of increasing size from the bottom to the top, and the test sample, or a portion of the test sample, is placed on the top sieve.
- The loaded sieves are shaken in a mechanical shaker for approximately 10 minutes, refer to Annex A; *Time Evaluation*.

Mass Verification

Using the aggregate sample obtained from the FOP for AASHTO T 308, determine and record the mass of the sample, $M_{(T30)}$, to 0.1 g. This mass shall agree with the mass of the aggregate remaining after ignition, M_f from T 308, within 0.10 percent. If the variation exceeds 0.10 percent, the results cannot be used for acceptance.

Calculation

$$\text{Mass verification} = \frac{M_{f(T308)} - M_{(T30)}}{M_{f(T308)}} \times 100$$

Where:

$M_{f(T308)}$ = Mass of aggregate remaining after ignition from the FOP for AASHTO T 308

$M_{(T30)}$ = Mass of aggregate sample obtained from the FOP for AASHTO T 308

Example:

$$\text{Mass verification} = \frac{2422.5 \text{ g} - 2422.3 \text{ g}}{2422.5 \text{ g}} \times 100 = 0.01\%$$

Given:

$$M_{f(T308)} = 2422.5 \text{ g}$$

$$M_{(T30)} = 2422.3 \text{ g}$$

Procedure

1. Nest a sieve, such as a 2.0 mm (No. 10) or 1.18 mm (No. 16), above the 75 μ m (No. 200) sieve.
2. Place the test sample in a container and cover with water. Add a detergent, dispersing agent, or other wetting solution to the water to assure a thorough separation of the material finer than the 75 μ m (No. 200) sieve from the coarser particles. There should be enough wetting agent to produce a small amount of suds when the sample is agitated. Excessive suds may overflow the sieves and carry material away with them.
3. Agitate vigorously to ensure complete separation of the material finer than 75 μ m (No. 200) from coarser particles and bring the fine material into suspension above the coarser material. Avoid degradation of the sample when using a mechanical washing device. Maximum agitation is 10 min.

Note 1: When mechanical washing equipment is used, the introduction of water, agitating, and decanting may be a continuous operation. Use care not to overflow or overload the 75 μ m (No. 200) sieve.

4. Immediately pour the wash water containing the suspended material over the nested sieves; be careful not to pour out the coarser particles or over fill the 75 μ m (No. 200) sieve.
5. Add water to cover material remaining in the container, agitate, and repeat Step 4. Continue until the wash water is reasonably clear.

6. Remove the upper sieve, return material retained to the washed sample.
7. Rinse the material retained on the 75 μm (No. 200) sieve until water passing through the sieve is reasonably clear and detergent or dispersing agent is removed.
8. Return all material retained on the 75 μm (No. 200) sieve to the washed sample by rinsing into the washed sample.
9. Dry the washed test sample to constant mass according to the FOP for AASHTO T 255. Cool to room temperature. Determine and record the “dry mass after washing.”
10. Select sieves required by the specification and those necessary to avoid overloading. With a pan on bottom, nest the sieves increasing in size starting with the 75 μm (No. 200).
11. Place the test sample, or a portion of the test sample, on the top sieve. Place sieves in mechanical shaker and shake for the minimum time determined to provide complete separation for the sieve shaker being used (approximately 10 minutes, the time determined by Annex A).

Note 2: Excessive shaking (more than 10 minutes) may result in degradation of the sample.

12. Determine and record the individual or cumulative mass retained for each sieve including the pan. Ensure that all material trapped in full openings of the sieves are removed and included in the mass retained.

Note 3: For sieves 4.75 mm (No. 4) and larger, check material trapped in less than a full opening by sieving over a full opening. Use coarse wire brushes to clean the 600 μm (No. 30) and larger sieves, and soft bristle brushes for smaller sieves.

13. Perform the *Check Sum* calculation – Verify the *total mass after sieving* of material agrees with the *dry mass after washing* within 0.2 percent. Do not use test results for acceptance if the *Check Sum* result is greater than 0.2 percent.
14. Calculate the total percentages passing, and the individual or cumulative percentages retained, to the nearest 0.1 percent by dividing the individual sieve masses or cumulative sieve masses by the total mass of the initial dry sample.
15. Apply the Aggregate Correction Factor (ACF) to the calculated percent passing, as required in the FOP for AASHTO T 308 “Correction Factor,” to obtain the reported percent passing.
16. Report total percent passing to 1 percent except report the 75 μm (No. 200) sieve to 0.1 percent.

Calculations**Check Sum**

$$check\ sum = \frac{dry\ mass\ after\ washing - total\ mass\ after\ sieving}{dry\ mass\ after\ washing} \times 100$$

Percent Retained**Individual**

$$IPR = \frac{IMR}{M_{T30}} \times 100$$

Cumulative

$$CPR = \frac{CMR}{M_{T30}} \times 100$$

Where:

IPR	=	Individual Percent Retained
CPR	=	Cumulative Percent Retained
M_{T30}	=	Total dry sample mass before washing
IMR	=	Individual Mass Retained
CMR	=	Cumulative Mass Retained

Percent Passing**Individual**

$$PP = PCP - IPR$$

Cumulative

$$PP = 100 - CPR$$

Where:

PP = Calculated Percent Passing

PCP = Previous Calculated Percent Passing

Reported Percent Passing

$$RPP = PP + ACF$$

Where:

RPP = Reported Percent Passing

ACF = Aggregate Correction Factor (if applicable)

ExampleDry mass of total sample, before washing (M_{T30}): 2422.3 gDry mass of sample, after washing out the 75 μm (No. 200) minus: 2296.2 gAmount of 75 μm (No. 200) minus washed out (2422.3 g – 2296.2g): 126.1 g**Check sum**

$$check\ sum = \frac{2296.2\ g - 2295.3\ g}{2296.2\ g} \times 100 = 0.04\%$$

This is less than 0.2 percent therefore the results can be used for acceptance purposes.

Percent Retained for the 75 µm (No. 200) sieve

$$IPR = \frac{63.5 \text{ g}}{2422.3 \text{ g}} \times 100 = 2.6\%$$

or

$$CPR = \frac{2289.6 \text{ g}}{2422.3 \text{ g}} \times 100 = 94.5\%$$

Percent Passing using IPR and PCP for the 75 µm (No. 200) sieve

$$PP = 8.1\% - 2.6\% = 5.5\%$$

Percent Passing using CPR for the 75 µm (No. 200) sieve

$$PP = 100.0\% - 94.5\% = 5.5\%$$

Reported Percent Passing

$$RPP = 5.5\% = (-0.6\%) = 4.9\%$$

**Individual
Gradation on All Sieves**

Sieve Size mm (in.)	Individual Mass Retained g (IMR)	Determine IPR Divide IMR by <i>M</i> and multiply by 100	Individual Percent Retained (IPR)	Determine PP by subtracting IPR from Previous PP	Percent Passing (PP)	Agg. Corr. Factor from T 308 (ACF)	Reported Percent Passing*
19.0 (3/4)	0		0		100.0		100
12.5 (1/2)	346.9	$\frac{346.9}{2422.3} \times 100 =$	14.3	$100.0 - 14.3 =$	85.7		86
9.5 (3/8)	207.8	$\frac{207.8}{2422.3} \times 100 =$	8.6	$85.7 - 8.6 =$	77.1		77
4.75 (No. 4)	625.4	$\frac{625.4}{2422.3} \times 100 =$	25.8	$77.1 - 25.8 =$	51.3		51
2.36 (No. 8)	416.2	$\frac{416.2}{2422.3} \times 100 =$	17.2	$51.3 - 17.2 =$	34.1		34
1.18 (No. 16)	274.2	$\frac{274.2}{2422.3} \times 100 =$	11.3	$34.1 - 11.3 =$	22.8		23
0.600 (No. 30)	152.1	$\frac{152.1}{2422.3} \times 100 =$	6.3	$22.8 - 6.3 =$	16.5		17
0.300 (No. 50)	107.1	$\frac{107.1}{2422.3} \times 100 =$	4.4	$16.5 - 4.4 =$	12.1		12
0.150 (No. 100)	96.4	$\frac{96.4}{2422.3} \times 100 =$	4.0	$12.1 - 4.0 =$	8.1		8
0.075 (No. 200)	63.5	$\frac{63.5}{2422.3} \times 100 =$	2.6	$8.1 - 2.6 =$	5.5	-0.6 (5.5 - 0.6 =)	4.9
minus 75 µm (No. 200) in the pan	5.7						
Total mass after sieving = sum of sieves + mass in the pan = 2295.3 g							
Dry mass of total sample, before washing (M _{T30}): 2422.3g							

* Report total percent passing to 1 percent except report the 75 µm (No. 200) sieve to 0.1 percent.

**Cumulative
Gradation on All Sieves**

Sieve Size mm (in.)	Cumulative Mass Retained g (CMR)	Determine CPR Divide CMR by M and multiply by 100	Cumulative Percent Retained (CPR)	Determine PP by subtracting CPR from 100.0	Percent Passing (PP)	Agg. Corr. Factor from T 308 (ACF)	Reported Percent Passing*
19.0 (3/4)	0		0.0		100.0		100
12.5 (1/2)	346.9	$\frac{346.9}{2422.3} \times 100 =$	14.3	$100.0 - 14.3 =$	85.7		86
9.5 (3/8)	554.7	$\frac{554.7}{2422.3} \times 100 =$	22.9	$100.0 - 22.9 =$	77.1		77
4.75 (No. 4)	1180.1	$\frac{1180.1}{2422.3} \times 100 =$	48.7	$100.0 - 48.7 =$	51.3		51
2.36 (No. 8)	1596.3	$\frac{1596.3}{2422.3} \times 100 =$	65.9	$100.0 - 65.9 =$	34.1		34
1.18 (No. 16)	1870.5	$\frac{1870.5}{2422.3} \times 100 =$	77.2	$100.0 - 77.2 =$	22.8		23
0.600 (No. 30)	2022.6	$\frac{2022.6}{2422.3} \times 100 =$	83.5	$100.0 - 83.5 =$	16.5		17
0.300 (No. 50)	2129.7	$\frac{2129.7}{2422.3} \times 100 =$	87.9	$100.0 - 87.9 =$	12.1		12
0.150 (No. 100)	2226.1	$\frac{2226.1}{2422.3} \times 100 =$	91.9	$100.0 - 91.9 =$	8.1		8
0.075 (No. 200)	2289.6	$\frac{2289.6}{2422.3} \times 100 =$	94.5	$100.0 - 94.5 =$	5.5	-0.6 (5.5 - 0.6 =)	4.9
minus 75 μm (No. 200) in the pan	2295.3						
Total mass after sieving = 2295.3 g							
Dry mass of total sample, before washing (M _{T30}): 2422.3g							

* Report total percent passing to 1 percent except report the 75 μm (No. 200) sieve to 0.1 percent.

Report

- On forms approved by the agency
- Sample ID
- Depending on the agency, this may include:
 - Individual mass retained on each sieve
 - Individual percent retained on each sieve
 - Cumulative mass retained on each sieve
 - Cumulative percent retained on each sieve
 - Aggregate Correction Factor for each sieve from AASHTO T 308
 - Calculated percent passing each sieve to 0.1 percent
- Percent passing to the nearest 1 percent, except 75 μm (No. 200) sieve to the nearest 0.1 percent.

ANNEX A TIME EVALUATION

(Mandatory Information)

The minimum time requirement should be evaluated for each shaker at least annually by the following method:

1. Shake the sample over nested sieves for approximately 10 minutes.
2. Provide a snug-fitting pan and cover for each sieve and hold in a slightly inclined position in one hand.
3. Hand-shake each sieve by striking the side of the sieve sharply and with an upward motion against the heel of the other hand at the rate of about 150 times per minute, turning the sieve about one sixth of a revolution at intervals of about 25 strokes.

If more than 0.5 percent by mass of the total sample before sieving passes any sieve after one minute of continuous hand sieving adjust shaker time and re-check.

In determining sieving time for sieve sizes larger than 4.75 mm (No. 4), limit the material on the sieve to a single layer of particles.

ANNEX B OVERLOAD DETERMINATION

(Mandatory Information)

- For sieves with openings smaller than 4.75 mm (No. 4), the mass retained on any sieve shall not exceed 7 kg/m² (4 g/in²) of sieving surface.
- For sieves with openings 4.75 mm (No. 4) and larger, the mass (in kg) shall not exceed the product of 2.5 x (sieve opening in mm) x (effective sieving area). See Table B1.

Additional sieves may be necessary to keep from overloading the specified sieves. The sample may also be sieved in increments or sieves with a larger surface area.

TABLE B1
Maximum Allowable Mass of Material Retained on a Sieve, g
Nominal Sieve Size, mm (in.)
Exact size is smaller (see AASHTO T 27)

Sieve Size		203 dia	305 dia	305 by 305	350 by 350	372 by 580
mm (in.)		(8)	(12)	(12 × 12)	(14 × 14)	(16 × 24)
		Sieving Area m ²				
		0.0285	0.0670	0.0929	0.1225	0.2158
90	(3 1/2)	*	15,100	20,900	27,600	48,500
75	(3)	*	12,600	17,400	23,000	40,500
63	(2 1/2)	*	10,600	14,600	19,300	34,000
50	(2)	3600	8400	11,600	15,300	27,000
37.5	(1 1/2)	2700	6300	8700	11,500	20,200
25.0	(1)	1800	4200	5800	7700	13,500
19.0	(3/4)	1400	3200	4400	5800	10,200
16.0	(5/8)	1100	2700	3700	4900	8600
12.5	(1/2)	890	2100	2900	3800	6700
9.5	(3/8)	670	1600	2200	2900	5100
6.3	(1/4)	440	1100	1500	1900	3400
4.75	(No. 4)	330	800	1100	1500	2600
-4.75	(-No. 4)	200	470	650	860	1510

Specific Gravity and Absorption of Fine Aggregate

AASHTO Designation: T 84-13

ASTM Designation: C 128-07a

AASHTO TEST METHODS CANNOT BE INCLUDED ON ODOT'S WEBSITE DUE TO COPYRIGHT INFRINGEMENT.

TO GET COPIES OF THE TEST METHODS, YOU MAY ORDER A HARD COPY OF ODOT'S **MANUAL OF FIELD TEST PROCEDURES** OR YOU MAY ORDER THE LATEST **STANDARD SPECIFICATIONS FOR TRANSPORTATION MATERIALS AND METHODS OF SAMPLING AND TESTING** FROM AASHTO.

To order ODOT's *Manual of Field Test Procedures*, use the following web address:

<https://www.oregon.gov/ODOT/Forms/2ODOT/7345110.pdf>

To order AASHTO's *Standard Specifications for Transportation Materials and Methods of Sampling and Testing*, visit the [AASHTO Store website](#).

SPECIFIC GRAVITY AND ABSORPTION OF COARSE AGGREGATE FOP FOR AASHTO T 85

Scope

This procedure covers the determination of specific gravity and absorption of coarse aggregate in accordance with AASHTO T 85-14. Specific gravity may be expressed as bulk specific gravity (G_{sb}), bulk specific gravity, saturated surface dry (G_{sb} SSD), or apparent specific gravity (G_{sa}). G_{sb} and absorption are based on aggregate after soaking in water. This procedure is not intended to be used with lightweight aggregates.

Terminology

Absorption – the increase in the mass of aggregate due to water being absorbed into the pores of the material, but not including water adhering to the outside surface of the particles, expressed as a percentage of the dry mass. The aggregate is considered “dry” when it has been maintained at a temperature of $110 \pm 5^{\circ}\text{C}$ ($230 \pm 9^{\circ}\text{F}$) for sufficient time to remove all uncombined water.

Saturated Surface Dry (SSD) – condition of an aggregate particle when the permeable voids are filled with water, but no water is present on exposed surfaces.

Specific Gravity – the ratio of the mass, in air, of a volume of a material to the mass of the same volume of gas-free distilled water at a stated temperature.

Apparent Specific Gravity (G_{sa})– the ratio of the mass, in air, of a volume of the impermeable portion of aggregate to the mass of an equal volume of gas-free distilled water at a stated temperature.

Bulk Specific Gravity (G_{sb})– the ratio of the mass, in air, of a volume of aggregate (including the permeable and impermeable voids in the particles, but not including the voids between particles) to the mass of an equal volume of gas-free distilled water at a stated temperature.

Bulk Specific Gravity (SSD) (G_{sb} SSD) – the ratio of the mass, in air, of a volume of aggregate, including the mass of water within the voids filled to the extent achieved by submerging in water for 15 to 19 hours (but not including the voids between particles), to the mass of an equal volume of gas-free distilled water at a stated temperature.

Apparatus

- Balance or scale: with a capacity of 5 kg, sensitive to 0.1 g. Meeting the requirements of AASHTO M 231.
- Sample container: a wire basket of 3.35 mm (No. 6) or smaller mesh, with a capacity of 4 to 7 L (1 to 2 gal) to contain aggregate with a nominal maximum size of 37.5 mm (1 1/2 in.) or smaller; or a larger basket for larger aggregates, or both.
- Water tank: watertight and large enough to completely immerse aggregate and basket, equipped with an overflow valve to keep water level constant.

- Suspension apparatus: wire used to suspend apparatus shall be of the smallest practical diameter.
- Sieves: 4.75 mm (No. 4) or other sizes as needed, meeting the requirements of FOP for AASHTO T 27/T 11.
- Large absorbent towel

Sample Preparation

1. Obtain the sample in accordance with the FOP for AASHTO R 90 (see Note 1).
2. Mix the sample thoroughly and reduce it to the approximate sample size required by Table 1 in accordance with the FOP for AASHTO R 76.
3. Reject all material passing the appropriate sieve by dry sieving.
4. Thoroughly wash sample to remove dust or other coatings from the surface.
5. Dry the test sample to constant mass according to the FOP for AASHTO T 255/T 265 at a temperature of 110 ±5°C (230 ±9°F) and cool in air at room temperature for 1 to 3 hours.

Note 1: Where the absorption and specific gravity values are to be used in proportioning concrete mixtures in which the aggregates will be in their naturally moist condition, the requirement for initial drying to constant mass may be eliminated, and, if the surfaces of the particles in the sample have been kept continuously wet until test, the 15-to-19 hour soaking may also be eliminated.

6. Re-screen the sample over the appropriate sieve. Reject all material passing that sieve.
7. The sample shall meet or exceed the minimum mass given in Table 1.

Note 2: If this procedure is used only to determine the G_{sb} of oversized material for the FOP for AASHTO T 99 / T 180, the material can be rejected over the appropriate sieve. For T 99 / T 180 Methods A and B, use the 4.75 mm (No. 4) sieve; T 99 / T 180 Methods C and D use the 19 mm (3/4 in).

Table 1

Nominal Maximum Size* mm (in.)	Minimum Mass of Test Sample, g (lb)
12.5 (1/2) or less	2000 (4.4)
19.0 (3/4)	3000 (6.6)
25.0 (1)	4000 (8.8)
37.5 (1 1/2)	5000 (11)
50 (2)	8000 (18)
63 (2 1/2)	12,000 (26)
75 (3)	18,000 (40)

* One sieve larger than the first sieve to retain more than 10 percent of the material using an agency specified set of sieves based on cumulative percent retained. Where large gaps in specification sieves exist, intermediate sieve(s) may be inserted to determine nominal maximum size.

Procedure

1. Immerse the aggregate in water at room temperature for a period of 15 to 19 hours.

Note 3: When testing coarse aggregate of large nominal maximum size requiring large test samples, it may be more convenient to perform the test on two or more subsamples, and then combine the values obtained.

2. Place the empty basket into the water bath and attach to the balance. Inspect the immersion tank to ensure the water level is at the overflow outlet height. Tare the balance with the empty basket attached in the water bath.
3. Remove the test sample from the water and roll it in a large absorbent cloth until all visible films of water are removed. Wipe the larger particles individually. If the test sample dries past the SSD condition, immerse in water for 30 min, and then resume the process of surface-drying.

Note 4: A moving stream of air may be used to assist in the drying operation but take care to avoid evaporation of water from aggregate pores.

4. Determine the SSD mass of the sample, and record this and all subsequent masses to the nearest 0.1 g or 0.1 percent of the sample mass, whichever is greater. Designate this mass as "B."
5. Immediately place the SSD test sample in the sample container and weigh it in water maintained at $23.0 \pm 1.7^{\circ}\text{C}$ ($73.4 \pm 3^{\circ}\text{F}$). Shake the container to release entrapped air before recording the weight. Re-inspect the immersion tank to ensure the water level is at the overflow outlet height. Designate this submerged weight as "C."

Note 5: The container should be immersed to a depth sufficient to cover it and the test sample during mass determination. Wire suspending the container should be of the smallest practical size to minimize any possible effects of a variable immersed length.

6. Remove the sample from the basket. Ensure all material has been removed. Place in a container of known mass.
7. Dry the test sample to constant mass according to the FOP for AASHTO T 255 / T 265 at $110 \pm 5^{\circ}\text{C}$ ($230 \pm 9^{\circ}\text{F}$) and cool in air at room temperature for 1 to 3 hours.
8. Determine and record the dry mass. Designate this mass as "A."

Calculations

Perform calculations and determine values using the appropriate formula below.

Bulk specific gravity (G_{sb})

$$G_{sb} = \frac{A}{B - C}$$

Bulk specific gravity, SSD (G_{sb} SSD)

$$G_{sb}SSD = \frac{B}{B - C}$$

Apparent specific gravity (G_{sa})

$$G_{sa} = \frac{A}{A - C}$$

Absorption

$$\text{Absorption} = \frac{B - A}{A} \times 100$$

Where:

- A = oven dry mass, g
- B = SSD mass, g
- C = weight in water, g

Sample Calculations

Sample	A	B	C	B - C	A - C	B - A
1	2030.9	2044.9	1304.3	740.6	726.6	14.0
2	1820.0	1832.5	1168.1	664.4	651.9	12.5
3	2035.2	2049.4	1303.9	745.5	731.3	14.2

Sample	G _{sb}	G _{sb} SSD	G _{sa}	Absorption
1	2.742	2.761	2.795	0.7
2	2.739	2.758	2.792	0.7
3	2.730	2.749	2.783	0.7

These calculations demonstrate the relationship between G_{sb}, G_{sb} SSD, and G_{sa}. G_{sb} is always lowest since the volume includes voids permeable to water. G_{sb} SSD is always intermediate. G_{sa} is always highest since the volume does not include voids permeable to water. When running this test, check to make sure the values calculated make sense in relation to one another.

Report

- On forms approved by the agency
- Sample ID
- Specific gravity values to the nearest 0.001
- Absorption to the nearest 0.1 percent

EMBANKMENT AND BASE
IN-PLACE DENSITY

WAQTC

FOP AASHTO T 85 (20)

Observe the following for Base Aggregate applications:

- **Use T 99 Method A and perform the Coarse Particle Correction according to ODOT TM 223. This Process shall be used for Dense Graded Base Aggregate Separated Stockpile sizes of 1" – 0 and smaller. Dense Graded Base Aggregate with Separated Stockpile sizes larger than 1" – 0 and Open graded Base Aggregates are non-density testable and should be evaluated according to the appropriate specifications contained in the project contract documents.**
- **Measures may be taken to reduce or eliminate seepage of moisture from between the mold and the base plate which do not affect the mold's volume.**
- **Moisture content of individual points will be determined using the entire molded sample.**

Annex A Section

Earthwork and other graded Aggregates, except Base Aggregate Applications, use the following Oversize Particle Correction guidelines:

- **Less than 10% plus No. 4 (Method A), no coarse particle correction is required.**
- **10%-- 40% plus No. 4 (Method A), a coarse particle correction is required.**
- **Over 40% plus No. 4 (Method A), re-screen material and perform T 99 method D.**
- **Less than 10% plus 3/4 in. (Method D), no coarse particle correction is required.**
- **10%-- 30% plus 3/4 in. (Method D), a coarse particle correction is required.**
- **Over 30% plus 3/4 in. (Method D), the material is non-density testable and should be evaluated according to the earthwork or appropriate aggregate specifications contained in the project contract documents.**
- ***Percentage of coarse particles can be determined in the wet state.***

Observe the following for other Graded Aggregates:

- **If during crushing operations process control data is available for the No. 4 and/or 3/4 in. screen use the average values to compute the coarse particle correction.**



Oregon

Kate Brown, Governor

Department of Transportation

Construction Section
800 Airport Road SE
Salem, OR 97301-4792
Phone: (503) 986-3000
Fax: (503) 986-3096

October 31, 2018

To: All Holders of the Manual of Field Test Procedures

Section: **Test Procedure AASHTO T 99 and T 180**

The Oregon Department of Transportation has specified method(s) for this Test Procedure. Please observe the following for our projects:

- **Methods B & C are not allowed on ODOT contracts.**
- **Use T 99 Methods A or D for earthwork applications and other graded materials, except Base Aggregate, based on the following criteria:**
 1. **The soil or soil/aggregate mixture will first be analyzed according to Method A. If the amount of material retained on the No. 4 screen exceeds 40% then use Method D.**
 2. **If the amount of material retained on the 3/4" screen exceeds 30% then the material is non-density testable and should be evaluated according to the appropriate specifications contained in the project contract documents.**
- **Under Section Apparatus, Mold, determination of the mold volume is not required according to Annex B, if the wet density is computed using the mold volume based on Table 2.**
- **Under Section Apparatus, Balances or Scales for the standard or modified proctor, change the scale sensitivity to 5 g or better.**
- **Under procedure, step 15; delete the second and third sentence. Add the following: *(Note: For proper curve development a minimum of 3 points representing the dry side and 2 points representing the wet side of the curve is considered best practice).***
- **Under the Calculations Section, wet density may be computed using the molds volume in Table 2 or a "Mold Factor" can be used as a multiplier based on the following: Mass determination in lbs., 4" diameter mold (30) and in grams (0.06614) and 6" diameter mold in lbs. (13.33) and in grams (0.02939).**

(See Next Page)

**MOISTURE-DENSITY RELATIONS OF SOILS:
USING A 2.5 KG (5.5 LB) RAMMER AND A 305 MM (12 IN.) DROP**

**FOP FOR AASHTO T 99
USING A 4.54 KG (10 LB) RAMMER AND A 457 MM (18 IN.) DROP
FOP FOR AASHTO T 180**

Scope

This procedure covers the determination of the moisture-density relations of soils and soil-aggregate mixtures in accordance with two similar test methods:

- AASHTO T 99-19: Methods A, B, C, and D
- AASHTO T 180-20: Methods A, B, C, and D

This test method applies to soil mixtures having 40 percent or less retained on the 4.75 mm (No. 4) sieve for methods A or B, or, 30 percent or less retained on the 19 mm ($\frac{3}{4}$ in.) with methods C or D. The retained material is defined as oversize (coarse) material. If no minimum percentage is specified, 5 percent will be used. Samples that contain oversize (coarse) material that meet percent retained criteria should be corrected by using *Annex A, Correction of Maximum Dry Density and Optimum Moisture for Oversized Particles*. Samples of soil or soil-aggregate mixture are prepared at several moisture contents and compacted into molds of specified size, using manual or mechanical rammers that deliver a specified quantity of compactive energy. The moist masses of the compacted samples are multiplied by the appropriate factor to determine wet density values. Moisture contents of the compacted samples are determined and used to obtain the dry density values of the same samples. Maximum dry density and optimum moisture content for the soil or soil-aggregate mixture is determined by plotting the relationship between dry density and moisture content.

Apparatus

- Mold – Cylindrical mold made of metal with the dimensions shown in Table 1 or Table 2. If permitted by the agency, the mold may be of the “split” type, consisting of two half-round sections, which can be securely locked in place to form a cylinder. Determine the mold volume according to *Annex B, Standardization of the Mold*.
- Mold assembly – Mold, base plate, and a detachable collar.
- Rammer – Manually or mechanically operated rammers as detailed in Table 1 or Table 2. A manually operated rammer shall be equipped with a guide sleeve to control the path and height of drop. The guide sleeve shall have at least four vent holes no smaller than 9.5 mm ($\frac{3}{8}$ in.) in diameter, spaced approximately 90 degrees apart and approximately 19 mm ($\frac{3}{4}$ in.) from each end. A mechanically operated rammer will uniformly distribute blows over the sample and will be calibrated with several soil types, and be adjusted, if necessary, to give the same moisture-density results as with the manually operated rammer. For additional information concerning calibration, see the FOP for AASHTO T 99 and T 180.

- Sample extruder – A jack, lever frame, or other device for extruding compacted specimens from the mold quickly and with little disturbance.
- Balance(s) or scale(s) of the capacity and sensitivity required for the procedure used by the agency.
 - A balance or scale with a capacity of 11.5 kg (25 lb) and a sensitivity of 1 g for obtaining the sample, meeting the requirements of AASHTO M 231, Class G 5.
 - A balance or scale with a capacity of 2 kg and a sensitivity of 0.1 g is used for moisture content determinations done under both procedures, meeting the requirements of AASHTO M 231, Class G 2.
- Drying apparatus – A thermostatically controlled drying oven, capable of maintaining a temperature of $110 \pm 5^{\circ}\text{C}$ ($230 \pm 9^{\circ}\text{F}$) for drying moisture content samples in accordance with the FOP for AASHTO T 255/T 265.
- Straightedge – A steel straightedge at least 250 mm (10 in.) long, with one beveled edge and at least one surface plane within 0.1 percent of its length, used for final trimming.
- Sieve(s) – 4.75 mm (No. 4) and/or 19.0 mm (3/4 in.), meeting the requirements of FOP for AASHTO T 27/T 11.
- Mixing tools – Miscellaneous tools such as a mixing pan, spoon, trowel, spatula, etc., or a suitable mechanical device, for mixing the sample with water.
- Containers with close-fitting lids to prevent gain or loss of moisture in the sample.

Table 1
Comparison of Apparatus, Sample, and Procedure – Metric

	T 99	T 180
Mold Volume, m ³	Methods A, C: 0.000943 ±0.000014	Methods A, C: 0.000943 ±0.000014
	Methods B, D: 0.002124 ±0.000025	Methods B, D: 0.002124 ±0.000025
Mold Diameter, mm	Methods A, C: 101.60 ±0.40	Methods A, C: 101.60 ±0.4
	Methods B, D: 152.40 ±0.70	Methods B, D: 152.40 ±0.70
Mold Height, mm	116.40 ±0.50	116.40 ±0.50
Detachable Collar Height, mm	50.80 ±0.64	50.80 ±0.64
Rammer Diameter, mm	50.80 ±0.25	50.80 ±0.25
Rammer Mass, kg	2.495 ±0.009	4.536 ±0.009
Rammer Drop, mm	305	457
Layers	3	5
Blows per Layer	Methods A, C: 25	Methods A, C: 25
	Methods B, D: 56	Methods B, D: 56
Material Size, mm	Methods A, B: 4.75 minus	Methods A, B: 4.75 minus
	Methods C, D: 19.0 minus	Methods C, D: 19.0 minus
Test Sample Size, kg	Method A: 3 Method C: 5 (1)	Method B: 7 Method D: 11(1)
Energy, kN-m/m ³	592	2,693

(1) This may not be a large enough sample depending on your nominal maximum size for moisture content samples.

Table 2
Comparison of Apparatus, Sample, and Procedure – English

	T 99	T 180
Mold Volume, ft ³	Methods A, C: 0.0333 ±0.0005	Methods A, C: 0.0333 ±0.0005
	Methods B, D: 0.07500 ±0.0009	Methods B, D: 0.07500 ±0.0009
Mold Diameter, in.	Methods A, C: 4.000 ±0.016	Methods A, C: 4.000 ±0.016
	Methods B, D: 6.000 ±0.026	Methods B, D: 6.000 ±0.026
Mold Height, in.	4.584 ±0.018	4.584 ±0.018
Detachable Collar Height, in.	2.000 ±0.025	2.000 ±0.025
Rammer Diameter, in.	2.000 ±0.025	2.000 ±0.025
Rammer Mass, lb	5.5 ±0.02	10 ±0.02
Rammer Drop, in.	12	18
Layers	3	5
Blows per Layer	Methods A, C: 25	Methods A, C: 25
	Methods B, D: 56	Methods B, D: 56
Material Size, in.	Methods A, B: No. 4 minus	Methods A, B: No.4 minus
	Methods C, D: 3/4 minus	Methods C, D: 3/4 minus
Test Sample Size, lb	Method A: 7 Method C: 12 ₍₁₎	Method B: 16 Method D: 25 ₍₁₎
Energy, lb-ft/ft ³	12,375	56,250

(1) This may not be a large enough sample depending on your nominal maximum size for moisture content samples.

Sample

If the sample is damp, dry it until it becomes friable under a trowel. Drying may be in air or by use of a drying apparatus maintained at a temperature not exceeding 60°C (140°F). Thoroughly break up aggregations in a manner that avoids reducing the natural size of individual particles.

Obtain a representative test sample of the mass required by the agency by passing the material through the sieve required by the agency. See Table 1 or Table 2 for test sample mass and material size requirements.

In instances where the material is prone to degradation, i.e., granular material, a compaction sample with differing moisture contents should be prepared for each point.

If the sample is plastic (clay types), it should stand for a minimum of 12 hours after the addition of water to allow the moisture to be absorbed. In this case, several samples at different moisture contents should be prepared, put in sealed containers, and tested the next day.

Note 1: Both T 99 and T 180 have four methods (A, B, C, D) that require different masses and employ different sieves.

Procedure

During compaction, rest the mold firmly on a dense, uniform, rigid, and stable foundation, or base. This base shall remain stationary during the compaction process.

1. Determine the mass of the clean, dry mold. Include the base plate but exclude the extension collar. Record the mass to the nearest 1 g (0.005 lb).
2. Thoroughly mix the selected representative sample with sufficient water to dampen it to approximately 4 to 8 percentage points below optimum moisture content. For many materials, this condition can be identified by forming a cast by hand.
 - a. Prepare individual samples of plastic or degradable material, increasing moisture contents 1 to 2 percent for each point.
 - b. Allow samples of plastic soil to stand for 12 hrs.
3. Form a specimen by compacting the prepared soil in the mold assembly in approximately equal layers. For each layer:
 - a. Spread the loose material uniformly in the mold.

Note 2: It is recommended to cover the remaining material with a non-absorbent sheet or damp cloth to minimize loss of moisture.

- b. Lightly tamp the loose material with the manual rammer or other similar device, this establishes a firm surface.
 - c. Compact each layer with uniformly distributed blows from the rammer. See Table 1 for mold size, number of layers, number of blows, and rammer specification for the various test methods. Use the method specified by the agency.
 - d. Trim down material that has not been compacted and remains adjacent to the walls of the mold and extends above the compacted surface.

4. Remove the extension collar. Avoid shearing off the sample below the top of the mold. The material compacted in the mold should not be over 6 mm (¼ in.) above the top of the mold once the collar has been removed.
5. Trim the compacted soil even with the top of the mold with the beveled side of the straightedge.
6. Clean soil from exterior of the mold and base plate.
7. Determine and record the mass of the mold, base plate, and wet soil to the nearest 1 g (0.005 lb) or better.
8. Determine and record the wet mass (M_w) of the sample by subtracting the mass in Step 1 from the mass in Step 7.
9. Calculate the wet density (ρ_w), in kg/m^3 (lb/ft^3), by dividing the wet mass by the measured volume (V_m).
10. Extrude the material from the mold. For soils and soil-aggregate mixtures, slice vertically through the center and take a representative moisture content sample from one of the cut faces, ensuring that all layers are represented. For granular materials, a vertical face will not exist. Take a representative sample. This sample must meet the sample size requirements of the test method used to determine moisture content.



Extruded material

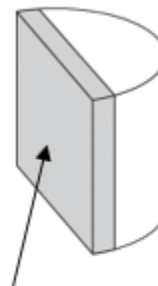

**Representative moisture
content sample**

Note 3: When developing a curve for free-draining soils such as uniform sands and gravels, where seepage occurs at the bottom of the mold and base plate, taking a representative moisture content from the mixing bowl may be preferred in order to determine the amount of moisture available for compaction.

11. Determine and record the moisture content of the sample in accordance with the FOP for AASHTO T 255 / T 265.
12. If the material is degradable or plastic, return to Step 3 using a prepared individual sample. If not, continue with Steps 13 through 15.
13. Thoroughly break up the remaining portion of the molded specimen until it will again pass through the sieve, as judged by eye, and add to the remaining portion of the sample being tested.

14. Add sufficient water to increase the moisture content of the remaining soil by 1 to 2 percentage points and repeat steps 3 through 11.
15. Continue determinations until there is either a decrease or no change in the wet mass. There will be a minimum of three points on the dry side of the curve and two points on the wet side. For non-cohesive, drainable soils, one point on the wet side is sufficient.

Calculations

Wet Density

$$\rho_w = \frac{M_w}{V_m}$$

Where:

- ρ_w = wet density, kg/m³ (lb/ft³)
- M_w = wet mass
- V_m = volume of the mold, Annex B

Dry Density

$$\rho_d = \left(\frac{D_w}{w + 100} \right) \times 100 \quad \text{or} \quad \rho_d = \frac{D_w}{\left(\frac{w}{100} \right) + 1}$$

Where:

- ρ_d = dry density, kg/m³ (lb/ft³)
- w = moisture content, as a percentage

Example for 4-inch mold, Methods A or C

- Wet mass, M_w = 1.928 kg (4.25 lb)
- Moisture content, w = 11.3%
- Measured volume of the mold, V_m = 0.000946 m³ (0.0334 ft³)

Wet Density

$$\rho_w = \frac{1.928 \text{ kg}}{0.000946 \text{ m}^3} = 2038 \text{ kg/m}^3 \quad \rho_w = \frac{4.25 \text{ lb}}{0.0334 \text{ ft}^3} = 127.2 \text{ lb/ft}^3$$

Dry Density

$$\rho_d = \left(\frac{2038 \text{ kg/m}^3}{11.3 + 100} \right) \times 100 = 1831 \text{ kg/m}^3 \quad \rho_d = \left(\frac{127.2 \text{ lb/ft}^3}{11.3 + 100} \right) \times 100 = 114.3 \text{ lb/ft}^3$$

Or

$$\rho_d = \left(\frac{2038 \text{ kg/m}^3}{\frac{11.3}{100} + 1} \right) = 1831 \text{ kg/m}^3 \quad \rho_d = \left(\frac{127.2 \text{ lb/ft}^3}{\frac{11.3}{100} + 1} \right) = 114.3 \text{ lb/ft}^3$$

Moisture-Density Curve Development

When dry density is plotted on the vertical axis versus moisture content on the horizontal axis and the points are connected with a smooth line, a moisture-density curve is developed. The coordinates of the peak of the curve are the maximum dry density, or just “maximum density,” and the “optimum moisture content” of the soil.

Example

Given the following dry density and corresponding moisture content values develop a moisture-density relations curve and determine maximum dry density and optimum moisture content.

Dry Density		Moisture Content, %
kg/m ³	lb/ft ³	
1831	114.3	11.3
1853	115.7	12.1
1873	116.9	12.8
1869	116.7	13.6
1857	115.9	14.2

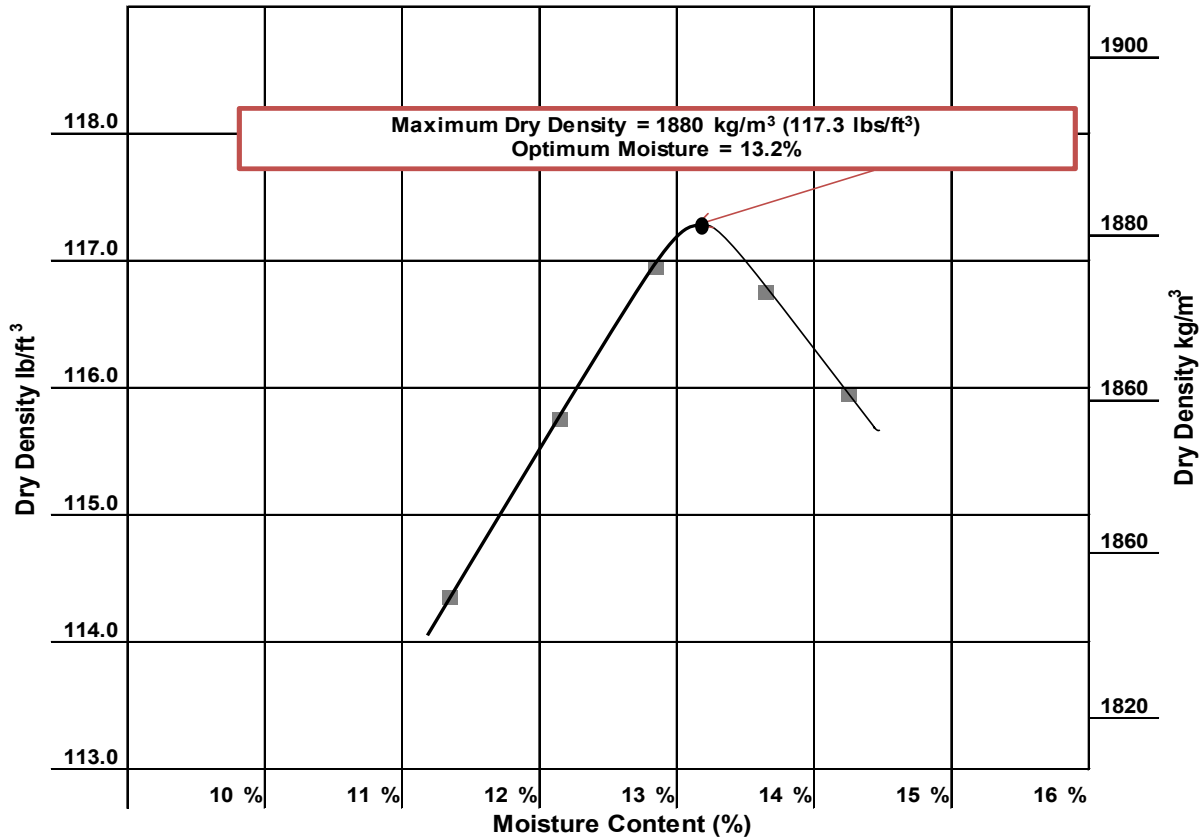

In this case, the curve has its peak at:

Maximum dry density = 1880 kg/m³ (117.3 lb/ft³)

Optimum moisture content = 13.2%

Note that both values are approximate since they are based on sketching the curve to fit the points.

Report

- Results on forms approved by the agency
- Sample ID
- Maximum dry density to the nearest 1 kg/m³ (0.1 lb/ft³)
- Optimum moisture content to the nearest 0.1 percent

ANNEX A

CORRECTION OF MAXIMUM DRY DENSITY AND OPTIMUM MOISTURE FOR OVERSIZED PARTICLES

(Mandatory Information)

This section corrects the maximum dry density and moisture content of the material retained on the 4.75 mm (No. 4) sieve, Methods A and B; or the material retained on the 19 mm (¾ in.) sieve, Methods C and D. The maximum dry density, corrected for oversized particles and total moisture content, are compared with the field-dry density and field moisture content.

This correction can be applied to the sample on which the maximum dry density is performed. A correction may not be practical for soils with only a small percentage of oversize material. The agency shall specify a minimum percentage below which the method is not needed. If not specified, this method applies when more than 5 percent by weight of oversize particles is present.

Bulk specific gravity (G_{sb}) of the oversized particles is required to determine the corrected maximum dry density. Use the bulk specific gravity as determined using the FOP for AASHTO T 85 in the calculations. For construction activities, an agency established value or specific gravity of 2.600 may be used.

This correction can also be applied to the sample obtained from the field while performing in-place density.

Procedure

1. Use the sample from this procedure or a sample obtained according to the FOP for AASHTO T 310.
2. Sieve the sample on the 4.75 mm (No. 4) sieve for Methods A and B or the 19 mm (¾ in.) sieve, Methods C and D.
3. Determine the dry mass of the oversized and fine fractions (M_{DC} and M_{DF}) by one of the following:
 - a. Dry the fractions, fine and oversized, in air or by use of a drying apparatus that is maintained at a temperature not exceeding 60°C (140°F).
 - b. Calculate the dry masses using the moisture samples.

To determine the dry mass of the fractions using moisture samples.

1. Determine the moist mass of both fractions, fine (M_{Mf}) and oversized (M_{Mc}):
2. Obtain moisture samples from the fine and oversized material.
3. Determine the moisture content of the fine particles (MC_f) and oversized particles (MC_c) of the material by FOP for AASHTO T 255/T 265 or agency approved method.
4. Calculate the dry mass of the oversize and fine particles.

$$M_D = \frac{M_m}{1 + MC}$$

Where:

M_D = mass of dry material (fine or oversize particles)

M_m = mass of moist material (fine or oversize particles)

MC = moisture content of respective fine or oversized, expressed as a decimal

5. Calculate the percentage of the fine (P_f) and oversized (P_c) particles by dry weight of the total sample as follows: See Note 2.

$$P_f = \frac{100 \times M_{DF}}{M_{DF} + M_{DC}} \quad \frac{100 \times 15.4 \text{ lb}}{15.4 \text{ lbs} + 5.7 \text{ lb}} = 73\% \quad \frac{100 \times 6.985 \text{ kg}}{6.985 \text{ kg} + 2.585 \text{ kg}} = 73\%$$

And

$$P_c = \frac{100 \times M_{DC}}{M_{DF} + M_{DC}} \quad \frac{100 \times 5.7 \text{ lb}}{15.4 \text{ lbs} + 5.7 \text{ lb}} = 27\% \quad \frac{100 \times 2.585 \text{ kg}}{6.985 \text{ kg} + 2.585 \text{ kg}} = 27\%$$

Or for P_c :

$$P_c = 100 - P_f$$

Where:

P_f = percent of fine particles, of sieve used, by weight

P_c = percent of oversize particles, of sieve used, by weight

M_{DF} = mass of dry fine particles

M_{DC} = mass of dry oversize particles

Optimum Moisture Correction Equation

1. Calculate the corrected moisture content as follows:

$$MC_T = \frac{(MC_F \times P_f) + (MC_c \times P_c)}{100} = \frac{(13.2\% \times 73.0\%) + (2.1\% \times 27.0\%)}{100} = 10.2\%$$

MC_T = corrected moisture content of combined fines and oversized particles, expressed as a % moisture

MC_F = moisture content of fine particles, as a % moisture

MC_C = moisture content of oversized particles, as a % moisture

Note 1: Moisture content of oversize material can be assumed to be two (2) percent for most construction applications.

Note 2: In some field applications agencies will allow the percentages of oversize and fine materials to be determined with the materials in the wet state.

Density Correction Equation

2. Calculate the corrected dry density (ρ_d) of the total sample (combined fine and oversized particles) as follows:

$$\rho_d = \frac{100\%}{\left[\left(\frac{P_f}{\rho_f}\right) + \left(\frac{P_c}{k}\right)\right]}$$

Where:

ρ_d = corrected total dry density (combined fine and oversized particles)
kg/m³ (lb/ft³)

ρ_f = dry density of the fine particles kg/m³ (lb/ft³), determined in the lab

P_c = percent of dry oversize particles, of sieve used, by weight.

P_f = percent of dry fine particles, of sieve used, by weight.

k = Metric: 1,000 * Bulk Specific Gravity (G_{sb}) (oven dry basis)
of coarse particles (kg/m³).

k = English: 62.4 * Bulk Specific Gravity (G_{sb}) (oven dry basis)
of coarse particles (lb/ft³)

Note 3: If the specific gravity is known, then this value will be used in the calculation. For most construction activities the specific gravity for aggregate may be assumed to be 2.600.

Calculation

Example

- Metric:

Maximum laboratory dry density (ρ_f):	1880 kg/m ³
Percent coarse particles (P_c):	27%
Percent fine particles (P_f):	73%
Mass per volume coarse particles (k):	(2.697) (1000) = 2697 kg/m ³

$$\rho_d = \frac{100\%}{\left[\left(\frac{P_f}{\rho_f}\right) + \left(\frac{P_c}{k}\right)\right]}$$

$$\rho_d = \frac{100\%}{\left[\left(\frac{73\%}{1880 \text{ kg/m}^3}\right) + \left(\frac{27\%}{2697 \text{ kg/m}^3}\right)\right]}$$

$$\rho_d = \frac{100\%}{[0.03883 \text{ kg/m}^3 + 0.01001 \text{ kg/m}^3]}$$

$$\rho_d = 2047.5 \text{ kg/m}^3 \text{ report } 2048 \text{ kg/m}^3$$

English:

Maximum laboratory dry density (ρ_f): 117.3 lb/ft³

Percent coarse particles (P_c): 27%

Percent fine particles (P_f): 73%

Mass per volume of coarse particles (k): (2.697) (62.4) = 168.3 lb/ft³

$$\rho_d = \frac{100\%}{\left[\left(\frac{P_f}{\rho_f}\right) + \left(\frac{P_c}{k}\right)\right]}$$

$$\rho = \frac{100\%}{\left[\left(\frac{73\%}{117.3 \text{ lb/ft}^3}\right) + \left(\frac{27\%}{168.3 \text{ lb/ft}^3}\right)\right]}$$

$$\rho_d = \frac{100\%}{[0.6223 \text{ lb/ft}^3 + 0.1604 \text{ lb/ft}^3]}$$

$$\rho_d = \frac{100\%}{0.7827 \text{ lb/ft}^3}$$

$$\rho_d = 127.76 \text{ lb/ft}^3 \quad \text{Report } 127.8 \text{ lb/ft}^3$$

Report

- On forms approved by the agency
- Sample ID
- Corrected maximum dry density to the nearest 1 kg/m³ (0.1 lb/ft³)
- Corrected optimum moisture to the nearest 0.1 percent

ANNEX B

STANDARDIZATION OF THE MOLD

(Mandatory Information)

Standardization is a critical step to ensure accurate test results when using this apparatus. Failure to perform the standardization procedure as described herein will produce inaccurate or unreliable test results.

Apparatus

- Mold and base plate
- Balance or scale – Accurate to within 45 g (0.1 lb) or 0.3 percent of the test load, whichever is greater, at any point within the range of use.
- Cover plate – A piece of plate glass, at least 6 mm (1/4 in.) thick and at least 25 mm (1 in.) larger than the diameter of the mold.
- Thermometers – Standardized liquid-in-glass, or electronic digital total immersion type, accurate to 0.5°C (1°F)

Procedure

1. Create a watertight seal between the mold and base plate.
2. Determine and record the mass of the dry sealed mold, base plate, and cover plate.
3. Fill the mold with water at a temperature between 16°C and 29°C (60°F and 85°F) and cover with the cover plate in such a way as to eliminate bubbles and excess water.
4. Wipe the outside of the mold, base plate, and cover plate dry, being careful not to lose any water from the mold.
5. Determine and record the mass of the filled mold, base plate, cover plate, and water.
6. Determine and record the mass of the water in the mold by subtracting the mass in Step 2 from the mass in Step 5.
7. Measure the temperature of the water and determine its density from Table B1, interpolating, as necessary.
8. Calculate the volume of the mold, V_m , by dividing the mass of the water in the mold by the density of the water at the measured temperature.

Calculations

$$V_m = \frac{M}{\rho_{water}}$$

Where:

V_m = volume of the mold

M = mass of water in the mold

ρ_{water} = density of water at the measured temperature

Example

Mass of water in mold = 0.94367 kg (2.0800 lb)

ρ_{water} at 23°C (73.4°F) = 997.54 kg/m³ (62.274 lb/ft³)

$$V_m = \frac{0.94367 \text{ kg}}{997.54 \text{ kg/m}^3} = 0.000946 \text{ m}^3 \quad V_m = \frac{2.0800 \text{ lb}}{62.274 \text{ lb/ft}^3} = 0.0334 \text{ ft}^3$$

Table B1
Unit Mass of Water
15°C to 30°C

°C	(°F)	kg/m ³	(lb/ft ³)	°C	(°F)	kg/m ³	(lb/ft ³)
15	(59.0)	999.10	(62.372)	23	(73.4)	997.54	(62.274)
15.6	(60.0)	999.01	(62.366)	23.9	(75.0)	997.32	(62.261)
16	(60.8)	998.94	(62.361)	24	(75.2)	997.29	(62.259)
17	(62.6)	998.77	(62.350)	25	(77.0)	997.03	(62.243)
18	(64.4)	998.60	(62.340)	26	(78.8)	996.77	(62.227)
18.3	(65.0)	998.54	(62.336)	26.7	(80.0)	996.59	(62.216)
19	(66.2)	998.40	(62.328)	27	(80.6)	996.50	(62.209)
20	(68.0)	998.20	(62.315)	28	(82.4)	996.23	(62.192)
21	(69.8)	997.99	(62.302)	29	(84.2)	995.95	(62.175)
21.1	(70.0)	997.97	(62.301)	29.4	(85.0)	995.83	(62.166)
22	(71.6)	997.77	(62.288)	30	(86.0)	995.65	(62.156)

Report

- Mold ID
- Date Standardized
- Temperature of the water
- Volume, V_m , of the mold to the nearest 0.000001 m^3 (0.0001 ft^3)

SLUMP OF HYDRAULIC CEMENT CONCRETE FOP FOR AASHTO T 119

Scope

This procedure provides instructions for determining the slump of hydraulic cement concrete in accordance with AASHTO T 119-18. It is not applicable to non-plastic and non-cohesive concrete.

Warning—Fresh Hydraulic cementitious mixtures are caustic and may cause chemical burns to skin and tissue upon prolonged exposure.

Apparatus

- Mold: conforming to AASHTO T 119
 - Metal: a metal frustum of a cone provided with foot pieces and handles. The mold must be constructed without a seam. The interior of the mold shall be relatively smooth and free from projections such as protruding rivets. The mold shall be free from dents. A mold that clamps to a rigid nonabsorbent base plate is acceptable provided the clamping arrangement is such that it can be fully released without movement of the mold.
 - Non-metal: see AASHTO T 119, Section 5.1.2.
- Tamping rod: 16 mm (5/8 in.) diameter and 400 mm (16 in.) to 600 mm (24 in.) long, having a hemispherical tip the same diameter as the rod. (Hemispherical means “half a sphere”; the tip is rounded like half of a ball.)
- Scoop: a receptacle of appropriate size so that each representative increment of the concrete sample can be placed in the container without spillage.
- Tape measure or ruler with at least 5 mm or 1/8 in. graduations
- Base: flat, rigid, non-absorbent moistened surface on which to set the slump mold

Procedure

1. Obtain the sample in accordance with the FOP for WAQTC TM 2. If the concrete mixture contains aggregate retained on the 37.5mm (1½ in.) sieve, the aggregate must be removed in accordance with the Wet Sieving portion of the FOP for WAQTC TM 2.

Begin testing within five minutes of obtaining the sample.

2. Dampen the inside of the mold and place it on a dampened, rigid, nonabsorbent surface that is level and firm.
3. Stand on both foot pieces in order to hold the mold firmly in place.
4. Use the scoop to fill the mold 1/3 full by volume, to a depth of approximately 67 mm (2 5/8 in.) by depth.

5. Consolidate the layer with 25 strokes of the tamping rod, using the rounded end. Distribute the strokes evenly over the entire cross section of the concrete.
For this bottom layer, incline the rod slightly and make approximately half the strokes near the perimeter, and then progress with vertical strokes, spiraling toward the center.
6. Use the scoop to fill the mold 2/3 full by volume, to a depth of approximately 155 mm (6 1/8 in.) by depth.
7. Consolidate this layer with 25 strokes of the tamping rod, penetrate approximately 25 mm (1 in.) into the bottom layer. Distribute the strokes evenly.
8. Use the scoop to fill the mold to overflowing.
9. Consolidate this layer with 25 strokes of the tamping rod, penetrate approximately 25 mm (1 in.) into the second layer. Distribute the strokes evenly. If the concrete falls below the top of the mold, stop, add more concrete, and continue rodding for a total of 25 strokes. Keep an excess of concrete above the top of the mold at all times. Distribute strokes evenly as before.
10. Strike off the top surface of concrete with a screeding and rolling motion of the tamping rod.
11. Clean overflow concrete away from the base of the mold.
12. Remove the mold from the concrete by raising it carefully in a vertical direction. Raise the mold 300 mm (12 in.) in 5 ± 2 seconds by a steady upward lift with no lateral or torsional (twisting) motion being imparted to the concrete.
Complete the entire operation from the start of the filling through removal of the mold without interruption within an elapsed time of 2 1/2 minutes. Immediately measure the slump.
13. Invert the slump mold and set it next to the specimen.
14. Lay the tamping rod across the mold so that it is over the test specimen.
15. Measure the distance between the bottom of the rod and the displaced original center of the top of the specimen to the nearest 5 mm (1/4 in.).

Note 1: If a decided falling away or shearing off of concrete from one side or portion of the mass occurs, disregard the test and make a new test on another portion of the sample. If two consecutive tests on a sample of concrete show a falling away or shearing off of a portion of the concrete from the mass of the specimen, the concrete probably lacks the plasticity and cohesiveness necessary for the slump test to be applicable.

16. Discard the tested sample.

Report

- Results on forms approved by the agency
- Sample ID
- Slump to the nearest 5 mm (1/4 in.).



Oregon

John A. Kitzhaber, M.D., Governor

Department of Transportation

Construction Section
800 Airport Road SE
Salem, OR 97301-4792
Phone: (503) 986-3000
Fax: (503) 986-3096

October 1, 2011

To: All Holders of the Manual of Field Test Procedures

Section: **Test Procedure AASHTO T 121**

The Oregon Department of Transportation has specified method(s) for this Test Procedure. Please observe the following for our projects:

- **Under Calculations Section;**
 - **Cement Content – Actual cement content includes all Cemetitious Materials (cm), such as but not limited to; Portland Cement, Fly Ash, Silica Fume, Ground Granulated Blast Furnace Slag and Metakaolin.**
 - **Water Content – ODOT requires liquid additives to be included.**

DENSITY (UNIT WEIGHT), YIELD, AND AIR CONTENT (GRAVIMETRIC) OF CONCRETE FOP FOR AASHTO T 121

Scope

This procedure covers the determination of density, or unit weight, of freshly mixed concrete in accordance with AASHTO T 121-19. It also provides formulas for calculating the volume of concrete produced from a mixture of known quantities of component materials and provides a method for calculating cement content and cementitious material content – the mass of cement or cementitious material per unit volume of concrete. A procedure for calculating water/cement ratio is also covered.

Warning—Fresh Hydraulic cementitious mixtures are caustic and may cause chemical burns to skin and tissue upon prolonged exposure.

Apparatus

- **Measure:** May be the bowl portion of the air meter used for determining air content under the FOP for AASHTO T 152. Otherwise, it shall be a metal cylindrical container meeting the requirements of AASHTO T 121. The capacity and dimensions of the measure shall conform to those specified in Table 1.
- **Balance or scale:** Accurate to within 45 g (0.1 lb) or 0.3 percent of the test load, whichever is greater, at any point within the range of use.
- **Tamping rod:** 16 mm (5/8 in.) diameter and 400 mm (16 in.) to 600 mm (24 in.) long, having a hemispherical tip the same diameter as the rod. (Hemispherical means “half a sphere”; the tip is rounded like half of a ball.)
- **Vibrator:** frequency at least 9000 vibrations per minute (150 Hz), at least 19 to 38 mm (3/4 to 1 1/2 in.) in diameter but not greater than 38 mm (1 1/2 in.), and the length of the shaft shall be at least 75 mm (3 in.) longer than the depth of the section being vibrated.
- **Scoop:** a receptacle of appropriate size so that each representative increment of the concrete sample can be placed in the container without spillage.
- **Strike-off plate:** A flat rectangular metal plate at least 6 mm (1/4 in.) thick or a glass or acrylic plate at least 12 mm (1/2 in.) thick, with a length and width at least 50 mm (2 in.) greater than the diameter of the measure with which it is to be used. The edges of the plate shall be straight and smooth within tolerance of 1.5 mm (1/16 in.).
- **Mallet:** With a rubber or rawhide head having a mass of 0.57 ± 0.23 kg (1.25 \pm 0.5 lb) for use with measures of 0.014 m³ (1/2 ft³) or less, or having a mass of 1.02 ± 0.23 kg (2.25 \pm 0.5 lb) for use with measures of 0.028 m³ (1 ft³).

Table 1
Dimensions of Measures*

Capacity m ³ (ft ³)	Inside Diameter mm (in.)	Inside Height mm (in.)	Minimum Thicknesses mm (in.)		Nominal Maximum Size of Coarse Aggregate*** mm (in.)
			Bottom	Wall	
0.0071	203 ±2.54	213 ±2.54	5.1	3.0	25
(1/4)**	(8.0 ±0.1)	(8.4 ±0.1)	(0.20)	(0.12)	(1)
0.0142	254 ±2.54	279 ±2.54	5.1	3.0	50
(1/2)	(10.0 ±0.1)	(11.0 ±0.1)	(0.20)	(0.12)	(2)
0.0283	356 ±2.54	284 ±2.54	5.1	3.0	76
(1)	(14.0 ±0.1)	(11.2 ±0.1)	(0.20)	(0.12)	(3)

* **Note 1:** The indicated size of measure shall be for aggregates of nominal maximum size equal to or smaller than that listed.

** Measure may be the base of the air meter used in the FOP for AASHTO T 152.

*** Nominal maximum size: One sieve larger than the first sieve to retain more than 10 percent of the material using an agency specified set of sieves based on cumulative percent retained. Where large gaps in specification sieves exist, intermediate sieve(s) may be inserted to determine nominal maximum size.

Procedure Selection

There are two methods of consolidating the concrete – rodding and vibration. If the slump is greater than 75 mm (3 in.), consolidation is by rodding. When the slump is 25 to 75 mm (1 to 3 in.), internal vibration or rodding can be used to consolidate the sample, but the method used must be that required by the agency in order to obtain consistent, comparable results. For concrete with slump less than 25 mm (1 in.), consolidate the sample by internal vibration. Do not consolidate self-consolidating concrete (SCC).

When using measures greater than 0.0142 m³ (1/2 ft³) see AASHTO T 121.

Procedure

Sampling

1. Obtain the sample in accordance with the FOP for WAQTC TM 2. Testing may be performed in conjunction with the FOP for AASHTO T 152. When doing so, this FOP should be performed before the FOP for AASHTO T 152.

Note 2: If the two tests are being performed using the same sample, this test shall begin within five minutes of obtaining the sample.

Rodding

1. Determine and record the mass of the empty measure.
2. Dampen the inside of the measure and empty excess water.

3. Use the scoop to fill the measure approximately 1/3 full with concrete. Evenly distribute the concrete in a circular motion around the inner perimeter of the measure.
4. Consolidate the layer with 25 strokes of the tamping rod, using the rounded end. Distribute the strokes evenly over the entire cross section of the concrete. Rod throughout its depth without hitting the bottom too hard.
5. Tap around the perimeter of the measure smartly 10 to 15 times with the mallet to close voids and release trapped air.
6. Add the second layer, filling the measure about 2/3 full. Evenly distribute the concrete in a circular motion around the inner perimeter of the measure.
7. Consolidate this layer with 25 strokes of the tamping rod, penetrating about 25 mm (1 in.) into the bottom layer.
8. Tap around the perimeter of the measure smartly 10 to 15 times with the mallet.
9. Add the final layer, slightly overfilling the measure. Evenly distribute the concrete in a circular motion around the inner perimeter of the measure.
10. Consolidate this layer with 25 strokes of the tamping rod, penetrating about 25 mm (1 in.) into the second layer.
11. Tap around the perimeter of the measure smartly 10 to 15 times with the mallet.
12. After consolidation, the measure should be slightly over full, about 3 mm (1/8 in.) above the rim. If there is a great excess of concrete, remove a portion with the scoop. If the measure is under full, add a small quantity. This adjustment may be done only after consolidating the final layer and before striking off the surface of the concrete.
13. Continue with 'Strike-off and Determining Mass.'

Internal Vibration

1. Determine and record the mass of the empty measure.
2. Dampen the inside of the measure and empty excess water.
3. Use the scoop to fill the measure approximately 1/2 full with concrete. Evenly distribute the concrete in a circular motion around the inner perimeter of the measure.
4. Insert the vibrator at three different points in each layer. Do not let the vibrator touch the bottom or side of the measure. Continue vibration only long enough to achieve proper consolidation of the concrete. Over vibration may cause segregation and loss of appreciable quantities of intentionally entrained air.
5. Tap around the perimeter of the measure smartly 10 to 15 times with the mallet.
6. Slightly overfill the measure. Evenly distribute the concrete in a circular motion around the inner perimeter of the measure.
7. Insert the vibrator at three different points, penetrating the first layer approximately 25 mm (1 in.). Do not let the vibrator touch the side of the measure.
8. Tap around the perimeter of the measure smartly 10 to 15 times with the mallet.

9. After consolidation, the measure should be slightly over full, about 3 mm (1/8 in.) above the rim. If there is a great excess of concrete, remove a portion with the scoop. If the measure is under full, add a small quantity. This adjustment may be done only after consolidating the final layer and before striking off the surface of the concrete.
10. Continue with 'Strike-off and Determining Mass.'

Self-Consolidating Concrete

1. Determine and record the mass of the empty measure.
2. Dampen the inside of the measure and empty excess water.
3. Use the scoop to slightly overfill the measure. Evenly distribute the concrete in a circular motion around the inner perimeter of the measure.
5. Continue with 'Strike-off and Determining Mass.'

Strike-off and Determining Mass

1. Press the strike-off plate flat against the top surface, covering approximately 2/3 of the measure.
2. Withdraw the strike-off plate with a sawing motion to finish the 2/3 originally covered.
3. Cover the original 2/3 again with the plate; finishing the remaining 1/3 with a sawing motion (do not lift the plate; continue the sawing motion until the plate has cleared the surface of the measure).
4. Final finishing may be accomplished with several strokes with the inclined edge of the strike-off plate. The surface should be smooth and free of voids.
5. Clean off all excess concrete from the exterior of the measure including the rim.
6. Determine and record the mass of the measure and the concrete.
7. If the air content of the concrete is to be determined, ensure the rim (flange) is clean and proceed to 'Strike-off and Air Content' Step 3 of the FOP for AASHTO T 152.

Calculations

Mass of concrete in the measure

$$\text{concrete mass} = M_c - M_m$$

Where:

Concrete mass = mass of concrete in measure

M_c = mass of measure and concrete

M_m = mass of measure

Density

$$D = \frac{\text{concrete mass}}{V_m}$$

Where:

D = density of the concrete mix

V_m = volume of measure (Annex A)

Yield m^3

$$Y_{m^3} = \frac{W}{D}$$

Where:

Y_{m^3} = yield (m^3 of the batch of concrete)

W = total mass of the batch of concrete

Yield yd³

$$Y_{ft^3} = \frac{W}{D} \qquad Y_{yd^3} = \frac{Y_{ft^3}}{27ft^3/yd^3}$$

Where:

Y_{ft^3}	=	yield (ft ³ of the batch of concrete)
Y_{yd^3}	=	yield (yd ³ of the batch of concrete)
W	=	total mass of the batch of concrete
D	=	density of the concrete mix

Note 5: The total mass, W, includes the masses of the cement, water, and aggregates in the concrete.

Cement Content

$$N = \frac{N_t}{Y}$$

Where:

N	=	actual cementitious material content per Y_m^3 or Y_{yd^3}
N_t	=	mass of cementitious material in the batch
Y	=	Y_m^3 or Y_{yd^3}

Note 6: Specifications may require Portland Cement content and supplementary cementitious materials content.

Water Content

The mass of water in a batch of concrete is the sum of:

- water added at batch plant
- water added in transit
- water added at jobsite
- free water on coarse aggregate*
- free water on fine aggregate*
- liquid admixtures (if required by the agency)

*Mass of free water on aggregate

This information is obtained from concrete batch tickets collected from the driver. Use the Table 2 to convert liquid measures.

Table 2
Liquid Conversion Factors

To Convert From	To	Multiply By
Liters, L	Kilograms, kg	1.0
Gallons, gal	Kilograms, kg	3.785
Gallons, gal	Pounds, lb	8.34
Milliliters, mL	Kilograms, kg	0.001
Ounces, oz	Milliliters, mL	28.4
Ounces, oz	Kilograms, kg	0.0284
Ounces, oz	Pounds, lb	0.0625
Pounds, lb	Kilograms, kg	0.4536

Mass of free water on aggregate

$$Free\ Water\ Mass = CA\ or\ FC\ Aggregate - \frac{CA\ or\ FC\ Aggregate}{1 + (Free\ Water\ Percentage/100)}$$

Where:

- Free Water Mass = on coarse or fine aggregate
- FC or CA Aggregate = mass of coarse or fine aggregate
- Free Water Percentage = percent of moisture of coarse or fine aggregate

Water/Cement Ratio

$$\frac{Water\ Content}{C}$$

Where:

- Water Content = total mass of water in the batch
- C = total mass of cementitious materials

Example

Mass of concrete in measure (M_m)	16.290 kg (36.06 lb)
Volume of measure (V_m)	0.007079 m ³ (0.2494 ft ³)

From batch ticket:

Yards batched	4 yd ³
Cement	950 kg (2094 lb)
Fly ash	180 kg (397 lb)
Coarse aggregate	3313 kg (7305 lb)
Fine aggregate	2339 kg (5156 lb)
Water added at plant	295 L (78 gal)

Other

Water added in transit	0
Water added at jobsite	38 L (10 gal)
Total mass of the batch of concrete (W)	7115 kg (15,686 lb)
Moisture content of coarse aggregate	1.7%
Moisture content of coarse aggregate	5.9%

Density

$$D = \frac{M_m}{V_m}$$

$$D = \frac{16.920 \text{ kg}}{0.007079 \text{ m}^3} = 2390 \text{ kg/m}^3 \quad D = \frac{36.06 \text{ lb}}{0.2494 \text{ ft}^3} = 144.6 \text{ lb/ft}^3$$

Given:

$$M_m = 16.920 \text{ kg (36.06 lb)}$$

$$V_m = 0.007079 \text{ m}^3 (0.2494 \text{ ft}^3) \text{ (Annex A)}$$

Yield m³

$$Y_{m^3} = \frac{W}{D}$$

$$Y_{m^3} = \frac{7115 \text{ kg}}{2390 \text{ kg/m}^3} = 2.98 \text{ m}^3$$

Given:

$$\text{Total mass of the batch of concrete (W), kg} = 7115 \text{ kg}$$

Yield yd^3

$$Y_{ft^3} = \frac{W}{D}$$

$$Y_{yd^3} = \frac{Y_{ft^3}}{27 ft^3/yd^3}$$

$$Y_{ft^3} = \frac{15,686 lb}{144.6 lb/ft^3} = 108.48 ft^3 \quad Y_{yd^3} = \frac{108.48 ft^3}{27 ft^3/yd^3} = 4.02 yd^3$$

Given:

Total mass of the batch of concrete (W), lb = 15,686 lb

Cement Content

$$N = \frac{N_t}{Y}$$

$$N = \frac{950 kg + 180 kg}{2.98 m^3} = 379 kg/m^3 \quad N = \frac{2094 lb + 397 lb}{4.02 yd^3} = 620 lb/yd^3$$

Given:

N_t (cement) = 950 kg (2094 lb)

N_t (flyash) = 180 kg (397 lb)

Y = Y_m^3 or Y_{yd}^3

Note 6: Specifications may require Portland Cement content and supplementary cementitious materials content.

Free water

$$\text{Free Water Mass} = \text{CA or FC Aggregate} - \frac{\text{CA or FC Aggregate}}{1 + (\text{Free Water Percentage}/100)}$$

$$\text{CA Free Water} = 3313 \text{ kg} - \frac{3313 \text{ kg}}{1 + (1.7/100)} = 55 \text{ kg}$$

$$\text{CA Free Water} = 7305 \text{ lb} - \frac{7305 \text{ lb}}{1 + (1.7/100)} = 122 \text{ lb}$$

$$\text{FA Free Water} = 2339 \text{ kg} - \frac{2339 \text{ kg}}{1 + (5.9/100)} = 130 \text{ kg}$$

$$\text{FA Free Water} = 5156 \text{ lb} - \frac{5156 \text{ lb}}{1 + (5.9/100)} = 287 \text{ lb}$$

Given:

CA aggregate = 3313 kg (7305 lb)

FC aggregate = 2339 kg (5156 lb)

CA moisture content = 1.7%

FC moisture content = 5.9%

Water Content

Total of all water in the mix.

$$\text{Water Content} = [(78 \text{ gal} + 10 \text{ gal}) * 3.785 \text{ kg/gal}] + 55 \text{ kg} + 130 \text{ kg} = 518 \text{ kg}$$

$$\text{Water Content} = [(78 \text{ gal} + 10 \text{ gal}) * 8.34 \text{ lb/gal}] + 122 \text{ lb} + 287 \text{ lb} = 1143 \text{ lb}$$

Given:

$$\text{Water added at plant} = 295 \text{ L (78 gal)}$$

$$\text{Water added at the jobsite} = 38 \text{ L (10 gal)}$$

Water/ Cement Ratio

$$W/C = \frac{518 \text{ kg}}{950 \text{ kg} + 180 \text{ kg}} = 0.458 \quad W/C = \frac{1143 \text{ lb}}{2094 \text{ lb} + 397 \text{ lb}} = 0.459$$

Report 0.46

Report

- Results on forms approved by the agency
- Sample ID
- Density (unit weight) to the nearest 1 kg/m³ (0.1 lb/ft³)
- Yield to the nearest 0.01 m³ (0.01 yd³)
- Cement content to the nearest 1 kg/m³ (1 lb/yd³)
- Cementitious material content to the nearest 1 kg/m³ (1 lb/yd³)
- Water/Cement ratio to the nearest 0.01

ANNEX A – STANDARDIZATION OF MEASURE

(Mandatory Information)

Standardization is a critical step to ensure accurate test results when using this apparatus. Failure to perform the standardization procedures as described herein will produce inaccurate or unreliable test results.

Apparatus

- Listed in the FOP for AASHTO T 121
 - Measure
 - Balance or scale
 - Strike-off plate
- Thermometer: Standardized liquid-in-glass, or electronic digital total immersion type, accurate to 0.5°C (1°F)

Procedure

1. Determine the mass of the dry measure and strike-off plate.
2. Fill the measure with water at a temperature between 16°C and 29°C (60°F and 85°F) and cover with the strike-off plate in such a way as to eliminate bubbles and excess water.
3. Wipe the outside of the measure and cover plate dry, being careful not to lose any water from the measure.
4. Determine the mass of the measure, strike-off plate, and water in the measure.
5. Determine the mass of the water in the measure by subtracting the mass in Step 1 from the mass in Step 4.
6. Measure the temperature of the water and determine its density from Table A1, interpolating as necessary.
7. Calculate the volume of the measure, V_m , by dividing the mass of the water in the measure by the density of the water at the measured temperature.

Calculations

$$V_m = \frac{M}{D}$$

Where:

V_m = volume of the mold

M = mass of water in the mold

D = density of water at the measured temperature

Example

Mass of water in Measure = 7.062 kg (15.53 lb)

Density of water at 23°C (73.4°F) = 997.54 kg/m³ (62.274 lb/ft³)

$$V_m = \frac{7.062 \text{ kg}}{997.54 \text{ kg/m}^3} = 0.007079 \text{ m}^3 \quad V_m = \frac{15.53 \text{ lb}}{62.274 \text{ lb/ft}^3} = 0.2494 \text{ ft}^3$$

Table A1
Unit Mass of Water
15°C to 30°C

°C	(°F)	kg/m ³	(lb/ft ³)	°C	(°F)	kg/m ³	(lb/ft ³)
15	(59.0)	999.10	(62.372)	23	(73.4)	997.54	(62.274)
15.6	(60.0)	999.01	(62.366)	23.9	(75.0)	997.32	(62.261)
16	(60.8)	998.94	(62.361)	24	(75.2)	997.29	(62.259)
17	(62.6)	998.77	(62.350)	25	(77.0)	997.03	(62.243)
18	(64.4)	998.60	(62.340)	26	(78.8)	996.77	(62.227)
18.3	(65.0)	998.54	(62.336)	26.7	(80.0)	996.59	(62.216)
19	(66.2)	998.40	(62.328)	27	(80.6)	996.50	(62.209)
20	(68.0)	998.20	(62.315)	28	(82.4)	996.23	(62.192)
21	(69.8)	997.99	(62.302)	29	(84.2)	995.95	(62.175)
21.1	(70.0)	997.97	(62.301)	29.4	(85.0)	995.83	(62.166)
22	(71.6)	997.77	(62.288)	30	(86.0)	995.65	(62.156)

Report

- Measure ID
- Date Standardized
- Temperature of the water
- Volume, V_m , of the measure



Oregon

Kate Brown, Governor

Department of Transportation

Construction Section
800 Airport Road SE
Salem, OR 97301-4792
Phone: (503) 986-3000
Fax: (503) 986-3096

October 31, 2020

To: All Holders of the Manual of Field Test Procedures

Section: **Test Procedure AASHTO T 152**

The Oregon Department of Transportation has specified method(s) for this Test Procedure. Please observe the following for our projects:

- **Under Annex A “Standardization of Air Meter Gauge”, delete the second paragraph and replace with the following: Standardization shall be performed at a minimum of once every three months or whenever test results are suspect. Record the date of the standardization, the standardization results, and the name of the technician performing the standardization in the log book kept with each air meter.**
- **Under Sampling, step 1, second sentence, delete 1 ½” and replace with 2”. Add the following sentence: If any aggregate is retained on the 2” sieve, wet sieve a sufficient amount of sample over the 1 ½” sieve according to the Wet Sieving portion of the FOP for WAQTC TM 2.**
- **An Aggregate Correction Factor is not required for Air Content Determination.**

AIR CONTENT OF FRESHLY MIXED CONCRETE BY THE PRESSURE METHOD FOP FOR AASHTO T 152

Scope

This procedure covers determination of the air content in freshly mixed Portland Cement Concrete containing dense aggregates in accordance with AASHTO T 152-19, Type B meter. It is not for use with lightweight or highly porous aggregates. This procedure includes standardization of the Type B air meter gauge, Annex A.

Warning—Fresh Hydraulic cementitious mixtures are caustic and may cause chemical burns to skin and tissue upon prolonged exposure.

Apparatus

- Air meter: Type B, as described in AASHTO T 152
- Balance or scale: Accurate to 0.3 percent of the test load at any point within the range of use (for Method 1 standardization only)
- Tamping rod: 16 mm (5/8 in.) diameter and 400 mm (16 in.) to 600 mm (24 in.) long, having a hemispherical tip the same diameter as the rod. (Hemispherical means “half a sphere”; the tip is rounded like half of a ball.)
- Vibrator: frequency at least 9000 vibrations per minute (150 Hz), at least 19 to 38 mm (3/4 to 1 1/2 in.) in diameter but not greater than 38 mm (1 1/2 in.), and the length of the shaft shall be at least 75 mm (3 in.) than the depth of the section being vibrated.
- Scoop: a receptacle of appropriate size so that each representative increment of the concrete sample can be placed in the container without spillage.
- Container for water: rubber syringe (may also be a squeeze bottle)
- Strike-off bar: Approximately 300 mm x 22 mm x 3 mm (12 in. x 3/4 in. x 1/8 in.)
- Strike-off plate: A flat rectangular metal plate at least 6 mm (1/4 in.) thick or a glass or acrylic plate at least 12 mm (1/2 in.) thick, with a length and width at least 50 mm (2 in.) greater than the diameter of the measure with which it is to be used. The edges of the plate shall be straight and smooth within tolerance of 1.5 mm (1/16 in.).
Note 1: Use either the strike-off bar or strike-off plate; both are not required.
- Mallet: With a rubber or rawhide head having a mass of 0.57 ± 0.23 kg (1.25 ± 0.5 lb)

Procedure Selection

There are two methods of consolidating the concrete – rodding and vibration. If the slump is greater than 75 mm (3 in.), consolidation is by rodding. When the slump is 25 to 75 mm (1 to 3 in.), internal vibration or rodding can be used to consolidate the sample, but the method used must be that required by the agency in order to obtain consistent, comparable results. For concrete with slumps less than 25 mm (1 in.), consolidate the sample by internal vibration. Do not consolidate self-consolidating concrete (SCC).

Procedure

Sampling

1. Obtain the sample in accordance with the FOP for WAQTC TM 2. If the concrete mixture contains aggregate retained on the 37.5mm (1½ in.) sieve, the aggregate must be removed in accordance with the Wet Sieving portion of the FOP for WAQTC TM 2.

Testing shall begin within five minutes of obtaining the sample.

Rodding

1. Dampen the inside of the air meter measure and place on a firm level surface.
2. Use the scoop to fill the measure approximately 1/3 full with concrete. Evenly distribute the concrete in a circular motion around the inner perimeter of the measure.
3. Consolidate the layer with 25 strokes of the tamping rod, using the rounded end. Distribute the strokes evenly over the entire cross section of the concrete. Rod throughout its depth without hitting the bottom too hard.
4. Tap around the perimeter of the measure smartly 10 to 15 times with the mallet to close voids and release trapped air.
5. Add the second layer, filling the measure about 2/3 full. Evenly distribute the concrete in a circular motion around the inner perimeter of the measure.
6. Consolidate this layer with 25 strokes of the tamping rod, penetrating about 25 mm (1 in.) into the bottom layer.
7. Tap around the perimeter of the measure smartly 10 to 15 times with the mallet.
8. Add the final layer, slightly overfilling the measure. Evenly distribute the concrete in a circular motion around the inner perimeter of the measure.
9. Consolidate this layer with 25 strokes of the tamping rod, penetrating about 25 mm (1 in.) into the second layer.
10. Tap around the perimeter of the measure smartly 10 to 15 times with the mallet.
11. After consolidation, the measure should be slightly over full, about 3 mm (1/8 in.) above the rim. If there is a great excess of concrete, remove a portion with the trowel or scoop. If the measure is under full, add a small quantity. This adjustment may be done only after consolidating the final layer and before striking off the surface of the concrete.
12. Continue with ‘Strike-off and Air Content.’

Internal Vibration

1. Dampen the inside of the air meter measure and place on a firm level surface.
2. Use the scoop to fill the measure approximately 1/2 full with concrete. Evenly distribute the concrete in a circular motion around the inner perimeter of the measure.
3. Insert the vibrator at three different points. Do not let the vibrator touch the bottom or side of the measure. Remove the vibrator slowly, so that no air pockets are left in the material. Continue vibration only long enough to achieve proper consolidation of the concrete. Over vibration may cause segregation and loss of appreciable quantities of intentionally entrained air.
4. Tap around the perimeter of the measure smartly 10 to 15 times with the mallet.
5. Use the scoop to fill the measure a bit over full. Evenly distribute the concrete in a circular motion around the inner perimeter of the measure.
6. Insert the vibrator at three different points, penetrating the first layer approximately 25 mm (1 in.). Do not let the vibrator touch the side of the measure. Remove the vibrator slowly, so that no air pockets are left in the material. Continue vibration only long enough to achieve proper consolidation of the concrete. Over vibration may cause segregation and loss of appreciable quantities of intentionally entrained air.
7. Tap around the perimeter of the measure smartly 10 to 15 times with the mallet.
8. Continue with 'Strike-off and Air Content.'

Self-Consolidating Concrete

1. Dampen the inside of the air meter measure and place on a firm level surface.
2. Use the scoop to slightly overfill the measure. Evenly distribute the concrete in a circular motion around the inner perimeter of the measure.
3. Continue with 'Strike-off and Air Content.'

Strike-Off and Air Content

1. Strike off the surface of the concrete and finish it smoothly with a sawing action of the strike-off bar or plate, using great care to leave the measure just full. The surface should be smooth and free of voids.
2. Clean the top flange of the measure to ensure a proper seal.
3. Moisten the inside of the cover and check to see that both petcocks are open, and the main air valve is closed.
4. Clamp the cover on the measure.
5. Inject water through a petcock on the cover until water emerges from the petcock on the other side.

6. Incline slightly and gently rock the air meter until no air bubbles appear to be coming out of the second petcock. The petcock expelling water should be higher than the petcock where water is being injected. Return the air meter to a level position and verify that water is present in both petcocks.
7. Close the air bleeder valve and pump air into the air chamber until the needle goes past the initial pressure determined for the gauge. Allow a few seconds for the compressed air to cool.
8. Tap the gauge gently with one hand while slowly opening the air bleeder valve until the needle rests on the initial pressure. Close the air bleeder valve.
9. Close both petcocks.
10. Open the main air valve.
11. Tap the side of the measure smartly with the mallet.
12. With the main air valve open, lightly tap the gauge to settle the needle, and then read the air content to the nearest 0.1 percent.
13. Release or close the main air valve.
14. Open both petcocks to release pressure, remove the concrete, and thoroughly clean the cover and measure with clean water.
15. Open the main air valve to relieve the pressure in the air chamber.

Report

- On forms approved by the agency
- Sample ID
- Percent of air to the nearest 0.1 percent.
- Some agencies require an aggregate correction factor in order to determine total percent of entrained air.

Total % entrained air = Gauge reading – aggregate correction factor from mix design
(See AASHTO T 152 for more information.)

ANNEX A
STANDARDIZATION OF AIR METER GAUGE

(Mandatory Information)

Standardization is a critical step to ensure accurate test results when using this apparatus. Failure to perform the standardization procedures as described below will produce inaccurate or unreliable test results.

Standardization shall be performed at a minimum of once every three months. Record the date of the standardization, the standardization results, and the name of the technician performing the standardization in the logbook kept with each air meter.

There are two methods for standardizing the air meter, mass or volume, both are covered below.

1. Screw the short piece of straight tubing into the threaded petcock hole on the underside of the cover.
2. Determine and record the mass of the dry, empty air meter measure and cover assembly (mass method only).
3. Fill the measure nearly full with water.
4. Clamp the cover on the measure with the tube extending down into the water. Mark the petcock with the tube attached for future reference.
5. Add water through the petcock having the pipe extension below until all air is forced out the other petcock. Rock the meter slightly until all air is expelled through the petcock.
6. Wipe off the air meter measure and cover assembly; determine and record the mass of the filled unit (mass method only).
7. Pump up the air pressure to a little beyond the predetermined initial pressure indicated on the gauge. Wait a few seconds for the compressed air to cool, and then stabilize the gauge hand at the proper initial pressure by pumping up or relieving pressure, as needed.
8. Close both petcocks and immediately open the main air valve exhausting air into the measure. Wait a few seconds until the meter needle stabilizes. The gauge should now read 0 percent. If two or more tests show a consistent variation from 0 percent in the result, change the initial pressure line to compensate for the variation, and use the newly established initial pressure line for subsequent tests.
9. Determine which petcock has the straight tube attached to it. Attach the curved tube to external portion of the same petcock.
10. Pump air into the air chamber. Open the petcock with the curved tube attached to it. Open the main air valve for short periods of time until 5 percent of water by mass or volume has been removed from the air meter. Remember to open both petcocks to release the pressure in the measure and drain the water in the curved tube back into the measure. To determine the mass of the water to be removed, subtract the mass found in Step 2 from the mass found in Step 6. Multiply this value by 0.05. This is the mass of the water that must be removed. To remove 5 percent by volume, remove water until the external standardization vessel is level full.

Note A1: Many air meters are supplied with a standardization vessel(s) of known volume that are used for this purpose. Standardization vessel must be protected from crushing or denting. If an external standardization vessel is used, confirm what percentage volume it represents for the air meter being used. Vessels commonly represent 5 percent volume, but they are for specific size meters. This should be confirmed by mass.

11. Remove the curved tube. Pump up the air pressure to a little beyond the predetermined initial pressure indicated on the gauge. Wait a few seconds for the compressed air to cool, and then stabilize the gauge hand at the proper initial pressure by pumping up or relieving pressure, as needed.
12. Close both petcocks and immediately open the main air valve exhausting air into the measure. Wait a few seconds until the meter needle is stabilized. The gauge should now read 5.0 ± 0.1 percent. If the gauge is outside that range, the meter needs adjustment. The adjustment could involve adjusting the starting point so that the gauge reads 5.0 ± 0.1 percent when this standardization is run or could involve moving the gauge needle to read 5.0 percent. Any adjustment should comply with the manufacturer's recommendations.
13. When the gauge hand reads correctly at 5.0 percent, additional water may be withdrawn in the same manner to check the results at other values such as 10 percent or 15 percent.
14. If an internal standardization vessel is used, follow Steps 1 through 8 to set initial reading.
15. Release pressure from the measure and remove cover. Place the internal standardization vessel into the measure. This will displace 5 percent of the water in the measure. (See AASHTO T 152 for more information on internal standardization vessels.)
16. Place the cover back on the measure and add water through the petcock until all the air has been expelled.
17. Pump up the air pressure chamber to the initial pressure. Wait a few seconds for the compressed air to cool, and then stabilize the gauge hand at the proper initial pressure by pumping up or relieving pressure, as needed.
18. Close both petcocks and immediately open the main air valve exhausting air into the measure. Wait a few seconds until the meter needle stabilizes. The gauge should now read 5 percent.
19. Remove the extension tubing from threaded petcock hole in the underside of the cover before starting the test procedure.

Report

- Air meter ID
- Date standardized
- Initial pressure (IP)



Oregon

Kate Brown, Governor

Department of Transportation

Construction Section
800 Airport Road SE
Salem, OR 97301-4792
Phone: (503) 986-3000
Fax: (503) 986-3096

October 31, 2018

To: All Holders of the Manual of Field Test Procedures

Section: **Test Procedure AASHTO T 166**

The Oregon Department of Transportation has specified method(s) for this Test Procedure. Please observe the following for our projects:

- **Absorption Calculations are not required.**
- **When performing the Bulk Specific Gravity determination for the Core Correlation process (ODOT TM-327), use Method A. Method C is required for dry mass determination.**
- **When performing the Bulk Specific Gravity determination for Lab Fabricated Gyratory Specimens, use Method A. The Method C option is not allowed.**
- **When performing the Bulk Specific Gravity determination for Cores removed for “density acceptance” purposes, see TM 327, “Procedure Density Cores”, section 4.4.**

BULK SPECIFIC GRAVITY (G_{mb}) OF COMPACTED ASPHALT MIXTURES USING SATURATED SURFACE-DRY SPECIMENS FOP FOR AASHTO T 166

Scope

This procedure covers the determination of bulk specific gravity (G_{mb}) of compacted asphalt mixtures using three methods – A, B, and C – in accordance with AASHTO T 166-16. This FOP is for use on specimens not having open or interconnecting voids or absorbing more than 2.00 percent water by volume, or both. When specimens have open or interconnecting voids or absorbing more than 2.00 percent water by volume, or both, AASHTO T 275 or AASHTO T 331 should be performed.

Overview

- Method A: Suspension
- Method B: Volumeter
- Method C: Rapid test for A or B

Test Specimens

Test specimens may be either laboratory-molded or sampled from asphalt mixture pavement. For specimens it is recommended that the diameter be equal to four times the maximum size of the aggregate and the thickness be at least one and one half times the maximum size.

Terminology

Constant Mass: The state at which a mass does not change more than a given percent, after additional drying for a defined time interval, at a required temperature.

Apparatus – Method A (Suspension)

- Balance or scale: 5 kg capacity, readable to 0.1 g, and fitted with a suitable suspension apparatus and holder to permit weighing the specimen while suspended in water, conforming to AASHTO M 231.
- Suspension apparatus: Wire of the smallest practical size and constructed to permit the container to be fully immersed.
- Water bath: For immersing the specimen in water while suspended under the balance or scale and equipped with an overflow outlet for maintaining a constant water level.
- Towel: Damp cloth towel used for surface drying specimens.
- Oven: Capable of maintaining a temperature of $110 \pm 5^{\circ}\text{C}$ ($230 \pm 9^{\circ}\text{F}$) for drying the specimens to a constant mass.

- Pan: Pan or other suitable container of known mass, large enough to hold a sample for drying in oven.
- Thermometer: Having a range of 19 to 27°C (66 to 80°F), graduated in 0.1°C (0.2°F) subdivisions.
- Vacuum device: refer to the FOP for AASHTO R 79 (optional)

Procedure – Method A (Suspension)

Recently molded laboratory samples that have not been exposed to moisture do not need drying.

1. Dry the specimen to constant mass, if required.
 - a. Oven method
 - i. Initially dry overnight at $52 \pm 3^\circ\text{C}$ ($125 \pm 5^\circ\text{F}$).
 - ii. Determine and record the mass of the specimen. Designate this mass as M_p .
 - iii. Return the specimen to the oven for at least 2 hours.
 - iv. Determine and record the mass of the specimen. Designate this mass as M_n .
 - v. Determine percent change by subtracting the new mass determination, M_n , from the previous mass determination, M_p , divide by the previous mass determination M_p , and multiply by 100.
 - vi. Continue drying until there is no more than 0.05 percent change in specimen mass after 2-hour drying intervals (constant mass).
 - vii. Constant mass has been achieved; sample is defined as dry.
 - b. Vacuum dry method according to the FOP for AASHTO R 79.
2. Cool the specimen in air to $25 \pm 5^\circ\text{C}$ ($77 \pm 9^\circ\text{F}$), and determine and record the dry mass to the nearest 0.1 g. Designate this mass as A.
3. Fill the water bath to overflow level with water at $25 \pm 1^\circ\text{C}$ ($77 \pm 1.8^\circ\text{F}$) and allow the water to stabilize.
4. Zero or tare the balance with the immersion apparatus attached, ensuring that the device is not touching the sides or the bottom of the water bath.
5. Immerse the specimen shaking to remove the air bubbles. Place the specimen on its side in the suspension apparatus. Leave it immersed for 4 ± 1 minutes.
6. Determine and record the submerged weight to the nearest 0.1 g. Designate this submerged weight as C.
7. Remove the sample from the water and quickly surface dry with a damp cloth towel within 5 seconds.

Note 1: To expedite the procedure, steps 1 and 2 may be performed last. To further expedite the process, see Method C.

8. Zero or tare the balance.
9. Immediately determine and record the mass of the saturated surface-dry (SSD) specimen to nearest 0.1 g. Designate this mass as B. Any water that seeps from the specimen during the mass determination is considered part of the saturated specimen. Do not exceed 15 seconds performing Steps 7 through 9.

Calculations – Method A (Suspension)

Constant Mass:

Calculate constant mass using the following formula:

$$\%Change = \frac{M_p - M_n}{M_p} \times 100$$

Where:

M_p = previous mass measurement, g

M_n = new mass measurement, g

Bulk specific gravity (G_{mb}) and percent water absorbed:

$$G_{mb} = \frac{A}{B - C}$$

$$\text{Percent Water Absorbed (by volume)} = \frac{B - A}{B - C} \times 100$$

Where:

A = Mass of dry specimen in air, g

B = Mass of SSD specimen in air, g

C = Weight of specimen in water at $25 \pm 1^\circ\text{C}$ ($77 \pm 1.8^\circ\text{F}$), g

Example:

$$G_{mb} = \frac{4833.6 \text{ g}}{4842.4 \text{ g} - 2881.3 \text{ g}} = 2.465$$

$$\% \text{ Water Absorbed (by volume)} = \frac{4842.4 \text{ g} - 4833.6 \text{ g}}{4842.4 \text{ g} - 2881.3 \text{ g}} \times 100 = 0.45\%$$

Given:

A	=	4833.6 g
B	=	4842.4 g
C	=	2881.3 g

Apparatus – Method B (Volumeter)

- Balance or scale: 5 kg capacity, readable to 0.1 g and conforming to AASHTO M 231.
- Water bath: Thermostatically controlled to $25 \pm 0.5^\circ\text{C}$ ($77 \pm 0.9^\circ\text{F}$).
- Thermometer: Range of 19 to 27°C (66 to 80°F) and graduated in 0.1°C (0.2°F) subdivisions.
- Volumeter: Calibrated to 1200 mL or appropriate capacity for test sample and having a tapered lid with a capillary bore.
- Oven: Capable of maintaining a temperature of $110 \pm 5^\circ\text{C}$ ($230 \pm 9^\circ\text{F}$) for drying the specimens to a constant mass.
- Pan: Pan or other suitable container of known mass, large enough to hold a sample for drying in oven.
- Towel: Damp cloth towel used for surface drying specimens.
- Vacuum device: refer to the FOP for AASHTO R 79 (optional)

Procedure – Method B (Volumeter)

Recently molded laboratory samples that have not been exposed to moisture do not need drying.

1. Dry the specimen to constant mass, if required.
 - a. Oven method:
 - i. Initially dry overnight at $52 \pm 3^{\circ}\text{C}$ ($125 \pm 5^{\circ}\text{F}$).
 - ii. Determine and record the mass of the specimen. Designate this mass as M_p .
 - iii. Return the specimen to the oven for at least 2 hours.
 - iv. Determine and record the mass of the specimen. Designate this mass as M_n .
 - v. Determine percent change by subtracting the new mass determination, M_n , from the previous mass determination, M_p , divide by the previous mass determination, M_p , and multiply by 100.
 - vi. Continue drying until there is no more than 0.05 percent change in specimen mass after 2-hour drying intervals (constant mass).
 - vii. Constant mass has been achieved; sample is defined as dry.
 - b. Vacuum dry method according to the FOP for AASHTO R 79.
2. Cool the specimen in air to $25 \pm 5^{\circ}\text{C}$ ($77 \pm 9^{\circ}\text{F}$), and determine and record the dry mass to the nearest 0.1 g. Designate this mass as A.
3. Immerse the specimen in the temperature-controlled water bath for at least 10 minutes.
4. Fill the volumeter with distilled water at $25 \pm 1^{\circ}\text{C}$ ($77 \pm 1.8^{\circ}\text{F}$) making sure some water escapes through the capillary bore of the tapered lid.
5. Wipe the volumeter dry. Determine the mass of the volumeter to the nearest 0.1 g. Designate this mass as D.
6. At the end of the ten-minute period, remove the specimen from the water bath and quickly surface dry with a damp cloth towel within 5 seconds.
7. Immediately determine and record the mass of the SSD specimen to the nearest 0.1 g. Designate this mass as B. Any water that seeps from the specimen during the mass determination is considered part of the saturated specimen.
8. Place the specimen in the volumeter and let stand 60 seconds.
9. Bring the temperature of the water to $25 \pm 1^{\circ}\text{C}$ ($77 \pm 1.8^{\circ}\text{F}$) and cover the volumeter, making sure some water escapes through the capillary bore of the tapered lid.
10. Wipe the volumeter dry.
11. Determine and record the mass of the volumeter and specimen to the nearest 0.1 g. Designate this mass as E.

Note 2: Method B is not acceptable for use with specimens that have more than 6 percent air voids.

Calculations – Method B (Volumeter)**Constant Mass:**

Calculate constant mass using the following formula:

$$\%Change = \frac{M_p - M_n}{M_p} \times 100$$

Where:

M_p = previous mass measurement, g

M_n = new mass measurement, g

Bulk specific gravity (G_{mb}) and percent water absorbed:

$$G_{mb} = \frac{A}{B + D - E}$$

$$\text{Percent Water Absorbed (by volume)} = \frac{B - A}{B + D - E} \times 100$$

Where:

G_{mb} = Bulk specific gravity

A = Mass of dry specimen in air, g

B = Mass of SSD specimen in air, g

D = Mass of volumeter filled with water at $25 \pm 1^\circ\text{C}$ ($77 \pm 1.8^\circ\text{F}$), g

E = Mass of volumeter filled with specimen and water, g

Example:

$$G_{mb} = \frac{4833.6 \text{ g}}{4842.4 \text{ g} + 2924.4 \text{ g} - 5806.0 \text{ g}} = 2.465$$

$$\% \text{ Water Absorbed (by volume)} = \frac{4842.4 \text{ g} - 4833.6 \text{ g}}{4842.4 \text{ g} + 2924.4 \text{ g} - 5806.0 \text{ g}} \times 100 = 0.45\%$$

Given:

A	=	4833.6 g
B	=	4842.4 g
D	=	2924.4 g
E	=	5806.0 g

Method C (Rapid Test for Method A or B)

See Methods A or B.

Note 3: This procedure can be used for specimens that are not required to be saved and contain substantial amounts of moisture. Cores can be tested the same day as obtained by this method.

Procedure – Method C (Rapid Test for Method A or B)

1. Start on Step 3 of Method A or B, and complete that procedure, then determine dry mass, A, as follows.
2. Determine and record mass of a large, flat-bottom container.
3. Place the specimen in the container.
4. Place in an oven at a minimum of 105°C (221°F). Do not exceed the Job Mix Formula mixing temperature.
5. Dry until the specimen can be easily separated into fine aggregate particles that are not larger than 6.3 mm (¼ in.).
6. Determine and record the mass of the specimen. Designate this mass as M_p .
7. Return the specimen to the oven for at least 2 hours.
8. Determine and record the mass of the specimen. Designate this mass as M_n .
9. Determine percent change by subtracting the new mass determination, M_n , from the previous mass determination, M_p , divide by the previous mass determination, M_p , and multiply by 100.

10. Continue drying until there is no more than 0.05 percent change in specimen mass after 2-hour drying intervals (constant mass).
11. Constant mass has been achieved; sample is defined as dry.
12. Cool in air to $25 \pm 5^{\circ}\text{C}$ ($77 \pm 9^{\circ}\text{F}$).
13. Determine and record the mass of the container and dry specimen to the nearest 0.1 g.
14. Determine and record the mass of the dry specimen to the nearest 0.1 g by subtracting the mass of the container from the mass determined in Step 13. Designate this mass as A.

Calculations – Method C (Rapid Test for Method A or B)

Complete the calculations as outlined in Methods A or B, as appropriate.

Report

- On forms approved by the agency
- Sample ID
- G_{mb} to the nearest 0.001
- Absorption to the nearest 0.01 percent
- Method performed.



Oregon

Kate Brown, Governor

Department of Transportation

Construction Section
800 Airport Road SE
Salem, OR 97301-4792
Phone: (503) 986-3000
Fax: (503) 986-3096

October 31, 2018

To: All Holders of the Manual of Field Test Procedures

Section: **Test Procedure AASHTO T 176**

The Oregon Department of Transportation has specified method(s) for this Test Procedure. Please observe the following for our projects:

- **Under Procedure, Delete Step 10e.**
- **Run a minimum of Two Sand Equivalent samples. If these results do not meet the requirements of "Procedure, Step 10d." run an additional three samples discarding the high and low results and average the remaining three samples.**

PLASTIC FINES IN GRADED AGGREGATES AND SOILS BY THE USE OF THE SAND EQUIVALENT TEST FOP FOR AASHTO T 176

Scope

This procedure covers the determination of plastic fines in accordance with AASHTO T 176-02. It serves as a rapid test to show the relative proportion of fine dust or clay-like materials in fine aggregates (FA) and soils.

Apparatus

See AASHTO T 176 for a detailed listing of sand equivalent apparatus. Note that the siphon tube and blow tube may be glass or stainless steel as well as copper.

- Graduated plastic cylinder.
- Rubber stopper.
- Irrigator tube.
- Weighted foot assembly: Having a mass of 1000 ± 5 g. There are two models of the weighted foot assembly. The older model has a guide cap that fits over the upper end of the graduated cylinder and centers the rod in the cylinder. It is read using a slot in the centering screws. The newer model has a sand-reading indicator 254 mm (10 in.) above this point and is preferred for testing clay-like materials.
- Bottle: clean, glass or plastic, of sufficient size to hold working solution
- Siphon assembly: The siphon assembly will be fitted to a 4 L (1 gal.) bottle of working calcium chloride solution placed on a shelf 915 ± 25 mm (36 ± 1 in.) above the work surface.
- Measuring can: With a capacity of 85 ± 5 mL (3 oz.).
- Funnel: With a wide-mouth for transferring sample into the graduated cylinder.
- Quartering cloth: 600 mm (2 ft.) square nonabsorbent cloth, such as plastic or oilcloth.
- Mechanical splitter: See the FOP for AASHTO R 76.
- Strike-off bar: A straightedge or spatula.
- Clock or watch reading in minutes and seconds.

- Manually-operated sand equivalent shaker: Capable of producing an oscillating motion at a rate of 100 complete cycles in 45 ± 5 seconds, with a hand assisted half stroke length of 127 ± 5 mm (5 ± 0.2 in.). It may be held stable by hand during the shaking operation. It is recommended that this shaker be fastened securely to a firm and level mount, by bolts or clamps, if a large number of determinations are to be made.
- Mechanical shaker: See AASHTO T 176 for equipment and procedure.
- Oven: Capable of maintaining a temperature of $110 \pm 5^\circ\text{C}$ ($230 \pm 9^\circ\text{F}$).
- Thermometer: Calibrated liquid-in-glass or electronic digital type designed for total immersion and accurate to 0.1°C (0.2°F).

Materials

- Stock calcium chloride solution: Obtain commercially prepared calcium chloride stock solution meeting AASHTO requirements.
- Working calcium chloride solution: Make 3.8 L (1 gal) of working solution. Fill the bottle with 2 L (1/2 gal) of distilled or demineralized water, add one 3 oz. measuring can (85 ± 5 mL) of stock calcium chloride solution. Agitate vigorously for 1 to 2 minutes. Add the remainder of the water, approximately 2 L (1/2 gal.) for a total of 3.8 L (1 gal) of working solution. Repeat the agitation process. Tap water may be used if it is proven to be non-detrimental to the test and if it is allowed by the agency. The shelf life of the working solution is approximately 30 days. Label working solution with the date mixed. Discard working solutions more than 30 days old.

Note 1: The graduated cylinder filled to 4.4 in. contains 88 mL and may be used to measure the stock solution.

Control

The temperature of the working solution should be maintained at $22 \pm 3^\circ\text{C}$ ($72 \pm 5^\circ\text{F}$) during the performance of the test. If field conditions preclude the maintenance of the temperature range, reference samples should be submitted to the Central/Regional Laboratory, as required by the agency, where proper temperature control is possible. Samples that meet the minimum sand equivalent requirement at a working solution temperature outside of the temperature range need not be subject to reference testing.

Sample Preparation

1. Obtain the sample in accordance with the FOP for AASHTO R 90 and reduce in accordance with the FOP for AASHTO R 76.
2. Sieve the sample over the 4.75 mm (No. 4) sieve. If the material is in clods, break it up and re-screen it over a 4.75 mm (No. 4) sieve. Clean all fines from particles retained on the 4.75 mm (No. 4) sieve and include with the material passing that sieve.

3. Split or quarter 1000 to 1500 g of material from the portion passing the 4.75 mm (No. 4) sieve. Use extreme care to obtain a truly representative portion of the original sample.

Note 2: Experiments show that, as the amount of material being reduced by splitting or quartering is decreased, the accuracy of providing representative portions is reduced. It is imperative that the sample be split or quartered carefully. When it appears necessary, dampen the material before splitting or quartering to avoid segregation or loss of fines.

Note 3: All tests, including reference tests, will be performed using Alternative Method No. 2 as described in AASHTO T 176, unless otherwise specified.

4. The sample must have the proper moisture content to achieve reliable results. This condition is determined by tightly squeezing a small portion of the thoroughly mixed sample in the palm of the hand. If the cast that is formed permits careful handling without breaking, the correct moisture content has been obtained.

Note 4: Clean sands having little 75 μm (No. 200), such as sand for Portland Cement Concrete (PCC), may not form a cast.

If the material is too dry, the cast will crumble and it will be necessary to add water and remix and retest until the material forms a cast. When the moisture content is altered to provide the required cast, the altered sample should be placed in a pan, covered with a lid or with a damp cloth that does not touch the material, and allowed to stand for a minimum of 15 minutes. Samples that have been sieved without being air-dried and still retain enough natural moisture are exempted from this requirement.

If the material shows any free water, it is too wet to test and must be drained and air dried. Mix frequently to ensure uniformity. This drying process should continue until squeezing provides the required cast.

5. Place the sample on the quartering cloth and mix by alternately lifting each corner of the cloth and pulling it over the sample toward the diagonally opposite corner, being careful to keep the top of the cloth parallel to the bottom, thus causing the material to be rolled. When the material appears homogeneous, finish the mixing with the sample in a pile near the center of the cloth.
6. Fill the measuring can by pushing it through the base of the pile while exerting pressure with the hand against the pile on the side opposite the measuring can. As the can is moved through the pile, hold enough pressure with the hand to cause the material to fill the tin to overflowing. Press firmly with the palm of the hand, compacting the material and placing the maximum amount in the can. Strike off the can level full with the straightedge or spatula.
7. When required, repeat steps 5 and 6 to obtain additional samples.

Procedure

1. Start the siphon by forcing air into the top of the solution bottle through the tube while the pinch clamp is open. Siphon 101.6 ± 2.5 mm (4 ± 0.1 in.) of working calcium chloride solution into the plastic cylinder.
2. Pour the prepared test sample from the measuring can into the plastic cylinder, using the funnel to avoid spilling.
3. Tap the bottom of the cylinder sharply on the heel of the hand several times to release air bubbles and to promote thorough wetting of the sample.
4. Allow the wetted sample to stand undisturbed for 10 ± 1 minutes.
5. At the end of the 10-minute period, stopper the cylinder and loosen the material from the bottom by simultaneously partially inverting and shaking the cylinder.
6. After loosening the material from the bottom of the cylinder, shake the cylinder and contents by any one of the following methods:
 - a. Mechanical Method – Place the stoppered cylinder in the mechanical shaker, set the timer, and allow the machine to shake the cylinder and contents for 45 ± 1 seconds.

Caution: Agencies may require additional operator qualifications for the next two methods.

- b. Manually-operated Shaker Method – Secure the stoppered cylinder in the three spring clamps on the carriage of the manually-operated sand equivalent shaker and set the stroke counter to zero. Stand directly in front of the shaker and force the pointer to the stroke limit marker painted on the backboard by applying an abrupt horizontal thrust to the upper portion of the right hand spring strap.

Remove the hand from the strap and allow the spring action of the straps to move the carriage and cylinder in the opposite direction without assistance or hindrance. Apply enough force to the right-hand spring steel strap during the thrust portion of each stroke to move the pointer to the stroke limit marker by pushing against the strap with the ends of the fingers to maintain a smooth oscillating motion. The center of the stroke limit marker is positioned to provide the proper stroke length and its width provides the maximum allowable limits of variation.

Proper shaking action is accomplished when the tip of the pointer reverses direction within the marker limits. Proper shaking action can best be maintained by using only the forearm and wrist action to propel the shaker. Continue shaking for 100 strokes.

- c. Hand Method – Hold the cylinder in a horizontal position and shake it vigorously in a horizontal linear motion from end to end. Shake the cylinder 90 cycles in approximately 30 seconds using a throw of $229 \text{ mm} \pm 25 \text{ mm}$ (9 ± 1 in.). A cycle is defined as a complete back and forth motion. To properly shake the cylinder at this

speed, it will be necessary for the operator to shake with the forearms only, relaxing the body and shoulders.

7. Set the cylinder upright on the work table and remove the stopper.
8. Insert the irrigator tube in the cylinder and rinse material from the cylinder walls as the irrigator is lowered. Force the irrigator through the material to the bottom of the cylinder by applying a gentle stabbing and twisting action while the working solution flows from the irrigator tip. Work the irrigator tube to the bottom of the cylinder as quickly as possible, since it becomes more difficult to do this as the washing proceeds. This flushes the fine material into suspension above the coarser sand particles.

Continue to apply a stabbing and twisting action while flushing the fines upward until the cylinder is filled to the 381 mm (15 in.) mark. Then raise the irrigator slowly without shutting off the flow so that the liquid level is maintained at about 381 mm (15 in.) while the irrigator is being withdrawn. Regulate the flow just before the irrigator is entirely withdrawn and adjust the final level to 381 mm (15 in.).

Note 5: Occasionally the holes in the tip of the irrigator tube may become clogged by a particle of sand. If the obstruction cannot be freed by any other method, use a pin or other sharp object to force it out, using extreme care not to enlarge the size of the opening. Also, keep the tip sharp as an aid to penetrating the sample.

9. Allow the cylinder and contents to stand undisturbed for 20 minutes \pm 15 seconds. Start timing immediately after withdrawing the irrigator tube.

Note 6: Any vibration or movement of the cylinder during this time will interfere with the normal settling rate of the suspended clay and will cause an erroneous result.

10. Clay and sand readings:

- a. At the end of the 20-minute sedimentation period, read and record the level of the top of the clay suspension. This is referred to as the clay reading.

Note 7: If no clear line of demarcation has formed at the end of the 20-minute sedimentation period, allow the sample to stand undisturbed until a clay reading can be obtained, then immediately read and record the level of the top of the clay suspension and the total sedimentation time. If the total sedimentation time exceeds 30 minutes, rerun the test using three individual samples of the same material. Read and record the clay column height of the sample requiring the shortest sedimentation period only. Once a sedimentation time has been established, subsequent tests will be run using that time. The time will be recorded along with the test results on all reports.

- b. After the clay reading has been taken, place the weighted foot assembly over the cylinder and gently lower the assembly until it comes to rest on the sand. Do not allow the indicator to hit the mouth of the cylinder as the assembly is being lowered. Subtract 254 mm (10 in.) from the level indicated by the extreme top edge of the indicator and record this value as the sand reading.
- c. If clay or sand readings fall between 2.5 mm (0.1 in.) graduations, record the level of the higher graduation as the reading. For example, a clay reading that appears to be 7.95 would be recorded as 8.0; a sand reading that appears to be 3.22 would be recorded as 3.3.

- d. If two Sand Equivalent (SE) samples are run on the same material and the second varies by more than ± 4 , based on the first cylinder result, additional tests shall be run.
- e. If three or more Sand Equivalent (SE) samples are run on the same material, average the results. If an individual result varies by more than ± 4 , based on the average result, additional tests shall be run.

Calculations

Calculate the SE to the nearest 0.1 using the following formula:

$$SE = \frac{\text{Sand Reading}}{\text{Clay Reading}} \times 100$$

Example

Given:

$$\begin{aligned} \text{Sand Reading} &= 3.3 \\ \text{Clay Reading} &= 8.0 \end{aligned}$$

$$SE = \frac{3.3}{8.0} \times 100 = 41.25 \text{ or } 41.3 \quad \text{Report } 42$$

Note 8: This example reflects the use of equipment made with English units. At this time, equipment made with metric units is not available.

Report the SE as the next higher whole number. In the example above, the 41.3 would be reported as 42. An SE of 41.0 would be reported as 41.

When averaging two or more samples, raise each calculated SE value to the next higher whole number (reported value) before averaging.

Example:

$$\begin{aligned} \text{calculated value 1} &= 41.3 \\ \text{calculated value 2} &= 42.8 \end{aligned}$$

These values are reported as 42 and 43, respectively.

Average the two reported values:

$$\text{Average SE} = \frac{42 + 43}{2} = 42.5 \quad \text{Report 43}$$

If the average value is not a whole number, raise it to the next higher whole number.

Report

- On forms approved by the agency
- Sample ID
- Results to the next higher whole number
- Sedimentation time if over 20 minutes

Test Procedure AASHTO T 209 Continued

- Under Section “Mixtures Containing Uncoated Porous Aggregates” or “Dryback” procedure observe the following:
 - a) Perform the “Dryback” procedure at the beginning of ACP production and after any JMF target adjustment.
 - b) The “Dryback Trigger” is based on a 2 test average. By computing the percent difference between, Mass of Sample in air (A) to Mass of saturated surface-dry sample in air (A_{ssd}) according to the following formula:

$$\frac{A_{ssd} - A}{A_{ssd}} \times 100 = \% \text{ Diff. (Compute to nearest 0.01\%)}$$

- c) If the calculated difference of startup results or the average of the 2 results after a JMF target adjustment exceeds 0.17%, then the “Dryback” procedure will be required for subsequent testing. Use the results of the “Dryback” procedure on all MDV and MAMD calculations.
- d) If the calculated results are 0.17% or less, then subsequent testing may be performed without the “Dryback” procedure.

Procedure – Mixtures Containing Uncoated Porous Aggregate

Delete steps 1 thru 3 and replace with the following

1. Within 5 minutes of completing ‘Procedure – General’, carefully drain water from the sample over a #40 or smaller opening sieve to prevent loss of material.
 2. Dry the sample by spreading it out in a container that has sides high enough to prevent material loss when stirred and is large enough to allow the sample to be in a layer no thicker than $\frac{3}{4}$ inch. Direct an electric fan so that it is blowing directly on the sample.
 3. After a minimum of 1 hour of continuous exposure to the fan, determine the mass of the sample. Stir the sample and spread out as in step 2. Continue to step 4.
- Under the calculation section, Theoretical Maximum Density, Delete the second sentence and replace with the following: The density of water at (77°F) is 62.4.



Oregon

Kate Brown, Governor

Department of Transportation

Construction Section
800 Airport Road SE
Salem, OR 97301-4792
Phone: (503) 986-3000
Fax: (503) 986-3096

November 30, 2020

To: All Holders of the Manual of Field Test Procedures

Section: **Test Procedure AASHTO T 209**

The Oregon Department of Transportation has specified method(s) for this Test Procedure. Please observe the following for our projects:

- **Under apparatus delete Bleeder valve and replace with, inline bleeder valve capable of regulating the vacuum between 25 & 30mm of mercury.**
- **Under the Standardization Section, delete the second sentence and add the following: The container shall be standardized annually and when the calibration value is in question.**
- **Use the flask method.**
- **Under Test Sample Preparation Section add the following: The test sample will be cured for a minimum of 1 hr. and a maximum of 3 hrs. according to the placement temperature range shown on the Mix Design. If the total time of storage and haul is less than 1 hour as determined by the Region QAC, Contractor CAT II and Project Manager then the test sample shall not be cured.**
- **Under the Procedure- (Pycnometer or Volumetric Flask) Delete step 12B, 13B and Note 2 and replace with the following: Fill the flask with (77.0°F +- 2°F) water and allow to stand for 10 ±1 minutes.**
- **Under Procedure – (Pycnometer or Volumetric Flask) Delete step 14B and replace with the following: The water temperature upon finishing filling the flask shall be at (77.0°F +- 2°F). Place the cover or a glass plate on the flask, and eliminate all air from the flask.**

(See Next Page)

THEORETICAL MAXIMUM SPECIFIC GRAVITY (G_{mm}) AND DENSITY OF ASPHALT MIXTURES FOP FOR AASHTO T 209

Scope

This procedure covers the determination of the maximum specific gravity (G_{mm}) of uncompacted asphalt mixtures in accordance with AASHTO T 209-20. Two methods using different containers – bowl and pycnometer / volumetric flask– are covered.

Specimens prepared in the laboratory shall be cured according to agency standards.

Apparatus

- Balance or scale: 10,000 g capacity, readable to 0.1 g, meeting AASHTO M 231, Class G2
- Container: A glass, metal, or plastic bowl, pycnometer or volumetric flask between 2000 and 10,000 mL as required by the minimum sample size requirements in Table 1 sample and capable of withstanding full vacuum applied
- Pycnometer / volumetric flask cover: A glass plate or a metal or plastic cover with a vented opening
- Vacuum lid: A transparent lid with a suitable vacuum connection, with a vacuum opening to be covered with a fine wire mesh
- Vacuum pump or water aspirator: Capable of evacuating air from the container to a residual pressure of 4.0 kPa (30 mm Hg)
- Vacuum measurement device: Residual pressure manometer or vacuum gauge, capable of measuring residual pressure down to 4.0 kPa (30 mm Hg) or less and accurate to 0.1 kPa (1 mm Hg)
- Manometer or vacuum gauge: Capable of measuring the vacuum being applied at the source of the vacuum
- Water bath: A constant-temperature water bath (optional for Pycnometer or Volumetric Flask Method)
- Thermometers: Thermometric devices accurate to 0.5°C (1°F)
- Bleeder valve to adjust vacuum
- Automatic vacuum control unit (optional)
- Timer
- Towel

Standardization

Use a container that has been standardized according to Annex A. The container shall be standardized periodically in conformance with procedures established by the agency.

Test Sample Preparation

1. Obtain samples in accordance with the FOP for AASHTO R 97 and reduce according to the FOP for AASHTO R 47.
2. Test sample size shall conform to the requirements of Table 1. Samples larger than the capacity of the container may be tested in two or more increments. Results will be combined by calculating the weighted average ($G_{mm (avg)}$). If the increments have a specific gravity difference greater than 0.014, the test must be re-run.

Table 1
Test Sample Size for G_{mm}

Nominal Maximum* Aggregate Size mm (in.)	Minimum Mass g
37.5 or greater (1½)	4000
19 to 25 (¾ to 1)	2500
12.5 or smaller (½)	1500

*Nominal maximum size: One sieve larger than the first sieve to retain more than 10 percent of the material using an agency specified set of sieves based on cumulative percent retained.

Procedure – General

Two procedures – bowl and pycnometer / volumetric flask – are covered. The first 11 steps are the same for both.

1. Separate the particles of the sample, taking care not to fracture the mineral particles, so that the particles of the fine aggregate portion are not larger than 6.3 mm (¼ in.). If the mixture is not sufficiently soft to be separated manually, place it in a large flat pan and warm in an oven only until it is pliable enough for separation.
2. Cool the sample to room temperature.
3. Determine and record the mass of the dry container to the nearest 0.1 g.
4. Place the sample in the container.
5. Determine and record the mass of the dry container and sample to the nearest 0.1 g.
6. Determine and record the mass of the sample by subtracting the mass determined in Step 3 from the mass determined in Step 5. Designate this mass as “A.”
7. Add sufficient water at approximately 25° C (77° F) to cover the sample by about 25 mm (1 in.).

Note 1: The release of entrapped air may be facilitated by the addition of a wetting agent. Check with the agency to see if this is permitted and, if it is, for a recommended agent.

8. Place the lid on the container and attach the vacuum line. To ensure a proper seal between the container and the lid, wet the O-ring or use a petroleum gel.
9. Remove entrapped air by subjecting the sample to a partial vacuum of 3.7 ± 0.3 kPa (27.5 ± 2.5 mm Hg) residual pressure for 15 ± 2 minutes.
10. Agitate the container and sample, either continuously by mechanical device or manually by vigorous shaking, at 2-minute intervals. This agitation facilitates the removal of air.
11. Release the vacuum. Increase the pressure to atmospheric pressure in 10 to 15 seconds if the vacuum release is not automated. Turn off the vacuum pump and remove the lid. When performing the pycnometer / volumetric flask method, complete steps 12B through 16B within 10 ± 1 minute.

Procedure – Bowl

- 12A. Fill the water bath to overflow level with water at $25 \pm 1^\circ\text{C}$ ($77 \pm 2^\circ\text{F}$) and allow the water to stabilize.
- 13A. Zero or tare the balance with the immersion apparatus attached, ensuring that the device is not touching the sides or the bottom of the water bath.
- 14A. Suspend and immerse the bowl and sample in water at $25 \pm 1^\circ\text{C}$ ($77 \pm 2^\circ\text{F}$) for 10 ± 1 minute. The holder shall be immersed sufficiently to cover both it and the bowl.
- 15A. Determine and record the submerged weight of the bowl and sample to the nearest 0.1 g. Designate as 'C.'

Procedure – Pycnometer or Volumetric Flask

- 12B. Immediately fill the pycnometer / volumetric flask with water without reintroducing air.
- 13B. Stabilize the temperature of the pycnometer / volumetric flask and sample so that the final temperature is within $25 \pm 1^\circ\text{C}$ ($77 \pm 2^\circ\text{F}$).
- 14B. Finish filling the pycnometer / volumetric flask with water that is $25 \pm 1^\circ\text{C}$ ($77 \pm 2^\circ\text{F}$), place the cover or a glass plate on the pycnometer / volumetric flask, and eliminate all air.

Note 2: When using a metal pycnometer and cover, place the cover on the pycnometer and push down slowly, forcing excess water out of the hole in the center of the cover. Use care when filling the pycnometer to avoid reintroducing air into the water.

- 15B. Towel dry the outside of the pycnometer / volumetric flask and cover.
- 16B. Determine and record the mass of the pycnometer / volumetric flask, cover, de-aired water, and sample to the nearest 0.1 g. within 10 ± 1 minute of completion of Step 11. Designate this mass as "E."

Procedure – Mixtures Containing Uncoated Porous Aggregate

If the pores of the aggregates are not thoroughly sealed by a bituminous film, they may become saturated with water during the vacuuming procedure, resulting in an error in maximum density. To determine if this has occurred, complete the general procedure and then:

1. Carefully drain water from sample through a towel held over the top of the container to prevent loss of material.
2. Spread sample in a flat shallow pan and place before an electric fan to remove surface moisture.
3. Determine the mass of the sample when the surface moisture appears to be gone.
4. Continue drying and determine the mass of the sample at 15-minute intervals until less than a 0.5 g loss is found between determinations.
5. Record the mass as the saturated surface dry mass to the nearest 0.1 g. Designate this mass as “A_{SSD}.”
6. Calculate, as indicated below, G_{mm} using “A” and “A_{SSD},” and compare the two values.

Calculation

Calculate the G_{mm} to three decimal places as follows:

Bowl Procedure

$$G_{mm} = \frac{A}{A + B - C} \quad \text{or} \quad G_{mm} = \frac{A}{A_{SSD} + B - C}$$

(for mixes containing uncoated aggregate materials)

Where:

- A = mass of dry sample in air, g
- A_{SSD} = mass of saturated surface dry sample in air, g
- B = standardized submerged weight of the bowl, g, (see Annex A)
- C = submerged weight of sample and bowl, g

Example:

$$G_{mm} = \frac{1432.7 \text{ g}}{1432.7 \text{ g} + 286.3 \text{ g} - 1134.9 \text{ g}} = 2.453 \quad \text{or}$$

$$G_{mm} = \frac{1432.7 \text{ g}}{1434.2 \text{ g} + 286.3 \text{ g} - 1134.9 \text{ g}} = 2.447$$

Given:

$$A = 1432.7 \text{ g}$$

$$A_{SSD} = 1434.2 \text{ g}$$

$$B = 286.3 \text{ g}$$

$$C = 1134.9 \text{ g}$$

Pycnometer / Volumetric Flask Procedure

$$G_{mm} = \frac{A}{A + D - E} \quad \text{or} \quad G_{mm} = \frac{A}{A_{SSD} + D - E}$$

(for mixtures containing uncoated materials)

Where:

A = mass of dry sample in air, g

A_{SSD} = mass of saturated surface-dry sample in air, g

D = standardized mass of pycnometer / volumetric flask filled with water at 25°C (77°F), g, (See Annex A)

E = mass of pycnometer / volumetric flask filled with water and the test sample at test temperature, g

Example (two increments of a large sample):

$$G_{mm_1} = \frac{2200.3 \text{ g}}{2200.3 \text{ g} + 7502.5 \text{ g} - 8812.0 \text{ g}} = 2.470$$

$$G_{mm_2} = \frac{1960.2 \text{ g}}{1960.2 \text{ g} + 7525.5 \text{ g} - 8690.8 \text{ g}} = 2.466$$

Given:

Increment 1	Increment 2
A ₁ = 2200.3 g	A ₂ = 1960.2 g
D ₁ = 7502.5 g	D ₂ = 7525.5 g
E ₁ = 8812.0 g	E ₂ = 8690.8 g

$$\text{Variation} = 2.470 - 2.466 = 0.004, \text{ which is } < 0.014$$

Allowable variation is: 0.014. The values may be used.

Weighted average

For large samples tested a portion at a time, calculate the $G_{mm(avg)}$ by multiplying the dry mass of each increment by its G_{mm} , add the results together (Σ) and divide by the sum (Σ) of the dry masses.

$$G_{mm(avg)} = \frac{\Sigma(A_x \times G_{mm_x})}{\Sigma A_x}$$

or

$$G_{mm(avg)} = \frac{(A_1 \times G_{mm_1}) + (A_2 \times G_{mm_2})}{A_1 + A_2} \text{ etc.}$$

Where:

- A_x = mass of dry sample increment in air, g
- G_{mmx} = theoretical maximum specific gravity of the increment

Example:

$$G_{mm(avg)} = \frac{(2200.3 \text{ g} \times 2.470) + (1960.2 \text{ g} \times 2.466)}{2200.3 \text{ g} + 1960.2 \text{ g}} = \frac{10,268.6}{4160.5 \text{ g}} = 2.468$$

Theoretical Maximum Density

To calculate the theoretical maximum density at 25°C (77°F) use one of the following formulas. The density of water at 25°C (77°F) is 997.1 in Metric units or 62.245 in English units.

$$\text{Theoretical maximum density kg/m}^3 = G_{mm} \times 997.1 \text{ kg/ m}^3$$

$$2.468 \times 997.1 \text{ kg/ m}^3 = 2461 \text{ kg/ m}^3$$

or

$$\text{Theoretical maximum density lb/ft}^3 = G_{mm} \times 62.245 \text{ lb/ft}^3$$

$$2.468 \times 62.245 \text{ lb/ft}^3 = 153.6 \text{ lb/ft}^3$$

Report

- On forms approved by the agency
- Sample ID
- G_{mm} to the nearest 0.001
- Theoretical maximum density to the nearest 1 kg/m³ (0.1 lb/ft³)

ANNEX A – STANDARDIZATION OF BOWL AND PYCNOMETER OR VOLUMETRIC FLASK

(Mandatory Information)

Bowl – Standardization

1. Fill the water bath to overflow level with $25 \pm 1^{\circ}\text{C}$ ($77 \pm 2^{\circ}\text{F}$) water and allow the water to stabilize.
2. Zero or tare the balance with the immersion apparatus attached, ensuring that the device is not touching the sides or the bottom of the water bath.
3. Suspend and completely immerse the bowl for 10 ± 1 minute.
4. Determine and record the submerged weight of the bowl to the nearest 0.1 g.
5. Refill the water bath to overflow level.
6. Repeat Steps 2 through 5 two more times for a total of three determinations.
7. If the three determinations are within 0.3 g., average the determinations. Designate as “B.”
8. If the variation of the three determinations is greater than 0.3 g., take corrective action and perform the standardization procedure again.

Bowl – Check

1. Fill the water bath to overflow level $25 \pm 1^{\circ}\text{C}$ ($77 \pm 2^{\circ}\text{F}$) water and allow the water to stabilize.
2. Zero or tare the balance with the immersion apparatus attached, ensuring that the device is not touching the sides or the bottom of the water bath.
3. Suspend and completely immerse the bowl for 10 ± 1 minute.
4. Determine and record the submerged weight of the bowl to the nearest 0.1 g.
5. If this determination is within 0.3 g of the standardized value, use the standardized value for “B.”
6. If it is not within 0.3 g, take corrective action and perform the standardization procedure again.

Pycnometer or Volumetric Flask – Standardization

1. Fill the pycnometer / volumetric flask with water at approximately 25°C (77°F).
2. Place the metal or plastic cover, or a glass plate on the pycnometer / volumetric flask and eliminate all air. (See Note 2.)
3. Stabilize the pycnometer / volumetric flask at $25 \pm 1^{\circ}\text{C}$ ($77 \pm 2^{\circ}\text{F}$) for 10 ± 1 min.
4. Towel dry the outside of the pycnometer / volumetric flask and cover.
5. Determine and record the mass of the pycnometer / volumetric flask, water, and lid to the nearest 0.1 g.

6. Repeat Steps 2 through 5 two more times for a total of three determinations.
7. If the three determinations are within 0.3 g, average the three determinations. Designate as “D.”
8. If the variation of the determinations is greater than 0.3 g., take corrective action and perform the “Pycnometer or Volumetric Flask – Standardization” again.

Pycnometer or Volumetric Flask – Check

1. Fill the pycnometer / volumetric flask with water at approximately 25°C (77°F).
2. Place the metal or plastic cover or a glass plate on the pycnometer / volumetric flask and eliminate all air. (See Note 2.)
3. Stabilize the pycnometer / volumetric flask at $25 \pm 1^\circ\text{C}$ ($77 \pm 2^\circ\text{F}$) for 10 ± 1 min.
4. Towel dry the outside of the pycnometer / volumetric flask and cover.
5. Determine and record the mass of the pycnometer / volumetric flask, water, and lid.
6. If this determination is within 0.3 g of the standardized value, use the standardized value for “D.”
7. If it is not within 0.3 g, perform the standardization procedure again.



Oregon

Kate Brown, Governor

Department of Transportation

Construction Section
800 Airport Road SE
Salem, OR 97301-4792
Phone: (503) 986-3000
Fax: (503) 986-3096

October 1, 2018

To: All Holders of the Manual of Field Test Procedures

Section: **Test Procedure AASHTO T 217**

The Oregon Department of Transportation has specified method(s) for this Test Procedure. Please observe the following for our projects:

- **Procedure- Delete step 7 and replace with the following: Rotate the vessel for 30 seconds, rest for 30 seconds and repeat until gauge dial reflects no further increase. A minimum of 3 rotations (3 minutes) is required. Allow time for the dissipation of heat generated by the chemical reaction, before taking the final reading.**
- **Procedure- Addendum to step 9, Use the following equation in lieu of the conversion curve to calculate the moisture content based on the dry weight of material.**
- **% Moisture based on Dry = $\frac{\% \text{ Moisture Gauge Reading}}{100 - \% \text{ Moisture Gauge Reading}} \times 100$**

DETERMINATION OF MOISTURE IN SOILS BY MEANS OF CALCIUM CARBIDE GAS PRESSURE MOISTURE TESTER FOP FOR AASHTO T 217

Scope

This procedure uses a calcium carbide gas pressure moisture tester to determine the moisture content of materials passing the No. 4 sieve in accordance with AASHTO T 217. This FOP does not apply to the Super 200 D tester (see AASHTO 217).

CAUTION: This procedure involves a potentially dangerous chemical reaction. When calcium carbide reacts with water, acetylene gas is produced. Breathing the acetylene gas and running the test where the potential for sparks or other ignition may cause a fire must be avoided.

Apparatus

- Calcium carbide gas pressure moisture tester.
- Balance or scale, conforming to the requirements for AASHTO M 231 and having a capacity of 2 kg and sensitive to 0.1 g. Most testers include a balance built into the transportation container.
- Cleaning brush and cloth.
- Scoop (or cap built into unit) for putting the soil sample into the pressure chamber. Some testers include a cap built into the unit.
- Steel balls, 31.75 mm (1.25 inch)

Material

- Calcium carbide reagent meeting the requirements of AASHTO T 217.

Note 1: Check the manufacturer's recommendations for storage requirements and the maximum shelf life for the calcium carbide reagent.

Procedure

1. Place three scoops, approximately 24 g, of calcium carbide, into the body of the moisture tester.
2. To prevent damage to the pressure gauge, place the moisture tester in a horizontal position before inserting the two steel balls into the vessel.
3. Obtain a representative wet mass sample of soil specified by the manufacturer, using the built-in balance or external scale. Transfer the soil mass to the moisture tester cap or scoop without loss of material.

Note 2: This method shall not be used on granular material retained on the No. 4 sieve where larger particles may affect the accuracy of the test.

Note 3: If the anticipated moisture content of the wet mass exceeds the capacity of the instrument being used, then one-half of the specified soil mass should be placed into the unit, and the resulting gauge reading multiplied by two.

4. With the instrument still in a horizontal position, so that calcium carbide does not come into contact with the soil, seat the cap on the body and tighten down on the clamp, thereby sealing the tester.
5. Carefully raise the unit to a vertical orientation and gently tap the cap to allow the soil to fall into the pressure vessel, taking care to prevent the steel balls from striking the bottom of the pressure vessel.
6. After the soil mass is introduced to the calcium carbide, return the vessel to a horizontal position. With a circular rotating motion vigorously roll the steel balls around the interior perimeter of the vessel to break up lumps of soil. Do not allow the steel balls to hit the cap or the bottom of the pressure vessel.
7. Continue this motion for 60 seconds. Allow time for the dissipation of the heat generated by the chemical reaction. Repeat motion and resting cycles until no further reaction occurs.
8. When the gauge needle stops moving, take a reading while holding the unit in a horizontal position at eye level.
9. Record the sample mass and the gauge reading. If the initial soil mass was reduced in half, multiply gauge reading by two.
10. Position the unit so that the cap is away from the user and slowly loosen the clamp to release the gas from the pressure chamber. Inspect the sample inside the pressure chamber. If it is not completely pulverized, a new sample must be obtained and tested after the instrument has been thoroughly cleaned.

Moisture Determination

1. The tester determines moisture content based on the wet mass of the soil. Moisture content based on the dry mass of soil is obtained from a conversion chart or curve supplied with each tester. See Figure 1 for curve from AASHTO T 217.

Note 4: Check the accuracy of the gauge and the conversion chart or curve periodically, in accordance with agency requirements, by testing samples of known moisture content. Develop correction factors, if necessary.

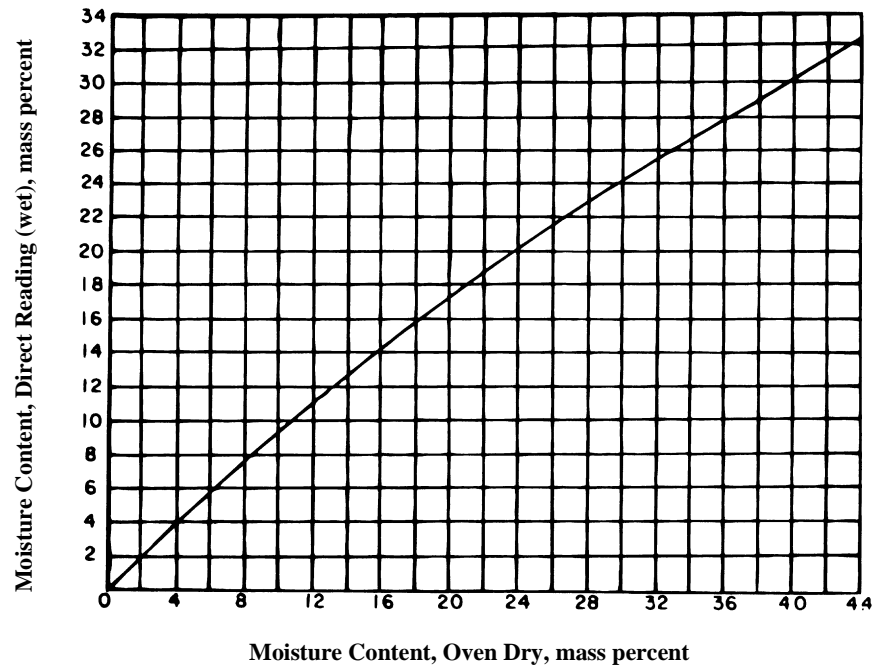
Figure 1**Conversion Curve for Moisture Tester Reading**

Example:

Gauge reading:	18.5
Conversion from chart:	22.1
Recorded % moisture:	22%

Report

Results shall be reported on standard forms approved by the agency. Report the moisture content to the nearest 0.1 percent.

Capping Cylindrical Concrete Specimens

AASHTO Designation: T 231-17
ASTM Designation: C 617-98 (2003)

AASHTO TEST METHODS CANNOT BE INCLUDED ON ODOT'S WEBSITE DUE TO COPYRIGHT INFRINGEMENT.

TO GET COPIES OF THE TEST METHODS, YOU MAY ORDER A HARD COPY OF ODOT'S **MANUAL OF FIELD TEST PROCEDURES** OR YOU MAY ORDER THE LATEST **STANDARD SPECIFICATIONS FOR TRANSPORTATION MATERIALS AND METHODS OF SAMPLING AND TESTING** FROM AASHTO.

To order ODOT's *Manual of Field Test Procedures*, use the following web address:

<https://www.oregon.gov/ODOT/Forms/2ODOT/7345110.pdf>

To order AASHTO's *Standard Specifications for Transportation Materials and Methods of Sampling and Testing*, visit the [AASHTO Store website](#)

**TOTAL EVAPORABLE MOISTURE CONTENT OF AGGREGATE BY DRYING
FOP FOR AASHTO T 255
LABORATORY DETERMINATION OF MOISTURE CONTENT OF SOILS
FOP FOR AASHTO T 265**

Scope

This procedure covers the determination of moisture content of aggregate and soil in accordance with AASHTO T 255-00 and AASHTO T 265-15. It may also be used for other construction materials.

Overview

Moisture content is determined by comparing the wet mass of a sample and the mass of the sample after drying to constant mass. The term constant mass is used to define when a sample is dry.

Constant mass – the state at which a mass does not change more than a given percent, after additional drying for a defined time interval, at a required temperature.

Apparatus

- Balance or scale: capacity sufficient for the principle sample mass, accurate to 0.1 percent of sample mass or readable to 0.1 g, and meeting the requirements of AASHTO M 231
- Containers, clean, dry, and capable of being sealed
- Suitable drying containers
- Microwave safe container with ventilated lid
- Heat source, controlled:
 - Forced draft oven
 - Ventilated oven
 - Convection oven
- Heat source, uncontrolled:
 - Infrared heater/heat lamp, hot plate, fry pan, or any other device/method that will dry the sample without altering the material being dried
 - Microwave oven (900 watts minimum)
- Utensils such as spoons
- Hot pads or gloves

Sample Preparation

In accordance with the FOP for AASHTO R 90 obtain a representative sample in its existing condition.

For aggregates the representative sample size is based on Table 1 or other information that may be specified by the agency.

TABLE 1
Sample Sizes for Moisture Content of Aggregate

Nominal Maximum Size* mm (in.)	Minimum Sample Mass g (lb)
4.75 (No. 4)	500 (1.1)
9.5 (3/8)	1500 (3.3)
12.5 (1/2)	2000 (4)
19.0 (3/4)	3000 (7)
25.0 (1)	4000 (9)
37.5 (1 1/2)	6000 (13)
50 (2)	8000 (18)
63 (2 1/2)	10,000 (22)
75 (3)	13,000 (29)
90 (3 1/2)	16,000 (35)
100 (4)	25,000 (55)
150 (6)	50,000 (110)

* One sieve larger than the first sieve to retain more than 10 percent of the material using an agency specified set of sieves based on cumulative percent retained. Where large gaps in specification sieves exist, intermediate sieve(s) may be inserted to determine nominal maximum.

For soils the representative sample size is based on Table 2 or other information that may be specified by the agency.

TABLE 2
Sample Sizes for Moisture Content of Soil

Maximum Particle Size mm (in.)	Minimum Sample Mass g
0.425 (No. 40)	10
4.75 (No. 4)	100
12.5 (1/2)	300
25.0 (1)	500
50 (2)	1000

Immediately seal or cover samples to prevent any change in moisture content or follow the steps in “Procedure.”

Procedure

Determine and record the sample mass as follows:

- For aggregate, determine and record all masses to the nearest 0.1 percent of the sample mass or to the nearest 0.1 g.
- For soil, determine and record all masses to the nearest 0.1 g.

When determining the mass of hot samples or containers or both, place and tare a buffer between the sample container and the balance. This will eliminate damage to or interference with the operation of the balance or scale.

1. Determine and record the mass of the container (and lid for microwave drying).
2. Place the wet sample in the container.
 - a. For oven(s), hot plates, infrared heaters, etc.: Spread the sample in the container.
 - b. For microwave oven: Heap sample in the container; cover with ventilated lid.
3. Determine and record the total mass of the container and wet sample.
4. Determine and record the wet mass of the sample (M_w) by subtracting the container mass determined in Step 1 from the mass of the container and sample determined in Step 3.
5. Place the sample in one of the following drying apparatus:
 - a. For aggregate –
 - i. Controlled heat source (oven): at $110 \pm 5^\circ\text{C}$ ($230 \pm 9^\circ\text{F}$).
 - ii. Uncontrolled heat source (Hot plate, infrared heater, etc.): Stir frequently to avoid localized overheating.
 - b. For soil – controlled heat source (oven): at $110 \pm 5^\circ\text{C}$ ($230 \pm 9^\circ\text{F}$).

Note 1: Soils containing gypsum or significant amounts of organic material require special drying. For reliable moisture contents dry these soils at 60°C (140°F). For more information see AASHTO T 265, Note 2.

6. Dry until sample appears moisture free.
7. Determine mass of sample and container.
8. Determine and record the mass of the sample by subtracting the container mass determined in Step 1 from the mass of the container and sample determined in Step 7.
9. Return sample and container to the heat source for additional drying.
 - a. For aggregate –
 - i. Controlled heat source (oven): 30 minutes
 - ii. Uncontrolled heat source (Hot plate, infrared heater, etc.): 10 minutes
 - iii. Uncontrolled heat source (Microwave oven): 2 minutes

Caution: Some minerals in the sample may cause the aggregate to overheat, altering the aggregate gradation.

- b. For soil – controlled heat source (oven): 1 hour
10. Determine mass of sample and container.
11. Determine and record the mass of the sample by subtracting the container mass determined in Step 1 from the mass of the container and sample determined in Step 10.
12. Determine percent change by subtracting the new mass determination (M_n) from the previous mass determination (M_p) divide by the previous mass determination (M_p) multiply by 100.
13. Continue drying, performing steps 9 through 12, until there is less than a 0.10 percent change after additional drying time.
14. Constant mass has been achieved; sample is defined as dry.
15. Allow the sample to cool. Immediately determine and record the total mass of the container and dry sample.
16. Determine and record the dry mass of the sample (M_D) by subtracting the mass of the container determined in Step 1 from the mass of the container and sample determined in Step 15.
17. Determine and record percent moisture (w) by subtracting the final dry mass determination (M_D) from the initial wet mass determination (M_W) divide by the final dry mass determination (M_D) multiply by 100.

**Table 3
Methods of Drying**

Aggregate		
Heat Source	Specific Instructions	Drying intervals to achieve constant mass (minutes)
Controlled:		
Forced draft (preferred), ventilated, or convection oven	110 ±5°C (230 ±9°F)	30
Uncontrolled:		
Hot plate, infrared heater, etc.	Stir frequently	10
Microwave	Heap sample and cover with ventilated lid	2
Soil		
Heat Source	Specific Instructions	Drying increments (minutes)
Controlled:		
Forced draft (preferred), ventilated, or convection oven	110 ±5°C (230 ±9°F)	1 hour

Calculation

Constant Mass:

Calculate constant mass using the following formula:

$$\% \text{ Change} = \frac{M_p - M_n}{M_p} \times 100$$

Where:

M_p = previous mass measurement

M_n = new mass measurement

Example:

Mass of container:	1232.1 g
Mass of container and sample after first drying cycle:	2637.2 g
Mass, M_p , of possibly dry sample:	$2637.2 \text{ g} - 1232.1 \text{ g} = 1405.1 \text{ g}$
Mass of container and sample after second drying cycle:	2634.1 g
Mass, M_n , of sample:	$2634.1 \text{ g} - 1232.1 \text{ g} = 1402.0 \text{ g}$

$$\% \text{ Change} = \frac{1405.1 \text{ g} - 1402.0 \text{ g}}{1405.1 \text{ g}} \times 100 = 0.22\%$$

0.22 percent is not less than 0.10 percent, so continue drying

Mass of container and sample after third drying cycle: 2633.0 g

Mass, M_n , of sample: $2633.0 \text{ g} - 1232.1 \text{ g} = 1400.9 \text{ g}$

$$\% \text{ Change} = \frac{1402.0 \text{ g} - 1400.9 \text{ g}}{1402.0 \text{ g}} \times 100 = 0.08\%$$

0.08 percent is less than 0.10 percent, so constant mass has been reached.

Moisture Content:

Calculate the moisture content, as a percent, using the following formula:

$$w = \frac{M_W - M_D}{M_D} \times 100$$

Where:

w = moisture content, percent

M_W = wet mass

M_D = dry mass

Example:

Mass of container: 1232.1 g

Mass of container and wet sample: 2764.7 g

Mass, M_W, of wet sample: 2764.7 g - 1232.1 g = 1532.6 g

Mass of container and dry sample (COOLED): 2633.5 g

Mass, M_D, of dry sample: 2633.5 g - 1232.1 g = 1401.4 g

$$w = \frac{1532.6 \text{ g} - 1401.4 \text{ g}}{1401.4 \text{ g}} \times 100 = \frac{131.2 \text{ g}}{1401.4 \text{ g}} \times 100 = 9.36\% \text{ report } 9.4\%$$

Report

- On forms approved by the agency
- Sample ID
- M_W, wet mass
- M_D, dry mass
- w, moisture content to the nearest 0.1 percent

EMBANKMENT AND BASE
IN-PLACE DENSITY

WAQTC

FOP AASHTO T 255 / T 265 (16)



Oregon

Kate Brown, Governor

Department of Transportation

Construction Section
800 Airport Road SE
Salem, OR 97301-4792
Phone: (503) 986-3000
Fax: (503) 986-3096

November 30, 2018

To: All Holders of the Manual of Field Test Procedures

Section: **Test Procedure AASHTO T 272**

The Oregon Department of Transportation has specified method(s) for this Test Procedure. Please observe the following for our projects:

- **AASHTO T 99 (Methods B & C) are not allowed on ODOT contracts.**
- **Use AASHTO T 99 (Methods A or D) based on the following criteria:**
- **The moisture content of the one point may be determined according to AASHTO T 217.**
- **The moisture content of the one point must be determined according to AASHTO T 255/265 for Method D applications.**
- **Under the calculations section, add the following: Wet density may be determined according to T 99 - Yellow Sheet, using a "Mold Factor".**
- **Under Section Maximum Dry Density and Optimum Moisture Content Determination Using a Family of Curves, if the one-point plot doesn't meet the requirements of this section (steps 2, 3, & 5), then a full curve must be developed or the guidelines for Selecting a Single Curve (Appendix A) located at the end of AASHTO T 272.**
- **Delete Section "Maximum Dry Density and Optimum Moisture Content Determination Using an Individual Moisture / Density Curve".**
- **Delete the Individual Moisture / Density Curve figure and example on page E&B/ID 16-6.**

ONE-POINT METHOD FOR DETERMINING MAXIMUM DRY DENSITY AND OPTIMUM MOISTURE FOP FOR AASHTO T 272

Scope

This procedure provides for a rapid determination of the maximum dry density and optimum moisture content of a soil sample, using a one-point determination in accordance with AASHTO T 272-18. This procedure is related to the FOPs for AASHTO T 99/T 180 and R 75.

One-point determinations are made by compacting the soil in a mold of a given size with a specified rammer dropped from a specified height and then compared to an individual moisture/density curve (FOP for AASHTO T 99 or T 180) or a family of curves (FOP for AASHTO R 75). Four alternate methods – A, B, C, and D – are used and correspond to the methods described in the FOP for AASHTO T 99/T 180. The method used in AASHTO T 272 must match the method used for the reference curve or to establish the family of curves. For example, when moisture-density relationships as determined by T 99 - Method C are used to form the family of curves or an individual moisture density curve, then T 99 - Method C must be used to for the one-point determination.

Apparatus

See the FOP for AASHTO T 99/T 180. Use the method matching the individual curve or Family of Curves. Refer to Table 1 of the FOP for AASHTO T 99 / T 180 for corresponding mold size, number of layers, number of blows, and rammer specification for the various test methods.

Sample

Sample size determined according to the FOP for AASHTO T 310. In cases where the existing individual curve or family cannot be used a completely new curve will need to be developed and the sample size will be determined by the FOP for AASHTO T 99/T 180.

If the sample is damp, dry it until it becomes friable under a trowel. Drying may be in air or by use of a drying apparatus maintained at a temperature not exceeding 60°C (140°F). Thoroughly break up aggregations in a manner that avoids reducing the natural size of individual particles.

Procedure

1. Determine the mass of the clean, dry mold. Include the base plate but exclude the extension collar. Record the mass to the nearest 1 g (0.005 lb).
2. Thoroughly mix the sample with sufficient water to adjust moisture content to 80 to 100 percent of the anticipated optimum moisture.
3. Form a specimen by compacting the prepared soil in the mold (with collar attached) in approximately equal layers. For each layer:
 - a. Spread the loose material uniformly in the mold.

Note 1: It is recommended to cover the remaining material with a non-absorbent sheet or damp cloth to minimize loss of moisture.

- b. Lightly tamp the loose material with the manual rammer or other similar device, this establishes a firm surface.
- c. Compact each layer with uniformly distributed blows from the rammer.
- d. Trim down material that has not been compacted and remains adjacent to the walls of the mold and extends above the compacted surface.
4. Remove the extension collar. Avoid shearing off the sample below the top of the mold. The material compacted in the mold should not be over 6 mm (¼ in.) above the top of the mold once the collar has been removed.
5. Trim the compacted soil even with the top of the mold with the beveled side of the straightedge.
6. Clean soil from exterior of the mold and base plate.
7. Determine the mass of the mold and wet soil to the nearest 1 g (0.005 lb) or better.
8. Determine the wet mass of the sample by subtracting the mass in Step 1 from the mass in Step 7.
9. Calculate the wet density as indicated below under “Calculations.”
10. Extrude the material from the mold. For soils and soil-aggregate mixtures, slice vertically through the center and take a representative moisture content sample from one of the cut faces, ensuring that all layers are represented. For granular materials, a vertical face will not exist. Take a representative sample. This sample must meet the sample size requirements of the test method used to determine moisture content.



Extruded material

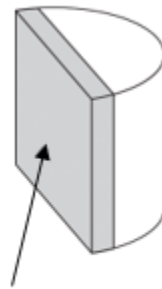

**Representative moisture
content sample**

11. Determine the moisture content of the sample in accordance with the FOP for AASHTO T 255 / T 265.

Calculations

1. Calculate the wet density, in kg/m^3 (lb/ft^3), by dividing the wet mass by the measured volume of the mold (T 19).

Example – Methods A or C mold:

Wet mass = 2.0055 kg (4.42 lb)

Measured volume of the mold = 0.0009469 m^3 (0.03344 ft^3)

$$\text{Wet Density} = \frac{2.0055 \text{ kg}}{0.0009469 \text{ m}^3} = 2118 \text{ kg/m}^3$$

$$\text{Wet Density} = \frac{4.42 \text{ lb}}{0.03344 \text{ ft}^3} = 132.2 \text{ lb/ft}^3$$

2. Calculate the dry density as follows.

$$\rho_d = \left(\frac{\rho_w}{w + 100} \right) \times 100 \quad \text{or} \quad \rho_d = \frac{\rho_w}{\left(\frac{w}{100} \right) + 1}$$

Where:

ρ_d = Dry density, kg/m^3 (lb/ft^3)

ρ_w = Wet density, kg/m^3 (lb/ft^3)

w = Moisture content, as a percentage

Example:

$\rho_w = 2118 \text{ kg/m}^3$ (132.2 lb/ft^3)

w = 13.5%

$$\rho_d = \left(\frac{2118 \text{ kg/m}^3}{13.5 + 100} \right) \times 100 = 1866 \text{ kg/m}^3 \quad \rho_d = \left(\frac{132.2 \text{ lb/ft}^3}{13.5 + 100} \right) \times 100 = 116.5 \text{ lb/ft}^3$$

or

$$\rho_d = \left(\frac{2118 \text{ kg/m}^3}{\frac{13.5}{100} + 1} \right) = 1866 \text{ kg/m}^3 \quad \rho_d = \left(\frac{132.2 \text{ lb/ft}^3}{\frac{13.5}{100} + 1} \right) = 116.5 \text{ lb/ft}^3$$

Maximum Dry Density and Optimum Moisture Content Determination Using an Individual Moisture / Density Curve

1. The moisture content must be within 80 to 100 percent of optimum moisture of the reference curve. Compact another specimen, using the same material, at an adjusted moisture content if the one-point does not fall in the 80 to 100 percent of optimum moisture range.
2. Plot the one-point, dry density on the vertical axis and moisture content on the horizontal axis, on the reference curve graph.
3. If the one-point falls on the reference curve or within ± 2.0 lbs/ft³, use the maximum dry density and optimum moisture content determined by the curve.
4. Use the FOP for AASHTO T 99/T 180 Annex A to determine corrected maximum dry density and optimum moisture content if oversize particles have been removed.
5. Perform a full moisture-density relationship if the one-point does not fall on or within ± 2.0 lbs/ft³ of the reference curve at 80 to 100 percent optimum moisture.

Example

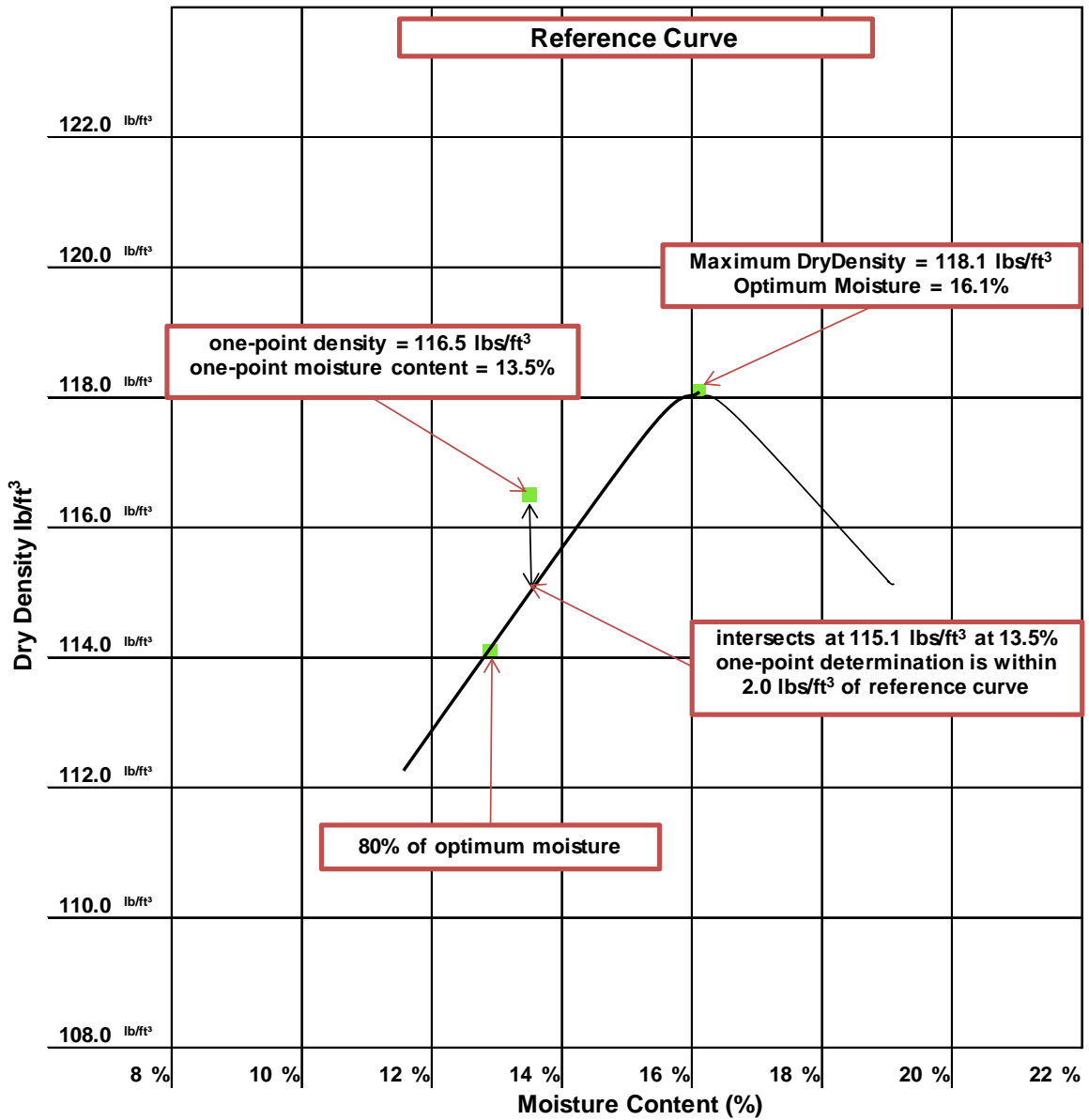

The results of a one-point determination were 116.5 lb/ft³ at 13.5 percent moisture. The point was plotted on the reference curve graph. The one-point determination is within 2.0 lb/ft³ of the point on the curve that corresponds with the moisture content.

Maximum Dry Density and Optimum Moisture Content Determination Using a Family of Curves

1. Plot the one-point, dry density on the vertical axis and moisture content on the horizontal axis, on the reference family of curves graph.
2. If the moisture-density one-point falls on one of the curves in the family of curves, use the maximum dry density and optimum moisture content defined by that curve.
3. If the moisture-density one-point falls within the family of curves but not on an existing curve, draw a new curve through the plotted single point, parallel and in character with the nearest existing curve in the family of curves. Use the maximum dry density and optimum moisture content as defined by the new curve.
 - a. The one-point must fall either between or on the highest or lowest curves in the family. If it does not, then a full curve must be developed.
 - b. If the one-point plotted within or on the family of curves does not fall in the 80 to 100 percent of optimum moisture content, compact another specimen, using the same material, at an adjusted moisture content that will place the one point within this range.
4. Use the FOP for AASHTO T 99/T 180 Annex A to determine corrected maximum dry density and optimum moisture content if oversize particles have been removed.
5. If the new curve through a one-point is not well defined or is in any way questionable, perform a full moisture-density relationship to correctly define the new curve and verify the applicability of the family of curves.

Note 2: New curves drawn through plotted single point determinations shall not become a permanent part of the family of curves until verified by a full moisture-density procedure following the FOP for AASHTO T 99/T 180.

Example

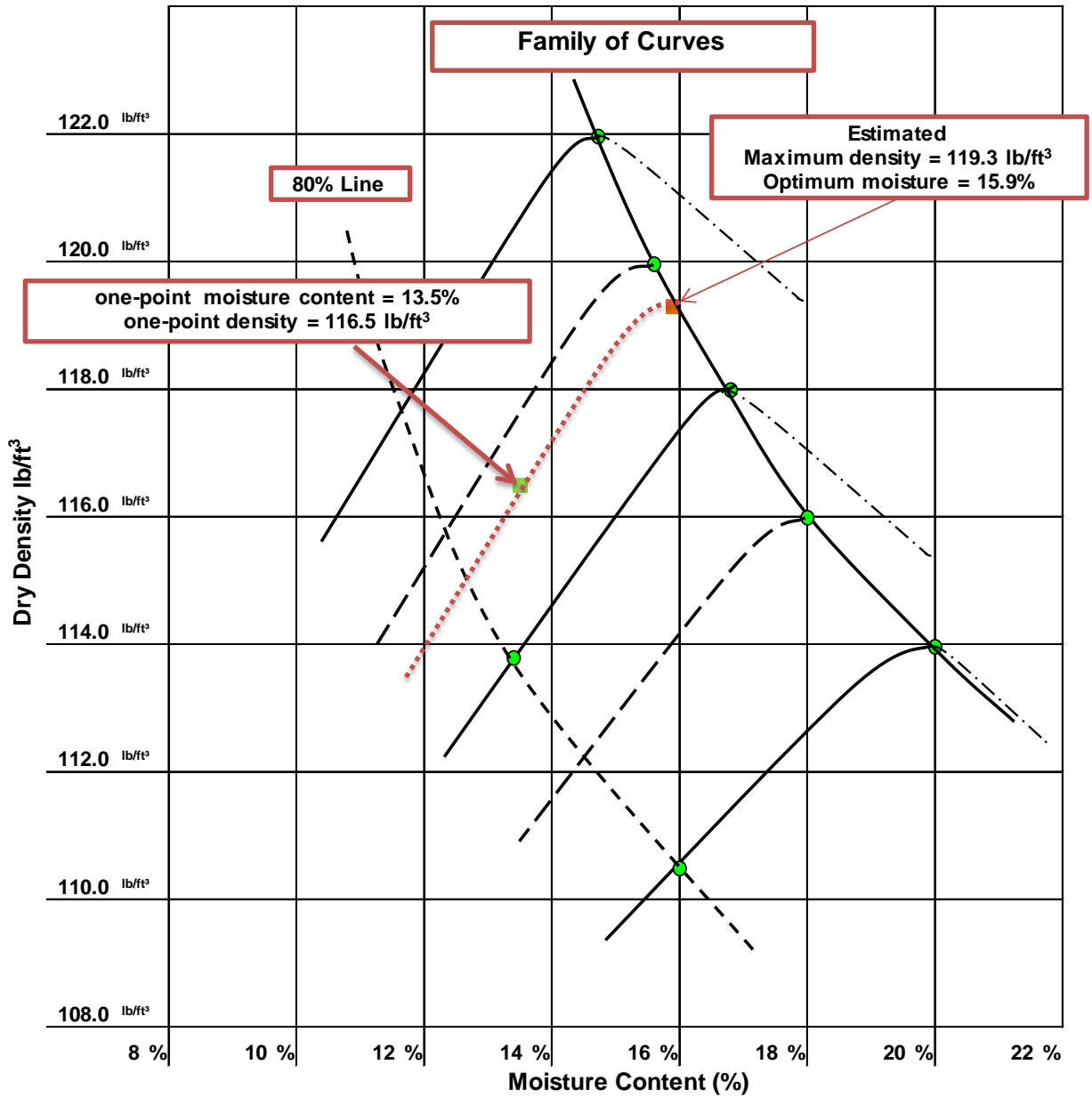

The results of a one-point determination were 116.5 lb/ft³ at 13.5 percent moisture. The point was plotted on the reference curve graph. The point was plotted on the appropriate family between two previously developed curves near and intermediate curve.

The “dotted” curve through the moisture-density one-point was sketched between the existing curves. A maximum dry density of 119.3 lb/ft³ and a corresponding optimum moisture content of 15.9 percent were estimated.

Report

- Results on forms approved by the agency
- Sample ID
- Maximum dry density to the nearest 1 kg/m^3 (0.1 lb/ft^3)
- Corrected maximum dry density (if applicable)
- Optimum moisture content to the nearest 0.1 percent
- Corrected optimum moisture content (if applicable)
- Reference curve or Family of Curves used

Appendix "A" Guidelines for Selecting a Single Curve

- 1) Select all curves where the One Point plots within 2 lbs/ft³ and 2.0% of the curve.
 - a) Plot the One Point on the curve.
 - b) Extend a line vertically 2 lbs/ft³ in length from the One Point towards the curve.
 - c) Extend a line Horizontally 2.0% in length from the One Point towards the curve.

Example Shown: The One Point is 67 lbs/ft³ @ 14% moisture. Therefore the horizontal extension is 12% (-2%) and the vertical extension is to 69 lbs/ft³ (+2lbs/ft³).

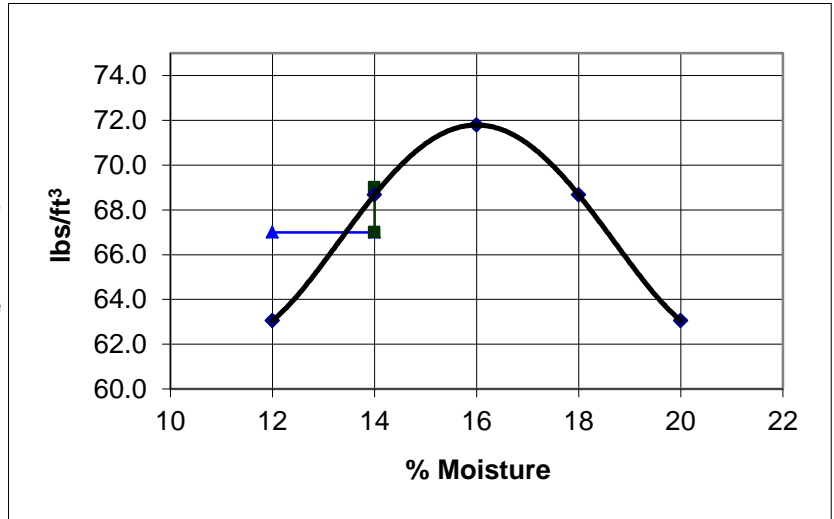

- 2) Retain only those curves where the One Point has a lower moisture content than the Optimum Moisture of the curve being used for comparison.
- 3) Review the remaining curves and select the curve which, best fits in order of the following parameters:
 - a) One Point closest to the "dry" curve line
 - b) Highest Maximum Density
 - c) Lowest Optimum Moisture

EXAMPLE

Curve #1

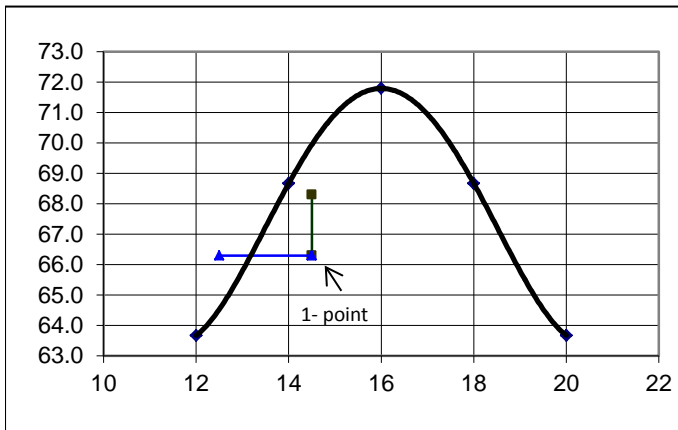

Curve #2

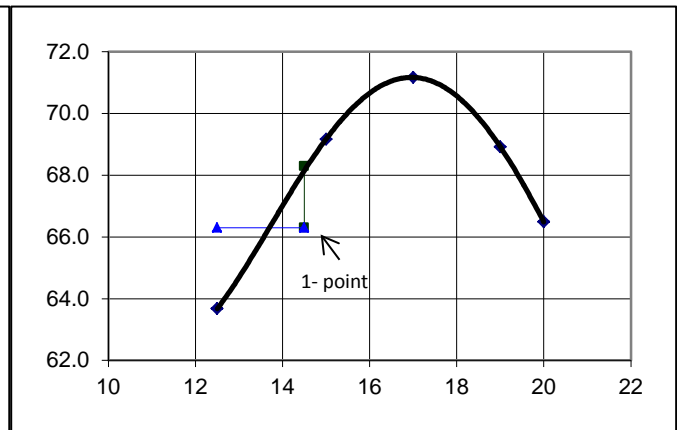

Curve #3

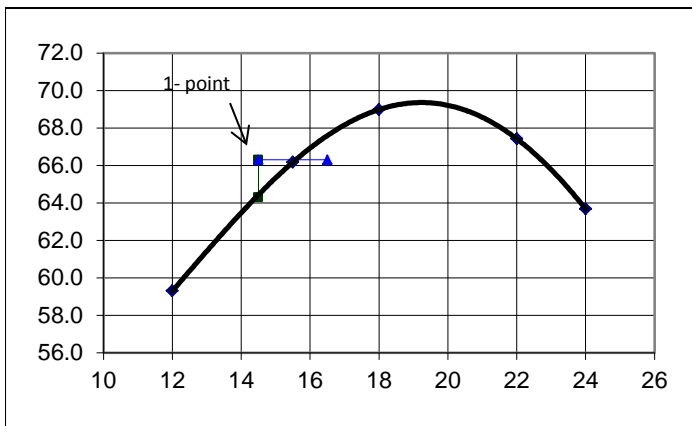

One Point = 66.3 lbs/ft³ @ 14.5% moisture

- 1) Only two curves meet requirement 1, (2 & 3).
- 2) Both curves 2 & 3 have higher Optimum moistures than the One Point Plot. Meeting requirement 2.
- 3) Therefore use requirement 3:
 - a) Curve 2 & 3 appear to be equal distant from the two curves
 - b) Curve 2 has the higher Maximum Density.

Therefore, use Curve # 2

Test Procedure AASHTO T 283 Continued

3. Of the remaining 2 specimens; select the specimen with the lowest air voids and designate it "Wet". The remaining specimen is designated "Dry"
- Test Sample with 8 Specimens:
 1. Of the initial 8 specimens; select the specimen with highest air voids and the specimen with the lowest air voids and designate them "Wet"
 2. Of the remaining 6 specimens; select the specimen with highest air voids and the specimen with the lowest air voids and designate them "Dry"
 3. Of the remaining 4 specimens; select the specimen with highest air voids and the specimen with the lowest air voids and designate them "Wet"
 4. The remaining 2 specimens are designated "Dry"

All Specimens

- Section 10.3.7, Delete this section. Freeze-thaw conditioning is not required.



Oregon

John A. Kitzhaber, M.D., Governor

Department of Transportation

Construction Section
800 Airport Road SE
Salem, OR 97301-4792
Phone: (503) 986-3000
Fax: (503) 986-3096

October 31, 2013

To: All Holders of the Manual of Field Test Procedures

Section: **Test Procedure AASHTO T 283**

The Oregon Department of Transportation has specified method(s) for this Test Procedure. Please observe the following for our projects:

Preparation of Lab-Mixed, Lab Compacted Specimens

- **Section 6.2, only 6” specimens are allowed for this step.**
- **Section 6.4, Do not perform the 2-hr cooling and 16-hr loose mix curing required by this section. After mixing place mixture in the specified pans and follow the steps in Section 6.5.**
- **Section 6.5, Compact each specimen to the required air void range.**
- **Section 6.6, Delete requirement for storage of 24 +/- 3 hours at room temperature. Instead, allow the compacted specimens to completely cool to room temperature (no longer than 24 hours). Then proceed to Section 9.**

Preparation of Field-Mixed, Lab compacted Specimens

- **Section 7.2, only 6” specimens are allowed for this step.**
- **Section 7.5, Delete requirement for storing specimens at 24 +/- 3 hours at room temperature. Instead allow compacted specimens too completely cool to room temperature (no longer than 24 hours). Then proceed to Section 9.**

Grouping of test Specimens for Conditioning

- **Test Sample with 6 Specimens:**
 1. **Of the initial 6 specimens; select the specimen with highest air voids and the specimen with the lowest air voids and designate them “Wet”**
 2. **Of the remaining 4 specimens; select the specimen with highest air voids and the specimen with the lowest air voids and designate them “Dry”**

(See Next Page)

Resistance of Compacted Asphalt Mixtures to Moisture-Induced Damage

AASHTO Designation: T 283-07

AASHTO TEST METHODS CANNOT BE INCLUDED ON ODOT'S WEBSITE DUE TO COPYRIGHT INFRINGEMENT.

TO GET COPIES OF THE TEST METHODS, YOU MAY ORDER A HARD COPY OF ODOT'S **MANUAL OF FIELD TEST PROCEDURES** OR YOU MAY ORDER THE LATEST **STANDARD SPECIFICATIONS FOR TRANSPORTATION MATERIALS AND METHODS OF SAMPLING AND TESTING** FROM AASHTO.

To order ODOT's *Manual of Field Test Procedures*, use the following web address:

<https://www.oregon.gov/ODOT/Forms/2ODOT/7345110.pdf>

To order AASHTO's *Standard Specifications for Transportation Materials and Methods of Sampling and Testing*, visit the [AASHTO Store website](#).

Test Procedure AASHTO T 308 Continued

- When a separate sample is tested for moisture, then the following equations shall apply:

$$M_{id} = \left\{ \frac{M_i}{1 + \left(\frac{\% M}{100} \right)} \right\}$$

Where: M_i = Initial mass of sample prior to ignition, including moisture.
 $\%M$ = Moisture content of sample based on final dry weight per AASHTO T 329.

$$P_b = \left(\frac{M_{id} - M_f}{M_{id}} \right) \times 100 - C_f$$

Where: M_f = Final mass of aggregate remaining after ignition.
 M_{id} = Initial "Dry" mass of mixture prior to ignition.
 C_f = Correction Factor

- When the sample is oven dried to a constant mass, then the following equation shall apply:

$$P_b = \left(\frac{M_i - M_f}{M_i} \right) \times 100 - C_f$$

Where: M_i = Initial Oven "Dried" mass of mixture prior to ignition.
 M_f = Final mass of aggregate remaining after ignition.
 C_f = Correction Factor

- Delete Annex - Correction Factors. Perform calibration of Ignition Furnace according to ODOT TM 323.



Oregon

Kate Brown, Governor

Department of Transportation

Construction Section
800 Airport Road SE
Salem, OR 97301-4792
Phone: (503) 986-3000
Fax: (503) 986-3096

October 31, 2018

To: All Holders of the Manual of Field Test Procedures

Section: **Test Procedure AASHTO T 308**

The Oregon Department of Transportation has specified method(s) for this Test Procedure. Please observe the following for our projects:

- **Under Test Procedures, Method A and Method B steps 1, when a furnace using Infra-Red elements is used, turn on and warm up the furnace as recommended by the manufacturer before performing a test.**
- **All other requirements of the test procedure apply to the Infra-Red furnace.**
- **For Test Procedure Method A and Method B, external scale measurements taken at approximately the same temperature (+- 10C (25F)) are required for the initial and final mass determinations. Loss from the printed tickets shall not be used.**
- **For Test Procedure Method B, replace step 7, 45 min burn time with 60 minute burn time. Delete steps 10 thru 14.**
- **Compute the percent binder based on the following calculations and conditions:**

(See Next Page)

DETERMINING THE ASPHALT BINDER CONTENT OF ASPHALT MIXTURES BY THE IGNITION METHOD FOP FOR AASHTO T 308

Scope

This procedure covers the determination of asphalt binder content of asphalt mixtures by ignition of the binder in accordance with AASHTO T 308-18.

Overview

The sample is heated in a furnace at 538°C (1000°F) or less; samples may be heated by convection or direct infrared irradiation (IR). The aggregate remaining after burning can be used for sieve analysis using the FOP for AASHTO T 30.

Some agencies allow the use of recycled asphalt mixtures. When using recycled asphalt mixtures, check with the agency for specific correction procedures.

Asphalt binder in the asphalt mixture is ignited in a furnace. Asphalt binder content is calculated as the percentage difference between the initial mass of the asphalt mixture and the mass of the residual aggregate, with the asphalt binder correction factor, and moisture content subtracted. The asphalt binder content is expressed as percent of moisture-free mix mass.

Two methods, A and B, are presented.

Apparatus

Note 1: The apparatus must be calibrated for the specific mix design. See “Correction Factors” at the end of this FOP.

The apparatus for the Methods A and B is the same except that the furnace for Method A requires an internal balance.

- **Ignition Furnace:** A forced-air ignition furnace that heats the specimens by either the convection or direct IR irradiation method. The convection-type furnace must be capable of maintaining the temperature at $538 \pm 5^\circ\text{C}$ ($1000 \pm 9^\circ\text{F}$).

For Method A, the furnace will be equipped with an internal scale thermally isolated from the furnace chamber and accurate to 0.1 g. The scale shall be capable of determining the mass of a 3500 g sample in addition to the sample baskets. A data collection system will be included so that mass can be automatically determined and displayed during the test. The furnace shall have a built-in computer program to calculate the change in mass of the sample baskets and provide for the input of a correction factor for aggregate loss. The furnace shall provide a printed ticket with the initial specimen mass, specimen mass loss, temperature compensation, correction factor, corrected asphalt binder content, test time, and test temperature. The furnace shall provide an audible alarm and indicator light when the sample mass loss does not exceed 0.01 percent of the total sample mass for three consecutive minutes. Perform lift test according to manufacturer’s instructions weekly during use, if applicable.

Note 2: The furnace shall be designed to permit the operator to change the ending mass loss percentage from 0.01 percent to 0.02 percent.

For both Method A and Method B, the furnace chamber dimensions shall be adequate to accommodate a 3500 g sample. The furnace door shall be equipped so that it cannot be opened during the ignition test. A method for reducing furnace emissions shall be provided and the furnace shall be vented so that no emissions escape into the laboratory. The furnace shall have a fan to pull air through the furnace to expedite the test and to eliminate the escape of smoke into the laboratory.

- **Sample Basket Assembly:** consisting of sample basket(s), catch pan, and basket guards. Sample basket(s) will be of appropriate size allowing samples to be thinly spread and allowing air to flow through and around the sample particles. Sets of two or more baskets shall be nested. A catch pan: of sufficient size to hold the sample basket(s) so that aggregate particles and melting asphalt binder falling through the screen mesh are caught. Basket guards will completely enclose the basket and be made of screen mesh, perforated stainless steel plate, or other suitable material.
- Thermometer, or other temperature measuring device, with a temperature range of 10 - 260°C (50-500°F).
- Oven capable of maintaining 110 ±5°C (230 ±9°F).
- Balance or scale: Capacity sufficient for the sample mass and conforming to the requirements of M 231, Class G2.
- **Safety equipment:** Safety glasses or face shield, high temperature gloves, long sleeved jacket, a heat resistant surface capable of withstanding 650°C (1202°F), a protective cage capable of surrounding the sample baskets during the cooling period, and a particle mask for use during removal of the sample from the basket assembly.
- **Miscellaneous equipment:** A pan larger than the sample basket(s) for transferring sample after ignition, spatulas, bowls, and wire brushes.

Sampling

1. Obtain samples of asphalt mixture in accordance with the FOP for AASHTO R 97.
2. Reduce asphalt mixture samples in accordance with the FOP for AASHTO R 47.
3. If the mixture is not sufficiently soft to separate with a spatula or trowel, place it in a large flat pan in an oven at 110 ±5°C (230 ±9°F) until soft enough.
4. Test sample size shall conform to the mass requirement shown in Table 1.

Note 3: When the mass of the test specimen exceeds the capacity of the equipment used or for large samples of fine mixes, the test specimen may be divided into suitable increments, tested, and the results appropriately combined through a weighted average for calculation of the asphalt binder content.

Table 1

Nominal Maximum Aggregate Size* mm (in.)	Minimum Mass Specimen g	Maximum Mass Specimen g
37.5 (1 ½)	4000	4500
25.0 (1)	3000	3500
19.0 (¾)	2000	2500
12.5 (½)	1500	2000
9.5 (¾)	1200	1700
4.75 (No. 4)	1200	1700

* One sieve larger than the first sieve to retain more than 10 percent of the material using an agency specified set of sieves based on cumulative percent retained. Where large gaps in specification sieves exist, intermediate sieve(s) may be inserted to determine nominal maximum size.

Procedure – Method A (Internal Balance)

1. For the convection-type furnace, preheat the ignition furnace to $538 \pm 5^\circ\text{C}$ ($1000 \pm 9^\circ\text{F}$) or to the temperature determined in the “Correction Factor” section, Step 9 of this method. Manually record the furnace temperature (set point) before the initiation of the test if the furnace does not record automatically. For the direct IR irradiation-type furnace, use the same burn profile as used during the correction factor determination.
2. Dry the sample to constant mass, according to the FOP for AASHTO T 329; or determine the moisture content of a companion sample in accordance with the FOP for AASHTO T 329.
3. Determine and record the mass to the nearest 0.1 g of the sample basket assembly.
4. Evenly distribute the sample in the sample basket assembly, taking care to keep the material away from the edges of the basket. Use a spatula or trowel to level the sample.
5. Determine and record the total mass of the sample and sample basket assembly at room temperature to the nearest 0.1 g. Calculate and record the initial mass of the sample (total mass minus the mass of the sample basket assembly) to the nearest 0.1 g. Designate this mass as (M_i).
6. Record the correction factor or input into the furnace controller for the specific asphalt mixture.
7. Input the initial mass of the sample (M_i) into the ignition furnace controller. Verify that the correct mass has been entered.
8. Verify the furnace scale is reading zero, if not, reset to zero.

CAUTION: Operator should wear safety equipment – high temperature gloves, face shield, fire-retardant shop coat – when opening the door to load or unload the sample.

9. Open the chamber door and gently set the sample basket assembly in the furnace. Carefully position the sample basket assembly so it is not in contact with the furnace wall. Close the chamber door and verify that the sample mass displayed on the furnace scale equals the total mass of the sample and sample basket assembly recorded in Step 5 within ± 5 g.

Note 4: Furnace temperature will drop below the set point when the door is opened but will recover when the door is closed, and ignition begins. Sample ignition typically increases the temperature well above the set point – relative to sample size and asphalt binder content.

10. Initiate the test by pressing the start button. This will lock the sample chamber and start the combustion blower.

Safety note: Do not attempt to open the furnace door until the asphalt binder has been completely burned off.

11. Allow the test to continue until the stable light and audible stable indicator indicate that the change in mass does not exceed 0.01 percent for three consecutive minutes. Press the stop button. This will unlock the sample chamber and cause the printer to print out the test results.

Note 5: An ending mass loss percentage of 0.02 may be used, if allowed by the agency, when aggregate that exhibits an excessive amount of loss during ignition testing is used.

12. Open the chamber door, remove the sample basket assembly, and place on the cooling plate or block. Place the protective cage over the sample basket assembly and allow it to cool to room temperature (approximately 30 minutes).
13. Determine and record the total after ignition mass to the nearest 0.1 g. Calculate and record the mass of the sample, after ignition (total after ignition mass minus the mass of the sample basket assembly) to the nearest 0.1 g. Designate this mass as M_f .
14. Use the asphalt binder content percentage from the printed ticket. Subtract the moisture content and the correction factor if not entered into the furnace controller from the printed ticket asphalt binder content and report the difference as the corrected asphalt binder content.

Asphalt binder content percentage can also be calculated using the formula from “Method B” Step 16.

Calculation

Corrected asphalt binder content:

$$P_b = BC - MC - C_f^*$$

*If correction factor is not entered into the furnace controller

where:

P_b = the corrected asphalt binder content as a percent by mass of the asphalt mixture

BC = asphalt binder content shown on printed ticket

MC = moisture content of the companion asphalt mixture sample, percent, as determined by the FOP for AASHTO T 329 (if the specimen was oven-dried before initiating the procedure, MC=0)

C_f = correction factor as a percent by mass of the asphalt mixture sample

Procedure – Method B (External Balance)

1. Preheat the ignition furnace to $538 \pm 5^\circ\text{C}$ ($1000 \pm 9^\circ\text{F}$) or to the temperature determined in the “Correction Factor” section, Step 9 of this method. Manually record the furnace temperature (set point) before the initiation of the test if the furnace does not record automatically.
2. Dry the sample to constant mass, according to the FOP for AASHTO T 329; or determine the moisture content of a companion sample in accordance with the FOP for AASHTO T 329.
3. Determine and record the mass of the sample basket assembly to the nearest 0.1 g.
4. Place the sample basket(s) in the catch pan. Evenly distribute the sample in the sample basket(s), taking care to keep the material away from the edges of the basket. Use a spatula or trowel to level the sample.
5. Determine and record the total mass of the sample and sample basket assembly at room temperature to the nearest 0.1 g. Calculate and record the initial mass of the sample (total mass minus the mass of the sample basket assembly) to the nearest 0.1 g. Designate this mass as (M_i).
6. Record the correction factor for the specific asphalt mixture.
7. Open the chamber door and gently set the sample basket assembly in the furnace. Carefully position the sample basket assembly so it is not in contact with the furnace wall. Burn the asphalt mixture sample in the furnace for 45 minutes or the length of time determined in the “Correction Factors” section.

8. Open the chamber door, remove the sample basket assembly, and place on the cooling plate or block. Place the protective cage over the sample and allow it to cool to room temperature (approximately 30 min).
9. Determine and record the total after ignition mass to the nearest 0.1 g. Calculate and record the mass of the sample, after ignition (total after ignition mass minus the mass of the sample basket assembly) to the nearest 0.1 g.
10. Place the sample basket assembly back into the furnace.
11. Burn the sample for at least 15 minutes after the furnace reaches the set temperature.
12. Open the chamber door, remove the sample basket assembly, and place on the cooling plate or block. Place the protective cage over the sample basket assembly and allow it to cool to room temperature (approximately 30 min.).
13. Determine and record the total after ignition mass to the nearest 0.1 g. Calculate and record the mass of the sample, after ignition (total after ignition mass minus the mass of the sample basket assembly) to the nearest 0.1 g.
14. Repeat Steps 10 through 13 until the change in measured mass of the sample after ignition does not exceed 0.01 percent of the previous sample mass after ignition.
Note 6: An ending mass loss percentage of 0.02 may be used, if allowed by the agency, when aggregate that exhibits an excessive amount of loss during ignition testing is used.
15. Determine and record the total after ignition mass to the nearest 0.1 g. Calculate and record the mass of the sample, after ignition (total after ignition mass minus the mass of the sample basket assembly) to the nearest 0.1 g. Designate this mass as M_f .
16. Calculate the asphalt binder content of the sample.

Calculations

Calculate the asphalt binder content of the sample as follows:

$$P_b = \frac{M_i - M_f}{M_i} \times 100 - MC - C_f$$

where:

- P_b = the corrected asphalt binder content as a percent by mass of the asphalt mixture sample
- M_f = the final mass of aggregate remaining after ignition, g
- M_i = the initial mass of the asphalt mixture sample before ignition, g
- MC = moisture content of the companion asphalt mixture sample, percent, as determined by the FOP for AASHTO T 329 (if the specimen was oven-dried before initiating the procedure, MC = 0).
- C_f = correction factor as a percent by mass of the asphalt mixture sample

Example

Correction Factor	= 0.42%
Moisture Content	= 0.04%
Initial Mass of Sample and Basket	= 5292.7 g
Mass of Basket Assembly	= 2931.5 g
M_i	= 2361.2 g
Total Mass after First ignition + basket	= 5154.4 g
Sample Mass after First ignition	= 2222.9 g
Sample Mass after additional 15 min ignition	= 2222.7 g

$$\%change = \frac{2222.9\text{ g} - 2222.7\text{ g}}{2222.9\text{ g}} \times 100 = 0.009\%$$

%change is not greater than 0.01 percent, so $M_f = 2222.7\text{ g}$

$$P_b = \frac{2361.2\text{ g} - 2222.7\text{ g}}{2361.2\text{ g}} \times 100 - 0.42\% - 0.04\% = 5.41\%$$

$P_b = 5.41\%$

Gradation

1. Empty contents of the basket(s) into a flat pan, being careful to capture all material. Use a small wire brush to ensure all residual fines are removed from the baskets.

Note 7: Particle masks are a recommended safety precaution.

2. Perform the gradation analysis in accordance with the FOP for AASHTO T 30.

Report

- On forms approved by the agency
- Sample ID
- Method of test (A or B)
- Corrected asphalt binder content, P_b , per agency standard
- Correction factor, C_f , to the nearest 0.01 percent
- Temperature compensation factor (Method A only)
- Total percent loss
- Sample mass
- Moisture content to the nearest 0.01%
- Test temperature

Attach the original printed ticket with all intermediate values (continuous tape) to the report for furnaces with internal balances.

ANNEX – CORRECTION FACTORS

ASPHALT BINDER AND AGGREGATE

(Mandatory Information)

Asphalt binder content results may be affected by the type of aggregate in the mixture and by the ignition furnace. Asphalt binder and aggregate correction factors must, therefore, be established by testing a set of correction specimens for each Job Mix Formula (JMF) mix design. Each ignition furnace will have its own unique correction factor determined in the location where testing will be performed.

This procedure must be performed before any acceptance testing is completed, and repeated each time there is a change in the mix ingredients or design. Any changes greater than 5 percent in stockpiled aggregate proportions should require a new correction factor.

All correction samples will be prepared by a central / regional laboratory unless otherwise directed.

Asphalt binder correction factor: A correction factor must be established by testing a set of correction specimens for each Job Mix Formula (JMF). Certain aggregate types may result in unusually high correction factors (> 1.00 percent). Such mixes should be corrected and tested at a lower temperature as described below.

Aggregate correction factor: Due to potential aggregate breakdown during the ignition process, a correction factor will need to be determined for the following conditions:

- a. Aggregates that have a proven history of excessive breakdown
- b. Aggregate from an unknown source.

This correction factor will be used to adjust the acceptance gradation test results obtained according to the FOP for AASHTO T 30.

Procedure

1. Obtain samples of aggregate in accordance with the FOP for AASHTO R 90.
2. Obtain samples of asphalt binder in accordance with the FOP for AASHTO R 66.
Note 8: Include other additives that may be required by the JMF.
3. Prepare an initial, or “butter,” mix at the design asphalt binder content. Mix and discard the butter mix before mixing any of the correction specimens to ensure accurate asphalt content.
4. Prepare two correction specimens at the JMF design asphalt binder content. Aggregate used for correction specimens shall be sampled from material designated for use on the project. An agency approved method will be used to combine aggregate. An additional “blank” specimen shall be batched and tested for aggregate gradation in accordance with the FOP for AASHTO T 30. The gradation from the “blank” shall fall within the agency specified mix design tolerances.
5. Place the freshly mixed specimens directly into the sample basket assembly. If mixed specimens are allowed to cool before placement in the sample basket assembly, the

specimens must be dried to constant mass according to the FOP for AASHTO T 329. Do not preheat the sample basket assembly.

6. Test the specimens in accordance with Method A or Method B of the procedure.
7. Once both of the correction specimens have been burned, determine the asphalt binder content for each specimen by calculation or from the printed ignition furnace tickets, if available.
8. If the difference between the asphalt binder contents of the two specimens exceeds 0.15 percent, repeat with two more specimens and, from the four results, discard the high and low result. Determine the correction factor from the two original or remaining results, as appropriate. Calculate the difference between the actual and measured asphalt binder contents for each specimen to 0.01 percent. The asphalt binder correction factor, C_f , is the average of the differences expressed as a percent by mass of asphalt mixture.
9. If the asphalt binder correction factor exceeds 1.00 percent, the test temperature must be lowered to $482 \pm 5^\circ\text{C}$ ($900 \pm 9^\circ\text{F}$) and new samples must be burned. If the correction factor is the same or higher at the lower temperature, it is permissible to use the higher temperature. The temperature for determining the asphalt binder content of asphalt mixture samples by this procedure shall be the same temperature determined for the correction samples.
10. For the direct IR irradiation-type burn furnaces, the **default** burn profile should be used for most materials. The operator may select burn-profile Option 1 or Option 2 to optimize the burn cycle. The burn profile for testing asphalt mixture samples shall be the same burn profile selected for correction samples.
 - Option 1** is designed for aggregate that requires a large asphalt binder correction factor (greater than 1.00 percent) – typically very soft aggregate (such as dolomite).
 - Option 2** is designed for samples that may not burn completely using the **default** burn profile.
11. Perform a gradation analysis on the residual aggregate in accordance with the FOP for AASHTO T 30, if required. The results will be utilized in developing an “Aggregate Correction Factor” and should be calculated and reported to 0.1 percent.
12. From the gradation results subtract the percent passing for each sieve, for each sample, from the percent passing each sieve of the “Blank” specimen gradation results from Step 4.
13. Determine the average difference of the two values. If the difference for any single sieve exceeds the allowable difference of that sieve as listed in Table 2, then aggregate gradation correction factors (equal to the resultant average differences) for all sieves shall be applied to all acceptance gradation test results determined by the FOP for AASHTO T 30. If the 75 μm (No. 200) is the only sieve outside the limits in Table 2, apply the aggregate correction factor to only the 75 μm (No. 200) sieve.

Table 2
Permitted Sieving Difference

Sieve	Allowable Difference
Sizes larger than or equal to 2.36 mm (No.8)	± 5.0%
Sizes larger than to 75 µm (No.200) and smaller than 2.36 mm (No.8)	± 3.0%
Sizes 75 µm (No.200) and smaller	± 0.5%

Examples:

Sieve Size mm (in.)	Correction Factor Blank Sample % Passing	Correction Factor Sample #1 % Passing	Correction Factor Sample #2 % Passing	Difference 1 / 2	Avg. Diff.	Sieves to adjust
19.0 (3/4)	100	100	100	0/0	0.0	
12.5 (1/2)	86.3	87.4	86.4	-1.1/-0.1	-0.6	
9.5 (3/8)	77.4	76.5	78.8	+0.9/-1.4	-0.3	
4.75 (No. 4)	51.5	53.6	55.9	-2.1/-4.4	-3.3	
2.36 (No. 8)	34.7	36.1	37.2	-1.4/-2.5	-2.0	
01.18 (No. 16)	23.3	25.0	23.9	-1.7/-0.6	-1.2	
0.600 (No. 30)	16.4	19.2	18.1	-2.8/-1.7	-2.3	
0.300 (No. 50)	12.0	11.1	12.7	+0.9/-0.7	+0.1	
0.150 (No. 100)	8.1	9.9	6.3	-1.8/+1.8	0.0	
75 µm (No. 200)	5.5	5.9	6.2	-0.4/-0.7	-0.6	- 0.6

In this example, all gradation test results performed on the residual aggregate (FOP for AASHTO T 30) would have an aggregate correction factor applied to the percent passing the 75 µm (No. 200) sieve. The correction factor must be applied because the average difference on the 75 µm (No. 200) sieve is outside the tolerance from Table 2.

In the following example, aggregate correction factors would be applied to each sieve because the average difference on the 4.75 mm (No. 4) is outside the tolerance from Table 2.

Sieve Size mm (in.)	Correction Factor Blank Sample % Passing	Correction Factor Sample #1 % Passing	Correction Factor Sample #2 % Passing	Difference 1 / 2	Avg. Diff.	Sieves to adjust
19.0 (3/4)	100	100	100	0/0	0.0	0.0
12.5 (1/2)	86.3	87.4	86.4	-1.1/-0.1	-0.6	-0.6
9.5 (3/8)	77.4	76.5	78.8	+0.9/-1.4	-0.3	-0.3
4.75 (No. 4)	51.5	55.6	57.9	-4.1/-6.4	-5.3	-5.3
2.36 (No. 8)	34.7	36.1	37.2	-1.4/-2.5	-2.0	-2.0
01.18 (No. 16)	23.3	25.0	23.9	-1.7/-0.6	-1.2	-1.2
0.600 (No. 30)	16.4	19.2	18.1	-2.8/-1.7	-2.3	-2.3
0.300 (No. 50)	12.0	11.1	12.7	+0.9/-0.7	+0.1	+0.1
0.150 (No. 100)	8.1	9.9	6.3	-1.8/+1.8	0.0	0.0
75 μm (No. 200)	5.5	5.9	6.2	-0.4/-0.7	-0.6	-0.6



Oregon

Theodore R. Kulongoski, Governor

Oregon Department of Transportation

Construction Section

800 Airport Road SE

Salem, OR 97301-4798

Telephone (503) 986-3000

FAX (503) 986-3096

DATE: October 15, 2004

TO: All Holders of the Manual of Field Test Procedures

File Code:

SECTION: **Test Procedure AASHTO T 309**

The Oregon Department of Transportation has specified method(s) for this Test Procedure. Please observe the following for our projects:

- **Under Apparatus, Temperature Measuring Device, Metal Immersion Types of Thermometers, meeting the apparatus requirements are acceptable.**

TEMPERATURE OF FRESHLY MIXED PORTLAND CEMENT CONCRETE FOP FOR AASHTO T 309

Scope

This procedure covers the determination of the temperature of freshly mixed Portland Cement Concrete in accordance with AASHTO T 309-20.

Warning—Fresh Hydraulic cementitious mixtures are caustic and may cause chemical burns to skin and tissue upon prolonged exposure.

Apparatus

- Container — The container shall be made of non-absorptive material and large enough to provide at least 75 mm (3 in.) of concrete in all directions around the sensor; concrete cover must also be at least three times the nominal maximum size of the coarse aggregate.
- Temperature measuring device — The temperature measuring device shall be calibrated and capable of measuring the temperature of the freshly mixed concrete to $\pm 0.5^{\circ}\text{C}$ ($\pm 1^{\circ}\text{F}$) throughout the temperature range likely to be encountered. Partial immersion liquid-in-glass thermometers (and possibly other types) shall have a permanent mark to which the device must be immersed without applying a correction factor.
- Reference temperature measuring device — The reference temperature measuring device shall be a thermometric device readable to 0.2°C (0.5°F) that has been verified and calibrated. The calibration certificate or report indicating conformance to the requirements of ASTM E 77 shall be available for inspection.

Calibration of Temperature Measuring Device

Each temperature measuring device shall be verified for accuracy annually and whenever there is a question of accuracy. Calibration shall be performed by comparing readings on the temperature measuring device with another calibrated instrument at two temperatures at least 15°C or 27°F apart.

Sample Locations and Times

The temperature of freshly mixed concrete may be measured in the transporting equipment, in forms, or in sample containers, provided the sensor of the temperature measuring device has at least 75 mm (3 in.) of concrete cover in all direction around it.

Complete the temperature measurement of the freshly mixed concrete within 5 minutes of obtaining the sample.

Procedure

1. Dampen the sample container.
2. Obtain the sample in accordance with the FOP for WAQTC TM 2.
3. Place sensor of the temperature measuring device in the freshly mixed concrete so that it has at least 75 mm (3 in.) of concrete cover in all directions around it.
4. Gently press the concrete in around the sensor of the temperature measuring device at the surface of the concrete so that air cannot reach the sensor.
5. Leave the sensor of the temperature measuring device in the freshly mixed concrete for a minimum of two minutes, or until the temperature reading stabilizes.
6. Complete the temperature measurement of the freshly mixed concrete within 5 minutes of obtaining the sample.
7. Read and record the temperature to the nearest 0.5°C (1°F).

Report

- Results on forms approved by the agency
- Sample ID
- Measured temperature of the freshly mixed concrete to the nearest 0.5°C (1°F)



Oregon

John A. Kitzhaber, M.D., Governor

Department of Transportation

Construction Section
800 Airport Road SE
Salem, OR 97301-4792
Phone: (503) 986-3000
Fax: (503) 986-3096

October 31, 2013

To: All Holders of the Manual of Field Test Procedures

Section: **Test Procedure AASHTO T 310**

The Oregon Department of Transportation has specified method(s) for this Test Procedure. Please observe the following for our projects:

- **ODOT TM-158 shall be satisfied prior to performing AASHTO T 310.**
- **Document results of ODOT TM 158.**
- **Under Calibration add; Comply with ODOT TM 304.**
- **Under Procedure, use Method A.**
- **The backscatter/air-gap ratio method is not allowed on ODOT contracts.**

Earthwork:

- **Steps 11, 12, and 13 are required**
- **Step 12, moisture content other method allowed is AASHTO T 217**

Crushed Processed Aggregate:

- **AASHTO T 272 is not required**
- **Steps 11, 12 & 13 are not required.**

IN-PLACE DENSITY AND MOISTURE CONTENT OF SOIL AND SOIL-AGGREGATE BY NUCLEAR METHODS (SHALLOW DEPTH) FOP FOR AASHTO T 310

Scope

This procedure covers the determination of density, moisture content, and relative compaction of soil, aggregate, and soil-aggregate mixes in accordance with AASHTO T 310-19. This field operating procedure is derived from AASHTO T 310. The nuclear moisture-density gauge is used in the direct transmission mode.

Apparatus

- Nuclear density gauge with the factory matched standard reference block.
- Drive pin, guide/scrapper plate, and hammer for testing in direct transmission mode.
- Transport case for properly shipping and housing the gauge and tools.
- Instruction manual for the specific make and model of gauge.
- Radioactive materials information and calibration packet containing:
 - Daily Standard Count Log.
 - Factory and Laboratory Calibration Data Sheet.
 - Leak Test Certificate.
 - Shippers Declaration for Dangerous Goods.
 - Procedure Memo for Storing, Transporting and Handling Nuclear Testing Equipment.
 - Other radioactive materials documentation as required by local regulatory requirements.
- Sealable containers and utensils for moisture content determinations.

Radiation Safety

This method does not purport to address all of the safety problems associated with its use. This test method involves potentially hazardous materials. The gauge utilizes radioactive materials that may be hazardous to the health of the user unless proper precautions are taken. Users of this gauge must become familiar with the applicable safety procedures and governmental regulations. All operators will be trained in radiation safety prior to operating nuclear density gauges. Some agencies require the use of personal monitoring devices such as a thermoluminescent dosimeter or film badge. Effective instructions together with routine safety procedures such as source leak tests, recording and evaluation of personal monitoring device data, etc., are a recommended part of the operation and storage of this gauge.

Calibration

Calibrate the nuclear gauge as required by the agency. This calibration may be performed by the agency using manufacturer's recommended procedures or by other facilities approved by the agency. Verify or re-establish calibration curves, tables, or equivalent coefficients every 12 months.

Standardization

1. Turn the gauge on and allow it to stabilize (approximately 10 to 20 minutes) prior to standardization. Leave the power on during the day's testing.
2. Standardize the nuclear gauge at the construction site at the start of each day's work and as often as deemed necessary by the operator or agency. Daily variations in standard count shall not exceed the daily variations established by the manufacturer of the gauge. If the daily variations are exceeded after repeating the standardization procedure, the gauge should be repaired and/or recalibrated.
3. Record the standard count for both density and moisture in the Daily Standard Count Log. The exact procedure for standard count is listed in the manufacturer's Operator's Manual.

Note 1: New standard counts may be necessary more than once a day. See agency requirements.

Overview

There are two methods for determining in-place density of soil / soil aggregate mixtures. See agency requirements for method selection.

- Method A Single Direction
- Method B Two Direction

Procedure

1. Select a test location(s) randomly and in accordance with agency requirements. Test sites should be relatively smooth and flat and meet the following conditions:
 - a. At least 10 m (30 ft) away from other sources of radioactivity
 - b. At least 3 m (10 ft) away from large objects
 - c. The test site should be at least 150 mm (6 in.) away from any vertical projection, unless the gauge is corrected for trench wall effect.
2. Remove all loose and disturbed material and remove additional material as necessary to expose the top of the material to be tested.
3. Prepare a flat area sufficient in size to accommodate the gauge. Plane the area to a smooth condition so as to obtain maximum contact between the gauge and the material being tested. For Method B, the flat area must be sufficient to permit rotating the gauge 90 or 180 degrees about the source rod.

4. Fill in surface voids beneath the gauge with fines of the material being tested passing the 4.75 mm (No. 4) sieve or finer. Smooth the surface with the guide plate or other suitable tool. The depth of the filler should not exceed approximately 3 mm (1/8 in.).
5. Make a hole perpendicular to the prepared surface using the guide plate and drive pin. The hole shall be at least 50 mm (2 in.) deeper than the desired source rod depth and shall be aligned such that insertion of the source rod will not cause the gauge to tilt from the plane of the prepared area. Remove the drive pin by pulling straight up and twisting the extraction tool.
6. Place the gauge on the prepared surface so the source rod can enter the hole without disturbing loose material.
7. Lower the source rod into the hole to the desired test depth using the handle and trigger mechanism.
8. Seat the gauge firmly by partially rotating it back and forth about the source rod. Ensure the gauge is seated flush against the surface by pressing down on the gauge corners and making sure that the gauge does not rock.
9. Pull gently on the gauge to bring the side of the source rod nearest to the scaler / detector firmly against the side of the hole.
10. Perform one of the following methods, per agency requirements:
 - a. Method A Single Direction: Take a test consisting of the average of two, one-minute readings, and record both density and moisture data. The two wet density readings should be within 32 kg/m^3 (2.0 lb/ft^3) of each other. The average of the two wet densities and moisture contents will be used to compute dry density.
 - b. Method B Two Direction: Take a one-minute reading and record both density and moisture data. Rotate the gauge 90 or 180 degrees, pivoting it around the source rod. Reseat the gauge by pulling gently on the gauge to bring the side of the source rod nearest to the scaler/detector firmly against the side of the hole and take a one-minute reading. (In trench locations, rotate the gauge 180 degrees for the second test.) Some agencies require multiple one-minute readings in both directions. Analyze the density and moisture data. A valid test consists of wet density readings in both gauge positions that are within 50 kg/m^3 (3.0 lb/ft^3). If the tests do not agree within this limit, move to a new location. The average of the wet density and moisture contents will be used to compute dry density.
11. If required by the agency, obtain a representative sample of the material, 4 kg (9 lb) minimum, from directly beneath the gauge full depth of material tested. This sample will be used to verify moisture content and / or identify the correct density standard. Immediately seal the material to prevent loss of moisture.

The material tested by direct transmission can be approximated by a cylinder of soil approximately 300 mm (12 in.) in diameter directly beneath the centerline of the radioactive source and detector. The height of the cylinder will be approximately the

depth of measurement. When organic material or large aggregate is removed during this operation, disregard the test information, and move to a new test site.

12. To verify the moisture content from the nuclear gauge, determine the moisture content with a representative portion of the material using the FOP for AASHTO T 255/T 265 or other agency approved methods. If the moisture content from the nuclear gauge is within ± 1 percent, the nuclear gauge readings can be accepted. Moisture content verification is gauge and material specific. Retain the remainder of the sample at its original moisture content for a one-point compaction test under the FOP for AASHTO T 272, or for gradation, if required.

Note 2: Example: A gauge reading of 16.8 percent moisture and an oven dry of 17.7 percent are within the ± 1 percent requirement. Moisture correlation curves will be developed according to agency guidelines. These curves should be reviewed and possibly redeveloped every 90 days.

13. Determine the dry density by one of the following.
 - a. From nuclear gauge readings, compute by subtracting the mass (weight) of the water (kg/m^3 or lb/ft^3) from the wet density (kg/m^3 or lb/ft^3) or compute using the percent moisture by dividing wet density from the nuclear gauge by 1 plus the moisture content expressed as a decimal.
 - b. When verification is required and the nuclear gauge readings cannot be accepted, the moisture content is determined by the FOP for AASHTO T 255/T 265 or other agency approved methods. Compute dry density by dividing wet density from the nuclear gauge by 1 plus the moisture content expressed as a decimal.

Percent Compaction

- Percent compaction is determined by comparing the in-place dry density as determined by this procedure to the appropriate agency density standard. For soil or soil-aggregate mixes, these are moisture-density curves developed using the FOP for AASHTO T 99/T 180. When using maximum dry densities from the FOP for AASHTO T 99/T 180 or FOP for AASHTO T 272, it may be necessary to use the Annex in the FOP for T 99/T 180 to determine corrected maximum dry density and optimum moisture content.

For coarse granular materials, the density standard may be density-gradation curves developed using a vibratory method such as AKDOT&PF's ATM 212, ITD's T 74, WSDOT's TM 606, or WFLHD's Humphres.

See appropriate agency policies for use of density standards.

Calculation

Calculate the dry density as follows:

$$\rho_d = \left(\frac{\rho_w}{w + 100} \right) \times 100 \quad \text{or} \quad \rho_d = \frac{\rho_w}{\frac{w}{100} + 1}$$

Where:

ρ_d = Dry density, kg/m³ (lb/ft³)

ρ_w = Wet density, kg/m³ (lb/ft³)

w = Moisture content from the FOP's for AASHTO T 255 / T 265, as a percentage

Calculate percent compaction as follows:

$$\% \text{ Compaction} = \frac{\rho_d}{\text{Agency density standard}} \times 100$$

Where:

ρ_d = Dry density, kg/m³ (lb/ft³)

Agency density standard = Corrected maximum dry density from the FOP from T 99/T 180 Annex

Example:

Wet density readings from gauge: 1948 kg/m³ (121.6 lb/ft³)

1977 kg/m³ (123.4 lb/ft³)

Avg: 1963 kg/m³ (122.5 lb/ft³)

Moisture readings from gauge: 14.2% and 15.4% = Avg 14.8%

Moisture content from the FOP's for AASHTO T 255/ T 265: 15.9%

Moisture content is greater than 1 percent different so the gauge moisture cannot be used.

Calculate the dry density as follows:

$$\rho_d = \left(\frac{1963 \text{ kg/m}^3 \text{ or } 122.5 \text{ lb/ft}^3}{15.9 + 100} \right) \times 100 \text{ or } \rho_d = \frac{1963 \text{ kg/m}^3 \text{ or } 122.5 \text{ lb/ft}^3}{\frac{15.9}{100} + 1}$$

$$= 1694 \text{ kg/m}^3 \text{ or } 105.7 \text{ lb/ft}^3$$

Given:

$$\rho_w = 1963 \text{ kg/m}^3 \text{ or } 122.5 \text{ lb/ft}^3$$

$$w = 15.9\%$$

Calculate percent compaction as follows:

$$\% \text{ Compaction} = \frac{105.7 \text{ lb/ft}^3}{111.3 \text{ lb/ft}^3} \times 100 = 95\%$$

Given:

$$\text{Agency density standard} = 111.3 \text{ lb/ft}^3$$

Report

- On forms approved by the agency
- Sample ID
- Location of test, elevation of surface, and thickness of layer tested
- Visual description of material tested
- Make, model and serial number of the nuclear moisture-density gauge
- Wet density to the nearest 0.1 lb/ft³
- Moisture content as a percent, by mass, of dry soil mass to the nearest 0.1 percent
- Dry density to the nearest 0.1 lb/ft³
- Density standard to the nearest 0.1 lb/ft³
- Percent compaction the nearest 1 percent
- Name and signature of operator

Hamburg Wheel-Track Testing of Compacted Asphalt Mixtures

AASHTO Designation: T 324-19

AASHTO TEST METHODS CANNOT BE INCLUDED ON ODOT'S WEBSITE DUE TO COPYRIGHT INFRINGEMENT.

TO GET COPIES OF THE TEST METHODS, YOU MAY ORDER A HARD COPY OF ODOT'S **MANUAL OF FIELD TEST PROCEDURES** OR YOU MAY ORDER THE LATEST **STANDARD SPECIFICATIONS FOR TRANSPORTATION MATERIALS AND METHODS OF SAMPLING AND TESTING** FROM AASHTO.

To order ODOT's *Manual of Field Test Procedures*, use the following web address:

<https://www.oregon.gov/ODOT/Forms/2ODOT/7345110.pdf>

To order AASHTO's *Standard Specifications for Transportation Materials and Methods of Sampling and Testing*, visit the [AASHTO Store website](#).



Oregon

John A. Kitzhaber, M.D., Governor

Department of Transportation

Construction Section
800 Airport Road SE
Salem, OR 97301-4792
Phone: (503) 986-3000
Fax: (503) 986-3096

November 30, 2012

To: All Holders of the Manual of Field Test Procedures

Section: **Test Procedure AASHTO T 329**

The Oregon Department of Transportation has specified method(s) for this Test Procedure. Please observe the following for our projects:

- **Under test procedure, step 8, delete the $\pm 9^{\circ}\text{C}$ (15°F) reference and replace with $\pm 10^{\circ}\text{C}$ (25°F).**
- **RAP and RAS moisture content shall be determined by this test method.**
- **Report RAP and RAS moisture content to the nearest 0.1%.**

MOISTURE CONTENT OF ASPHALT MIXTURES BY OVEN METHOD FOP FOR AASHTO T 329

Scope

This procedure covers the determination of moisture content of asphalt mixtures in accordance with AASHTO T 329-15.

Overview

Moisture content is determined by comparing the wet mass of a sample and the mass of the sample after drying to constant mass. The term constant mass is used to define when a sample is dry.

Constant mass – the state at which a mass does not change more than a given percent, after additional drying for a defined time interval, at a required temperature.

Apparatus

- Balance or scale: 2 kg capacity, readable to 0.1 g and conforming to AASHTO M 231.
- Forced draft, ventilated, or convection oven: Capable of maintaining the temperature surrounding the sample at $163 \pm 14^{\circ}\text{C}$ ($325 \pm 25^{\circ}\text{F}$).
- Sample Container: Clean, dry, not affected by heat and of sufficient size to contain a test sample without danger of spilling.
- Thermometer or other suitable device with a temperature range of $10\text{-}260^{\circ}\text{C}$ ($50\text{-}500^{\circ}\text{F}$).

Sample

The test sample shall be obtained in accordance with the FOP for AASHTO R 97 and reduced in accordance with the FOP for AASHTO R 47. The size of the test sample shall be a minimum of 1000 g.

Procedure

1. Preheat the oven to the Job Mix Formula (JMF) mixing temperature range. If the mixing temperature is not supplied, a temperature of $163 \pm 14^{\circ}\text{C}$ ($325 \pm 25^{\circ}\text{F}$) is to be used.
2. Determine and record the mass of the sample container, including release media, to the nearest 0.1 g.
Note 1: When using paper or other absorptive material to line the sample container ensure it is dry before determining initial mass of sample container.
3. Place the test sample in the sample container.
4. Determine and record the temperature of the test sample.
5. Determine and record the total mass of the sample container and test sample to the nearest 0.1 g.
6. Calculate the initial, moist mass (M_i) of the test sample by subtracting the mass of the sample container as determined in Step 2 from the total mass of the sample container and the test sample as determined in Step 5.

7. The test sample shall be initially dried for 90 ± 5 minutes, and its mass determined. Then it shall be dried at 30 ± 5 minute intervals until further drying does not alter the mass by more than 0.05 percent.
8. Cool the sample container and test sample to $\pm 9^\circ\text{C}$ ($\pm 15^\circ\text{F}$) of the temperature determined in Step 4.
9. Determine and record the total mass of the sample container and test sample to the nearest 0.1 g.
10. Calculate the final, dry mass (M_f) of the test sample by subtracting the mass of the sample container as determined in Step 2 from the total mass of the sample container and the test sample as determined in Step 9.

Note 2: Moisture content and the number of samples in the oven will affect the rate of drying at any given time. Placing wet samples in the oven with nearly dry samples could affect the drying process.

Calculations

Constant Mass:

Calculate constant mass using the following formula:

$$\% \text{ Change} = \frac{M_p - M_n}{M_p} \times 100$$

Where:

M_p = previous mass measurement

M_n = new mass measurement

Example:

Mass of container:	232.6 g
Mass of container and sample after first drying cycle:	1361.8 g
Mass, M_p , of possibly dry sample:	$1361.8 \text{ g} - 232.6 \text{ g} = 1129.2 \text{ g}$
Mass of container and possibly dry sample after second drying cycle:	1360.4 g
Mass, M_n , of possibly dry sample:	$1360.4 \text{ g} - 232.6 \text{ g} = 1127.8 \text{ g}$

$$\% \text{ Change} = \frac{1129.2 \text{ g} - 1127.8 \text{ g}}{1129.2 \text{ g}} \times 100 = 0.12\%$$

0.12 percent is not less than 0.05 percent, so continue drying the sample.

Mass of container and possibly dry sample after third drying cycle:	1359.9 g
Mass, M_n , of dry sample:	$1359.9 \text{ g} - 232.6 \text{ g} = 1127.3 \text{ g}$

$$\% \text{ Change} = \frac{1127.8 \text{ g} - 1127.3 \text{ g}}{1127.8 \text{ g}} \times 100 = 0.04\%$$

0.04 percent is less than 0.05 percent, so constant mass has been reached.

Moisture Content:

Calculate the moisture content, as a percent, using the following formula.

$$\text{Moisture Content} = \frac{M_i - M_f}{M_f} \times 100$$

Where:

M_i = initial, moist mass

M_f = final, dry mass

Example:

$$M_i = 1134.9 \text{ g}$$

$$M_f = 1127.3 \text{ g}$$

$$\text{Moisture Content} = \frac{1134.9 \text{ g} - 1127.3 \text{ g}}{1127.3 \text{ g}} \times 100 = 0.674, \text{ say } 0.67\%$$

Report

- On forms approved by the agency
- Sample ID
- Moisture content to the nearest 0.01 percent

DETERMINING THE PERCENTAGE OF FRACTURE IN COARSE AGGREGATE FOP FOR AASHTO T 335

Scope

This procedure covers the determination of the percentage, by mass, of a coarse aggregate (CA) sample that consists of fractured particles meeting specified requirements in accordance with AASHTO T 335-09.

In this FOP, a sample of aggregate is screened on the sieve separating CA and fine aggregate (FA). This sieve will be identified in the agency's specifications, but might be the 4.75 mm (No. 4) sieve. CA particles are visually evaluated to determine conformance to the specified fracture. The percentage of conforming particles, by mass, is calculated for comparison to the specifications.

Apparatus

- Balance or scale: Capacity sufficient for the principle sample mass, accurate to 0.1 percent of the sample mass or readable to 0.1 g, and meeting the requirements of AASHTO M 231.
- Sieves: Meeting requirements of the FOP for AASHTO T 27/T 11.
- Splitter: Meeting the requirements of FOP for AASHTO R 76.

Terminology

1. Fractured Face: An angular, rough, or broken surface of an aggregate particle created by crushing or by other means. A face is considered a "fractured face" whenever one-half or more of the projected area, when viewed normal to that face, is fractured with sharp and well-defined edges. This excludes small nicks.
2. Fractured particle: A particle of aggregate having at least the minimum number of fractured faces specified. (This is usually one or two.)

Sampling and Sample Preparation

1. Sample and reduce the aggregate in accordance with the FOPs for AASHTO R 90 and R 76.
2. When the specifications list only a total fracture percentage, the sample shall be prepared in accordance with Method 1. When the specifications require that the fracture be counted and reported on each sieve, the sample shall be prepared in accordance with Method 2.

3. Method 1 - Combined Fracture Determination

- a. Dry the sample sufficiently to obtain a clean separation of FA and CA material in the sieving operation.
- b. Sieve the sample in accordance with the FOP for AASHTO T 27/ T 11 over the 4.75 mm (No. 4) sieve, or the appropriate sieve listed in the agency's specifications for this material.

Note 1: Where necessary, wash the sample over the sieve designated for the determination of fractured particles to remove any remaining fine material, and dry to a constant mass in accordance with the FOP for AASHTO T 255.

- c. Reduce the sample using Method A – Mechanical Splitter, in accordance with the FOP for AASHTO R 76, to the appropriate test size. This test size should be slightly larger than shown in Table 1, to account for loss of fines through washing if necessary.

TABLE 1
Sample Size
Method 1 (Combined Sieve Fracture)

Nominal Maximum Size* mm (in.)	Minimum Cumulative Sample Mass Retained on 4.75 mm (No. 4) Sieve g (lb)
37.5 (1 1/2)	2500 (6)
25.0 (1)	1500 (3.5)
19.0 (3/4)	1000 (2.5)
12.5 (1/2)	700 (1.5)
9.5 (3/8)	400 (0.9)
4.75 (No. 4)	200 (0.4)

* One sieve larger than the first sieve to retain more than 10 percent of the material using an agency specified set of sieves based on cumulative percent retained. Where large gaps in specification sieves exist, intermediate sieve(s) may be inserted to determine nominal maximum size.

4. Method 2 – Individual Sieve Fracture Determination

- a. Dry the sample sufficiently to obtain a clean separation of FA and CA material in the sieving operation. A washed sample from the gradation determination (the FOP for T 27/T 11) may be used.
- b. If not, sieve the sample in accordance with the FOP for AASHTO T 27 over the sieves listed in the specifications for this material.

Note 2: If overload (buffer) sieves are used the material from that sieve must be added to the next specification sieve.

- c. The size of test sample for each sieve shall meet the minimum size shown in Table 2. Utilize the total retained sieve mass or select a representative portion from each sieve mass by splitting or quartering in accordance with the FOP for AASHTO R 76.

Note 3: Where necessary, wash the sample over the sieves designated for the determination of fractured particles to remove any remaining fine material, and dry to a constant mass in accordance with the FOP for AASHTO T 255.

TABLE 2
Sample Size
Method 2 (Individual Sieve Fracture)

Sieve Size mm (in.)	Minimum Sample Mass g (lb)
31.5 (1 1/4)	1500 (3.5)
25.0 (1)	1000 (2.2)
19.0 (3/4)	700 (1.5)
16.0 (5/8)	500 (1.0)
12.5 (1/2)	300 (0.7)
9.5 (3/8)	200 (0.5)
6.3 (1/4)	100 (0.2)
4.75 (No. 4)	100 (0.2)
2.36 (No. 8)	25 (0.1)
2.00 (No. 10)	25 (0.1)

Note 4: If fracture is determined on a sample obtained for gradation, use the mass retained on the individual sieves, even if it is less than the minimum listed in Table 2. If less than 5 percent of the total mass is retained on a single specification sieve, include that material on the next smaller specification sieve. If a smaller specification sieve does not exist, this material shall not be included in the fracture determination.

Procedure

1. After cooling, spread the dried sample on a clean, flat surface.
2. Examine each particle face and determine if the particle meets the fracture criteria.
3. Separate the sample into three categories:
 - Fractured particles meeting the criteria
 - Particles not meeting the criteria
 - Questionable or borderline particles
4. Determine the dry mass of particles in each category to the nearest 0.1 g.
5. Calculate the percent questionable particles.

6. Resort the questionable particles when more than 15 percent is present. Continue sorting until there is no more than 15 percent in the questionable category.
7. Calculate the percent fractured particles meeting criteria to nearest 0.1 percent. Report to 1 percent.

Calculation

Calculate the mass percentage of questionable particles to the nearest 1 percent using the following formula:

$$\%Q = \frac{Q}{F + Q + N} \times 100$$

where:

- %Q = Percent of questionable fractured particles
- F = Mass of fractured particles
- Q = Mass of questionable or borderline particles
- N = Mass of unfractured particles

Example:

$$\%Q = \frac{97.6 \text{ g}}{632.6 \text{ g} + 97.6 \text{ g} + 352.6 \text{ g}} \times 100 = 9.0\%$$

where:

- Mass of fractured particles = 632.6 g
- Mass of questionable particles = 97.6 g
- Mass of unfractured particles = 352.6 g

Calculate the mass percentage of fractured faces to the nearest 0.1 percent using the following formula:

$$P = \frac{\frac{Q}{2} + F}{F + Q + N} \times 100$$

where:

- P = Percent of fracture
- F = Mass of fractured particles
- Q = Mass of questionable particles
- N = Mass of unfractured particles

Example:

$$P = \frac{\frac{97.6 \text{ g}}{2} + 632.6 \text{ g}}{632.6 \text{ g} + 97.6 \text{ g} + 352.6 \text{ g}} \times 100 = 62.9\% \quad \text{Report 63\%}$$

where:

Mass of fractured particles	=	632.6 g,
Mass of questionable particles	=	97.6 g
Mass of unfractured particles	=	352.6 g

Report

- Results on forms approved by the agency
- Sample ID
- Fractured particles to the nearest 1 percent.



Oregon

Kate Brown, Governor

Department of Transportation

Construction Section
800 Airport Road SE
Salem, OR 97301-4792
Phone: (503) 986-3000
Fax: (503) 986-3096

October 31, 2018

To: All Holders of the Manual of Field Test Procedures

Section: **Test Procedure AASHTO T 355**

The Oregon Department of Transportation has specified method(s) for this Test Procedure. Please observe the following for our projects:

- **Under Calibration: ODOT requires calibration verified according to TM 304.**
- **Under Procedure, Step 2, a filler material is defined as material passing the No. 8 or finer sieve and from the aggregate source used to produce the Job Mix Formula.**
- **Under Procedure, use Method A for density determinations. Method B is not allowed.**
- **Delete Appendix – Correlation with Cores**
- **For Core Correlation use ODOT TM-327 and utilize form 734-2327 for reporting.**

Density testing of ACP shall conform to the following:

- **Select 5 longitudinal test locations in a stratified random pattern in accordance with ODOT TM 400.**

IN-PLACE DENSITY OF ASPHALT MIXTURES BY NUCLEAR METHODS FOP FOR AASHTO T 355

Scope

This test method describes a procedure for determining the density of asphalt mixtures by means of a nuclear gauge using the backscatter method in accordance with AASHTO T 355-18. Correlation with densities determined under the FOP for AASHTO T 166 is required by some agencies.

Apparatus

- Nuclear density gauge with the factory-matched standard reference block.
- Transport case for properly shipping and housing the gauge and tools.
- Instruction manual for the specific make and model of gauge.
- Radioactive materials information and calibration packet containing:
 - Daily standard count log
 - Factory and laboratory calibration data sheet
 - Leak test certificate
 - Shippers' declaration for dangerous goods
 - Procedure memo for storing, transporting, and handling nuclear testing equipment
 - Other radioactive materials documentation as required by local regulatory requirements

Material

- Filler material: Fine-graded sand from the source used to produce the asphalt pavement or other agency approved materials.

Radiation Safety

This method does not purport to address all of the safety problems associated with its use. This test method involves potentially hazardous materials. The gauge utilizes radioactive materials that may be hazardous to the health of the user unless proper precautions are taken. Users of this gauge must become familiar with the applicable safety procedures and governmental regulations. All operators will be trained in radiation safety before operating nuclear density gauges. Some agencies require the use of personal monitoring devices such as a thermoluminescent dosimeter or film badge. Effective instructions, together with routine safety procedures such as source leak tests, recording and evaluation of personal monitoring device data, etc., are a recommended part of the operation and storage of this gauge.

Calibration

Calibrate the nuclear gauge as required by the agency. This calibration may be performed by the agency using the manufacturer's recommended procedures or by other facilities approved by the agency. Verify or re-establish calibration curves, tables, or equivalent coefficients every 12 months.

Standardization

1. Turn the gauge on and allow it to stabilize (approximately 10 to 20 minutes) before standardization. Leave the power on during the day's testing.
2. Standardize the nuclear gauge at the construction site at the start of each day's work and as often as deemed necessary by the operator or agency. Daily variations in standard count shall not exceed the daily variations established by the manufacturer of the gauge. If the daily variations are exceeded after repeating the standardization procedure, the gauge should be repaired, recalibrated, or both.
3. Record the standard count for both density and moisture in the daily standard count log. The exact procedure for standard count is listed in the manufacturer's Operator's Manual.

Note 1: New standard counts may be necessary more than once a day. See agency requirements.

Test Site Location

1. Select a test location(s) randomly and in accordance with agency requirements. Test sites should be relatively smooth and flat and meet the following conditions:
 - a. At least 10 m (30 ft.) away from other sources of radioactivity.
 - b. At least 3 m (10 ft.) away from large objects.
 - c. If the gauge will be closer than 600 mm (24 in.) to any vertical mass, or less than 300 mm (12 in.) from a vertical pavement edge, use the gauge manufacturer's correction procedure.

Procedure

1. Maintain maximum contact between the base of the gauge and the surface of the material under test.
2. Use filler material to fill surface voids.
3. Spread a small amount of filler material over the test site surface and distribute it evenly. Strike off the surface with a straightedge (such as a lathe or flat-bar steel) to remove excess material.
4. If using thin-layer mode, enter the anticipated overlay thickness into the gauge.

Note 2: If core correlation is required, entered thickness, anticipated thickness, and nominal core thickness may be required to match.

Method A – Average of two one-minute tests

1. Place the gauge on the test site, perpendicular to the roller passes.
2. Using a crayon (not spray paint), mark the outline or footprint of the gauge.
3. Extend the source rod to the backscatter position.
4. Take a one-minute test and record the wet density reading.
5. Rotate the gauge 90 degrees centered over the original footprint. Mark the outline or footprint of the gauge.
6. Take another one-minute test and record the wet density reading.
7. If the difference between the two one-minute tests is greater than 40 kg/m^3 (2.5 lb/ft^3), retest in both directions. If the difference of the retests is still greater than 40 kg/m^3 (2.5 lb/ft^3) test at 180 and 270 degrees.
8. The density reported for each test site shall be the average of the two individual one-minute wet density readings.

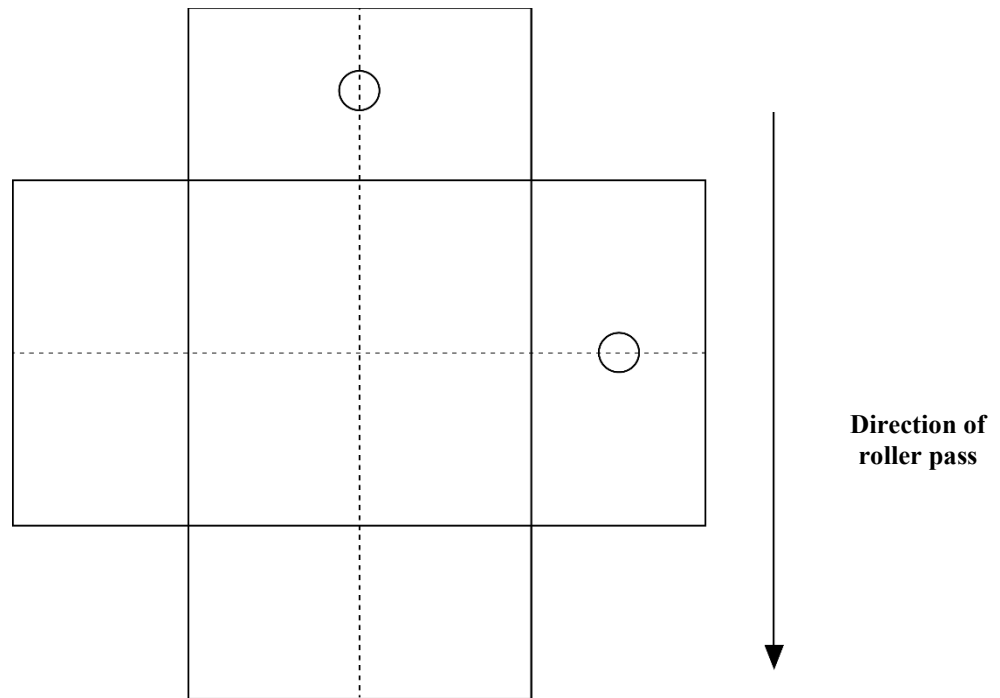

Method A
Footprint of the gauge test site

Method B – One four-minute test

1. Place the gauge on the test site, parallel to the roller passes.
2. Using a crayon (not spray paint), mark the outline or footprint of the gauge.
3. Extend the source rod to the backscatter position.
4. Take one 4-minute test and record the wet density reading.

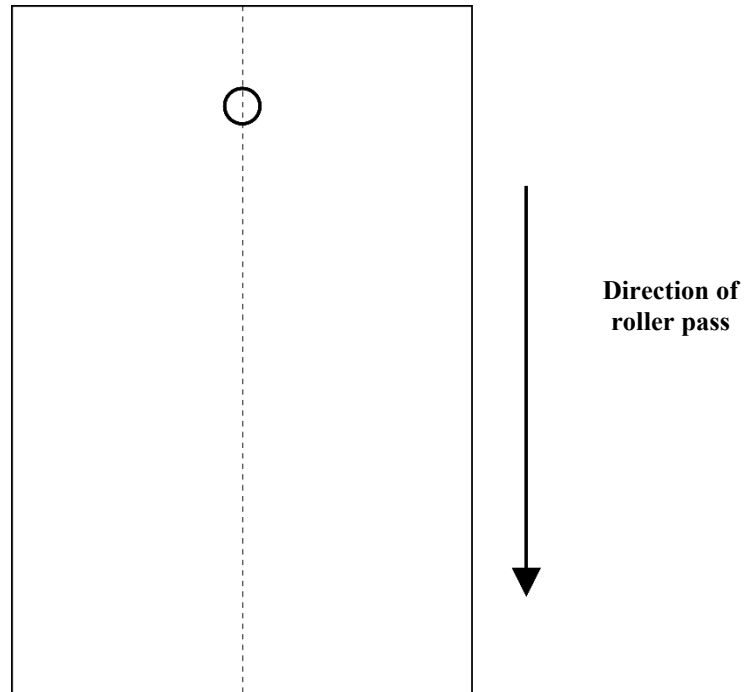

Method B
Footprint of the gauge test site

Calculation of Results

Percent compaction is determined by comparing the in-place wet density as determined by this method to the appropriate agency density standard. See appropriate agency policy for use of density standards.

$$\text{Percent compaction} = \frac{\text{Corrected Reading}}{\text{Maximum Density}} \times 100$$

Method A Example:

Reading #1: 141.5 lb/ft³

Reading #2: 140.1 lb/ft³ Are the two readings within the tolerance? (YES)

Reading average: 140.8 lb/ft³

Core correction: +2.1 lb/ft³

Corrected reading: 142.9 lb/ft³

Method B Example:

Reading: 140.8 lb/ft³

Core correction: +2.1 lb/ft³

Corrected reading 142.9 lb/ft³

Example percent compaction:

From the FOP for AASHTO T 209:

$$G_{mm} = 2.466$$

$$\text{Theoretical Maximum Density} = 2.466 \times 62.245 \text{ lb/ft}^3 = 153.5 \text{ lb/ft}^3$$

$$\text{Percent compaction} = \frac{142.9 \text{ lb/ft}^3}{153.5 \text{ lb/ft}^3} \times 100 = 93.1\%$$

Report

- On forms approved by the agency
- Test ID
- Location of test and thickness of layer tested
- Mixture type
- Make, model and serial number of the nuclear moisture-density gauge
- Calculated wet density of each measurement and any adjustment data
- Density standard
- Compaction to the nearest 0.1 percent
- Name and signature of operator

APPENDIX – CORRELATION WITH CORES

(Nonmandatory Information)

The bulk specific gravity (G_{mb}) of the core is a physical measurement of the in-place asphalt mixture and can be compared with the nuclear density gauge readings. Comparing the core value to the corresponding gauge values, a correlation can be established.

The correlation can then be used to adjust the gauge readings to the in-place density of the cores. The core correlation is gauge specific and must be determined without traffic allowed on the pavement between nuclear density gauge readings and obtaining the core. When using multiple nuclear density gauges each gauge should be correlated to the core locations before removal of the core.

When density correlation with the FOP for AASHTO T 166 is required, correlation of the nuclear gauge with pavement cores shall be made on the first day's paving (within 24 hours) or from a test strip constructed before the start of paving. Cores must be taken before traffic is allowed on the pavement.

Correlation with Cores

1. Determine the number of cores required for correlation from the agency's specifications. Cores shall be located on the first day's paving or on the test strip. Locate the test sites in accordance with the agency's specifications. Follow the "Procedure" section above to establish test sites and obtain densities using the nuclear gauge.
2. Obtain a pavement core from each of the test sites according to AASHTO R 67. The core should be taken from the center of the nuclear gauge footprint.

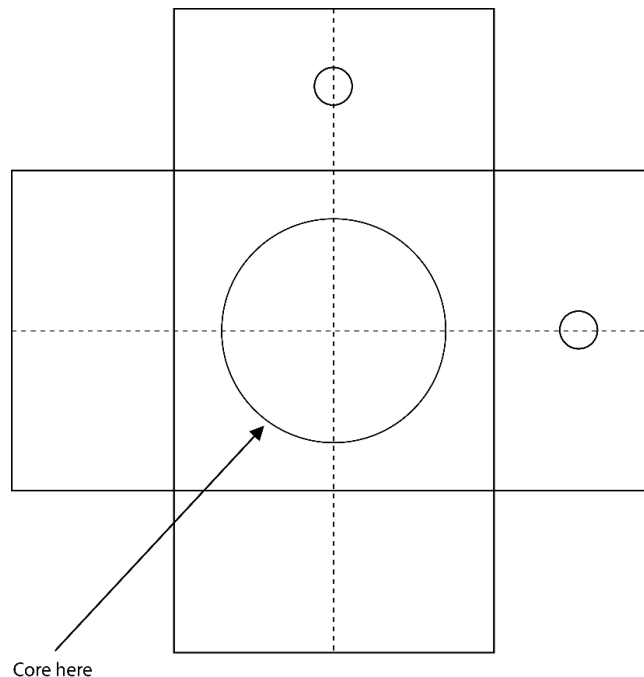

Method A – Footprint of the gauge test site. Core location in the center of the footprint.

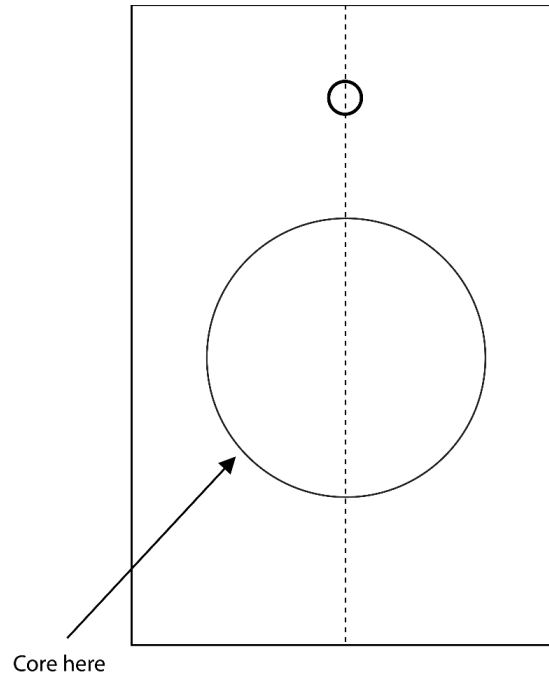

Method B - Footprint of the gauge test site.

3. Determine the density of the cores by the FOP for AASHTO T 166, Bulk Specific Gravity of Compacted Asphalt Mixtures Using Saturated Surface Dry Specimens.
4. Calculate a correlation factor for the nuclear gauge reading as follows:
 - a. Calculate the difference between the core density and the average nuclear gauge density at each test site to the nearest 1 kg/m^3 (0.1 lb/ft^3). Calculate the average difference and standard deviation of the differences for the entire data set to the nearest 1 kg/m^3 (0.1 lb/ft^3).
 - b. If the standard deviation of the differences is equal to or less than 40 kg/m^3 (2.5 lb/ft^3), the correlation factor applied to the average nuclear gauge density shall be the average difference calculated above in 4.a.
 - c. If the standard deviation of the differences is greater than 40 kg/m^3 (2.5 lb/ft^3), the test site with the greatest variation from the average difference shall be eliminated from the data set and the data set properties and correlation factor recalculated following 4.a and 4.b.
 - d. If the standard deviation of the modified data set still exceeds the maximum specified in 4.b, additional test sites will be eliminated from the data set and the data set properties and correlation factor recalculated following 4.a and 4.b. If the data set consists of less than five test sites, additional test sites shall be established.

Note A1: The exact method used in calculating the nuclear gauge correlation factor shall be defined by agency policy.

Note A2: The above correlation procedure must be repeated if there is a new job mix formula. Adjustments to the job mix formula beyond tolerances established in the contract documents will constitute a new

job mix formula. A correlation factor established using this procedure is only valid for the particular gauge used in the correlation procedure. If another gauge is brought onto the project, it shall be correlated using the same procedure. Multiple gauges may be correlated from the same series of cores if done at the same time.

Note A3: For the purpose of this procedure, a job mix formula is defined as the percent and grade of paving asphalt used with a specified gradation of aggregate from a designated aggregate source. A new job mix formula may be required whenever compaction of the wearing surface exceeds the agency's specified maximum density or minimum air voids.

Calculations

Correlation Factor

$$\sqrt{\frac{\sum x^2}{n-1}}$$

Where:

\sum = Sum

x = Difference from the average Difference

n-1 = number of data sets minus 1

Example

Core #	Core results from T 166:	Average Gauge reading	Difference:	x	x ²
1	144.9 lb/ft ³	142.1 lb/ft ³	2.8 lb/ft ³	-0.7	0.49
2	142.8 lb/ft ³	140.9 lb/ft ³	1.9 lb/ft ³	0.2	0.04
3	143.1 lb/ft ³	140.7 lb/ft ³	2.4 lb/ft ³	-0.3	0.09
4	140.7 lb/ft ³	138.9 lb/ft ³	1.8 lb/ft ³	0.3	0.09
5	145.1 lb/ft ³	143.6 lb/ft ³	1.5 lb/ft ³	0.6	0.36
6	144.2 lb/ft ³	142.4 lb/ft ³	1.8 lb/ft ³	0.3	0.09
7	143.8 lb/ft ³	141.3 lb/ft ³	2.5 lb/ft ³	-0.4	0.16
8	142.8 lb/ft ³	139.8 lb/ft ³	3.0 lb/ft ³	0.9	0.81
9	144.8 lb/ft ³	143.3 lb/ft ³	1.5 lb/ft ³	-0.6	0.36
10	143.0 lb/ft ³	141.0 lb/ft ³	2.0 lb/ft ³	-0.1	<u>0.01</u>
Average Difference:			+2.1 lb/ft ³	$\Sigma x^2 = 2.5$	

Number of data sets

$$n - 1 = 10 - 1 = 9$$

Standard deviation

$$\text{standard deviation} = \sqrt{\frac{2.5}{9}} = 0.53$$

Given:

$$\text{Sum of } x^2 = 2.5$$

$$\text{Number of data sets} = 9$$

The standard deviation of 0.53 is less than 2.5 therefore no cores are eliminated. The average difference from all ten cores is used.



Oregon

Kate Brown, Governor

Department of Transportation

Construction Section
800 Airport Road SE
Salem, OR 97301-4792
Phone: (503) 986-3000
Fax: (503) 986-3096

November 30, 2020

To: All Holders of the Manual of Field Test Procedures

Section: **Test Procedure AASHTO R 47**

The Oregon Department of Transportation has specified method(s) for this Test Procedure. Please observe the following for our projects:

- **Under Procedure, Mechanical Splitter Type B (Riffle) Method is not allowed.**
- **Under Procedure, Incremental Method, is not allowed, use the Quartering Method or a combination of the Full Quarter and the Apex Method may be utilized.**

REDUCING SAMPLES OF ASPHALT MIXTURES TO TESTING SIZE FOP FOR AASHTO R 47

Scope

This procedure covers sample reduction of asphalt mixtures to testing size in accordance with AASHTO R 47-19. The reduced portion is to be representative of the original sample.

Apparatus

- Thermostatically controlled oven capable of maintaining a temperature of at least 110°C (230°F) or high enough to heat the material to a pliable condition for splitting.
- Non-contact temperature measuring device.
- Metal spatulas, trowels, metal straightedges, or drywall taping knives, or a combination thereof; for removing asphalt mixture samples from the quartering device, cleaning surfaces used for splitting, etc.
- Square-tipped, flat-bottom scoop, shovel or trowel for mixing asphalt mixture before quartering.
- Miscellaneous equipment including hot plate, non-asbestos heat-resistant gloves or mittens, pans, buckets, and cans.
- Sheeting: Non-stick heavy paper or other material as approved by the agency.
- Agency-approved release agent, free of solvent or petroleum-based material that could affect asphalt binder.
- Mechanical Splitter Type B (Riffle): having a minimum of eight equal-width chutes discharging alternately to each side with a minimum chute width of at least 50 percent larger than the largest particle size. A hopper or straight-edged pan with a width equal to or slightly smaller than the assembly of chutes in the riffle splitter to permit uniform discharge of the asphalt mixture through the chutes without segregation or loss of material. Sample receptacles of sufficient width and capacity to receive the reduced portions of asphalt mixture from the splitter without loss of material.
- Quartering Template: formed in the shape of a cross with equal length sides at right angles to each other. Template shall be manufactured of metal that will withstand heat and use without deforming. The sides of the quartering template should be sized so that the length exceeds the diameter of the flattened cone of asphalt mixture by an amount allowing complete separation of the quartered sample. Height of the sides must exceed the thickness of the flattened cone of asphalt mixture.
- Non-stick mixing surface that is hard, heat-resistant, clean, level, and large enough to permit asphalt mixture samples to be mixed without contamination or loss of material.

Sampling

Obtain samples according to the FOP for AASHTO R 97.

Sample Preparation

The sample must be warm enough to separate. If not, warm in an oven until it is sufficiently soft to mix and separate easily. Do not exceed either the temperature or time limits specified in the test method(s) to be performed.

Selection of Procedure (Method)

Refer to agency requirements when determining the appropriate method(s) of sample reduction. In general, the selection of a particular method to reduce a sample depends on the initial size of the sample vs. the size of the sample needed for the specific test to be performed. It is recommended that, for large amounts of material, the initial reduction be performed using a mechanical splitter. This decreases the time needed for reduction and minimizes temperature loss. Further reduction of the remaining asphalt mixture may be performed by a combination of the following methods, as approved by the agency. The methods for reduction are:

- Mechanical Splitter Type B (Riffle) Method
- Quartering Method
 - Full Quartering
 - By Apex
- Incremental Method

Procedure

When heating of the equipment is desired, it shall be heated to a temperature not to exceed the maximum mixing temperature of the job mix formula (JMF).

Mechanical Splitter Type B (Riffle) Method

1. Clean the splitter and apply a light coating of approved release agent to the surfaces that will come in contact with asphalt mixture (hopper or straight-edged pan, chutes, receptacles).
2. Place two empty receptacles under the splitter.
3. Carefully empty the asphalt mixture from the agency-approved container(s) into the hopper or straight-edged pan without loss of material. Uniformly distribute from side to side of the hopper or pan.
4. Discharge the asphalt mixture at a uniform rate, allowing it to flow freely through the chutes.
5. Any asphalt mixture that is retained on the surface of the splitter shall be removed and placed into the appropriate receptacle.
6. Reduce the remaining asphalt mixture as needed by this method or a combination of the following methods as approved by the agency.

7. Using one of the two receptacles containing asphalt mixture, repeat the reduction process until the asphalt mixture contained in one of the two receptacles is the appropriate size for the required test.
8. After each split, remember to clean the splitter hopper and chute surfaces if needed.
9. Retain and properly identify the remaining unused asphalt mixture sample for further testing if required by the agency.

Quartering Method

1. If needed, apply a light coating of release agent to quartering template.
2. Dump the sample from the agency approved container(s) into a conical pile on a hard, “non-stick,” clean, level surface where there will be neither a loss of material nor the accidental addition of foreign material. The surface can be made non-stick by the application of an approved asphalt release agent, or sheeting.
3. Mix the material thoroughly by turning the entire sample over a minimum of four times with a flat-bottom scoop; or by alternately lifting each corner of the sheeting and pulling it over the sample diagonally toward the opposite corner, causing the material to be rolled. Create a conical pile by either depositing each scoop or shovelful of the last turning on top of the preceding one or lifting both opposite corners.
4. Flatten the conical pile to a uniform diameter and thickness where the diameter is four to eight times the thickness. Make a visual observation to ensure that the material is homogeneous.
5. Divide the flattened cone into four equal quarters using the quartering template or straightedges assuring complete separation.
6. Reduce to appropriate sample mass by full quartering or by apex.

Full Quartering

- a. Remove diagonally opposite quarters, including all of the fine material, and place in a container to be retained.
- b. Remove the quartering template, if used.
- c. Combine the remaining quarters.
- d. If further reduction is necessary, repeat Quartering Method Steps 3 through 6.
- e. Repeat until appropriate sample mass is obtained. The final sample must consist of the two remaining diagonally opposite quarters.
- f. Retain and properly identify the remaining unused portion of the asphalt mixture sample for further testing if required by the agency.

Reducing by Apex

- a. Using a straightedge, slice through a quarter of the asphalt mixture from the center point to the outer edge of the quarter.
- b. Pull or drag the material from the quarter with two straight edges or hold one edge of the straightedge in contact with quartering device.
- c. Remove an equal portion from the diagonally opposite quarter and combine these increments to create the appropriate sample mass.
- d. Continue using the apex method with the unused portion of the asphalt mixture until samples have been obtained for all required tests.
- e. Retain and properly identify the remaining unused portion of the asphalt mixture sample for further testing if required by the agency.

Incremental Method

1. Cover a hard, clean, level surface with sheeting. This surface shall be large enough that there will be neither a loss of material nor the accidental addition of foreign material.
2. Place the sample from the agency approved container(s) into a conical pile on that surface.
3. Mix the material thoroughly by turning the entire sample over a minimum of four times:
 - a. Use a flat-bottom scoop; or
 - b. Alternately lift each corner of the sheeting and pull it over the sample diagonally toward the opposite corner, causing the material to be rolled.
4. Create a conical pile by either depositing each scoop or shovelful of the last turning on top of the preceding one or lifting both opposite corners.
5. Grasp the sheeting and roll the conical pile into a cylinder (loaf), then flatten the top. Make a visual observation to determine that the material is homogenous.
6. Remove one quarter of the length of the loaf and place in a container to be saved; by either:
 - a. Pull sheeting over edge of counter and drop material into container.
 - b. Use a straightedge at least as wide as the full loaf to slice off material and place into container.
7. Obtain an appropriate sample mass for the test to be performed; by either:
 - a. Pull sheeting over edge of counter and drop cross sections of the material into container until proper sample mass has been obtained.
 - b. Use a straightedge at least as wide as the full loaf to slice off cross sections of the material until proper sample mass has been obtained and place into container.

Note 1: When reducing the sample to test size it is advisable to take several small increments, determining the mass each time until the proper minimum size is achieved. Unless the sample size is grossly in excess of the minimum or exceeds the maximum test size, use the sample as reduced for the test.

8. Repeat Step 7 until all the samples for testing have been obtained or until final quarter of the original loaf is reached.
9. Retain and properly identify the remaining unused portion of the asphalt mixture sample for further testing if required by the agency.



Oregon

Kate Brown, Governor

Department of Transportation

Construction Section
800 Airport Road SE
Salem, OR 97301-4792
Phone: (503) 986-3000
Fax: (503) 986-3096

November 30, 2015

To: All Holders of the Manual of Field Test Procedures

Section: **Test Procedure AASHTO R 66**

The Oregon Department of Transportation has specified method(s) for this Test Procedure. Please observe the following for our projects:

- **Under Procedure, step 3 first bullet, delete the following from the sentence: “or from the delivery truck”. Sampling from the oil delivery truck is not allowed.**
- **Sample asphalt binder at the plant using an in-line sampling device or samples may be obtained from the storage tank, according to AASHTO R 66-15 procedure, section 7.1.1 and 7.2, when mechanical or other circumstances temporarily prohibit the use of the in-line device. Sampling from the storage tank is only permitted to complete the production shift.**

SAMPLING ASPHALT MATERIALS FOP FOR AASHTO R 66

Scope

This procedure covers obtaining samples of liquid asphalt materials in accordance with AASHTO R 66-16. Sampling of solid and semi-solid asphalt materials – included in AASHTO R 66 – is not covered here.

Agencies may be more specific on exactly who samples, where to sample, and what type of sampling device to use.

Warning: Always use appropriate safety equipment and precautions for hot liquids.

Terminology

- Asphalt binder: Asphalt cement or modified asphalt cement that binds the aggregate particles into a dense mass.
- Asphalt emulsion: A mixture of asphalt binder and water.
- Cutback asphalt: Asphalt binder that has been modified by blending with a chemical solvent.

Containers

Sample containers must be new, and the inside may not be washed or rinsed. The outside may be wiped with a clean, dry cloth.

All samples shall be put in 1 L (1 qt) containers and properly identified on the outside of the container with contract number, date sampled, data sheet number, brand and grade of material, and sample number. Include lot and subplot numbers when appropriate.

- Emulsified asphalt: Use wide-mouth plastic jars with screw caps. Protect the samples from freezing since water is a part of the emulsion. The sample container should be completely filled to minimize a skin formation on the sample.
- Asphalt binder and cutbacks: Use metal cans.

Note: The sample container shall not be submerged in solvent, nor shall it be wiped with a solvent saturated cloth. If cleaning is necessary, use a clean dry cloth.

Procedure

1. Coordinate sampling with contractor or supplier.
2. Allow a minimum of 4 L (1 gal) to flow before obtaining a sample(s).
3. Obtain samples of:
 - Asphalt binder from the line between the storage tank and the mixing plant while the plant is in operation, or from the delivery truck.
 - Cutback and emulsified asphalt from distributor spray bar or application device; or from the delivery truck before it is pumped into the distributor. Sample emulsified asphalt at delivery or before dilution.

Report

- On forms approved by the agency
- Sample ID
- Date
- Time
- Location
- Quantity represented



Oregon

Kate Brown, Governor

Department of Transportation

Construction Section
800 Airport Road SE
Salem, OR 97301-4792
Phone: (503) 986-3000
Fax: (503) 986-3096

November 30, 2020

To: All Holders of the Manual of Field Test Procedures

Section: **Test Procedure AASHTO R 67**

The Oregon Department of Transportation has specified method(s) for this Test Procedure. Please observe the following for our projects:

Under the Apparatus Section 4, change or modify as follows:

- **Section 4.2, Core Drill Bit, the core barrel shall have an inside diameter of (6 ± 0.25 in.).**
- **Section 4.3, Separation Equipment, delete and replace with the following:**
Cores lift shall be separated with a saw that provides a clean smooth plane representing the layer to be measured.
- **Section 4.4, Retrieval Device – Removal with a screw driver(s) or similar device shall not be allowed.**

Under Procedure, Step 5.8, delete and replace with the following:

The Hole created from the coring operation shall be filled with fast setting non-shrink grout from the QPL (Qualified Products List). Set time shall be less than 20 minutes. Ensure the final surface is flush with the surrounding surface.

Under the Layer Separation Section 7, delete 7.1 and replace with the following:

Separate the layer of HMAC to be tested from the remainder of each core with a saw. If a clean separation of the desired layer thickness occurs during core removal, sawing of specimen is not necessary. During separation the layer to be tested may be damaged, so use caution during this process.

Standard Practice for

**Sampling Asphalt Mixtures after
Compaction (Obtaining Cores)**

AASHTO Designation: R 67-20¹

Technical Subcommittee: 2c, Asphalt–Aggregate Mixtures

Release: Group 3 (July)



**American Association of State Highway and Transportation Officials
555 12th Street NW, Suite 1000
Washington, D.C. 20004**

Standard Practice for

Sampling Asphalt Mixtures after Compaction (Obtaining Cores)

AASHTO Designation: R 67-20¹



Technical Subcommittee: 2c, Asphalt–Aggregate
Mixtures

Release: Group 3 (July)

1. SCOPE

- 1.1. This method describes the process for removal of a core sample of compacted asphalt mixture from a pavement for laboratory testing. Cores may range in diameter from 2 in. to 12 in.
- 1.2. *This standard does not purport to address all of the safety concerns, if any, associated with its use. It is the responsibility of the user of this standard to establish appropriate safety and health practices and determine the applicability of regulatory limitations prior to use.*
-

2. REFERENCED DOCUMENT

- 2.1. *ASTM Standard:*
- D3549, Standard Test Method for Thickness or Height of Compacted Asphalt Mixture Specimen
-

3. SIGNIFICANCE

- 3.1. Samples obtained in accordance with the procedure may be used for measuring asphalt mixture thickness, density, and other testing.
-

4. APPARATUS

- 4.1. *Core Drilling Machine*—A power-driven core drilling machine shall be used to obtain the sample. The device shall be capable of obtaining a core to the full depth of the asphalt mixture sampled and shall consist of a rigid frame or platform such that the core barrel can be maintained perpendicular to the pavement surface during the drilling process. The core drilling machine must be of sufficient horsepower and have the ability to reach a sufficient depth to minimize distortion of the compacted cores of asphalt mixture.
- 4.2. *Core Drill Bit*—The cutting edge of the core drill bit shall be made of hardened steel or other suitable material with diamond chips embedded in the metal or as recommended by the core drill bit manufacturer in order to drill through the compacted asphalt mixture cleanly. The inside diameter of the core barrel shall be as specified.
-

- 4.3. *Separation Equipment*—A saw or other method(s) that provides a clean, smooth plane representing the layer to be tested without damaging the specimen.
- 4.4. *Retrieval Device*—A device for removing core samples that will preserve the integrity of the core.
Note 1—Suitable devices have been made from steel rods, wire, or banding material.
- 4.5. *Cooling Agent*—Such as water, ice, dry ice, or liquid nitrogen.
- 4.6. *Sample Marking Tool*—A lumber crayon, paint stick, pen, or other suitable marking tool to mark the core sample for labeling, identifying the separation layers, identifying the layer to test, or as otherwise necessary.
- 4.7. *Package Containers*—Suitable packaging containers for securing and transporting the core samples.

5. PROCEDURE

- 5.1. Freshly compacted asphalt mixtures shall be allowed sufficient time to cool prior to coring in order to prevent damage to the core.
Note 2—To accelerate the coring process, compacted asphalt mixtures may be cooled to expedite the removal of the core by the following methods: water, ice, dry ice, or liquid nitrogen.
- 5.2. Provide a means such as water or air to aid in the removal of cuttings and to minimize the generation of heat caused by friction.
- 5.3. Position the coring machine above the selected location. Engage the power and water or air source to the coring machine. Slowly advance the core drill bit until it contacts the compacted asphalt mixture surface.
- 5.4. Keep the core bit perpendicular to the compacted asphalt mixture surface, applying constant pressure during the process.
Note 3—If any portion of the coring machine shifts during the operation, the core may break or distort. Failure to apply constant pressure or applying too much pressure may cause the core drill bit to bind or distort the core.
- 5.5. Continue the core drilling to the bottom or slightly below the bottom of the asphalt mixture intended to be sampled to allow separation of the core sample at the desired depth from the underlying pavement layers.
- 5.6. After drilling, separate the core sample from the underlying pavement layers using the retrieval device or other suitable means, without damaging or distorting the sample. Obtain the core sample using the retrieval device. Carefully brush off, or use water to wash off, any loose particles adhering to the field cores. For field cores taken immediately over a granular base, carefully remove any embedded granular material.
Note 4—If the core is damaged to a point that it cannot be used for its intended purpose, a new core shall be obtained within 6 in. of the original location.
- 5.7. Clearly label the core with a sample marking tool.
- 5.8. Fill the hole made from the coring operation with asphalt mixture, non-shrink grout, or other suitable material. Consolidate or compact the material in the hole in multiple lifts if necessary. Ensure that the final surface is level with the surrounding surface.

6. PACKAGING AND TRANSPORTING SAMPLES

- 6.1. Package core samples in suitable protective containers. If multiple core samples are packaged in one container, separate the samples from one another using a suitable separation material.
Note 5—Concrete cylinder molds and PVC or HDPE pipe have been found to be suitable containers for protecting and transporting core samples. Crumpled newspaper has been found to be a suitable separation material when packaging multiple core samples in one container.
- 6.2. Transport cores in a manner that prevents damage from jarring, rolling, or impact with any object.
- 6.3. Prevent cores from freezing or from excessive heat during transport to prevent breaking or deforming.
Note 6—In extreme ambient temperature conditions, an insulated container should be used during transport.
- 6.4. If the core is damaged in transport to a point it cannot be utilized for its intended purpose, the core will not be used.

7. LAYER SEPARATION

- 7.1. Using appropriate separation equipment, separate two or more pavement courses, lifts, or layers along the designated lift line.
Note 7—Lift lines are often more visible by rolling a wetted core on a flat surface.

8. REPORT

- 8.1. *The report shall include the following:*
- 8.1.1. Date the cores were obtained.
 - 8.1.2. Paving date.
 - 8.1.3. Coring location.
 - 8.1.4. The lift/layer being evaluated.
 - 8.1.5. Average thickness if required.
 - 8.1.6. If known, provide the core identification information, such as the nominal-maximum aggregate size of the mixture, asphalt mixture design identification, performance grade of the asphalt binder, etc.

9. KEYWORDS

- 9.1. Asphalt mixture; core drilling; core sample.

APPENDIXES

(Nonmandatory Information)

X1. THICKNESS DETERMINATION

- X1.1. Measure the thickness of the designated lift according to ASTM D3549/D3549M-11 to the nearest 0.01 ft, $\frac{1}{8}$ in., or 3 mm. Calculate an average of three or more measurements taken around the lift.

X2. PROCEDURE TO REMOVE CUT AGGREGATES FROM ASPHALT PAVEMENT CORES FOR LABORATORY TESTING

X2.1. *Scope*

- X2.1.1. This procedure is used to remove aggregates that have been cut in the core drilling process. This procedure is only necessary in cases where the asphalt pavement core was obtained for the purpose of determining a mixture property that will be affected by the presence of aggregate cut by the coring drill.

X2.2. *Procedure*

- X2.2.1. Place the core(s) in an oven at 230°F for a period between 30 and 60 min. Remove the core(s) when the material is sufficiently softened to easily remove cut aggregate particles according to Section X2.2.2. Cores shall be placed in the vertical position to prevent premature breakdown of the cores. See Figure X1 for an example of vertical versus horizontal placement.



(a) 30 min after oven storage at 230°F

(b) 60 min after oven storage at 230°F

Figure X1—Photographs of Cores Placed in Oven at 230°F

- X2.2.2. Separate cut aggregate particles by any of the following methods: hand, chisel, spatula, trowel, or by pressing a cylindrical tube (with an internal diameter approximately 1 in. less than the diameter of the core) through the core. Dispose of the removed portion of the core.

X2.2.3. The remainder of the core is ready to proceed with the desired testing. Cores consisting of the same pavement layer and obtained from the same roadway section may be combined to meet the requirements of the minimum sample size according to the applicable test method as needed.

X3. REFERENCE

X3.1. D3549/D3549M-11, Standard Test Method for Thickness or Height of Compacted Bituminous Paving Mixture Specimens

¹ This full standard was first published in 2015.



Oregon

Kate Brown, Governor

Department of Transportation

Construction Section
800 Airport Road SE
Salem, OR 97301-4792
Phone: (503) 986-3000
Fax: (503) 986-3096

November 30, 2016

To: All Holders of the Manual of Field Test Procedures

Section: **Test Procedure AASHTO R 75**

The Oregon Department of Transportation has specified method(s) for this Test Procedure. Please observe the following for our projects:

- Supplemental information for Family of Curves Development, Appendix A, is located at the end of R 75.

DEVELOPING A FAMILY OF CURVES FOP FOR AASHTO R 75

Scope

This procedure provides a method to develop a family of curves in accordance with AASHTO R 75-16 using multiple moisture density relationships developed using the same method, A, B, C, or D, from the FOP for AASHTO T 99/T 180.

All curves used in a family must be developed using a single Method: A, B, C, or D of a procedure for AASHTO T 99 or T 180. See the FOP for AASHTO T 99/T 180.

Terminology

family of curves — a group of soil moisture-density relationships (curves) determined using AASHTO T 99 or T 180, which reveal certain similarities and trends characteristic of the soil type and source.

spine — smooth line extending through the point of maximum density/optimum moisture content of a family of moisture-density curves.

Procedure

1. Sort the curves by Method (A, B, C, or D of the FOP for T 99/T 180). At least three curves are required to develop a family.
2. Select the highest and lowest maximum dry densities from those selected to assist in determining the desired scale of the subsequent graph.
3. Plot the maximum density and optimum moisture points of the selected curves on the graph.
4. Draw a smooth, “best fit,” curved line through the points creating the spine of the family of curves.
5. Remove maximum density and optimum moisture points that were not used to establish the spine.
6. Add the moisture/density curves associated with the points that were used to establish the spine. It is not necessary to include the portion of the curves over optimum moisture.

Note 1—Intermediate template curves using slopes similar to those of the original moisture-density curves may be included when maximum density points are more than 2.0 lb/ft³ apart. Template curves are indicated by a dashed line.

7. Plot the 80 percent of optimum moisture range when desired:
 - a. Using the optimum moisture of an existing curve, calculate 80 percent of optimum moisture and plot this value on the curve. Repeat for each curve in the family.
 - b. Draw a smooth, “best fit,” curved line connecting the 80 percent of optimum moisture points plotted on the curves that parallel the spine.

Calculations

Calculate 80 percent of optimum moisture of each curve:

Example:

Optimum moisture of the highest density curve = 14.6%

$$80\% \text{ point} = \frac{80}{100} \times 14.6\% = 11.7\%$$

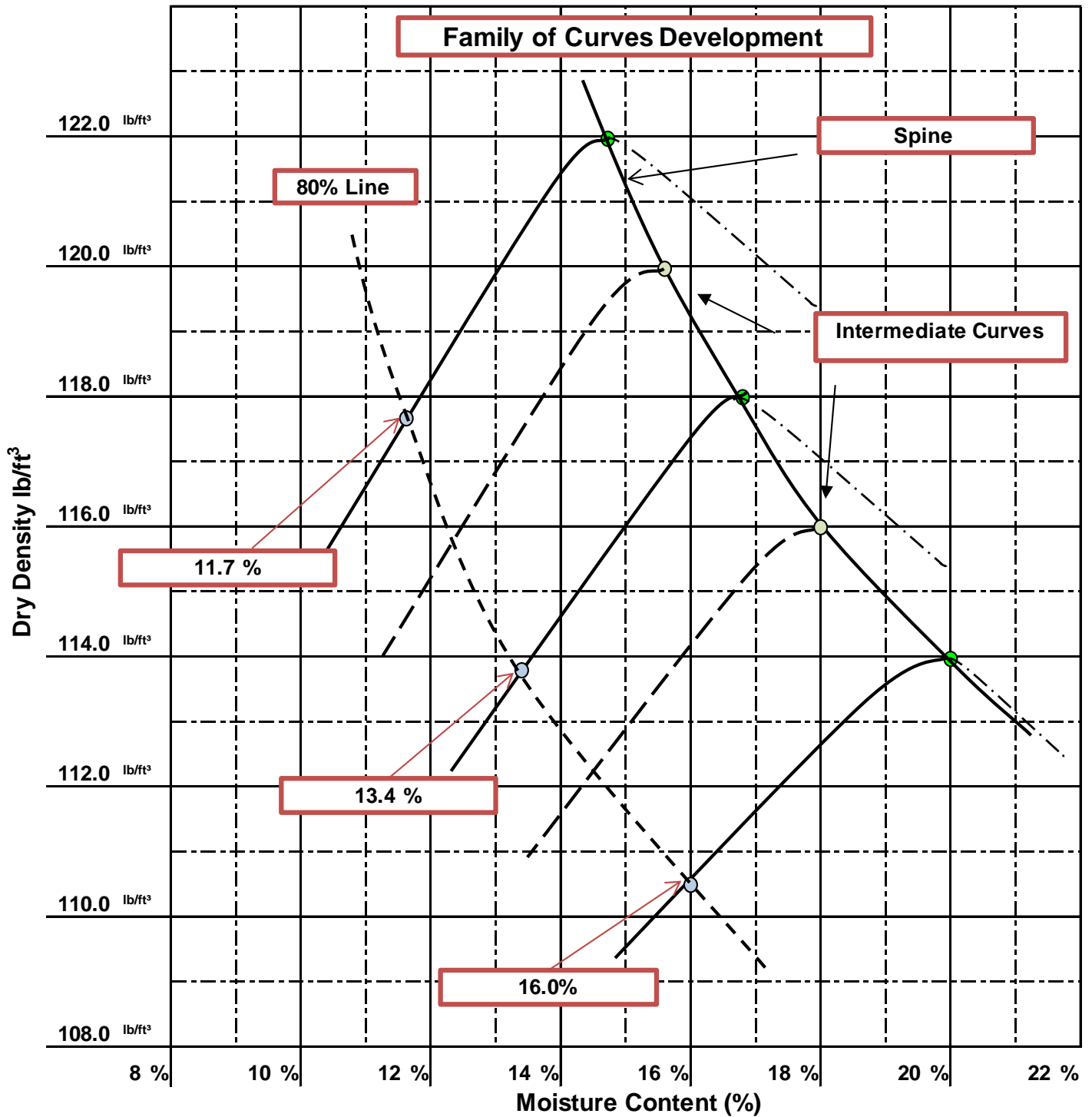

FAMILY OF CURVES – DEVELOPMENT APPENDIX "A" FOP FOR AASHTO R 75

Significance

The purpose of the family of curves is to represent the average moisture-density characteristics of soils with similar geologic makeup. The family should be based on moisture-density relationships which represent the widest possible range of soils which may be encountered on a project. If the soil types have moisture-density relationships that differ considerably and can not be represented on one general family of curves; then multiple families may be developed. Also, moisture-density relationships for material of widely varying geologic origins should be carefully examined to determine if separate families are required.

Soils sampled from one source will have many different moisture-density relationships. If a group of these curves are plotted together, it reveals similarities of the material in relation to the soil type and source. Developing a family of curves has the potential advantage of spanning a large number of different soil types with a minimal amount of laboratory work.

Scope

This procedure provides a process for developing a family of curves using multiple individual curves as the source of data. The individual curves are sorted according to type and plotted on a single sheet of paper. The individual curves are connected by a common line drawn through their maximum density/optimum moisture points forming a family of curves. A series of individual curves or a combination of curves are utilized as appropriate to create one or more families. This procedure is related to AASHTO T 99, and AASHTO T 180. The family of curves must match the method utilized during the single curve development. A minimum of 3 individual curves is required to form a single family.

Apparatus

See the FOP for AASHTO T 99 and T 180.

Sample

See the FOP for AASHTO T 99 and T 180.

Procedure

See the FOP for AASHTO T 99 and T 180.

Calculations

See the FOP for AASHTO T 99 and T 180.

Overview

- Sort the individual curves into groups based on method of development.
- Plot the point representing the maximum density and optimum moisture for each individual curve on a single sheet of graph paper. At least 3 curves are required to develop a family.
- Draw a "best fit" smooth curve which closely connects all points.
- At 2.0 lbs/ft³ increments draw complete moisture-density relationships using slopes closely matching those of the original moisture-density relationships.
- When a large number of similar single curves exists, the average values may be used, if the difference between curves is less than 2.0 lbs/ft³.

Developing a Family of Curves Relationship

1. Initially sort candidate curves by test method and use only those developed using the same procedure.
2. Review the curves and select the highest and lowest maximum dry densities. Select a vertical density scale that places the highest value in the top 1" portion of the graph. Select a dry density increment that places the lowest value approximately 3" from the bottom portion of the graph. Label the incremental areas between the highest and lowest maximum density values.

Note 1: An increment of 2.0 lbs/ft³ per vertical inch is a recommended scale, but any increment can be used to accommodate the data plotting. It is preferable to use a scale that places whole numbers at the bold one-inch gridlines on the graph.

3. Review the corresponding optimum moisture data for the upper and lower points used to establish the vertical dry density scale described in step 2. Select a horizontal moisture scale that places the high point about 3" from the left edge and the low point about 1" from the right edge of the graph. Label the incremental grids between the highest and lowest optimum moisture values.

Note 2: An increment of 2.0% per horizontal inch is a recommended scale, but any increment can be used to accommodate the data plotting. It is preferable to use a scale that places the whole numbers at the bold one-inch gridlines on the graph.

4. Plot the maximum density and optimum moisture for each candidate curve to determine if they fit the desired pattern of a smooth curve that is slightly concave up and to the left. Eliminate points which do not fit this pattern. A minimum of three points is required to establish a family.
5. Draw a smooth "best fit" curve through the points, creating a curve that is slightly concave, up and to the left.

Note 3: The "best fit" curve (or spine) now defines the maximum density and optimum moisture content of the soils represented by this family of curves. A dry density or dry side, reference needs to be established for each individual curve and is created by replicating the original curve shape. Each individual curve has a unique shape towards the maximum density/optimum moisture point and needs to be plotted. This can be accomplished with tracing paper, a French curve or other objects that can mimic the shape. The only useable area on a family of curves is on the "dry" side of optimum moisture, therefore, we only need to apply one half of the moisture-density curve shape configuration to the family of curves spine.

6. Mark each maximum density/optimum moisture point with a dry side arc of sufficient length to meet the dry side leg. This is accomplished by centering the template directly below and touching the maximum density/optimum moisture point. Initially mark lightly in pencil. The exact length of the arc will be determined when the dry side leg is drawn in tangent to this arc. This process is repeated for each original curve.

Note 4: To establish the "dry side" slope a single point near the bottom of the original curve is required. This point, when plotted, will be connected with the tangent on the arc using a straight line. This will complete the original individual curve or the dry half of the original curve. If the scale of the original curve is the same as the family then you should be able to overlay the family with the original curve and when held to the light, the "dry sides" should match. The point selected on the dry side must accurately reflect the slope of the original curve if another scale is utilized. The point selected may be a data point from the original curve or it may be a point scaled off of the graph of the original curve. This process is repeated for each original curve.

7. Establish the 80% of Optimum Moisture Line at the bottom of the "dry side" legs. This provides a graphical guide for the Density Technician when using the family of curves in the field. Compute 80% of optimum moisture for each curve by multiplying the optimum moisture by 0.8. Lay a ruler vertically on the graph and at the 80% of optimum moisture calculated, make a tick mark where the ruler intercepts the "dry side" leg of that curve. This process is repeated for each original curve. Draw a smooth best-fit curve through the tick marks and label each end of the line with 80%.
8. At 2.0 lbs/ft³ increments draw moisture-density relationships using slopes similar to those of the original moisture-density relationships.

EXAMPLE OF FAMILY DEVELOPMENT:

STEP 1:

- Sort and only retain curves developed by the same procedure (e.g. T 99 method A).

STEP 2 & 3:

- Establish and label an appropriate dry density scale on the vertical axis and a percent moisture scale on the horizontal axis.

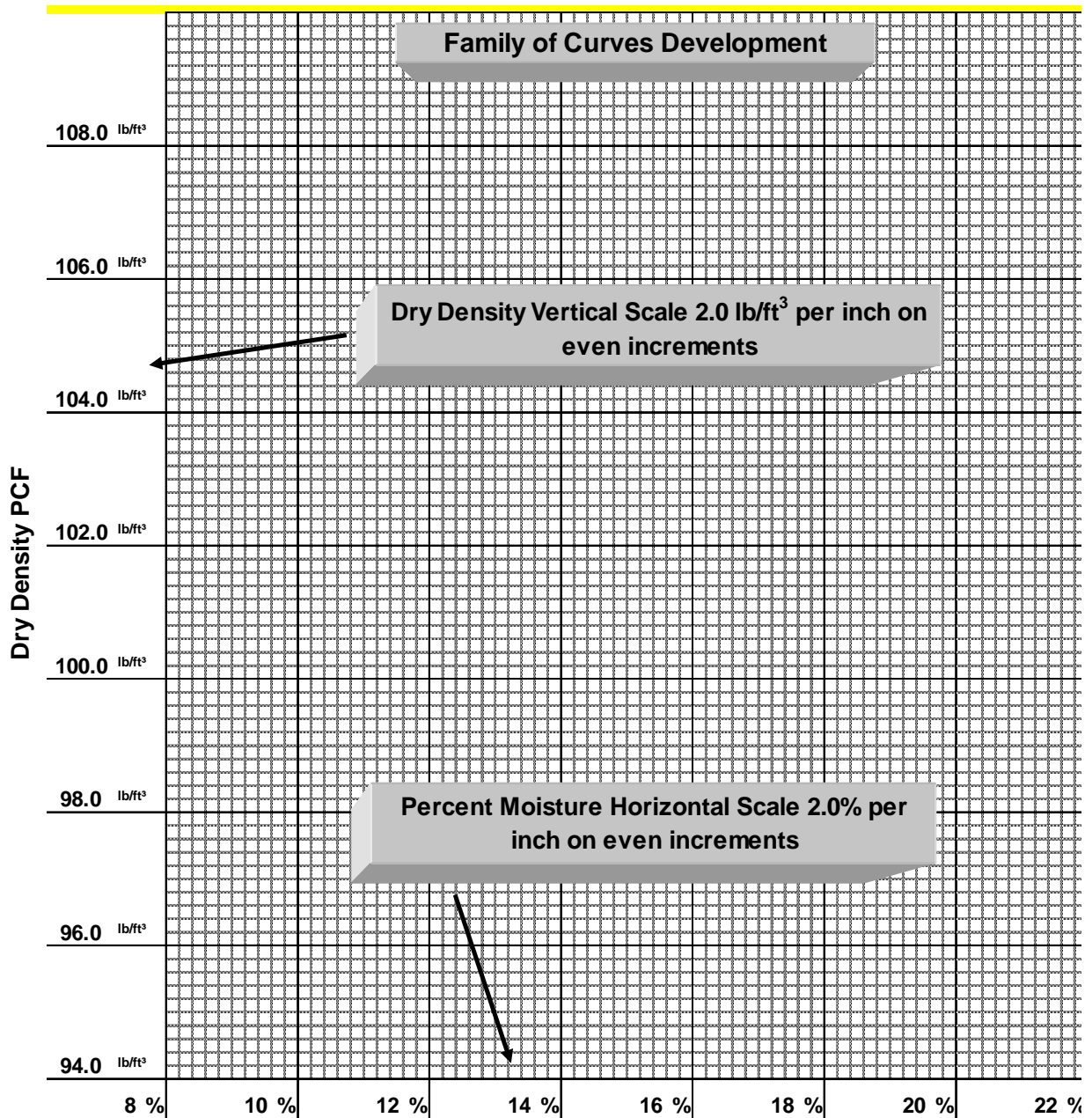

Step 4:

- Plot only the points representing the maximum dry density and optimum moisture from the candidate curves.

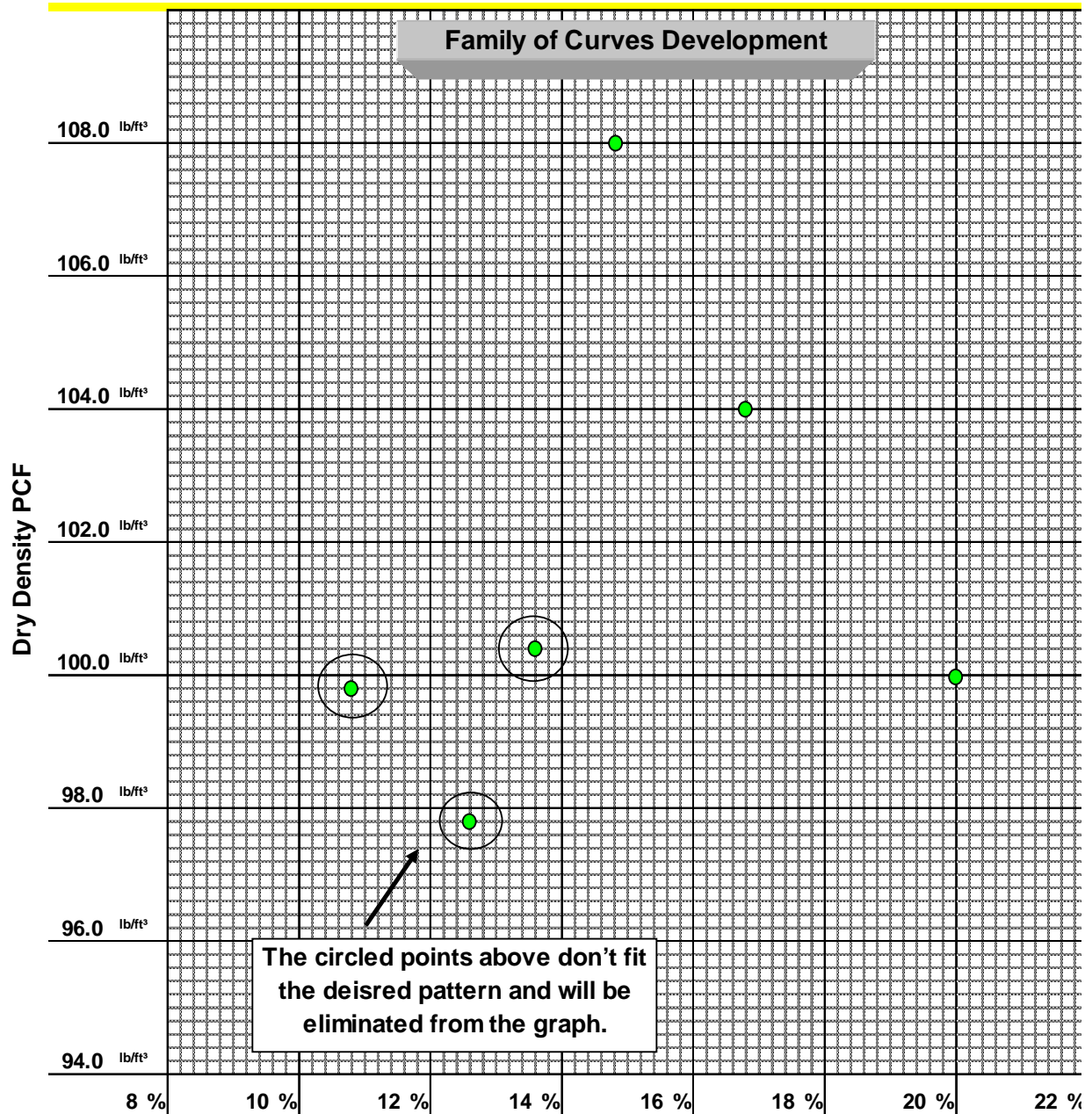

Step 5: Draw a smooth "best fit" curve through the points creating a curve that is slightly concave up and to the left.

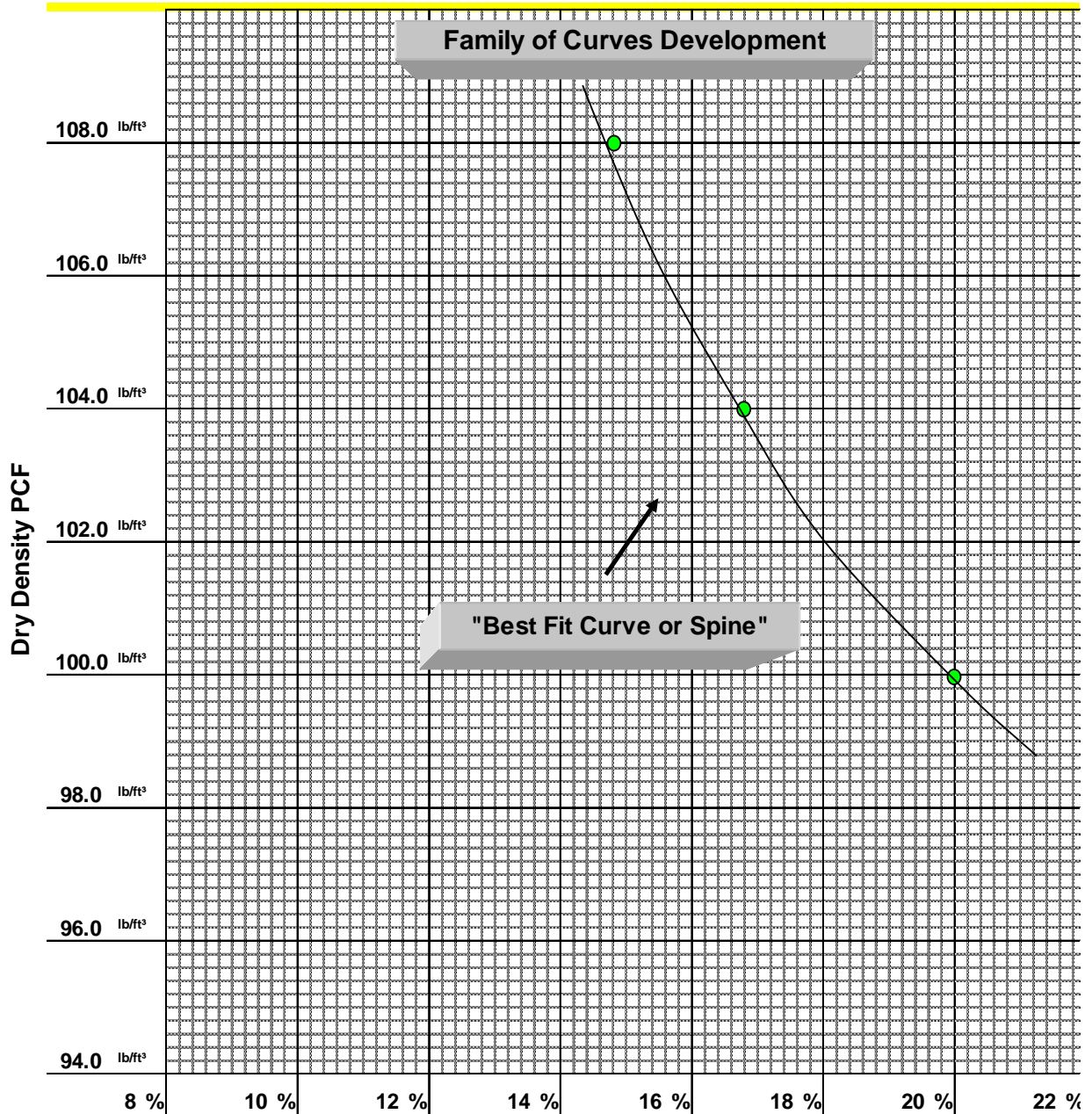

Step 6: Mark each maximum density-optimum moisture point with a dry side arc of sufficient length to meet the dry side leg. Plot a point on the "dry side" and connect the arc with the point using a tangent line.

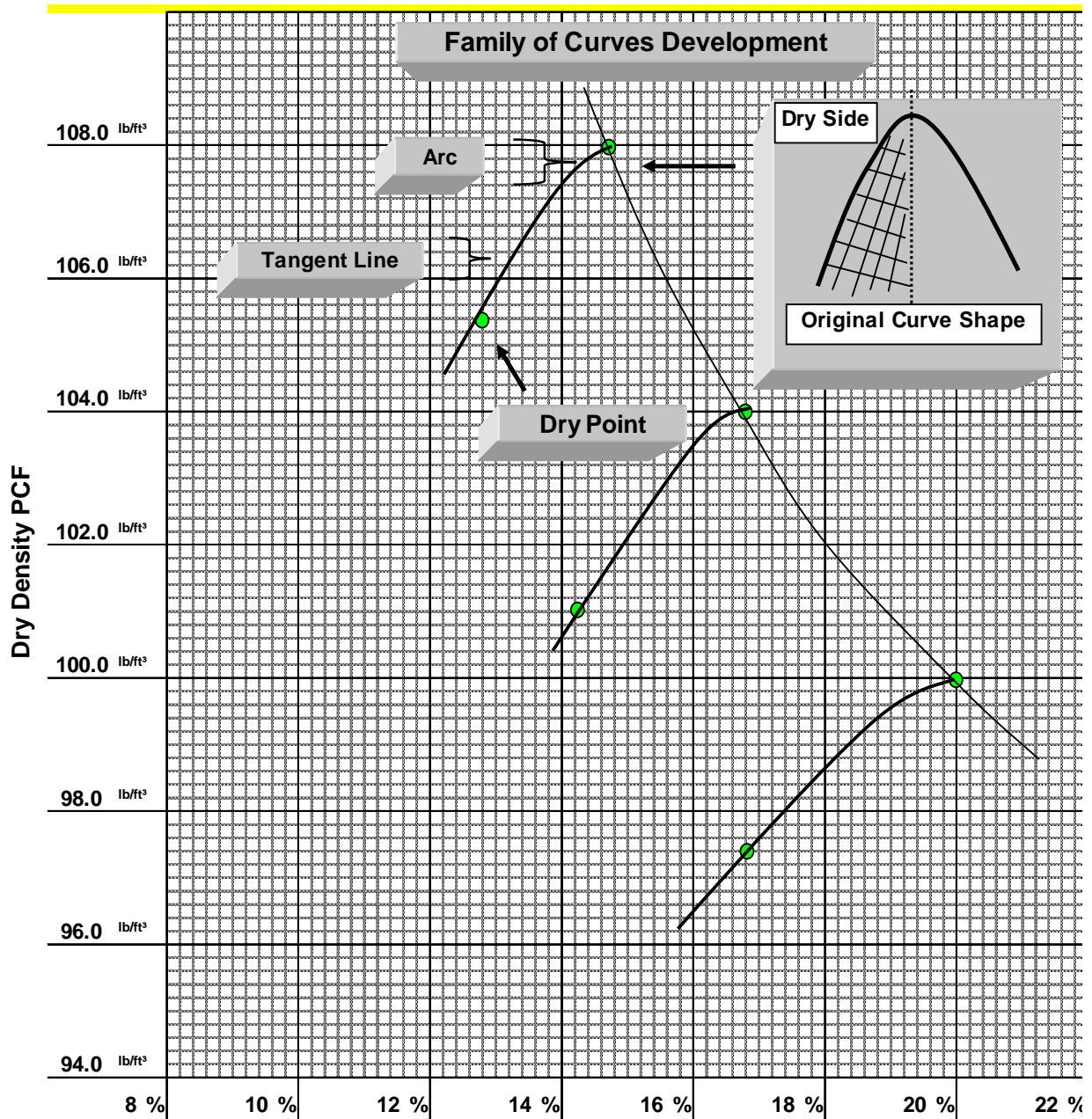

Step 7: Establish the 80% of Optimum Moisture Line at the bottom of the "dry side" legs.

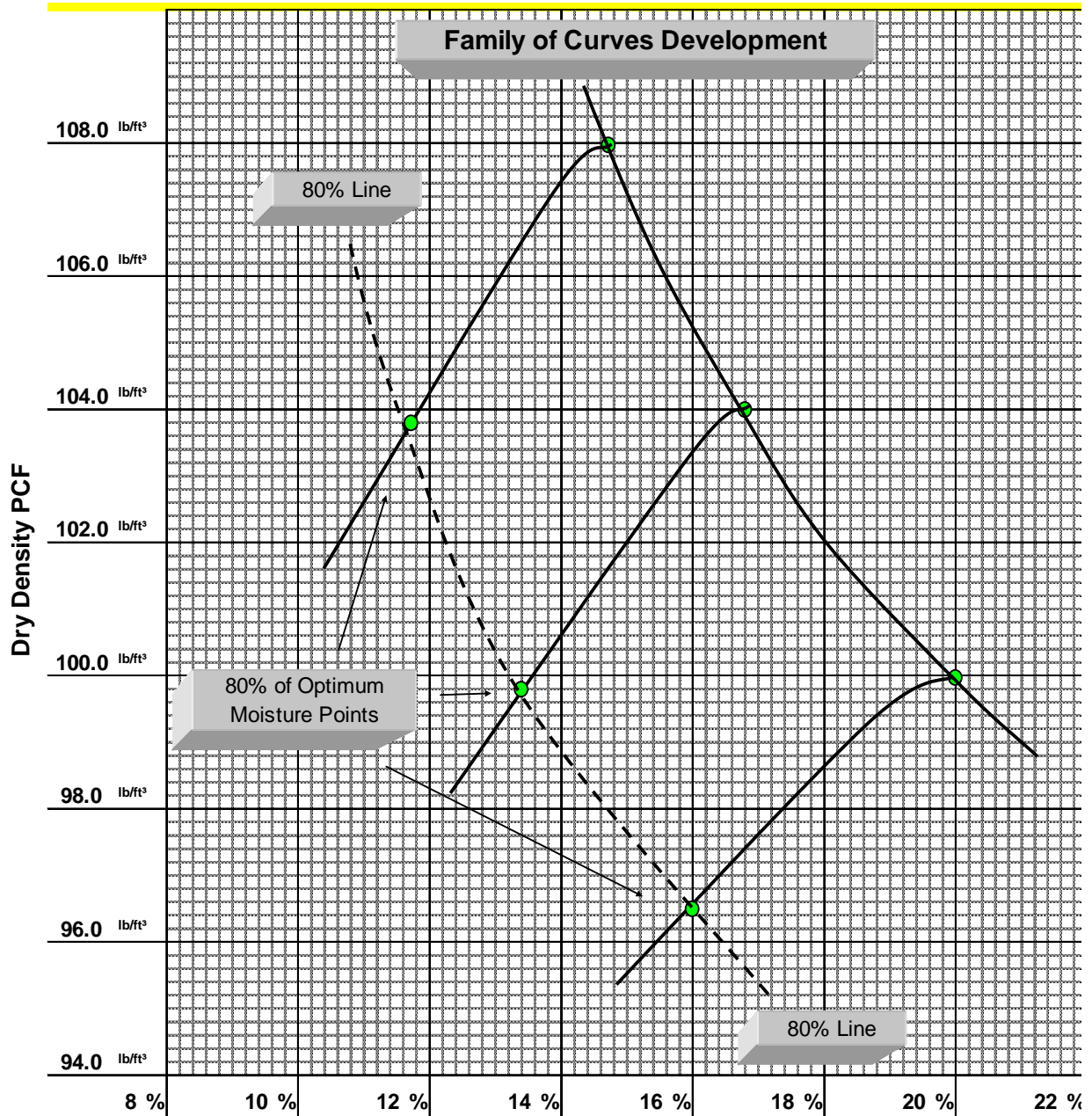

Step 8: At 2.0 lbs/ft³ increments draw moisture-density relationships using slopes similar to those of the original moisture-density relationships.

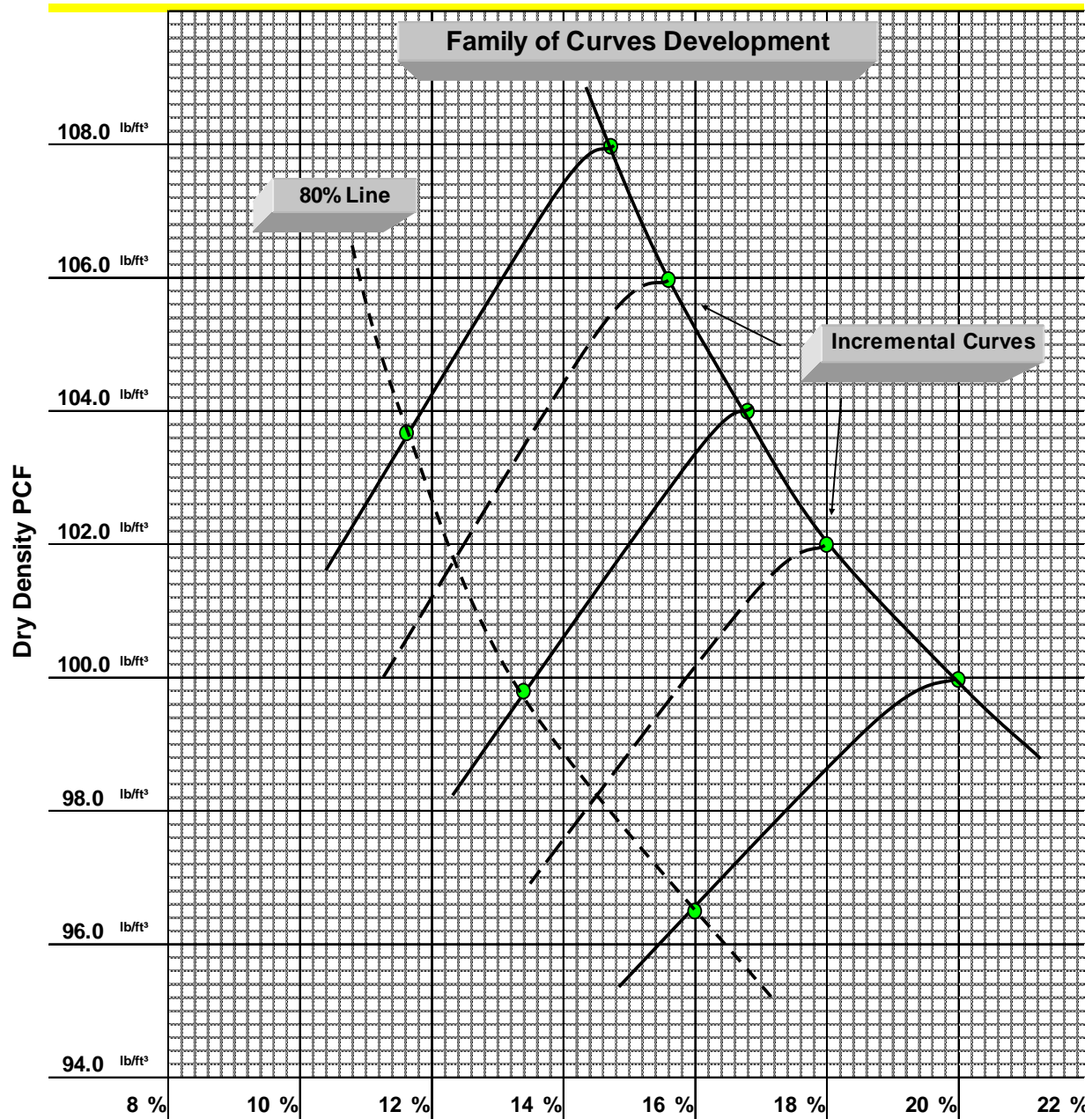

Report

- Include original curve data with family.
- Include Gsb & Absorption information of retained material, if available.



Oregon

Kate Brown, Governor

Department of Transportation

Construction Section
800 Airport Road SE
Salem, OR 97301-4792
Phone: (503) 986-3000
Fax: (503) 986-3096

November 30, 2016

To: All Holders of the Manual of Field Test Procedures

Section: **Test Procedure AASHTO R 76**

The Oregon Department of Transportation has specified method(s) for this Test Procedure. Please observe the following for our projects:

- **Delete the Method Selection section and replace with the following**

Samples of FA which are drier than the saturated surface dry (SSD) condition shall be reduced by a mechanical splitter according to Method A. As a quick determination, if the fine aggregate will retain its shape when molded with the hand, it is wetter than SSD.

Samples of FA that are at SSD or wetter than SSD shall be reduced by Method B, or the entire sample may be dried to the SSD condition – using temperatures that do not exceed those specified for any of the tests contemplated – and then reduced to test sample size using Method A.

Samples of CA or mixtures of FA and CA may be reduced by either method. Method A is not recommended for FA / CA mixtures that adhere to the apparatus.

REDUCING SAMPLES OF AGGREGATE TO TESTING SIZE FOP FOR AASHTO R 76

Scope

This procedure covers the reduction of samples to the appropriate size for testing in accordance with AASHTO R 76-16. Techniques are used that minimize variations in characteristics between test samples and field samples. Method A (Mechanical Splitter) and Method B (Quartering) are covered.

This FOP applies to fine aggregate (FA), coarse aggregate (CA), and mixes of the two (FA / CA) and may also be used on soils.

Apparatus

Method A – Mechanical Splitter

Splitter chutes:

- Even number of equal width chutes
- Discharge alternately to each side
- Minimum of 8 chutes total for CA and FA / CA, 12 chutes total for FA
- Width:
 - Minimum 50 percent larger than largest particle
 - Maximum chute width of 19 mm (3/4 in.) for fine aggregate passing the 9.5 mm (3/8 in.) sieve

Feed control:

- Hopper or straightedge pan with a width equal to or slightly less than the overall width of the assembly of chutes
- Capable of feeding the splitter at a controlled rate

Splitter receptacles / pans:

- Capable of holding two halves of the sample following splitting

The splitter and accessory equipment shall be so designed that the sample will flow smoothly without restriction or loss of material.

Method B – Quartering

- Straightedge scoop, shovel, or trowel
- Broom or brush
- Canvas or plastic sheet, appropriate for the amount and size of the material being reduced

Method Selection

Samples of CA may be reduced by either Method A or Method B.

Samples of FA which are drier than the saturated surface dry (SSD) condition, as described in AASHTO T 84, shall be reduced by a mechanical splitter according to Method A. As a quick approximation, if the fine aggregate will retain its shape when molded with the hand, it is wetter than SSD.

Samples of FA / CA which are drier than SSD may be reduced by Method A or Method B.

Samples of FA and FA / CA that are at SSD or wetter than SSD shall be reduced by Method B, or the entire sample may be dried – using temperatures that do not exceed those specified for any of the tests contemplated – and then reduced to test sample size using Method A.

Table 1

	Drier than SSD	Wetter than SSD
Fine Aggregate (FA)	Method A (Mechanical)	Method B (Quartering)
Mixture of FA/CA	Either Method	Method B (Quartering)
Coarse Aggregate (CA)	Either Method	Either Method

Procedure

Method A – Mechanical Splitter

1. Place two clean empty receptacles under the splitter.
2. Empty the sample into the hopper or pan without loss of material.
3. Uniformly distribute the material in the hopper or pan from edge to edge so that approximately equal amounts flow through each chute.
4. Discharge the material at a uniform rate, allowing it to flow freely through the chutes.
5. Remove any material retained on the surface of the splitter and place into the appropriate receptacle.
6. Using one of the two receptacles containing material, repeat Steps 1 through 6 until the material in one of the two receptacles is the appropriate sample size for the required test.
7. Retain and properly identify the remaining unused sample for further testing if required.

Mechanical Splitter Check

- Determine the mass of each reduced portion. If the percent difference of the two masses is greater than 5 percent, corrective action must be taken.

Calculation

$$\frac{\text{Smaller Mass}}{\text{Larger Mass}} = \text{Ratio} \quad (1 - \text{ratio}) \times 100 = \% \text{ Difference}$$

Splitter check: 5127 g total sample mass

Splitter pan #1: 2583 g

Splitter pan #2: 2544 g

$$\frac{2544 \text{ g}}{2583 \text{ g}} = 0.985 \quad (1 - 0.985) \times 100 = 1.5\%$$

Alternative to Mechanical Splitter Check

- In lieu of determining the mass of each reduced portion, use the method illustrated in Figure 1 or 2 during reduction.

Figure 1

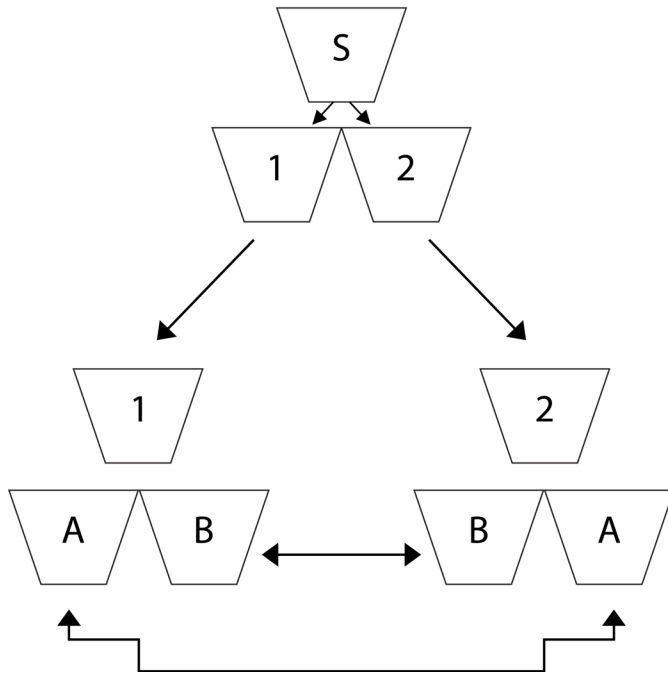

- Sample (S) is an amount greater than or equal to twice the mass needed for testing. Sample (S) is reduced in a mechanical splitter to yield parts (1) and (2).
- Part (1) is further reduced yielding (A) and (B) while part (2) is reduced to yield (B) and (A).
- Final testing sample is produced by combining alternate pans, i.e. A/A or B/B only.

Figure 2

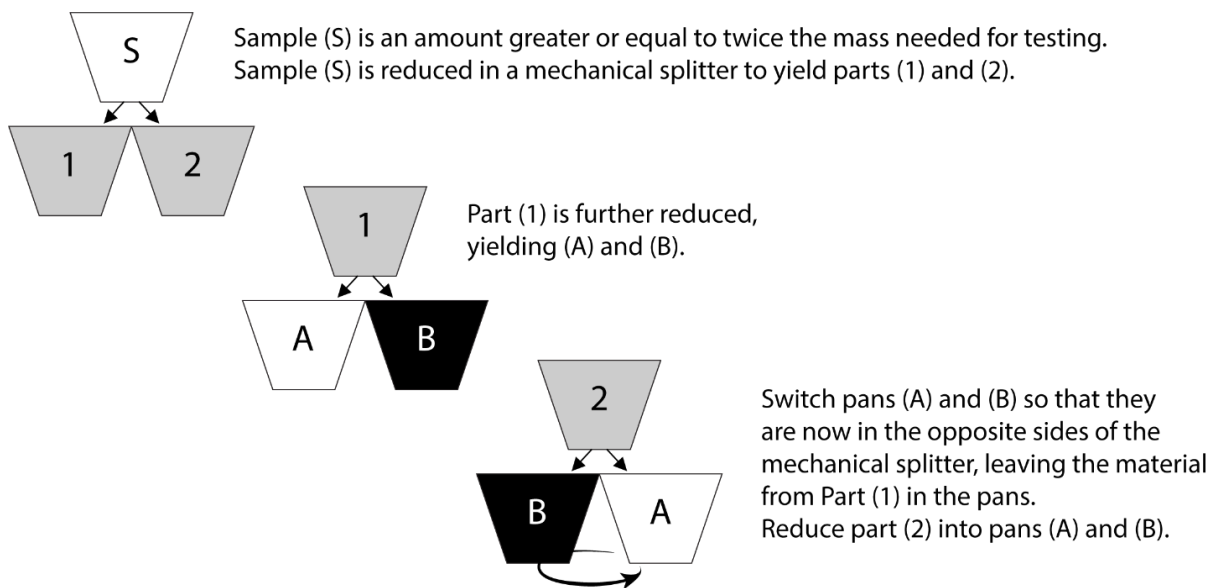

Method B – Quartering

Use either of the following two procedures or a combination of both.

Procedure 1: Quartering on a clean, hard, level surface:

1. Place the sample on a hard, clean, level surface where there will be neither loss of material nor the accidental addition of foreign material.
2. Mix the material thoroughly by turning the entire sample over a minimum of four times. With the last turning, shovel the entire sample into a conical pile by depositing each shovelful on top of the preceding one.
3. Flatten the conical pile to a uniform thickness and diameter by pressing down with a shovel. The diameter should be four to eight times the thickness.
4. Divide the flattened pile into four approximately equal quarters with a shovel or trowel.
5. Remove two diagonally opposite quarters, including all fine material, and brush the cleared spaces clean.
6. Successively mix and quarter the remaining material until the sample is reduced to the desired size.
7. The final test sample consists of two diagonally opposite quarters.

Procedure 2: Quartering on a canvas or plastic sheet:

1. Place the sample on the sheet.
2. Mix the material thoroughly a minimum of four times by pulling each corner of the sheet horizontally over the sample toward the opposite corner. After the last turn, form a conical pile.
3. Flatten the conical pile to a uniform thickness and diameter by pressing down with a shovel. The diameter should be four to eight times the thickness.
4. Divide the flattened pile into four approximately equal quarters with a shovel or trowel, or, insert a stick or pipe beneath the sheet and under the center of the pile, then lift both ends of the stick, dividing the sample into two roughly equal parts. Remove the stick leaving a fold of the sheet between the divided portions. Insert the stick under the center of the pile at right angles to the first division and again lift both ends of the stick, dividing the sample into four roughly equal quarters.
5. Remove two diagonally opposite quarters, being careful to clean the fines from the sheet.

6. Successively mix and quarter the remaining material until the sample size is reduced to the desired size.
7. The final test sample consists of two diagonally opposite quarters.



Oregon

Kate Brown, Governor

Department of Transportation

Construction Section
800 Airport Road SE
Salem, OR 97301-4792
Phone: (503) 986-3000
Fax: (503) 986-3096

November 30, 2020

To: All Holders of the Manual of Field Test Procedures

Section: **Test Procedure AASHTO R 90**

The Oregon Department of Transportation has specified method(s) for this Test Procedure. Please observe the following for our projects:

For all produced aggregates the definition of “Nominal Maximum Size” shall be as follows:

“One sieve larger than the first sieve that retains more than 10% of the material using an agency specified set of sieves based on cumulative percent retained. Where large gaps in specification sieves exist, intermediate sieve(s) may be inserted to determine nominal maximum size.”

SAMPLING AGGREGATE PRODUCTS FOP FOR AASHTO R 90

Scope

This procedure covers sampling of coarse, fine, or a combination of coarse and fine aggregates (CA and FA) in accordance with AASHTO R 90-18. Sampling from conveyor belts, transport units, roadways, and stockpiles is covered.

Apparatus

- Shovels or scoops, or both
- Brooms, brushes, and scraping tools
- Sampling tubes of acceptable dimensions
- Mechanical sampling systems: normally a permanently attached device that allows a sample container to pass perpendicularly through the entire stream of material or diverts the entire stream of material into the container by manual, hydraulic, or pneumatic operation
- Belt template
- Sampling containers

Procedure – General

Sampling is as important as testing. The technician shall use every precaution to obtain samples that are representative of the material. Determine the time or location for sampling in a random manner.

1. Wherever samples are taken, obtain multiple increments of approximately equal size.
2. Mix the increments thoroughly to form a field sample that meets or exceeds the minimum mass recommended in Table 1.

TABLE 1
Recommended Sample Sizes

Nominal Maximum		Minimum Mass	
Size*			
mm (in.)		g (lb)	
90	(3 1/2)	175,000	(385)
75	(3)	150,000	(330)
63	(2 1/2)	125,000	(275)
50	(2)	100,000	(220)
37.5	(1 1/2)	75,000	(165)
25.0	(1)	50,000	(110)
19.0	(3/4)	25,000	(55)
12.5	(1/2)	15,000	(35)
9.5	(3/8)	10,000	(25)
4.75	(No. 4)	10,000	(25)
2.36	(No. 8)	10,000	(25)

* One sieve larger than the first sieve to retain more than 10 percent of the material using an agency specified set of sieves based on cumulative percent retained. Where large gaps in specification sieves exist, intermediate sieve(s) may be inserted to determine nominal maximum size. Maximum size is one size larger than nominal maximum size.

Note 1: Sample size is based upon the test(s) required. As a general rule, the field sample size should be such that, when split twice will provide a testing sample of proper size. For example, the sample size may be four times that shown in Table 1 of the FOP for AASHTO T 27/T 11, if that mass is more appropriate.

Procedure – Specific Situations

Conveyor Belts

Avoid sampling at the beginning or end of the aggregate run due to the potential for segregation. Be careful when sampling in the rain. Make sure to capture fines that may stick to the belt or that the rain tends to wash away.

Method A (From the Belt)

1. Stop the belt.
2. Set the sampling template in place on the belt, avoiding intrusion by adjacent material.
3. Remove the material from inside the template, including all fines.
4. Obtain at least three approximately equal increments.
5. Combine the increments to form a single sample.

Method B (From the Belt Discharge)

1. Pass a sampling device through the full stream of the material as it runs off the end of the conveyor belt. The sampling device may be manually, semi-automatic or automatically powered.
2. The sampling device shall pass through the stream at least twice, once in each direction, without overfilling while maintaining a constant speed during the sampling process.
3. When emptying the sampling device into the container, include all fines.
4. Combine the increments to form a single sample.

Transport Units

1. Visually divide the unit into four quadrants.
2. Identify one sampling location in each quadrant.
3. Dig down and remove approximately 0.3 m (1 ft.) of material to avoid surface segregation. Obtain each increment from below this level.
4. Combine the increments to form a single sample.

Roadways**Method A (Berm or Windrow)**

- Obtain sample before spreading.
- Take the increments from at least three random locations along the fully formed windrow or berm. Do not take the increments from the beginning or the end of the windrow or berm.
- Obtain full cross-section samples of approximately equal size at each location. Take care to exclude the underlying material.
- Combine the increments to form a single sample.

Note 2: Obtaining samples from berms or windrows may yield extra-large samples and may not be the preferred sampling location.

Method B (In-Place)

- Obtain sample after spreading and before compaction.
- Take the increments from at least three random locations.
- Obtain full-depth increments of approximately equal size from each location. Take care to exclude the underlying material.
- Combine the increments to form a single sample.

Stockpiles

Method A – Loader Sampling

1. Direct the loader operator to enter the stockpile with the bucket at least 150 mm (6 in.) above ground level without contaminating the stockpile.
2. Discard the first bucketful.
3. Have the loader re-enter the stockpile and obtain a full loader bucket of the material, tilt the bucket back and up.
4. Form a small sampling pile at the base of the stockpile by gently rolling the material out of the bucket with the bucket just high enough to permit free-flow of the material. (Repeat as necessary.)
5. Create a flat surface by having the loader back drag the small pile.
6. Visually divide the flat surface into four quadrants.
7. Collect an increment from each quadrant by fully inserting the shovel into the flat pile as vertically as possible, take care to exclude the underlying material, roll back the shovel and lift the material slowly out of the pile to avoid material rolling off the shovel.

Method B – Stockpile Face Sampling

1. Create horizontal surfaces with vertical faces in the top, middle, and bottom third of the stockpile with a shovel or loader.
2. Prevent continued sloughing by shoving a flat board against the vertical face. Sloughed material will be discarded to create the horizontal surface.
3. Obtain sample from the horizontal surface as close to the intersection as possible of the horizontal and vertical faces.
4. Obtain at least one increment of equal size from each of the top, middle, and bottom thirds of the pile.
5. Combine the increments to form a single sample.

Method C – Alternate Tube Method (Fine Aggregate)

1. Remove the outer layer that may have become segregated.
2. Using a sampling tube, obtain one increment of equal size from a minimum of five random locations on the pile.
3. Combine the increments to form a single sample.

Identification and Shipping

- Identify samples according to agency standards.
- Include sample report (below).
- Ship samples in containers that will prevent loss, contamination, or damage of material.

Report

- On forms approved by the agency
- Date
- Time
- Sample ID
- Sampling method
- Location
- Quantity represented
- Material type
- Supplier



Oregon

Kate Brown, Governor

Department of Transportation

Construction Section
800 Airport Road SE
Salem, OR 97301-4792
Phone: (503) 986-3000
Fax: (503) 986-3096

November 30, 2019

To: All Holders of the Manual of Field Test Procedures

Section: **Test Procedure AASHTO R 97**

The Oregon Department of Transportation has specified method(s) for this Test Procedure.

Please observe the following for our projects:

The following sampling locations are not permitted:

- **Conveyor Belts**
- **Stockpiles, Method 1 and 2**

SAMPLING ASPHALT MIXTURES FOP FOR AASHTO R 97

Scope

This procedure covers the sampling of asphalt mixtures from plants, haul units, and roadways in accordance with AASHTO R 97-19. Sampling is as important as testing, use care to obtain a representative sample and to avoid segregation and contamination of the material during sampling.

This standard does not purport to address all of the safety concerns, if any, associated with its use. It is the responsibility of the user of this standard to establish appropriate safety and health practices and determine the applicability of regulatory limitations prior to use.

Apparatus

- Shovel or Metal Scoops, or Other Equipment: square-head metal shovels at least 125 mm (5.5 in.) wide.
- Sample containers: such as cardboard boxes, metal cans, stainless steel bowls, or other agency-approved containers
- Sampling plate: thick metal plate, minimum 8 gauge, sized to accommodate sample requirements, with a wire attached to one corner long enough to reach from the center of the paver to the outside of the farthest auger extension. A minimum of one hole 6 mm (0.25 in.) in diameter must be provided in a corner of the plate.
- Cookie cutter sampling device: formed steel angle with two 100 mm by 150 mm by 9 mm (4 in. by 6 in. by 3/8 in.) handles, sized to accommodate sample requirements. Minimum 50 mm (2 in.) smaller than the sampling plate when used together.

Example: Sampling plate 380 mm (15 in.) square and a cookie cutter sampling device 330 mm (13 in.) square.

- Mechanical sampling device: a permanently attached device that allows a sample receptacle to pass perpendicularly through the entire stream of material or diverts the entire stream of material into the container by manual, hydraulic, or pneumatic operation.
- Release agent: a non-stick product that prevents the asphalt mixture from sticking to the apparatus and does not contain solvents or petroleum-based products that could affect asphalt binder properties.

Sample Size

Sample size depends on the test methods specified by the agency for acceptance. Check agency requirement for the size required.

Procedure

General

- Select sample locations using a random or stratified random sampling procedure, as specified by the agency. The material shall be tested to determine variations. The supplier/contractor shall provide equipment for safe and appropriate sampling, including sampling devices on plants when required.
- Ensure the container(s) and sampling equipment are clean and dry before sampling.
- For dense graded mixture samples use cardboard boxes, stainless steel bowls or other agency-approved containers.
- For hot open graded mixture samples use stainless steel bowls. Do not put open graded mixture samples in boxes until they have cooled to the point that asphalt binder will not migrate from the aggregate.

Attached Sampling Devices

These are normally permanently attached devices that allow a sample container to pass perpendicularly through the entire stream of material. Operation may be hydraulic, pneumatic, or manual and allows the sample container to pass through the stream twice, once in each direction, without overfilling. A sampling device may also divert the entire stream into a sampling receptacle.

1. Lightly coat the container attached to the sampling device with an agency-approved release agent or preheat it, or both, to approximately the same discharge temperature of the mix.
2. Pass the container twice through the material perpendicularly without overfilling the container.
3. Transfer the asphalt mixture to an agency-approved container without loss of material.
4. Repeat until proper sample size has been obtained.
5. Combine the increments to form a single sample.

Conveyor Belts

1. Avoid sampling at the beginning or end of an asphalt mixture production run due to the potential for segregation.
2. Stop the belt containing asphalt mixture.
3. Set the sampling template into the asphalt mixture on the belt, avoiding intrusion by adjacent material.
4. Remove the asphalt mixture from inside the template, including all fines, and place in a sample container.
5. Repeat, obtaining equal size increments, until proper sample size has been obtained.
6. Combine the increments to form a single sample.

Haul Units

1. Visually divide the haul unit into approximately four equal quadrants.
2. Identify one sampling location in each quadrant.
3. Dig down and remove approximately 0.3 m (1 ft.) of material to avoid surface segregation. Obtain each increment from below this level.
4. Combine the increments to form a sample of the required size.

Paver Auger

1. Obtain samples from the end of the auger using a square head shovel.
2. Place the shovel in front of the auger extension, with the shovel blade flat upon the surface to be paved over.
3. Allow the front face of the auger stream to cover the shovel with asphalt mixture, remove the shovel before the auger reaches it by lifting as vertically as possible.
4. Place asphalt mixture in a sample container.
5. Repeat until proper sample size has been obtained.
6. Combine the increments to form a sample of the required size.

Note 1: First full shovel of material may be discarded to preheat and ‘butter’ the shovel.

Windrow

1. Obtain samples from the windrow of a transport unit. Avoid the beginning or the end of the windrow section.
2. Visually divide the windrow into approximately three equal sections.
3. Remove approximately 0.3 m (1 ft) from the top of each section.
4. Fully insert the shovel into the flat surface as vertically as possible, exclude the underlying material, roll back the shovel and lift the material slowly out of the windrow to avoid material rolling off the shovel.
5. Place in a sample container.
6. Repeat, obtaining equal size increments, in each of the remaining thirds.
7. Combine the increments to form a sample of the required size.

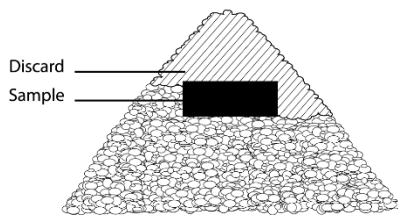

Windrow cross section

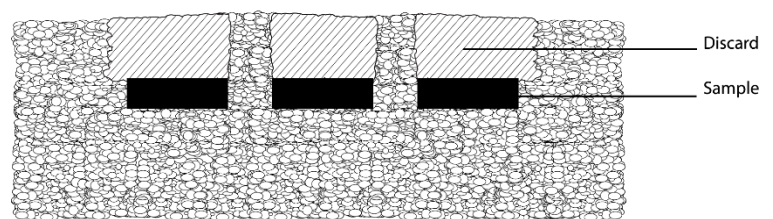

Windrow side view

Roadway before Compaction

There are two conditions that will be encountered when sampling asphalt mixtures from the roadway before compaction. The two conditions are:

- Laying asphalt mixture on grade or untreated base material requires Method 1.
- Laying asphalt mixture on existing asphalt or laying a second lift of asphalt mixture requires Method 2.

SAFETY:

Sampling is performed behind the paving machine and in front of the breakdown roller. For safety, the roller must remain at least 3 m (10 ft.) behind the sampling operation until the sample has been taken and the hole filled with loose asphalt mixture.

Method 1 requires a plate to be placed in the roadway in front of the paving operation and therefore there is always concern with moving, operating equipment. It is safest to stop the paving train while a plate is installed in front of the paver. When this is not possible the following safety rules must be followed.

1. The plate placing operation must be at least 3 m (10 ft.) in front of the paver or pickup device. The technician placing the plate must have eye contact and communication with the paving machine operator. If eye contact cannot be maintained at all time, a third person must be present to provide communication between the operator and the technician.
2. No technician is to be between the asphalt supply trucks and the paving machine. The exception to this rule is if the supply truck is moving forward creating a windrow, in which case the technician must be at least 3 m (10 ft.) behind the truck.

If at any time the Engineer feels that the sampling technique is creating an unsafe condition, the operation is to be halted until it is made safe or the paving operation will be stopped while the plate is being placed.

Method 1 - Obtaining a Sample on Grade or Untreated Base (Plate Method)

1. Following the safety rules detailed above, the technician is to:
 - a. Smooth out a location in front of the paver at least 0.5 m (2 ft.) inside the edge of the mat.
 - b. Lay the plate down diagonally with the direction of travel, keeping it flat and tight to the base with the lead corner facing the paving machine.

Note 2: The plate may be secured by driving a nail through the hole in the lead corner of the plate.

2. Pull the wire, attached to the outside corner of the plate, taut past the edge of the asphalt mixture mat and secure it. Let the paving operation pass over the plate and wire.
3. Using the exposed end of the wire, pull the wire up through the fresh asphalt mixture to locate the corner of the plate.

- a. Plate only:
 - i. Using a small square head shovel or scoop, or both, remove the full depth of the asphalt mixture from the plate. Take care to prevent sloughing of adjacent material.
 - ii. Place asphalt mixture, including any material adhering to the plate and scoop or shovel in a sample container.
- b. "Cookie Cutter":
 - i. Place the "cookie cutter" sample device, just inside the end of the wire; align the cutter over the plate. Press "cookie cutter" device down through the asphalt mixture to the plate.
 - ii. Using a small square tipped shovel or scoop, or both, carefully remove all the asphalt mixture from inside of the cutter and place in a sample container.
 - iii. Remove the sample cutter and the plate from the roadway. The hole made from the sampling must be filled by the contractor with loose asphalt mixture.

Method 2 - Obtaining a Sample on Asphalt Surface (Non-plate Method)

1. After the paving machine has passed the sampling point, immediately place the "cookie cutter" sampling device on the location to be sampled.
2. Push the cutter down through the asphalt mixture until it is flat against the underlying asphalt mat.
3. Using a small square tipped shovel or scoop, or both, carefully remove all the asphalt mixture from inside of the cutter and place in a sample container.
4. Remove the cutter from the roadway. The hole made from the sampling must be filled by the contractor with loose asphalt mixture.

Stockpiles

Remove at least 0.1 m (4 in.) from the surface before sampling; mixtures in a stockpile may develop an oxidized crust.

Method 1 – Loader

1. Direct the loader operator to enter the stockpile with the bucket at least 0.3 m (1 ft) above ground level without contaminating the stockpile.
2. Obtain a full loader bucket of the asphalt mixture; tilt the bucket back and up.
3. Form a small sampling pile at the base of the stockpile by gently rolling the asphalt mixture out of the bucket with the bucket just high enough to permit free-flow of the mixture. Repeat as necessary.
4. Create a flat surface by having the loader "back-drag" the small pile.

5. Obtain approximately equal increments from at least three randomly selected locations on the flat surface at least 0.3 m (1 ft) from the edge.
6. Fully insert the shovel, exclude the underlying material, roll back the shovel and lift the asphalt mixture slowly out of the pile to avoid mixture rolling off the shovel.
7. Combine the increments to form a sample.

Method 2 – Stockpile Face

1. Create horizontal surfaces with vertical faces in the top, middle, and bottom third of the stockpile with a shovel or a loader if one is available.
2. Shove a flat board against the vertical face behind the sampling location to prevent sloughing of asphalt mixture. Discard the sloughed mixture to create the horizontal surface.
3. Obtain the sample from the horizontal surface as close as possible to the intersection of the horizontal and vertical faces.
4. Obtain at least one sample increment of equal size from each of the top, middle, and bottom thirds of the pile.
5. Combine the increments to form a single sample.

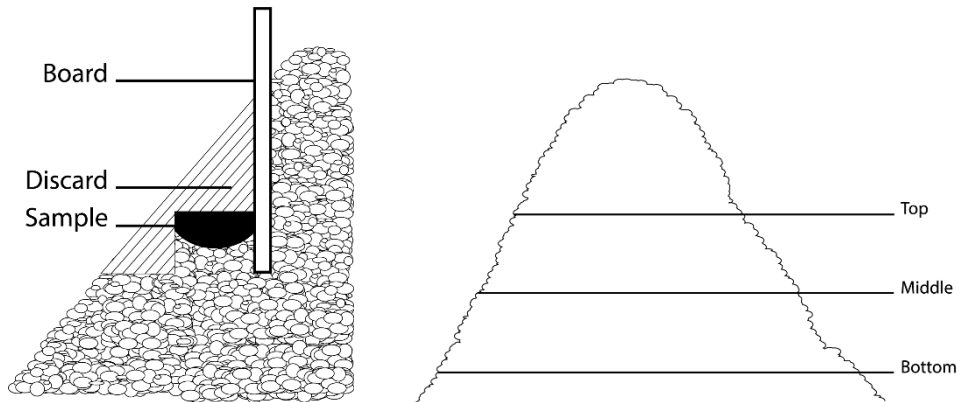

Identification and Shipping

1. Identify sample containers as required by the agency.
2. Ship samples in containers that will prevent loss, contamination, or damage.

Report

- On forms approved by the agency
- Sample ID
- Date
- Time
- Location
- Quantity represented

INSERT TAB

ASTM

INSERT TAB

WAQTC



Oregon

John A. Kitzhaber, M.D., Governor

Department of Transportation

Construction Section
800 Airport Road SE
Salem, OR 97301-4792
Phone: (503) 986-3000
Fax: (503) 986-3096

October 31, 2013

To: All Holders of the Manual of Field Test Procedures

Section: **Test Procedure WAQTC TM 2**

The Oregon Department of Transportation has specified method(s) for this Test Procedure. Please observe the following for our projects:

Under the Apparatus Section, delete bullet 6 and replace with the following:

- **Apparatus for wet sieving, including: a sieve(s), conforming to AASHTO M 92, of suitable size and conveniently arranged and supported so that the sieve can be shaken rapidly by hand.**

SAMPLING FRESHLY MIXED CONCRETE FOP FOR WAQTC TM 2

Scope

This method covers procedures for obtaining representative samples of fresh concrete delivered to the project site. The method includes sampling from stationary, paving and truck mixers, and from agitating and non-agitating equipment used to transport central mixed concrete.

This method also covers the removal of large aggregate particles by wet sieving.

Sampling concrete may involve hazardous materials, operations, and equipment. This standard does not purport to address all of the safety problems associated with its use. It is the responsibility of the user of this standard to establish appropriate safety and health practices.

Warning—Fresh Hydraulic cementitious mixtures are caustic and may cause chemical burns to skin and tissue upon prolonged exposure.

Apparatus

- Receptacle: wheelbarrow, bucket or other suitable container that does not alter the properties of the material being sampled
- Sample cover (plastic, canvas, or burlap)
- Shovel
- Cleaning equipment, including scrub brush, rubber gloves, water
- Apparatus for wet sieving, including: a sieve(s), meeting the requirements of FOP for AASHTO T 27/T 11, minimum of 2 ft² (0.19 m²) of sieving area, conveniently arranged and supported so that the sieve can be shaken rapidly by hand.

Procedure

1. Use every precaution in order to obtain samples representative of the true nature and condition of the concrete being placed being careful not to obtain samples from the very first or very last portions of the batch. The size of the sample will be 1.5 times the volume of concrete required for the specified testing, but not less than 0.03 m³ (1 ft³).
2. Dampen the surface of the receptacle just before sampling, empty any excess water.

Note 1: Sampling should normally be performed as the concrete is delivered from the mixer to the conveying vehicle used to transport the concrete to the forms; however, specifications may require other points of sampling, such as at the discharge of a concrete pump.

3. Use one of the following methods to obtain the sample:
 - **Sampling from stationary mixers**

Obtain the sample after a minimum of $1/2 \text{ m}^3$ ($1/2 \text{ yd}^3$) of concrete has been discharged. Perform sampling by passing a receptacle completely through the discharge stream, or by completely diverting the discharge into a receptacle. Take care not to restrict the flow of concrete from the mixer, container, or transportation unit so as to cause segregation. These requirements apply to both tilting and nontilting mixers.
 - **Sampling from paving mixers**

Obtain the sample after the contents of the paving mixer have been discharged. Obtain material from at least five different locations in the pile and combine into one test sample. Avoid contamination with subgrade material or prolonged contact with absorptive subgrade. To preclude contamination or absorption by the subgrade, the concrete may be sampled by placing a shallow container on the subgrade and discharging the concrete across the container.
 - **Sampling from revolving drum truck mixers or agitators**

Obtain the sample after a minimum of $1/2 \text{ m}^3$ ($1/2 \text{ yd}^3$) of concrete has been discharged. Obtain samples after all of the water has been added to the mixer. Do not obtain samples from the very first or last portions of the batch discharge. Perform sampling by repeatedly passing a receptacle through the entire discharge stream or by completely diverting the discharge into a receptacle. Regulate the rate of discharge of the batch by the rate of revolution of the drum and not by the size of the gate opening.
 - **Sampling from open-top truck mixers, agitators, non-agitating equipment or other types of open-top containers**

Obtain the sample by whichever of the procedures described above is most applicable under the given conditions.
 - **Sampling from pump or conveyor placement systems**

Obtain sample after a minimum of $1/2 \text{ m}^3$ ($1/2 \text{ yd}^3$) of concrete has been discharged. Obtain samples after all of the pump slurry has been eliminated. Perform sampling by repeatedly passing a receptacle through the entire discharge system or by completely diverting the discharge into a receptacle. Do not lower the pump arm from the placement position to ground level for ease of sampling, as it may modify the air content of the concrete being sampled. Do not obtain samples from the very first or last portions of the batch discharge.
4. Transport samples to the place where fresh concrete tests are to be performed and specimens are to be molded. They shall then be combined and remixed with a shovel the minimum amount necessary to ensure uniformity. Protect the sample from direct sunlight, wind, rain, and sources of contamination.

5. Complete test for temperature and start tests for slump and air content within 5 minutes of obtaining the sample. Start molding specimens for strength tests within 15 minutes of obtaining the sample. Complete the test methods as expeditiously as possible.

Wet Sieving

When required due to oversize aggregate, the concrete sample shall be wet sieved, after transporting but prior to remixing, for slump testing, air content testing or molding test specimens, by the following:

1. Place the sieve designated by the test procedure over the dampened receptacle.
2. Pass the concrete over the designated sieve. Do not overload the sieve (one particle thick).
3. Shake or vibrate the sieve until no more material passes the sieve. A horizontal back and forth motion is preferred.
4. Discard oversize material including all adherent mortar.
5. Repeat until sample of sufficient size is obtained. Mortar adhering to the wet-sieving equipment shall be included with the sample.
6. Using a shovel, remix the sample the minimum amount necessary to ensure uniformity.

Note 2: Wet sieving is not allowed for samples being used for density determinations according to the FOP for AASHTO T 121.

Report

- On standard agency forms
- Sample ID
- Date
- Time
- Location
- Quantity represented

VOLUMETRIC PROPERTIES OF ASPHALT MIXTURES WAQTC TM 13

Scope

This procedure covers the determination of volumetric properties of plant produced Hot Mix Asphalt, i.e., air voids (V_a), voids in mineral aggregate (VMA), voids filled with asphalt binder (VFA), effective asphalt binder content (P_{be}) and Dust to Binder Ratio ($P_{\#200}/P_{be}$). The in-production volumetric properties are then compared to agency specifications.

Definition of Terms

- G_{mm} = theoretical maximum specific gravity (Gravity_{mix max})
- G_{mb} = measured bulk specific gravity (Gravity_{mix bulk})
- G_{sb} = oven-dry bulk specific gravity of aggregate (Gravity_{stone bulk})
- G_{sa} = apparent specific gravity of aggregate (Gravity_{stone apparent})
- G_{se} = effective specific gravity of aggregate (Gravity_{stone effective})
- G_b = specific gravity of the binder (Gravity_{binder})
- V_a = air Voids (Voids_{air})
- VMA = Voids in Mineral Aggregate
- VFA = Voids Filled with Asphalt (binder)
- V_{ba} = absorbed binder volume (Voids_{binder absorbed})
- V_{be} = effective binder volume (Voids_{binder effective})
- P_b = percent binder content (Percent_{binder})
- P_{ba} = percent absorbed binder (Percent_{binder absorbed})
- P_{be} = percent effective binder content (Percent_{binder effective})
- P_s = percent of aggregate (Percent_{stone})
- DP = Dust proportion to effective binder ratio
($P_{\#200}/P_{be}$)

Background

Whether a mix design is developed through a Marshall, Hveem, or Superpave mix design process there are basic volumetric requirements of all. Volumetric properties are the properties of a defined material contained in a known volume. Asphalt mixture volumetric properties can include bulk specific gravity, theoretical maximum specific gravity, air voids, and voids in mineral aggregate.

Many agencies specify values of the volumetric properties to ensure optimum performance of the pavement. The asphalt mixture must be designed to meet these criteria. In production the asphalt mixture is evaluated to determine if the mix still meets the specifications and is consistent with the original mix design (JMF). The production asphalt mixture may vary from the mix design and may need to be modified to meet the specified volumetric criteria.

To compare the in-production volumetric properties to agency specifications and the JMF a sample of loose asphalt mixture mix is obtained in accordance with FOP for AASHTO R 97. The sample is then compacted in a gyratory compactor to simulate the in-place asphalt mixture pavement after it has been placed, compacted, and the volumetric properties of the compacted sample are determined.

Asphalt mixture phase diagram

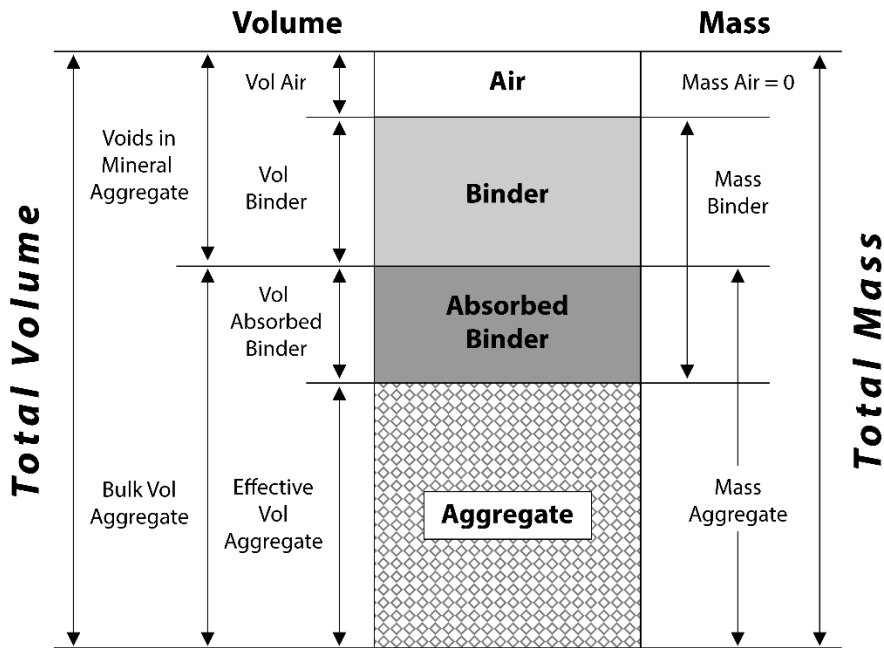

Each of the properties in the asphalt mixture phase diagram can be measured or calculated. For example: The mass of the aggregate is measured; the voids in mineral aggregate (VMA) is calculated; total asphalt binder can be measured but the amount available to act as a binder in the mix must be calculated because it is the quantity left after the aggregate has absorbed some of the asphalt binder.

The volumetric proportions of the asphalt binder and aggregate components of an asphalt mixture and their relationship to the other components are considered. The mass of the components and their specific gravities are used to determine the volumes of each of the components in the mix. The volumetric properties of a compacted asphalt mixture: air voids (V_a), voids in mineral aggregate (VMA), voids filled with asphalt binder (VFA), and effective asphalt binder content (P_{be}) provide some indication of the mixture's probable performance.

Volumetric Properties

Volumetric Relationship of Asphalt Mixture Constituents

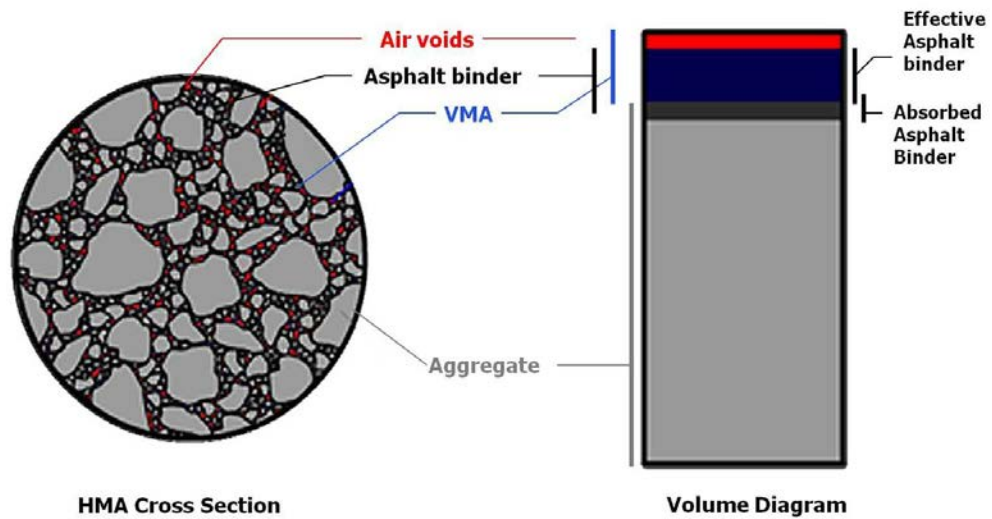

Required Values

The specific gravities listed in Table 1 and the percent by mass of each of the components in the asphalt mixture are needed to determine the volumetric properties. Other values required are also listed. Some of these values are obtained from the JMF and some are measured from a plant produced asphalt mixture sample.

Table 1

Data	Test Method	Obtained
G _{sb} - combined aggregate bulk specific gravity	AASHTO T 84 / T 85 or agency approved test method	JMF or performed at the beginning of placement
G _b - measured specific gravity of the asphalt binder	AASHTO T 228	JMF or from the supplier
G _{mm} - measured maximum specific gravity of the loose mix	FOP for AASHTO T 209	Performed on the field test sample
G _{mb} - measured bulk specific gravity of the compacted paving mix	FOP for AASHTO T 166	Performed on the field compacted specimen
P _b - percent asphalt binder	FOP for AASHTO T 308	Performed on the field test sample
P _{#200} - aggregate passing the #200 (75 μm) sieve	FOP for AASHTO T 30	Performed on the field test sample

Air Voids (V_a)

Air voids are the total volume of the small pockets of air between the coated aggregate particles throughout a compacted paving mixture. Appropriate air voids contribute to the stability of the asphalt mixture and help the pavement withstand the combined action of environment and traffic loads. The designated percent air voids allows for thermal expansion of the asphalt binder and contributes a cushion for future compaction. Air voids are expressed as a percent of the bulk volume of the compacted mixture (G_{mb}) when compared to the maximum specific gravity (G_{mm}).

$$V_a = 100 \left[\frac{(G_{mm} - G_{mb})}{G_{mm}} \right]$$

Where:

- V_a = air voids in compacted mixture, percent of total volume (report to 0.1)
- G_{mm} = maximum specific gravity of paving mixture (AASHTO T 209)
- G_{mb} = bulk specific gravity of compacted mixture (AASHTO T 166)

Percent Aggregate (Stone) (P_s)

P_s is the percent aggregate (stone) content, expressed as a percentage of the total mass of the sample.

$$P_s = 100 - P_b$$

Where:

- P_s = percent aggregate (stone) percent by total weight
- P_b = asphalt binder content (AASHTO T 308)

Voids in the Mineral Aggregate (VMA)

VMA is the volume of intergranular void space between the aggregate particles of the compacted paving mixture that includes the air voids and the effective binder content, expressed as a percent of the total volume of the sample.

$$VMA = 100 - \left[\frac{(G_{mb} \times P_s)}{G_{sb}} \right]$$

Where:

- VMA = voids in mineral aggregate, percent of bulk volume (report to 0.1)
- G_{sb} = bulk specific gravity of combined aggregate (AASHTO T 85 / T 84 or agency approved method from Job Mix Formula)
- G_{mb} = bulk specific gravity of compacted mixture (AASHTO T 166)
- P_s = aggregate content, percent by total weight = $100 - P_b$
- P_b = asphalt binder content (AASHTO T 308) percent by total weight

Voids Filled with Asphalt (binder) (VFA)

VFA is the volume of space between the aggregate particles of the compacted paving mixture filled with asphalt binder, expressed as a percent of the total volume of the sample. The VFA increases as the asphalt binder content increases as it is the percent of voids that are filled with asphalt which doesn't include the absorbed asphalt.

$$VFA = 100 \left[\frac{(VMA - V_a)}{VMA} \right]$$

Where:

- VFA = voids filled with asphalt, percent of VMA (report to 1)
- VMA = voids in mineral aggregate, percent of bulk volume
- V_a = air voids in compacted mixture, percent of total volume.

Effective Specific Gravity of the Aggregate (Stone) (G_{se})

The G_{se} is used to quantify the asphalt binder absorbed into the aggregate particle. This is a calculated value based on the specific gravity of the mixture, G_{mm} , and the specific gravity of the asphalt binder, G_b . This measurement includes the volume of the aggregate particle plus the void volume that becomes filled with water during the test soak period minus the volume of the voids that absorb asphalt binder. Effective specific gravity lies between apparent and bulk specific gravity.

G_{se} is formally defined as the ratio of the mass in air of a unit volume of a permeable material (excluding voids permeable to asphalt binder) at a stated temperature to the mass in air (of equal density) of an equal volume of gas-free distilled water at a stated temperature.

$$G_{se} = \frac{P_s}{\left[\left(\frac{100}{G_{mm}} \right) - \left(\frac{P_b}{G_b} \right) \right]}$$

Where:

G_{se} = effective specific gravity of combined aggregate (report to 0.001)

P_s = aggregate content, percent by total weight = 100 – P_b

G_{mm} = maximum specific gravity of mix (AASHTO T 209)

P_b = asphalt binder content (AASHTO T 308) percent by total weight

G_b = specific gravity of asphalt binder (JMF or asphalt binder supplier)

Percent of Absorbed (asphalt) Binder (P_{ba})

P_{ba} is the total percent of the asphalt binder that is absorbed into the aggregate, expressed as a percentage of the mass of aggregate rather than as a percentage of the total mass of the mixture. This portion of the asphalt binder content does not contribute to the performance of the mix.

$$P_{ba} = 100 \left[\frac{(G_{se} - G_{sb})}{(G_{sb} \times G_{se})} \right] G_b$$

Where:

P_{ba} = absorbed asphalt binder (report to 0.01) percent of aggregate

G_{se} = effective specific gravity of combined aggregate

G_{sb} = bulk specific gravity of combined aggregate (AASHTO T 85 / T 84 or agency approved method from Job Mix Formula)

G_b = specific gravity of asphalt binder (JMF or asphalt binder supplier)

Percent of Effective (asphalt) Binder (P_{be})

P_{be} is the total asphalt binder content of a paving mixture minus the portion of asphalt binder that is lost by absorption into the aggregate particles, expressed as a percentage of the mass of aggregate. It is the portion of the asphalt binder content that remains as a coating on the outside of the aggregate particles. This is the asphalt content that controls the performance of the mix.

$$P_{be} = P_b - \left[\frac{P_{ba}}{100} \times P_s \right]$$

Where:

P_{be} = effective asphalt binder content (report to 0.01), percent by total weight

P_s = aggregate content, percent by total weight = 100 – P_b

P_b = asphalt binder content (AASHTO T 308) percent by total weight

P_{ba} = absorbed asphalt binder

Dust Proportion – DP (Dust to Effective (asphalt) Binder Ratio)

The DP is the percent passing the No. 200 sieve of the gradation divided by the percent of effective asphalt binder. Excessive dust reduces asphalt binder film thickness on the aggregate which reduces the durability. Insufficient dust may allow excessive asphalt binder film thickness, which may result in a tender, unstable mix.

$$DP = \frac{P_{-#200}}{P_{be}}$$

Where:

DP = Dust Proportion, (dust-to-binder ratio) (report to 0.01)

$P_{-#200}$ = aggregate passing the -#200 (75 μ m) sieve, percent by mass of aggregate (AASHTO T 30)

P_{be} = effective asphalt binder content, percent by total weight

Mix Design and Production Values

Job Mix Formula

Table 2 includes example data required from the JMF. Some of these values are used in the example calculations.

Note: Some of the targets may change after the asphalt mixture is in production based on field test data.

Table 2

JMF Data	
Asphalt binder grade	PG 64-28
N _{values}	N _{ini} = 7 N_{des} = 75 N _{max} = 115
G _{sb} (combined specific gravity of the aggregate)	2.678
Target P _b	4.75%
Initial sample mass for gyratory specimens	4840 grams
Mixing temperature range	306 – 312 °F
Laboratory compaction temperature range	286 – 294 °F
G _b (specific gravity of the asphalt binder)	1.020
Target gradation	
Sieve Size mm (in.)	Percent Passing
19.0 (3/4)	100
12.5 (1/2)	85
9.5 (3/8)	80
4.75 (No. 4)	50
2.36 (No. 8)	30
01.18 (No. 16)	25
0.600 (No. 30)	15
0.300 (No. 50)	10
0.150 (No. 100)	7
75 μm (No. 200)	5.0

Sample Test Result

Tables 3 and 4 include data from test results performed on a field sample of asphalt mixture used in the example calculations.

Table 3

Field Data		
	Test method	Example values
P _b	FOP for AASHTO T 308	4.60%
G _{mb}	FOP for AASHTO T 166	2.415
G _{mm}	FOP for AASHTO T 209	2.516

Table 4

Sieve Analysis	
FOP for AASHTO T 30	
Sieve Size mm (in.)	Percent Passing
19.0 (3/4)	100
12.5 (1/2)	86
9.5 (3/8)	77
4.75 (No. 4)	51
2.36 (No. 8)	34
01.18 (No. 16)	23
0.600 (No. 30)	16
0.300 (No. 50)	12
0.150 (No. 100)	8
75 μm (No. 200)	4.9

Sample Calculations

Air Voids (V_a)

$$V_a = 100 \left[\frac{(G_{mm} - G_{mb})}{G_{mm}} \right]$$

$$V_a = 100 \left[\frac{(2.516 - 2.415)}{2.516} \right] = 4.01431\% \text{ report } 4.0\%$$

Given:

$$G_{mm} = 2.516$$

$$G_{mb} = 2.415$$

Percent Aggregate (Stone) (P_s)

$$P_s = 100 - P_b$$

$$P_s = 100.0 - 4.60\% = 95.40\%$$

Given:

$$P_b = 4.60\%$$

Voids in the Mineral Aggregate (VMA)

$$VMA = 100 - \left[\frac{(G_{mb} \times P_s)}{G_{sb}} \right]$$

$$VMA = 100.0 - \left[\frac{(2.415 \times 95.40\%)}{2.678} \right] = 13.96\% \text{ report } 14.0\%$$

Given:

$$G_{sb} = 2.678$$

Voids Filled with Asphalt (binder) (VFA)

$$VFA = 100 \left[\frac{(VMA - V_a)}{VMA} \right]$$

$$VFA = 100 \left[\frac{(14.0\% - 4.0\%)}{14.0\%} \right] = 71.4\% \text{ report } 71\%$$

Effective Specific Gravity of the Aggregate (Stone) (G_{se})

$$G_{se} = \frac{P_s}{\left[\left(\frac{100}{G_{mm}}\right) - \left(\frac{P_b}{G_b}\right)\right]}$$

$$G_{se} = \frac{(100 - 4.60\%)}{\left[\left(\frac{100}{2.516}\right) - \left(\frac{4.60\%}{1.020}\right)\right]} =$$

$$G_{se} = \frac{95.40\%}{39.74563 - 4.50980} = 2.70747 \text{ report } 2.707$$

Given:

$$G_b = 1.020$$

Percent of Absorbed (asphalt) Binder (P_{ba})

$$P_{ba} = 100 \left[\frac{(G_{se} - G_{sb})}{(G_{sb} \times G_{se})} \right] G_b$$

$$P_{ba} = 100 \left[\frac{(2.707 - 2.678)}{(2.678 \times 2.707)} \right] 1.020 =$$

$$P_{ba} = 100 \left[\frac{0.0290}{7.24935} \right] 1.020 = 0.40804\% \text{ report } 0.41\%$$

Percent of Effective (asphalt) Binder (P_{be})

$$P_{be} = P_b - \left[\frac{P_{ba}}{100} \times P_s \right]$$

$$P_{be} = 4.60 - \left[\frac{0.41\%}{100} \times (100 - 4.60\%) \right] = 4.20886\% \text{ report } 4.21\%$$

Dust Proportion – DP (Dust to Effective (asphalt) Binder Ratio)

$$DP = \frac{P_{\#200}}{P_{be}}$$

$$DP = \frac{4.9\%}{4.21\%} = 1.16390 \text{ report } 1.16$$

Given:

$$P_{\#200} = 4.9\%$$

Report

- Results on forms approved by the agency
- Sample ID
- Air Voids, V_a to the nearest 0.1 percent
- Voids in the Mineral Aggregate, VMA to the nearest 0.1 percent
- Voids Filled with Asphalt, VFA to the nearest whole value
- Effective Specific Gravity of Aggregate (stone), G_{se} to the nearest 0.001
- Percent of Absorbed (asphalt) Binder, P_{ba} to the nearest 0.01
- Percent Effective (asphalt) Binder, P_{be} to the nearest 0.01
- Dust Proportion, DP to the nearest 0.01

Appendix - Formulas

Air Voids (V_a)

$$V_a = 100 \left[\frac{(G_{mm} - G_{mb})}{G_{mm}} \right]$$

Where:

V_a = air voids in compacted mixture, percent of total volume (report to 0.1)

G_{mm} = maximum specific gravity of paving mixture (AASHTO T 209)

G_{mb} = bulk specific gravity of compacted mixture (AASHTO T 166)

Percent Aggregate (Stone) (P_s)

$$P_s = 100 - P_b$$

Where:

P_s = percent aggregate (stone) percent by total weight

P_b = asphalt binder content (AASHTO T 308)

Voids in the Mineral Aggregate (VMA)

$$VMA = 100 - \left[\frac{(G_{mb} \times P_s)}{G_{sb}} \right]$$

Where:

VMA = voids in mineral aggregate, percent of bulk volume (report to 0.1)

G_{sb} = bulk specific gravity of combined aggregate (AASHTO T 85 / T 84 or agency approved method from Job Mix Formula)

G_{mb} = bulk specific gravity of compacted mixture (AASHTO T 166)

P_s = aggregate content, percent by total weight = 100 - P_b

P_b = asphalt binder content (AASHTO T 308) percent by total weight

Voids Filled with Asphalt (binder) (VFA)

$$VFA = 100 \left[\frac{(VMA - V_a)}{VMA} \right]$$

Where:

VFA = voids filled with asphalt, percent of VMA (report to 1)

VMA = voids in mineral aggregate, percent of bulk volume

V_a = air voids in compacted mixture, percent of total volume.

Effective Specific Gravity of the Aggregate (Stone) (G_{se})

$$G_{se} = \frac{P_s}{\left[\left(\frac{100}{G_{mm}}\right) - \left(\frac{P_b}{G_b}\right)\right]}$$

Where:

- G_{se} = effective specific gravity of combined aggregate (report to 0.001)
- P_s = aggregate content, percent by total weight = 100 – P_b
- G_{mm} = maximum specific gravity of mix (AASHTO T 209)
- P_b = asphalt binder content (AASHTO T 308) percent by total weight
- G_b = specific gravity of asphalt binder (JMF or asphalt binder supplier)

Percent of Absorbed (asphalt) Binder (P_{ba})

$$P_{ba} = 100 \left[\frac{(G_{se} - G_{sb})}{(G_{sb} \times G_{se})} \right] G_b$$

Where:

- P_{ba} = absorbed asphalt binder (report to 0.01) percent of aggregate
- G_{se} = effective specific gravity of combined aggregate
- G_{sb} = bulk specific gravity of combined aggregate (AASHTO T 85 from Job Mix Formula)
- G_b = specific gravity of asphalt binder (JMF or asphalt binder supplier)

Percent of Effective (asphalt) Binder (P_{be})

$$P_{be} = P_b - \left[\frac{P_{ba}}{100} \times P_s \right]$$

Where:

- P_{be} = effective asphalt binder content (report to 0.01), percent by total weight
- P_s = aggregate content, percent by total weight = 100 – P_b
- P_b = asphalt binder content (AASHTO T 308) percent by total weight
- P_{ba} = absorbed asphalt binder

Dust Proportion – DP (Dust to Effective (asphalt) Binder Ratio)

$$DP = \frac{P_{\#200}}{P_{be}}$$

Where:

- DP = Dust Proportion, (dust-to-binder ratio) (report to 0.01)
- $P_{\#200}$ = aggregate passing the -#200 (75 μ m) sieve, percent by mass of aggregate (AASHTO T 30)
- P_{be} = effective asphalt binder content, percent by total weight

INSERT TAB

SECTION 2
Quality Assurance
Program



QUALITY ASSURANCE PROGRAM

(Revised December, 2019)

TABLE OF CONTENTS

I. Overview.....1

II. Roles and Responsibilities5

III. Laboratory Certification Program7

IV. Technician Certification Program14

V. Proficiency Sample Program.....25

VI. Product Specific QC/QA Testing Plan.....27

APPENDIXES

A. ODOT Approved Commercial Aggregate Product Program.....47

B. Contractor Quality Control Plan.....49

C. Troubleshooting Guide50

**OREGON DEPARTMENT OF TRANSPORTATION
QUALITY ASSURANCE PROGRAM**

I. OVERVIEW

The Oregon Department of Transportation (ODOT) has implemented a Quality Assurance (QA) program approach that complies with the FHWA Guidelines for a QA program for construction projects on the National Highway System. This program defines the responsibilities of the contractor and ODOT in order to satisfy the needs of the program. This program is currently used for all construction projects administered by ODOT or its consultants.

ODOT recognizes that there are other benefits of developing and implementing Quality Assurance specifications into its construction program. These benefits include:

- To improve the overall quality of highway and bridge construction; and
- To place responsibility on the contractor for quality control in contracted work.

The success of the Departments Quality Assurance program is dependent on three primary features. The first is the Laboratory Certification program, which is discussed in Section III, Pg. 7, of this document. The second is the Technician Certification program, which is discussed in Section IV, Pg. 14, and the final feature is the specific product QC/QA testing plan detailed in Section VI, Pg. 27, of this document.

Quality Assurance (QA)

Quality Assurance is defined as: *All those planned and systematic actions necessary to provide confidence that a product or service will satisfy given requirements for quality.*

ODOT has developed its QA Program, which includes three separate and distinct sub-programs as illustrated below:

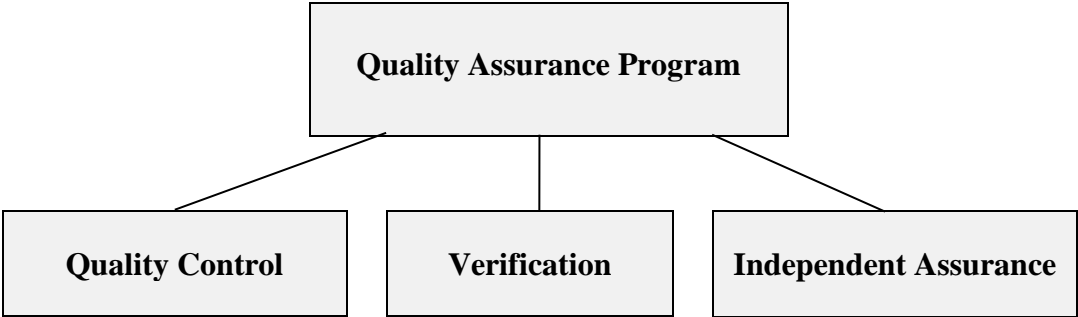

Quality Control (QC)

Quality Control is defined as: *All contractor/vendor operational techniques and activities that are performed or conducted to fulfill the contract requirements.*

The contractor is responsible for providing quality control sampling and testing, furnishing material of the quality specified, and furnishing QL levels during aggregate production, when required. The contractor's Quality Control technician must perform or observe the sampling operations. Testing operations will be performed by a Certified Technician. The certified technician, who performs the sampling and testing procedures, must sign the testing documentation.

Contractor quality control tests will be used for acceptance only if verified by tests performed by an independent group (Region QA).

Small quantities of some materials may be accepted when requested by the contractor and approved by the Project Manager (see Section 4(B) of MFTP).

ODOT will perform testing for all source/compliance tests and those non-field tested items associated with construction products (e.g. asphalt's, emulsions, tack, water, cement, lime, etc.).

Verification

Verification is defined as: *Sampling and testing performed to validate the quality of the product.*

Verification samples are taken randomly (minimum ten-percent frequency of subplot quantity identified in Section 4(D) of the MFTP) and tested by an independent group (Region QA) to verify that products meet required specification(s). Quality Control samples shall not be used for verification.

Independent Assurance

Independent Assurance is defined as: *Activities that are an unbiased and independent evaluation of all the sampling and testing procedures used in the acceptance program.*

ODOT's Independent Assurance (IA) Program uses a combination approach requiring laboratory certification, technician certification, proficiency samples, and where possible, split samples of verification or QC tests. The Construction Section certifies quality control and quality assurance testing laboratories and technicians. Contractor's test results of split IA samples are compared to Region QA test results for compliance using ODOT IA parameters. The PM performs random inspections of QC labs and technicians for compliance. The quality of Region QA test results are constantly monitored through the Departments proficiency samples program, which is outlined in, Section V, Pg. 25.

The Quality Assurance Testing (both Verification and Independent Assurance) will be performed by a Quality Assurance Laboratory designated by the Agency in compliance with 23 CFR 637.

Quality Assurance Program Components

Third-Party Resolution

Third Party Resolution is used when the Agency's Quality Assurance test results conflict with ongoing Quality Control test results and when verification requirements are not met or the conflict cannot be resolved. Third-Party Resolution can be requested by either the Contractor or the Project Manager.

Third Party Resolution testing shall be performed by a Dispute Resolution Laboratory. The Construction Section's Central Materials Laboratory performs third party dispute resolutions. This is normally done by testing quality control production backup samples, but may include other resolution techniques or procedures as determined by the agencies technical expert for the corresponding specification section.

The test result(s) of the Dispute Resolution Laboratory performing dispute resolution materials testing for any or all disputed test results will be considered the actual test results and will therefore be used for acceptance of the material.

CERTIFICATION ADVISORY COMMITTEE

The certification programs (both Technician and Laboratory Certifications) for ODOT's Quality Assurance program will be overseen by a Certification Advisory Committee. The purpose of this committee is to review and provide general oversight to the certification programs. The committee will be responsible for establishing policy as related to the certification programs and will also be responsible for reviewing allegations concerning abuse by technicians. The Certification Advisory Committee will perform other duties as required to successfully implement and continue the Certification Programs. A meeting of the committee may be called at any time by the Chair of the Certification Advisory Committee or by written request of at least two members of the Committee. A majority of the members of the Committee shall be present for transaction of official business.

Membership

Membership of the Certification Advisory Committee will include the following:

- ODOT Construction and Materials Engineer (Chair)
- ODOT Pavements Services Engineer
- ODOT Quality Assurance Engineer
- ODOT Structural Services Engineer
- ODOT Laboratory Services Manager
- APAO Executive Director or Representative
- OCAPA Executive Director or Representative

AGC Heavy Highway Representative
Industry “At Large” Representative (appointed by Committee)

Random Samples

The Quality Assurance Program is based on theoretical conditions and the application of statistical acceptance procedures. Sampling shall be by simple random, stratified random or systematic means as specified.

To obtain a representative sample, a reliable system of random sampling shall be employed. Some work, like process control, lends itself quite well to the use of the Random Units Table and the Random Sample Location forms that ODOT has developed. ODOT TM 400 Determining Random Sampling and Testing Locations is available to assist with random number determinations and test site locations. Random Sampling is the preferred method to assure that the samples are representative and to eliminate sampling bias. In other work, like Verification or Independent Assurance, it may be difficult to apply random numbers to sample selection. In this case, it is imperative that the samples are taken at locations or times, which do not have an identifiable pattern, and are completely random and without bias.

ODOT Approved Commercial Aggregate Product Program

The ODOT quality assurance program allows some freedom for commercial sources to establish their own quality control plan that is tailored to the operation of the specific commercial source. The commercial supplier is required to submit a written quality control plan to the appropriate Region Quality Assurance Coordinator for approval. All testing for the approved quality control plan is required to be performed by a certified technician in an ODOT certified laboratory. Specific details on ODOT Approved Commercial Aggregate Product Program may be found in Appendix A, Pg. 47.

II. ROLES AND RESPONSIBILITIES

Contractor

The contractor's responsibilities are to:

- Furnish a written quality control plan (See Appendix B, Pg. 49, for minimum requirements);
- Furnish and incorporate materials/products which are of the quality specified;
- Provide ODOT certified technicians and laboratories;
- Perform quality control of all materials/products used on ODOT construction projects;
- Sample and test materials using appropriate devices and procedures;
- Furnish QL when required;
- Sample and provide splits to ODOT upon request, witnessed by an agency representative;
- Perform required tests on contractor's split of IA samples;
- Properly document, sign and deliver test results as required, on ODOT forms according to Section 3 criteria; and
- Retain splits of all QC samples until PM determines that the split samples may be discarded.
- Retain all split portions of IA samples until notified in writing by the Project Manager to discard.

Project Manager (PM)

The Project Manager has the authority and responsibility to enforce the provisions of the contract. The PM's Quality Control Compliance Specialist (QCCS) is involved with the project QA activities and is experienced and certified in all areas of field testing and documentation. The QCCS is required to maintain certification in CAgt, CEBT, CAT 1, CDT and QCT. Certification in CAT II, CCT and CMDT are recommended.

The Project Manager is responsible to ensure that:

- The project meets the requirements specified in the plans and specifications.
- All required tests are performed, documented, and submitted. The PM is also responsible for informing the QAC of project schedules, current quantities, and anticipated sampling requirements so verification testing can be accomplished.
- The contractor's QC program meets required standards. This is accomplished by performing inspections of contractor's personnel, testing procedures, and testing equipment.
- The contractor and Region Quality Assurance Laboratory is notified in writing within 5 working days of an IA/Verification sample's completion, as to which backup samples may be discarded or that an investigation is in progress. Upon the completion of an investigation inform the contractor, in writing, as to which backup samples may be discarded. Written notification will identify the Lot/Sublots, include the IA test results and if required the resolution of an IA investigation.

Region Quality Assurance Team

The Region Quality Assurance Team consists of a Quality Assurance Coordinator (QAC), Assistant Quality Assurance Coordinator and Quality Assurance Technicians (QAT). They are resources for the PMs, inspectors, technicians, other agencies, and contractors. They are also experienced in construction and design and certified in testing of construction materials.

Specific duties include, but are not limited to, the following:

- Maintain uniformity in construction and testing activities;
- Witness Quality Control Technician Sampling for IA and verification testing;
- Perform all required IA and verification testing;
- Properly document on ODOT forms according to Section 3 criteria;
- Calibrate or verify calibration of all nuclear moisture density gauges for ODOT, industry, and other agencies;
- Administer the Region's radiation safety program;
- Troubleshoot construction problems related to materials;
- Recommend changes to mix designs;
- Assist in the technician certification program;
- Oversee Region testing facilities;
- Inspect contractor facilities and/or technicians; and
- Assist in QC laboratory certification.
- Retain IA/Verification splits until notified by the PM.
- Administer the ODOT Approved Commercial Aggregate Product Program

Construction Section

The Construction Section's duties include:

- Support of the QA program by coordinating training and certification for technicians and by certifying all testing labs associated with ODOT construction projects;
- Administer the proficiency sample program;
- Provide third-party dispute resolution, according to the QA program.
- Utilize the QA Steering Committee to establish and ensure statewide consistency in the QA Program.

III. LAB CERTIFICATION PROGRAM

OVERVIEW

The Construction Section (CS) developed this laboratory certification program to support the Oregon Department of Transportation's (ODOT) Quality Assurance Program for Construction Materials. This program recognizes three categories of laboratories that will test materials for ODOT construction projects: Quality Control, Quality Assurance, and Dispute Resolution. To ensure that laboratories consistently provide quality test results, they shall be certified according to this Program.

PROGRAM DESCRIPTION

Quality Control Laboratories

Quality control of construction materials is the responsibility of the contractor. Laboratories performing quality control testing may be the contractor's own, the material supplier's or an independent testing laboratory.

The ODOT Central Laboratory will certify all Quality Control Laboratories for those test methods necessary to perform Quality Control tests of construction materials for ODOT construction projects. An outline of the on-site inspection process and laboratory certification criteria is found in the "On-Site Laboratory Inspection Criteria", Pg. 9. This certification will be valid for one year. If a laboratory's certification expires and the laboratory has a continued need to test materials for ODOT construction projects, the laboratory shall apply for re-certification.

This laboratory certification process is designed to provide a "snapshot" of the quality of a laboratory. The ODOT Central Laboratory or its authorized representative will examine the laboratory's testing equipment for accuracy and conformance to specifications. If the laboratory's equipment is properly calibrated and within specifications, and if the laboratory meets all other conditions specified in the Lab Certification Program and On-Site Inspection Criteria section, ODOT will certify the laboratory as competent and able to test materials for ODOT construction projects.

Quality Assurance Laboratories

Quality assurance is the responsibility of ODOT (the owner). Quality Assurance Laboratories perform Independent Assurance (IA) and/or Verification tests in coordination with Quality Control Laboratories performing quality control tests of materials for ODOT construction projects. This provides ODOT with an independent analysis of the quality control test results to ensure that the results of quality control tests are valid.

Quality Assurance Laboratories will usually be ODOT Region Laboratories, but may also be the ODOT Central Laboratory or an ODOT contracted independent testing laboratory.

Quality Assurance Laboratories perform Independent Assurance (IA) and/or Verification tests during production of materials. These laboratories perform a portion of the tests that the Quality Control Laboratories perform. The quality control and quality assurance test results are compared to each other to determine the reliability of the quality control testing program.

The ODOT Central Laboratory will certify all Quality Assurance Laboratories for those test methods necessary to perform quality assurance tests of construction materials for ODOT construction projects. This certification will be valid for one year. If a laboratory's certification expires and the laboratory has a continued need to test materials for ODOT construction projects, the laboratory shall apply for re-certification. An outline of the on-site inspection process and laboratory certification criteria is located under the "On-Site Laboratory Inspection Criteria" section, Pg. 9.

This laboratory certification process is designed to provide not only a "snapshot" of the quality of a laboratory, but also an evaluation of the laboratory's performance in maintaining quality and consistency. ODOT Central Laboratory inspectors will examine the laboratory's testing equipment for accuracy and conformance to specification. In addition, the quality assurance laboratory is required to participate in the ODOT Central Materials Laboratory Proficiency Sample Program, see Section V, Pg. 25. If the laboratory's equipment is properly calibrated and within specifications, and if the laboratory meets all other conditions specified in the "On-Site Laboratory Inspection Criteria" section, then ODOT will certify the laboratory as competent and able to perform independent assurance and/or verification tests of materials for ODOT construction projects.

Dispute Resolution Laboratories

When Quality Control and Quality Assurance test results conflict and the conflict cannot be resolved; a neutral Dispute Resolution Laboratory will test the material in question. The test results of the Dispute Resolution Laboratory will decide the dispute.

The ODOT Central Laboratory will perform all third party dispute resolutions unless a potential for conflict of interest exists.

In the event that the ODOT Central Laboratory acts as the Quality Assurance laboratory, and that the dispute is therefore between the Quality Control Laboratory and ODOT Central Laboratory, the ODOT Central Laboratory will defer its dispute resolution duties to a certified laboratory agreed upon between ODOT and the Contractor.

The ODOT Central Laboratory shall certify dispute Resolution Laboratories., other than the ODOT Central Laboratory.

Any Laboratory which has run Independent Assurance, Verification or Quality Control testing on the material under dispute is considered to have a conflict of interest and shall not perform Dispute Resolution on its own tests.

ON-SITE LABORATORY INSPECTION CRITERIA FOR QUALITY CONTROL AND QUALITY ASSURANCE LABORATORIES

A laboratory desiring information and/or an application package for ODOT laboratory certification may contact the ODOT Central Laboratory at the following address:

Oregon Department of Transportation
Construction Section, Materials Laboratory
Attn: Lab Certification Coordinator
800 Airport Road SE
Salem, OR 97301-4798
Telephone (503) 986-3087

Laboratories requesting ODOT certification shall make arrangements to receive an on-site inspection. Forms will be included in the application package to facilitate the laboratory's response to this requirement. These forms are available electronically at the following URL address:

ftp://ftp.odot.state.or.us/techserv/construction/QA_Certification/lab_app_pkt_cert.pdf

It is the responsibility of the requesting laboratory to have their lab clean, organized and in complete operating order at the time of inspection. All equipment must be readily available and accessible. The ODOT Laboratory Certification Team does not search for stowed equipment. In addition an authorized representative must be present at the time of inspection to answer questions or respond to identify and present equipment. Failure to meet this criterion or to find unorganized, unkempt facilities may result in a canceled inspection.

On-Site Inspection

The Lab Certification Inspector will visit each laboratory whose application for certification has been accepted. The laboratory inspector will evaluate the laboratory using criteria A through H listed below. A discussion of the criteria follows:

- A. **Requirement: The laboratory shall maintain facilities (fixed or mobile) for proper control of the laboratory environment.** This criterion is used to evaluate the laboratory's physical ability to provide an appropriate environment in which to test materials. General requirements include: the facility shall be physically able to function as a laboratory (e.g. adequate power, water, lighting, floor space etc.) and have the capability of maintaining temperatures that are specified in the test methods for which the laboratory is seeking certification.
- B. **Requirement: The laboratory shall maintain facilities for proper storage, handling, and conditioning of test specimens and samples.** This criterion is used to evaluate a laboratory's physical ability to store samples and keep them organized. The laboratory shall maintain separate areas on its premises to store samples and splits of samples in an organized manner so that samples are not lost or discarded and may be found at a future date. In addition, the laboratory shall have facilities for the conditioning of samples as required by any test method for which the laboratory seeks certification.

- C. **Requirement:** Calibration certificates held by laboratories shall meet the requirements of ISO/IEC 17025 and shall include appropriate statements of uncertainty. Laboratories shall use accredited calibration service providers. The laboratory shall maintain necessary calibration equipment and reference standards. A laboratory shall have, on hand, calibration and verification equipment necessary to ensure the accuracy of its equipment. Such equipment could include calibration weights for scales or balances; manometers for the verification of vacuum pumps; thermometers etc.
- D. **Requirement:** The laboratory shall maintain equipment conforming to specification requirements necessary for the testing performed. This criterion is used to ensure that the laboratory's testing equipment conforms to the specifications listed in the test methods for which the laboratory is seeking certification.
- E. **Requirement:** The laboratory shall demonstrate adequate care when recording and processing data and test results. This criterion is used to evaluate the laboratory's ability to produce accurate test reports. The laboratory shall have procedures in place that facilitate the timely and accurate recording of data and the ultimate accuracy of its test reports.
- F. **Requirement:** The laboratory shall demonstrate proper techniques for selection, identifying, handling, conditioning, storing, and retaining test samples. This criterion is similar to criteria B but is concerned with the laboratory's internal policies and procedures rather than its physical capabilities in regards to the above activities. The laboratory shall have policies and procedures in place to ensure that its personnel and technical staff have the ability to select, identify, handle, condition, store, and retain test samples as required by the test methods for which the laboratory is seeking certification.
- G. **Requirement:** The laboratory shall include the laboratory's name and address and the name(s) of the technician(s) performing the test(s) on their test reports. This criterion is used to ensure that the above information appears on the laboratory's test reports that are submitted to ODOT. In addition to the above, the technician(s) certification card number shall be entered on all test reports.
- H. **Requirement:** The laboratory shall have on site at the time of inspection and during production operations, a copy of the current MFTP and all equipment (except items listed as **mobile equipment**) necessary to perform the test methods for which they have requested certification. The ODOT Lab Certification inspection team has a Color Coded Tagging System, which identifies lab equipment that has met the certification criterion. The unique Colored Tag is valid for a 1 year period and starts from the date of the Final Report. (**Note: Not all testing equipment is tagged; reference the appropriate test procedure to identify required equipment.**)

Mobile equipment for additional test procedures may be added at a later date provided the following conditions are met:

- The laboratory must demonstrate adequate workspace and electrical system to operate required equipment.
- If equipment is new, they must provide copies of invoices that include the make, model and serial number of the equipment.
- If the equipment is rented or borrowed, it must come from another ODOT certified laboratory and provide the make, model and serial number as well as the number and color of the ODOT inspection tag.

Mobile Equipment

1. Ignition Oven
2. Gyrotory Compactor
3. Field concrete equipment

Preliminary Report

The ODOT Lab Certification Inspector will prepare a preliminary report of findings and present it to the laboratory manager at the conclusion of the on-site inspection. The preliminary inspection report will list all discrepancies for each test method in which the laboratory has requested certification. The inspector will discuss each discrepancy noted in the preliminary report with the laboratory manager in sufficient detail so that the laboratory manager understands the scope of the problem(s) and what corrective action is required in order to obtain certification for the test method(s) in question. When the inspector and the laboratory manager have covered all of the deficiencies, both parties will sign the preliminary report. These signatures indicate that both parties have read the report and understand its contents. The inspector will leave the original copy of the report with the laboratory manager and place a copy in the laboratory's permanent file.

The laboratory inspector will immediately (same or next day) FAX or hand delivers a copy of the report to the project manager and the region QA personnel for their files and general information.

Laboratories are expected to correct all deficiencies within thirty-days so that a certification may be issued. If a laboratory needs more than thirty-days to correct deficiencies, the laboratory shall notify the laboratory inspector, in writing, explaining why they need additional time. The laboratory will not be certified until all deficiencies are corrected.

If the ODOT Lab Certification Inspector within the thirty-days receives no response to the preliminary report allowed, then the laboratory will be immediately decertified until the deficiencies are corrected or a written response has been received.

Final Report

Once all of the deficiencies have been corrected the ODOT Lab Certification Inspector will prepare a final report of findings and mail it to the laboratory.

The laboratory inspector will mail copies of the final report to the project manager and the region QA office.

Certificate of Laboratory Certification

The ODOT Central Laboratory will prepare a Certificate of Laboratory Certification for a laboratory when the laboratory has met the requirements listed in “On-Site Laboratory Inspection Criteria”, Pg. 9, and has corrected all deficiencies noted by the inspector. The certificate will be mailed to the laboratory with the final report of findings. The Certificate will include the type of certification, laboratory name, test methods the laboratory has been certified to perform, color of the inspection tag and the Construction Section Manager’s signature. This Certificate is proof of a laboratory’s ODOT certification for the listed test methods and may be presented as such to any ODOT project manager.

The laboratory inspector will mail copies of the Certification with the final report to the project manager and the region QA office.

Certificates of Laboratory Certification are valid for one-year from the date of the inspection.

Follow Up On-Site Inspections

If at any time during a laboratory’s term of certification, the project manager or region QA personnel suspect that any of the contractor’s laboratory equipment, conditions outlined under Requirement H or the laboratory building itself are out of specification, the project manager or region QA personnel may request an additional on-site inspection. The project manager or region QA personnel will contact the Lab Certification Inspector and schedule the follow up on-site inspection.

If the follow up on-site inspection reveals that the laboratory is deficient in one or more areas, the laboratory inspector will immediately decertify the laboratory for those test methods affected by the deficient equipment or facilities. The laboratory inspector will recertify the laboratory following correction of all deficiencies. A laboratory may not perform materials tests using test methods for which it has been decertified.

Laboratory Decertification

A Quality Control or Quality Assurance Laboratory may have its entire certification or its certification for specific test methods revoked by ODOT if it is found to not conform to the specifications and standards of its ODOT certification. A laboratory that has had its certification revoked for a specific test method(s) may not test materials that require the use of such revoked test certification(s). A laboratory that has had its entire certification revoked shall promptly cease testing materials for ODOT construction projects.

A laboratory that has had its certification partially or entirely revoked may seek reinstatement by demonstrating conformance to the ODOT Laboratory Inspection requirements.

In addition, any laboratory/company intentionally misrepresenting the status of their certification or falsifying test results will be subject to disciplinary action up to a one-year suspension of their certification. Any allegation regarding the practices of a certified laboratory will be made in writing to the Certification Advisory Committee. The Certification Advisory Committee will investigate the complaint and take appropriate disciplinary action. In all cases, the parties involved in the complaint will be provided an opportunity to appear before the committee before any actions are taken.

IV. TECHNICIAN CERTIFICATION PROGRAM

INTRODUCTION / BACKGROUND

The Oregon Department of Transportation's Quality Assurance Program requires all personnel and laboratories performing testing on ODOT projects to be certified. The level of certification is dependent on the specific type of testing to be performed. The Certification Advisory Committee, described in Section I, Pg. 3, of the QA Program, will provide approval and general oversight for the certification programs. Specific direction and administration of the individual certifications will be provided by ODOT unless other groups are specifically referenced in the description of the individual certifications.

The Oregon Department of Transportation is a member of the Western Alliance for Quality Transportation Construction (WAQTC), which consists of 11 western states committed to the quality of our transportation systems. WAQTC has developed a technician-training program, which is comprised of instructional, and student modules used to assist in the training process of material field-tested procedures. ODOT has adopted the training packages for all certifications except for ODOT specific certifications and those controlled by entities other than WAQTC such as QCT, CCT, CMDT and CAT II.

The purpose of the Technician Certification Program is to ensure technicians performing testing have a minimum level of knowledge in the area of certification.

Technician Certifications

Following is a summary of the approved Technician Certifications and the associated certification durations:

Certification Discipline	Initial Certification	Renewal of Certification
CSTT	5 years	5 years
CCT	3 years	3 years
CMDT	3 years	*3 years
CAT-II	3 years	3 years
CAgt	3 years	5 years
CEBT	3 years	5 years
CDT	3 years	5 years
CAT I	3 years	5 years
ACI Grade 1	5 years	5 years
QCT	Concurrent with ACI Grade 1	

*To be eligible for CMDT recertification by taking only the recertification exam, the technician must have:

- Submitted a minimum of one dense ACP mix design meeting the requirements of the Contractor Mix Design Guidelines and ODOT TM 330, for each year of certification and
- Participated in the CMDT Proficiency program for each year following the initial certification year.

Certified Aggregate Technician (CAgT):

A CAgT performs a variety of tests on soils and aggregates including; sieve analysis, fracture, sand equivalency, and other tests. A CAgT also performs other duties as required by current specifications for soils and aggregate materials.

Certified Embankment and Base Technician (CEBT):

The CEBT performs testing of soils and aggregates for establishing the relative maximum density and optimum moisture for use in compaction testing of sub grade soils and aggregate bases. A CEBT also determines the Specific Gravities of aggregate.

Certified Density Technician (CDT):

A CDT performs in-place density testing of soils, aggregates, and asphalt mixtures using the nuclear density gauge. In addition to certification, a CDT must be in compliance with state and federal training regulations, and state and federal regulations concerning radioactive materials as administered by their company's RSO. For soil, soil aggregate mixtures, and aggregates a CDT determines percentages of coarse and fine material, performs one point testing and related calculations.

Certified Asphalt Technician I (CAT-I):

A CAT-I performs sampling and testing for ACP and EAC mixtures including AC content, maximum specific gravity, sieve analysis, void measurements, and other tests and duties as required by current specifications.

Certified Asphalt Technician II (CAT-II):

A CAT-II is responsible for managing the volumetric properties of asphalt mixes by controlling plant operations, for troubleshooting ACP sampling and testing processes, and for making appropriate adjustments to ACP production and lay down procedures. **Certification at CAT-II level is contingent on having successfully completed the CAT-I certification phase at least once.**

Certified Mix Design Technician (CMDT):

A CMDT is responsible for preparing ACP and EAC Mix Designs, including all material testing and data analysis necessary to properly complete a design. A CMDT prepares designs for both dense and open graded mixtures.

Quality Control Technician (QCT):

A QCT performs testing of fresh Portland cement concrete including sampling, concrete temperature, slump, unit weight, air content, and fabrication of specimens for strength testing and performs other duties including calculating cement content and water-cement ratio as required by specifications.

QCT certification is obtained through the ACI Concrete Field Testing Technician - Grade 1 certification program, with the Oregon written Supplemental test, conducted by the Oregon Concrete and Aggregate Producers Association (OCAPA). QCT is only valid while the ACI Concrete Field Testing Technician – Grade Level 1 is valid.

Concrete Control Technician (CCT):

A CCT is responsible for preparing concrete mix designs. Proportioning concrete mixtures to meet job requirements, and for making adjustments to the mix design as necessary to provide a concrete mixture of the quality required by specifications. A CCT certification is obtained through a training program conducted by OCAPA.

Concrete Strength Testing Technician (CSTT):

A CSTT is responsible for testing the compressive or flexural strength of hardened concrete cylinders or beams. The duties of a CSTT include proper capping of specimens (bonded and un-bonded), correct operation of breaking device and visual evaluation of broken specimens. Also, the CSTT is responsible to insure the proper handling, mold removal, logging and curing of field fabricated samples upon arrival at the laboratory. A CSTT certification may be obtained through a program conducted by Oregon Chapter of the American Concrete Institute.

Who Must Be Certified?

For all projects which the Quality Assurance Program applies, all personnel responsible for performing sampling and testing must be certified. All personnel performing the Quality Control Compliance Specialist duties of reviewing test reports whether working for ODOT, a Contractor, a Consultant or for Local Agencies must be certified.

Certification Requirements

To obtain any of the above certifications, the technician will be required to pass a written and/or a practical test demonstrating a knowledge and understanding of how to perform the specific tests and of specifications applying to the material being tested. All tests shall be administered and evaluated only by evaluators approved by the Certification Advisory Committee Chair, or their designated representative.

To apply for the certification, the applicant will register either for one of the approved training classes, where the exam will be administered as part of the class, or submit an application to challenge the exam. The challenge applications will be submitted through the approved training program to facilitate scheduling. Appropriate fees will be charged for the challenge exams to cover scheduling, overhead and facility use. Applicants will be scheduled for examination through a cooperative effort between ODOT and the appropriate training program service provider.

All certifications shall be contingent upon the technicians signing a rights and responsibilities agreement. This agreement outlines the technician's rights and responsibilities along with the possible consequences of the abuse and/or neglect of these responsibilities. The technician will submit a signed agreement at the time they take the certification examination.

Examination Process

The Asphalt Paving Association of Oregon (APAO) and Oregon Concrete Aggregate Producers Association (OCAPA) currently perform the instructional phase, while ODOT maintains the certification and administration of the written and practical exam processes. The certification system is made up of three phases. Phase one - WAQTC written exam, phase two - ODOT written exam and phase three - combined ODOT and WAQTC performance exam.

During the exam process, only hand calculators are allowed, the use of computers is not permitted during any exam phase.

Challenge Process

A person may challenge the exam process if they feel that they have the knowledge and skills to be able to pass without attending formal training. If the person does not currently possess a certification for that specific discipline and fails any of the following mentioned examination events, then that person must attend the formal training for that certification. If the person currently possess a certification for that specific discipline and fails any of the following mentioned examination events, then that person may challenge the failed examination event for that certification a second time. If the person fails the challenged event a second time, then the person must attend formal training for that specific discipline.

WAQTC Written Examination

- a. Closed Book
- b. Consists of multiple modules, depending on the needed certification
- c. Each module consists of 5 questions with multiple choice, true or false, and required calculations.
- d. Written exam time lines vary depending on the needed certification. 1 to 1 ½ hours is given to complete the exam.

ODOT Written Examination:

- a. Open Book
- b. Consists of multiple choices, true or false, and essay questions related to test procedures as well as specifications and completion of various ODOT forms.
- c. Written exam time lines vary depending on the needed certification. 3 to 3 ½ hours is given to complete the exam.
- d. For CMTD certification, there are two written exams covering Dense and Open graded ACP, EAC and Aggregate Treatment applications. 4 hours is allowed for the Dense ACP exam and 2 hours for the Open ACP, EAC and Aggregate Treatment exam.

ODOT /WAQTC Combined Performance Examination

- a. Each participant will demonstrate proficiency in the designated test methods with prepared samples and will demonstrate the ability to apply specifications and ODOT specific requirements to the needed test and identify the quality of the material being tested.
- b. The exam is open book but the technician may not use the performance exam checklist.

- c. The performance examination for ODOT is performed in conjunction with the WAQTC performance exam. 4 ½ hours is given to complete the performance exam process with 4 hours actual lab time and ½ hour given to complete calculations. The performance exam answers are graded based on completion of the required tests, accuracy of computations, application of the correct specifications, and the results of computations meeting the parameters set forth in the Independent Assurance Parameters section of the Quality Assurance Program.
- d. During the performance exam the examinee may be asked to explain various steps of a procedure to reduce the full test time.
- e. The performance exam checklist consists of yes and no blocks. In order to complete the checklist successfully, all of the yes blocks must be filled out.

In the event, a participant fails the first attempt; a second attempt is given, if time permits, and after the exam proctor explains the correct procedure. Anyone failing a test method on the performance exam may repeat that trial during the day of the performance exam, depending on the timelines and the type of test. Repeat trials will be allowed in not more than 50% of the total test methods in that performance exam. If the participant fails on the second attempt the performance exam will stop and the participant will have to re-take the exam at the scheduling convenience of the Agency.

Passing Score – Written

- a. Initial exam (first attempt) WAQTC: An overall score of 70% with a minimum of 60% on any one-test method.
- b. Re-exam (second attempt) WAQTC: An initial exam overall score below 70% will require a re-exam on all test methods. An initial exam score above 70% overall, but below 60% on one or more test methods, will require a re-exam on only those test methods. In the case of one test method comprising the re-exam, the examinee must receive a score of 70%. In the case of more than one test method comprising the re-exam, the examinee must receive an overall score of 70% with a minimum of 60% on any one-test method.
- c. Initial exam (first attempt and second attempt) ODOT: An overall score of 70% is required to successfully complete the exam requirement.
- d. Initial exam (first attempt) ODOT exam of:
 - QCT supplemental an overall score of 80% is required to successfully complete the exam requirement.
 - For the CCT and CMDT certification exams, an overall score of 75% is required to successfully complete the exam requirement.
 - Re-exam (second attempt) for the ODOT QCT, CMDT and CCT exam the participant must meet the same criteria as the Initial exam first attempt.

Passing Score – Performance

- a. All performance checklists must have 100% yes blanks checked and each test method must be performed within the designated time limit. Each examinee is allowed two attempts to complete procedures if time allows.

- b. First attempt: Performing all the required tests, application of correct specifications and meeting the Independent Assurance Parameters is required to receive a pass rating. The grading is based on pass/fail of all associated tests performed under the desired certification.
- c. Second attempt: The same criteria as the Initial exam must be met.
- d. For CMDT, an acceptable Level 2, 3 or 4 ACP design must be submitted along with verification materials, as described in Section 6 of the most recent edition of the “Contractor Mix Design Guidelines for Asphalt Concrete”. A six-month period will be allowed for the mix design submittal from the date of the written exam.

Re-examination Policy – Written/Performance

Failure of any exam phase a second attempt will require attendance of the course for that qualification and passing the exam element failed on the second attempt if certification is still desired. In addition, on the date the certification exam was first taken a technician will have 120 days to complete the exam requirements for the desired certification. If the exam requirements are not met within the 120-day period and certification is still desired the technician will be required to perform the entire exam process again.

Applicants with Disabilities or Special Needs

Applicants with a disability or those having special needs should notify the Certification Advisory Committee Chair, or their designee, at the time application is made of what appropriate accommodations need to be made so that these can be planned for.

Disclaimer

Certification of an individual by the ODOT Technician Certification Program indicates only that the individual has demonstrated a certain level of competence on a written and/or practical examination in a selected field of activity. ODOT may require this certification of individuals performing activities specified in work contracts or other activities. ODOT and the Certification Advisory Committee make no claims regarding the abilities or competence of certified individuals. Each individual or organization utilizing certified individuals must make its own independent judgment of the competence of certified individuals. ODOT specifically disclaims any responsibility for the actions, or the failure to act, of individuals who have been certified through the ODOT Technician Certification Program.

To obtain certification may involve hazardous materials, operations and equipment. This program does not purport to address all safety or regulation concerns associated with the use of the procedures used. It is the responsibility of the users to use and establish appropriate safety and health practices and determine the applicability of regulatory limitations.

Documentation of Certification

Upon the successful completion of the examination(s), the participant’s name, home address, and/or company affiliation is registered in the official registry of certified technicians for the appropriate certification. ODOT Construction Section maintains the official registry. It is accessible on the internet at the following address:

<http://highway.odot.state.or.us/cf/techcertdynamic/>

It is anticipated that many technicians will hold multiple certifications. An official letter(s) indicating certifications(s) held will be provided after successful completion of the certification process.

Recertification

To remain current, a Certified Technician must obtain recertification before the expiration date of the certification. Recertification may only be obtained by passing the written and/or practical test required for that particular certification. A Certified Technician must apply for the individual certification for which they want to remain certified. The Certified Technician is responsible for scheduling his/her own written and/or practical comprehensive examination.

It should be noted that should a technician fail to successfully complete a Certification renewal in a specialty area, the technician will be considered disqualified in that area, only, until the requirements for Certification renewal have been successfully met, subject to the limitations set forth in this document.

Note: A certification extension may be provided upon written request to the QAE. The request should contain the reason for the extension, desired certification, and proof of future class attendance or challenge process through a registration of the training provider.

The length and conditions of any extension will vary and are at the discretion of ODOT.

Revocation or Suspension of Certification

The Certification Advisory Committee Chair for just cause may revoke technician Certifications at any time. Proposed revocations are sent to the individual in writing along with the individual's right to appeal the proposed revocation. A proposed revocation is effective upon receipt by the technician and will be affirmed, modified, or vacated following any appeal.

The reasons that certified technicians will be subject to revocation or suspension of their certifications are *negligence* or *abuse* of their responsibilities. The Certification Advisory Committee (CAC) may disqualify certified technicians for other reasons of just cause, which may or may not be specifically defined herein following the due process procedures outlined herein.

Negligence is unintentional deviations from approved procedures that may or may not cause erroneous results. The following penalties are guidelines for findings of *negligence*: The first finding of *negligence* will result in a letter of reprimand being sent to both the employee and the employer. Depending on the nature of the incident, the CAC could impose up to a 30 day suspension. The second significant incident during the certification period will result in the Quality Assurance Engineer (QAE) discussing the issue with the individual and their employer to establish a corrective action plan. Depending on the nature of the incident, the CAC could impose up to a 180 day suspension. The QAE will also notify the entire ODOT Quality Assurance staff of the issue. A third instance of neglect may result in permanent revocation of the Certification.

Abuse is knowingly deviating from approved procedures or when the technician should have known they were deviating from approved procedures. There are two levels of severity for *abuse*.

For level 1 *abuse*: The first finding may result in up to a 180-day suspension all of the Certifications of the individual. A second instance (within the certification period) would result in a minimum of 180-day suspension of all certifications.

For level 2 *abuse*: the first finding will result in a 1-year suspension of all Certifications of that individual. A second finding will result in permanent revocation of all Certifications.

Revocations or suspensions for *abuse* or *negligence* in one Certification area are considered revocations or suspensions in *all Certifications* held by the technician.

Allegations of *negligence* or *abuse* are made to the Quality Assurance Engineer (QAE) in writing. The allegations will contain the name, address, and signature of the individual(s) making the allegation. The QAE will investigate all allegations. The QAE will decide if the incident is significant to warrant review by the Certification Advisory Committee (CAC). If the incident is given to the CAC for review, then the accused and the individual(s) making the allegation are given the opportunity to appear before the CAC to present any appropriate information. Within a 60 day period, all involved parties will receive a report of the findings in writing. Any warranted penalties will be imposed in accordance with guidance contained herein and according to the guidelines outlined under the Technician Compliant Process. Decisions regarding allegations of *negligence* or *abuse* may be appealed in writing to the Committee Chair. The Committee Chair will independently consider such written appeals but may rely on the advice and counsel of the Committee.

In all cases, the CAC will conduct the investigation into the allegations and make a recommendation to the ODOT Construction Engineer as to appropriate sanctions against the technician. All final decisions regarding suspension of certifications will be up to the ODOT Construction Engineer.

Because ODOT is a member of the Western Alliance for Quality Transportation Construction, the Certifications are honored by other member states. The Certification Advisory Committee will notify the other members of the WAQTC, or other participants in the TTQP, of anyone having a Certification revoked or suspended.

TECHNICIAN COMPLAINT PROCESS

The Oregon Department of Transportation’s Technician Certification program is intended to assure qualified personnel are performing all materials testing for ODOT construction projects. In addition to certified technicians, the department needs a means to address concerns that are raised regarding those technicians not following approved procedures. The Technician Complaint Process will provide guidance on how to deal with these concerns.

It should be understood that the intent of the process is to resolve differences of opinion on appropriate procedures at the lowest possible level. Technicians are encouraged to work together to resolve any differences they might have.

Only when those issues cannot be resolved at the project level should they be raised to the level of filing an official complaint. It should be understood that in no way is the formal complaint process intended to remove any authority the Project Manager may have under an existing contract.

Any individual may file a complaint regarding testing procedures or practices. The first step when filing a complaint is to decide whether the issue is a case of “Neglect” or “Abuse”. “Neglect” is unintentional deviations from approved procedures. “Abuse” *Abuse* is knowingly deviating from approved procedures or when the technician should have known they were deviating from approved procedures. The appropriate process for dealing with the issue is followed after a decision is made on the type of offence. The following pages outline the process for dealing with both Neglect and Abuse:

Complaint Process for Neglect

Again, neglect is much less severe than abuse and individuals are encouraged to resolve their differences at the project level so the project can continue forward in a positive fashion. The complaint process for neglect is intended primarily to allow a means of tracking the types of problems being encountered and also to look out for technicians who seem to have repeated instances of neglect.

Step 1: When an individual discovers a significant problem with a technician’s procedures or testing process, that individual will personally point out the concern to the technician. The two individuals will work together to try to resolve the issue. They may need to refer to the Manual of Field Test Procedures or other contract documents to verify proper procedures.

If the two can agree on corrective action, the issue can be resolved at their level. If not, the Region QAC should be contacted for clarification. If discrepancies on correct procedures still exist, the issue will be brought to the ODOT Quality Assurance Engineer (QAE) for resolution.

Step 2: Once the problem is resolved, the individual who discovered the problem will send a short memo to the QAE describing the issue and the resolution.

Depending on the severity of the issue, the QAE may send a letter of reprimand to the technician and their employer and the CAC could impose up to a 30 day suspension.

Step 3: If a second significant incident is reported within the certification period for a specific technician, the QAE will discuss the issues with the technician and their employer and establish a corrective action plan to help the technician avoid further complaints. Depending on the nature of the incident, the CAC could impose up to a 180 day suspension. In addition, the CAC could require the technician to attend additional training and retake the particular certification exam before reinstatement as a certified technician. The QAE will also send out notice to all ODOT Quality Assurance staff of the issue. This notification is intended to help put ODOT staff on notice of particular problems being encountered.

Step 4: If a third instance of neglect is reported within the certification period, the specific technician and his/her employer must meet with representatives from the Certification Advisory Committee (CAC) to discuss the issues.

The technician will be responsible for providing a plan of how they will correct their deficiencies and assure no further instances will occur. The CAC may gather further information to substantiate the claims. The CAC will review the information and could impose up to permanent revocation of the certification in question.

It should be noted that because of the potential for repeated offences of neglect, the CAC could at any point in the process make a determination that the successive instances no longer fit as neglect, but because of the repeated nature of an offense, may become an instance of abuse. If this occurs, the issue would be dealt with through the complaint process for abuse.

Complaint Process for Abuse

Because abuse is defined as intentional, the process for dealing with instances of abuse will be more formal and penalties more severe than for instances of neglect.

Step 1: If abuse is suspected, the issue shall be raised immediately to the ODOT Quality Assurance Engineer (QAE). The QAE will investigate the issue and make a preliminary determination on whether it actually is abuse or neglect. If the issue is determined to be abuse, move to step 2 below. If it is determined to actually be a case of neglect, move to step 1 of the process for dealing with neglect.

Step 2: The QAE will gather information regarding the incident from both the technician involved as well as the individual filing the complaint. The QAE will review the information and determine whether the incident is significant to warrant review by the Certification Advisory Committee (CAC). This review will be completed within 60 day of receipt of the complaint. If the incident is determined to be “significant” the issue will be put on the agenda for the next CAC meeting.

Both the technician and the individual filing the complaint will be invited to attend the meeting to present any appropriate information. Insignificant issues will be handled directly by the QAE and a summary of the incident will be submitted to the CAC for their review.

Step 3: The CAC will determine the merits of the complaint and also the severity level of the abuse. Abuse will be identified as one of two different levels of severity.

Level 1 being identified as the least severe form of abuse. This level is identified as knowingly deviating from approved procedures or when the technician should have known they were deviating from approved procedures. The key component for Level 1 Abuse is there is no misrepresentation the quality of material being incorporated in the project. This level of abuse could result in up to a 180 day suspension of all certifications held by the technician. The exact duration of the suspension will be set by the CAC depending on the circumstances encountered. A second instance (within the certification period) of Level 1 abuse would result in a minimum 180 day suspension of all certifications.

Level 2 abuse is much more severe. The distinguishing component of Level 2 Abuse is misrepresentation of the quality of material being tested. This level of abuse will be dealt with by a 1-year suspension of all certifications for the technician. A second instance of level 2 abuse will result in permanent revocation of all certifications.

Record Retention

Investigations, supporting exhibits, letters of expectation, CAC recommendations and other investigative correspondence will be kept on file according to the following guidelines:

- Negligence – records will be kept for a 5 year period starting on the date of the investigation.
- Abuse – records will be kept permanently.

At any time retained records may be used to support further allegations of negligence or abuse.

V. QUALITY ASSURANCE LABORATORY PROFICIENCY SAMPLE PROGRAM

OREGON DEPARTMENT OF TRANSPORTATION CONSTRUCTION SECTION

Proficiency sample testing is an additional factor used to evaluate the performance of a Quality Assurance (QA) laboratory and the Quality Assurance (QA) laboratory technicians. It provides information not otherwise available from the on-site laboratory inspection (Section III, Pg. 9) and a means of continued monitoring of testing personnel and testing equipment. The ODOT Construction Section requires QA Laboratories and QA laboratory technicians to participate in this Proficiency Sample-testing Program. Participation includes testing all applicable samples, which are to be distributed and completed within the specified time frame. The resulting data is analyzed by the ODOT Quality Assurance Engineer.

Proficiency samples are distributed by Construction Section at annual intervals as outlined in the Proficiency Sample Testing Plan in Table 1 of this Section. The Construction Section will distribute a minimum of one set of samples from each material test method listed in Table 1 for each of the QA laboratory technicians. The ODOT Central Laboratory and the QA laboratory technicians will perform the required testing listed in Table 1 on each set of samples. The distribution of proficiency samples is not intended to coincide with the on-site laboratory inspection. Proficiency Sample test results will be submitted to the Quality Assurance Engineer within 30 days of receipt of the sample. The results will tabulate all of the testing results from the ODOT Central Laboratory and the QA laboratory technicians and statistically evaluate if any of the technician results are more than two standard deviations beyond the grand average value for each test method.

When a QA laboratory technician results are beyond two standard deviations of the grand average values, the Quality Assurance Coordinator (QAC) shall investigate the reason for the discrepancies and report the findings and actions taken to the ODOT Quality Assurance Engineer (QAE) within thirty days of issuance of a final report. The QAE will determine whether or not the findings warrant further action to address the testing deviations and identify steps that need to be taken to ensure that the technician is correctly performing the test. The QAE will be responsible for monitoring the technician testing results until there is confidence that the technician is following approved procedures.

When an ODOT Central Lab technician results are beyond two standard deviations of the grand average values, the ODOT Laboratory Services Manager shall investigate the reason for the discrepancies and report the findings and actions taken to the ODOT Quality Assurance Engineer (QAE) within thirty days of issuance of a final report. The QAE will address the testing deviations, identify steps to be taken, and be responsible for monitoring results in the same manner as for a QA laboratory technician.

If a QA laboratory technician or ODOT Central Lab technician exceeds the two standard deviation limit on the next year's Proficiency Samples for the same material test method and is not able to provide the QAE with a satisfactory explanation for exceeding the limits; the technician will immediately perform a backup proficiency sample witnessed by the QAE or designated representative. The QAE will review the process that was followed from the previous year's investigation findings and make a determination if the technician is not following approved procedures. If the QAE finds that the technician is not following approved procedures the QAE will immediately suspend the technician from performing any QA project work or third party dispute resolution work involving the test method that has been identified. The QAE will identify what steps are necessary to allow the technician to resume testing for the failing test method.

TABLE 1 – PROFICIENCY SAMPLE TESTING PLAN

January Distribution

TEST METHOD
SOIL & Aggregate Sample
Bulk Specific Gravity – AASHTO T 85
Coarse Particle correction – AASHTO T 99
Max. Density – AASHTO T 99 Aggregate Base
Max. Density – AASHTO T 99 Soil
Sieve Analysis – AASHTO T 27/11
Sand Equivalent – AASHTO T 176
Fracture – AASHTO T 335
Wood Particles – ODOT TM 225
Elongated Pieces – ODOT TM 229
ACP Mixture Sample
Bulk Specific Gravity – AASHTO T 166, Method A
Max. Specific Gravity – AASHTO T 209
AC Content by Incinerator – AASHTO T 308
Mechanical Analysis of Extracted Aggregate- AASHTO T30
Fabrication of Gyratory Specimen – ODOT TM 326

A laboratory may obtain additional information on the Construction Section's proficiency-testing program by contacting the Construction Section at the following address:

Oregon Department of Transportation
 Construction Section, Materials Laboratory
 Attn: Quality Assurance Engineer
 800 Airport Road S.E.
 Salem, OR 97301
 Telephone (503) 986-3061

VI. PRODUCT SPECIFIC QC/QA TESTING PLAN

The Quality Assurance Program consists of three distinct sub-programs. The Quality Control Program, the Verification Program and the Independent Assurance Program. This Section provides specific details on how these programs work together to assure specification materials are incorporated into ODOT projects. It also provides details on specific requirements of each of the programs for each of the materials, which are utilized on ODOT projects.

In general, contractor's quality control tests are obtained at the highest frequency. Agency verification tests are run usually on a minimum frequency of 10%, of subplot quantities identified in section 4(D) of the MFTP. While the Independent Assurance program takes steps to assure the quality of both the QC and the verification test results.

ODOT will accept materials based on the contractors QC test results only if verified by the Agency verification testing. Verification of QC test results will require all of the following conditions to be met:

1. The Department's testing results show that the material meets the specified quality.
2. The split samples meet Independent Assurance parameters.
3. The Department's Verification test results compare reasonably to the ongoing Quality Control data.

If any of the above conditions are not met, an investigation will be conducted by the Project Managers office to determine whether to reject the material or if the material is suitable for the intended purpose according to section 150.25 and also what price adjustment might be applied. See Investigation Criteria for details and requirements.

Step 2 in the above conditions compares the contractor's test results on the split IA sample to the agency results. The Independent Assurance Parameters to be used for the comparison are listed in Table 1 of this Section.

The following pages detail the Investigation Criteria, Quality Control, Verification and Independent Assurance requirements for each of the specific materials used on ODOT projects.

Investigation Criteria

The intent of the investigation is to determine reasonable cause for the discrepancy and provide supporting documentation of materials failing to meet the conditions outlined for Verification, Independent Assurance and prior Quality Control testing. An investigation is required for all materials failing to meet these conditions because of the potential impact on the quality of the material produced or incorporated into the project.

Several resources are available to assist with the troubleshooting process and data collection. Appendix C, Pg. 50 (Troubleshooting Guide) provides some guidance through the evaluation phase based on material discipline and the associated tests. The guide is an evaluation tool and is not necessarily a complete listing of all potential areas to be investigated and the assistance of the Region QAC, QAE or other technical resources is encouraged.

The investigation and the resolution of the discrepancy shall be documented on form (734-4040) and at a minimum will contain the following information:

- Clearly explain the issue under investigation. Provide the bid item number, material description, test procedure or process in question, associated Quality Assurance testing reference's and date or timelines of the testing issue.
- Describe the steps taken to resolve the discrepancy and the associated information or test results gathered to support the findings.
- Provide a conclusion based on the findings.
- Describe recommendations or actions to be taken.
- Provide written notification to the QAC and Quality Control entity upon completion of the investigation. Ensure a copy of the investigation is maintained in the project files.

INSERT TAB

**SECTION IA
Parameters**

TABLE 1
Independent Assurance (IA) Parameters
Maximum Allowable Differences

Gradation (Sieve Sizes with Assigned Tolerances)

Larger than No. 8	5%
No. 8	4%
No.10	4%
Larger than (No. 200) and smaller than (No. 10)	2%
No. 200 with targets 10.0% or less	1.0%
No. 200 with targets greater than 10.0%	1.5%
Asphalt Content	0.40%
Fracture	5%
Wood Particles	0.05%
Elongated Pieces	5:1 Ratio (2.0%) & 3:1 Ratio (4.0%)
Sand Equivalent	8 points
Moisture Content (Plant Mix Aggregate Base)	1%
Soil Curves - Maximum Density - D_r	
<i>Density</i>	3.0 lbs/ft ³
<i>Moisture</i>	3.0%
Aggregate Base - Maximum Density - D_r	
<i>Density</i>	3.0 lbs/ft ³
<i>Moisture</i>	2.0%
Maximum Specific Gravity (Rice T-209)	
<i>Standard (G_{mm})</i>	0.020
<i>Dryback (SSD) "As required"</i>	0.020
Bulk Specific Gravity (Lab fabricated specimens T-I66)	0.032
Maximum Specific Gravity (T-85)	0.032
Air Content of Concrete (T-152)	0.5%
Slump of Concrete (T-119)	¾"
Temperature of Concrete (T-309)	3° F
Unit Weight of Concrete (T-121)	3.0 lbs/ft³

AGGREGATE PRODUCTION

Quality Control	Verification	Independent Assurance
Required	Required	Required

Quality Control

The ODOT Central Materials Laboratory will retain Quality Control of source/product compliance as stated in Section 4(A). The Contractor's QC technician shall sample the aggregates, place the sample in a proper container and label as specified in Section 4(C), complete *ODOT Sample Data Sheet* (Form 734-4000), and deliver to the PM.

The Contractor's QC technician shall establish a random sampling and testing program and submit it to the PM prior to the start of production.

The Contractor's QC technician shall perform Quality Control sampling and testing required to ensure a quality product at the frequencies indicated in Section 4(D) of MFTP. The Contractor shall deliver the test results to the PM by the middle of the following work shift.

Pre-produced aggregates shall be tested at the frequency applicable for the material and use as determined by the appropriate specifications(s) and Section 4(D) of the MFTP. (i.e. a 20,000 ton stockpile of aggregate base will require 10 QC tests and 1 QA test).

The Contractor is responsible for furnishing Quality Levels during aggregate production when specified. The Contractor's QC technician shall reject material that does not meet the specified quality and notify the PM of the disposition and quantities of those materials. All required tests, except for gradation, are considered pass/fail. *Gradation is subject to statistical analysis as described in specifications Section 00165.*

Backup samples for aggregates shall be a minimum of 1/2 the minimum mass shown in Table 1 of AASHTO R 90 for the appropriate Nominal Maximum size aggregate.

Verification

The QAC performs Verification tests, taken randomly, according to the Manual of Field Test Procedures Acceptance Guide (Section 4(D)). A split of the sample taken by QC will be given to the QAC for testing.

If Verification testing fails to meet the specifications, other than gradation, the QAC will immediately notify the PM. The PM will evaluate the results and resolve the discrepancy.

If Verification test results indicate that a material is out of specification for gradation, the QAC will notify the PM, who will determine if the stockpile QL meets the specifications. The PM will determine if the stockpile is acceptable.

Independent Assurance

All parties that test materials shall employ ODOT-certified technicians and use ODOT-certified laboratories.

The Contractor's QC technician shall test the Contractor's split of IA samples and provide the results to the PM the next workday. The PM will verify that the Contractor's test results and the QAC's test results are within IA parameters.

If the Contractor's test results and the QAC's test results for IA samples are not within IA parameters, the PM will evaluate the results and resolve the discrepancy. See Investigation Criteria.

EARTHWORK

(Section 00330)

ESTABLISHING MAXIMUM DENSITIES

<i>Quality Control</i>	<i>Verification</i>	<i>Independent Assurance</i>
Required	Not Required	Required

Quality Control

The Contractor's QC technician is responsible for establishing maximum densities and optimum moisture content for each unique soil type and soil/aggregate mixture incorporated into the project. *Backup samples shall be a minimum mass of (45 lbs) and retained until notified by the PM to discard.*

Verification

None Required

Independent Assurance

All parties involved in the testing process shall employ ODOT-certified technicians and use ODOT-certified laboratories.

The QAC will test the Contractor's split of the soil sample and provide the results to the PM within a 48 hr. period, based on the time the sample was split. The PM will verify that the Contractor's test results and the QAC's test results are within IA parameters.

If the Contractor's test results and the QAC's test results are not within IA parameters, the PM will perform an investigation (see Investigation Criteria) evaluate the results and resolve the discrepancy.

COMPACTION

<i>Quality Control</i>	<i>Verification</i>	<i>Independent Assurance</i>
Required	Required	Required

Quality Control

The Contractor's QC technician shall establish a random sampling and testing program.

The Contractor’s QC technician shall be on the project during performance of earthwork operations, as needed, to ensure that materials/products are in conformance with the specifications. The QC technician’s duties include, but are not limited to, visual observation, sampling and testing. The Contractor shall rework all areas showing visual deflection. Sampling and testing procedures shall be performed at the frequencies indicated in Section 4(D) of the MFTP. The Contractor shall deliver the test results to the PM by the end of the work shift for T-99 Method A applications and within a 24 hr. period for T-99 Method D applications, based on the time the test information was collected in the field.

The Contractor's QC technician shall use the "one-point" method to establish the correct soil curve for each density test performed. If the soil does not match an established family of curves or a single curve, the Contractor shall establish a new curve for the soil, within a 48 hr. period, based on the time the sample was acquired. If use of the new maximum density curve results in a failing test, the Contractor shall take corrective action and retest until compaction is determined to meet the specifications, **prior to construction of a new lift.** *Backup samples shall be all uncontaminated portions of materials removed from beneath the gauge to perform the “one point”.*

If the equipment or material changes, the QC technician shall verify by testing that the specified densities are attained.

Verification

The QAC performs Verification tests, taken randomly, according to the Manual of Field Test Procedures Acceptance Guide (Section 4(D)).

If the soil tested, according to the “one-point” method, does not match the established curves, the Contractor shall establish a new curve from the soil at the test location and provide the test results within a 48 hr. period, based on the time the sample was acquired. Do not add new lifts until compaction is proven to meet the specified densities. The QAC shall notify the contractor and PM of the test results by the end of the work shift for T-99 Method A applications and within a 24 hr. period for T-99 Method D applications, based on the time the test information was collected in the field.

If the density test fails, the Contractor shall identify the limits of failing compaction, take corrective action, and notify the PM. The PM will schedule a new Verification test. Do not add new lifts until the Verification tests demonstrate that specified densities exist.

Independent Assurance

All parties involved in the testing process shall employ ODOT-certified technicians, use ODOT-certified labs, and use nuclear density gauge(s) meeting the requirements of ODOT TM 304.

CONCRETE

(Sections 00440, 00512, 00540, 00559, 00660, 00754, 00755, 00756, 00758 and 00921)

AGGREGATE PRODUCTION

<i>Quality Control</i>	<i>Verification</i>	<i>Independent Assurance</i>
Required	Required	Required
See Aggregate Production details, page 30.	See Aggregate Production details, page 30.	See Aggregate Production details, page 30.
Not required for commercial grade concrete	Not required for commercial grade concrete	Not required for commercial grade concrete

MIXTURE

<i>Quality Control</i>	<i>Verification</i>	<i>Independent Assurance</i>
Required	Required	Required
	Not required for commercial grade concrete	

Quality Control

The Contractor's QC technician shall perform Quality Control sampling and testing required to ensure a quality product at the frequencies indicated in Section 4(D) of the MFTP. The Contractor shall deliver the test results, of the plastic properties of the concrete, to the PM by the end of the work shift. Concrete Strength test results shall be delivered to the PM within 24 hrs. after the specified break date.

The Contractor's Quality Control (QC) plan shall identify the method used for standard curing, the type of capping system used in the strength testing of concrete cylinders and the size of cylinders to be cast.

Verification

The QAC performs Verification tests, taken randomly, according to the Manual of Field Test Procedures Acceptance Guide (Section 4(D)). Cylinders cast shall be of the same size identified in the QC plan. Strength testing shall use the same capping methods identified in the QC plan. Cylinders cast for strength verification will be delivered to the ODOTCL for further testing.

If Verification testing fails to meet the specifications, the QAC will immediately notify the PM. The PM will evaluate the results and resolve the discrepancy.

Independent Assurance

All parties involved in the testing process shall employ ODOT-certified technicians and use ODOT-certified laboratories.

The PM will perform random inspections to ensure that the contractor's Quality Control plan is followed.

The Contractor's QC technician shall test the same load and portion of load from which the Verification samples are taken. This testing will be for plastic properties and strength testing. QC technician shall immediately report the results of the plastic properties testing to the QAC. The QAC will verify that the contractor's plastic properties test results and the QAC's plastic properties test results are within IA parameters.

If the Contractor's plastic properties test results and the QAC's plastic properties test results for the Verification sample are not within IA parameters, the QAC will evaluate the results, resolve the discrepancy and notify the PM of the resolution. The QAC test results, of the plastic properties of the concrete, or the investigation of IA issues will be given to the PM by the end of the work shift, if an agency representative is available.

The Contractor's QC technician shall make and cure three (3) cylinders of the same size identified in the QC plan. Strength testing of the three concrete cylinders shall be in accordance with AASHTO T 22, using the same capping method identified in the QC plan. The PM shall compare the Contractor's results for these cylinders to the Verification cylinders and to the ongoing Quality Control. The PM shall resolve discrepancies.

On a single truck placement when Verification/IA is performed by the Region Quality Assurance Lab the contractor's test results may be used for Normal Quality Control testing.

AGGREGATE BASE, SUBBASE, AND SHOULDERS

(Section 00641)

AGGREGATE PRODUCTION

Quality Control	Verification	Independent Assurance
Required	Required	Required
See Aggregate Production details, page 30.	See Aggregate Production details, page 30.	See Aggregate Production details, page 30.

ESTABLISHING MAXIMUM DENSITIES

Quality Control	Verification	Independent Assurance
Required	Not Required	Required

Quality Control

The Contractor's QC technician is responsible for establishing maximum densities and optimum moisture content for each unique aggregate mixture type incorporated into the project. *Backup samples shall be a minimum mass of (45 lbs).*

Verification

None Required

Independent Assurance

All parties involved in the testing process shall employ ODOT-certified technicians and use ODOT-certified laboratories.

The QAC will test the Contractor's split of the aggregate sample and provide the results to the PM the next day. The PM will verify that the Contractor's test results and the QAC's test results are within IA parameters.

If the Contractor's test results and the QAC's test results are not within IA parameters, the PM will perform an investigation (see Investigation Criteria), evaluate the results and resolve the discrepancy.

AGGREGATE MIXTURE

Quality Control Required	Verification Required	Independent Assurance Required
-------------------------------------	----------------------------------	---

Quality Control

The Contractor's QC technician shall establish a random sampling and testing program and submit it to the PM prior to the start of production.

The Contractor's QC technician shall perform Quality Control sampling and testing required to ensure a quality product at the frequencies indicated in Section 4(D) of the MFTP. The Contractor shall deliver the test results to the PM by middle of the following work shift. *Backup samples shall be a minimum mass shown in Table 1 of T 255 / T 265 and kept in an airtight container.*

Verification

The QAC performs Verification tests, taken randomly, according to the Manual of Field Test Procedures Acceptance Guide (Section 4(D)).

If the moisture content exceeds the limits according to specification, the Contractor shall, take corrective action, and notify the PM. The PM will schedule a new Verification test.

Independent Assurance

All parties that test materials shall employ ODOT-certified technicians and use ODOT-certified laboratories.

If the Contractors test results and the QAC's test results for IA samples are not within IA parameters, the PM will perform an investigation (see investigation Criteria), evaluate the results and resolve the discrepancy.

COMPACTION

Quality Control Required	Verification Required	Independent Assurance Required
-------------------------------------	----------------------------------	---

Quality Control

The Contractor's QC technician shall establish a random sampling and testing program and submit it to the PM prior to the start of production.

The Contractor shall perform Quality Control sampling and testing required to ensure a quality product at the frequencies indicated in Section 4(D) of the MFTP. The Contractor shall deliver the test results to the PM on the same day the testing is performed.

The Contractor's QC technician shall also perform the following:

- Use the test procedures applicable for determination of the maximum density for this material indicated in Section 4(D) of the MFTP.
- Establish a rolling pattern to provide the specified compaction
- Stop placement if the specified densities are not met

Verification

The QAC performs Verification tests, taken randomly, according to the Manual of Field Test Procedures Acceptance Guide (Section 4(D)).

If the density test fails, the Contractor shall identify the limits of failing compaction, take corrective action, and notify the PM. The PM will schedule a new Verification test. Do not add new lifts until the Verification test demonstrates that the specified densities exist.

Independent Assurance

All parties involved in the testing process shall employ ODOT-certified technicians, use ODOT-certified laboratories, and use nuclear density gauge(s) meeting the requirements of ODOT TM 304.

EMULSIFIED ASPHALT PRODUCTS/MATERIALS

(Sections 00710, 00711, 00712, 00715 and 00730)

AGGREGATE PRODUCTION

Quality Control	Verification	Independent Assurance
Required	Required	Required
See Aggregate Production details, page 30.	See Aggregate Production details, page 30.	See Aggregate Production details, page 30.

EMULSIFIED ASPHALT CEMENT

Quality Control	Verification	Independent Assurance
Required	Not Required	Not Required

Quality Control

Sample all required materials as specified in Sections 4(C) and 4(D). Complete *ODOT Sample Data Sheet* (Form 734-4000), place in the proper containers and label as specified in Section 4(C), and deliver to the PM by the middle of the following work shift.

EMULSIFIED ASPHALT CONCRETE PAVEMENT (EAC)

(Section 00735)

AGGREGATE PRODUCTION

Quality Control	Verification	Independent Assurance
Required	Required	Required
See Aggregate Production details, page 30.	See Aggregate Production details, page 30.	See Aggregate Production details, page 30.

MIXTURE PRODUCTION

Quality Control	Verification	Independent Assurance
Required	Required	Required

Quality Control

The Contractor's QC technician shall establish a random sampling and testing program and submit it to the PM prior to the start of production.

The Contractor's QC technician shall perform Quality Control sampling and testing required to ensure a quality product at the frequencies indicated in Section 4(D) of the MFTP. The Contractor shall deliver the test results to the PM by the middle of the following work shift. *Backup samples for aggregates shall be a minimum of 1/2 the minimum mass shown in Table 1 of AASHTO R 90 for the appropriate Nominal Maximum size aggregate.*

The Contractor's QC technician is responsible for monitoring plant operation to ensure that specification materials are delivered to the project. Monitoring activities may include, but are not limited to, the following:

- Calibrate the asphalt plant
- Maintain an inventory of materials, including generated waste
- Control segregation in silo(s) and truck loading operations
- Reject any mixture that is visually defective. Inform the PM of the quantity and disposition of the rejected material
- Sample all required materials as specified in Sections 4(C) and 4(D), (e.g. liquid asphalt, emulsion, cement, tack, etc.), place in the proper container and label as specified in Section 4(C), complete *ODOT Sample Data Sheet* (Form 734-4000), and deliver to the PM by the middle of the following work shift.

Verification

The QAC performs Verification tests, taken randomly, according to the Manual of Field Test Procedures Acceptance Guide (Section 4(D)). A split of the sample taken by QC will be given to the QAC for testing.

If Verification testing fails to meet specifications, the QAC will immediately notify the PM. The PM will evaluate the results and resolve the discrepancy.

Independent Assurance

All parties that test materials shall employ ODOT-certified technicians and use ODOT-certified laboratories.

The PM will perform random inspections to ensure that the Contractor's Quality Control plan is followed.

The Contractor's QC technician shall test the Contractor's split of IA samples and provide the results to the PM the next day. The PM will verify that the Contractor's test results and the QAC's test results are within IA parameters.

If the Contractor's test results and the QAC's test results for IA samples are not within IA parameters, the PM will perform an investigation (see Investigation Criteria), evaluate the results and resolve the discrepancy.

COMPACTION

<i>Quality Control</i>	<i>Verification</i>	<i>Independent Assurance</i>
Not Required See specifications – 00735.46	Not Required	Not Required

POROUS ASPHALT CONCRETE & ASPHALT CONCRETE PAVEMENT (STATISTICAL ACCEPTANCE)

(Sections 00743 and 00745)

AGGREGATE PRODUCTION

Quality Control	Verification	Independent Assurance
Required	Required	Required
See Aggregate Production details, page 30.	See Aggregate Production details, page 30.	See Aggregate Production details, page 30.

MIXTURE PRODUCTION

Quality Control	Verification	Independent Assurance
Required	Required	Required

Quality Control

The Contractor's QC technician shall establish a random sampling and testing program and submit it to the PM prior to the start of production.

The Contractor's QC technician shall perform Quality Control sampling and testing required to ensure a quality product at the frequencies indicated in Section 4(D) of the MFTP. The Contractor shall deliver the test results to the PM by the middle of the following work shift. *Backup samples shall be a minimum mass of (45 lbs) or for Porous Asphalt Concrete (PAC), accepted under the Cold Feed Method, a backup sample of 1/2 the minimum mass shown in Table 1 of AASHTO R 90 for the appropriate Nominal Maximum size aggregate can be used.*

The Contractor's QC technician is responsible for monitoring plant operation to ensure that specification materials are delivered to the project. Monitoring activities may include, but are not limited, to the following:

- Calibrate the asphalt plant
- Maintain an inventory of materials, including generated waste
- Control segregation in silo(s) and truck loading operations
- Monitor mix temperature
- Reject any mixture that is visually defective (e.g. graybacks, overheated, contamination, slumping loads etc.) Inform the PM of the disposition and quantity of rejected material
- Sample all required materials as specified in Sections 4(C) and 4(D) (e.g. liquid asphalt, emulsion, cement, tack, etc.), place in the proper container and label as specified in Section 4(C), complete *ODOT Sample Data Sheet* (Form 734-4000), and deliver to the PM by the middle of the following work shift.

Verification

The QAC performs Verification tests, taken randomly, according to the Manual of Field Test Procedures Acceptance Guide (Section 4(D)). A split of the sample taken by QC will be given to the QAC for testing.

If Verification testing fails to meet the specifications, the QAC will immediately inform the PM. The PM will evaluate the results and resolve the discrepancy.

Independent Assurance

All parties that test materials shall employ ODOT-certified technicians and use ODOT-certified laboratories.

The PM will perform random inspections to ensure that the Contractor's Quality Control plan is followed.

The Contractor's QC technician shall test the Contractor's split of IA samples and provide the results to the PM the next day. The PM will verify that the Contractor's test results and the QAC's test results are within IA parameters.

If the Contractor's test results and the QAC's test results for IA samples are not within IA parameters, the PM will perform an investigation (see Investigation Criteria), evaluate the results and resolve the discrepancy.

COMPACTION

Quality Control	Verification	Independent Assurance
Required	Required	Required

Quality Control

Dense Graded: The Contractor's QC technician shall establish a random sampling and testing program and submit it to the PM prior to the start of production.

The Contractor's QC technician shall perform Quality Control sampling and testing required to ensure a quality product at the frequencies indicated in Section 4(D) of the MFTP. The Contractor shall deliver the test results to the PM on the same day the test is completed.

The Contractor's QC technician shall also perform the following:
(*activities listed below are not exhaustive and are considered minimums*).

- Establish a rolling pattern according to (TM-306) to provide the specified compaction
- Notify PM and CAT-II if rolling pattern is not being maintained
- Notify the PM and CAT-II if the specified densities are not achieved
- Monitor the mix temperature during laydown and compaction to keep the mix within the specifications
- Coordinate with the plant technician when changing lots
- Notify the Region QAC and PM when performing Core Correlations
- Notify the CAT-II of Control Strip Results
- Notify PM, CAT-I and CAT-II if any density results exceed 95%

Porous Asphalt Concrete: Compaction to a specified density is not required. See 00743.49 in the specifications.

Verification

Dense Graded: The QAC performs Verification tests, taken randomly, according to the Manual of Field Test Procedures Acceptance Guide (Section 4(D)).

The QAC selects random numbers for the test locations within the contractor's subplot size. If Verification testing fails to meet the specifications, the QAC will immediately notify the PM.

Failing verification requires retesting an additional verification within the next 2 shifts to confirm density specification and to isolate the original failure.

The PM will initiate an investigation. If the investigation determines there is non-specification material the PM will evaluate the test results using the Compaction Guidelines (Pg. 46) and perform resolution process as needed.

Porous Asphalt Concrete: None Required

Independent Assurance

Dense Graded: All parties involved in the testing process shall employ ODOT-certified technicians, use ODOT-certified labs and use nuclear density gauge(s) meeting the requirements of ODOT TM 304.

The Region QAC may elect to perform a gauge check as outlined in Appendix C and ODOT TM 304.

Porous Asphalt Concrete: None Required

Failing ACP Compaction Guidelines

1. QC Density Results Fail
 - a. PM will investigate and evaluate the material to determine if the material is suitable for the intended use per Section 00150.25.
 - b. PM consults the Pavements Services and Quality Assurance Unit for recommendations on:
 - Methods of investigating, evaluating, and isolating non-specification material.
 - Application of appropriate corrective action and/or price adjustment for non-specification material.
 - c. If the material is suitable for intended use the PM will apply the test results to acceptance procedures in accordance with Section 00165. Contractor should take corrective action.
2. QA Density Results Failing
 - a. PM determines the quantity of material represented by this verification. The PM should consider all material back to the last passing verification.
 - b. PM consults Pavement Services and Quality Assurance for recommendations on:
 - Methods of investigating, evaluating, and isolating non-specification material
 - Application of appropriate corrective action and/or price adjustment for non-specification material

When cores are used, laboratory testing will be conducted by the ODOT Central Materials Lab. Third Party can be initiated by the PM or Contractor.

The PM can apply a price adjustment based on values entered into STATSPEC, or can use Form 734-3946 for a small number of sublots. The PM also has the ability per section 165.50(c) to isolate material that is shown to be non-specification. Core density results or isolated non-specification material, will be evaluated as a separate lot per section 165.40 or 165.50(c).

APPENDIX A

ODOT APPROVED COMMERCIAL AGGREGATE PRODUCT PROGRAM

Commercial Aggregate Products—Aggregates not specifically manufactured and stockpiled for use on ODOT or Local Agency projects from a single source.

A supplier may submit in writing a request for commercial product(s) approval through the Region QAC. The QAE and the Region QAC will review the request and if it is a benefit to the Department, a product(s) may be put on the ODOT Approved Commercial Aggregate Product Program (OACAPP). The request shall include the following information for review:

- Production history or prior use on an ODOT project
- Location and Source Identification
- Intended use of supplied material(s)
- Quality Control Plan

The QAE will notify the Regional QAC final approval of the Quality Control Plan. The Regional QAC will notify the supplier of the approved products. The products covered by the approved Quality Control Plan are classified as ODOT Approved Commercial Products.

QAE may allow the minimum frequency to be altered after the supplier submits a written proposal to the Regional QAC. The written proposal shall detail the proposed sampling and testing frequencies and shall describe how uniformity of production will be assured.

The supplier shall retain backup samples, for the previous 10 sublots, until the test results are verified by the Region QA group or as required by the Region QAC.

The supplier shall obtain under the supervision of the Region QAC, at the minimum required frequency as shown in section 4A of the MFTP, samples for product compliance and then the Region QAC shall submit them for testing at the Central Materials Laboratory.

The supplier shall send requests to waive tests, as allowed by the FTMAG, to the Region QAC. The Regional QAC will consult with the QAE for any waivers to be granted. The Regional QAC will notify the supplier of any waivers granted. Waivers will apply to all projects which are supplied from that source.

When a waiver requires periodic testing by the supplier, the test results shall be sent to the Region QAC.

The commercial supplier shall maintain files of all QC tests for each stockpile. It shall enter the test results into the ODOT Stat. Spec. program to calculate the Quality Level for each stockpile. The QL for gradation shall meet the requirements of Section 00165 of the Oregon Standard Specifications for Construction. Other required test results shall be shown in columns to the right in the program. The Region QAC may, with approval of the QAE, accept alternate means of statistical analysis for the supplier's product. The supplier shall deliver weekly or at an interval determined by the Region QAC, copies of the ongoing subplot test results, along with the ongoing QL (Quality Levels).

The supplier shall keep the Region QAC informed about production schedules so that Verification testing can be scheduled. The Region QA group will obtain Verification samples on a random basis and the split of this Verification sample shall be ran by the supplier's QC technician to test for Independent Assurance. The test results shall be available within 24 hours of the time of sampling. If the test results indicate that the produced material meets quality requirements and the results are within IA parameters, the QAC may allow all backup QC samples prior to the Verification sample to be discarded.

The Region QAC will randomly audit the QC files to verify that the Quality Levels reflect actual test results. The Region QAC will retain QL information for each stockpile along with Verification and IA test results. When requested by the Project Manager, the Region QAC will send a memo to the PM verifying and identifying what materials were produced under the ODOT APPROVED COMMERCIAL AGGREGATE PRODUCT PROGRAM and meet the required specifications.

If Verification test results, for tests other than gradation, do not meet the quality requirements, no material from the stockpile in question will be accepted until the problem has been resolved. The Region QAC will notify each PM, for the projects being supplied from that source, that the material in question shall not be used until the problem has been satisfactorily resolved. The resolution may involve rejection of the stockpile if the investigation confirms non-specification material. If the material test results do not meet IA parameters, the Region QAC will work with the supplier to resolve the problem.

The Region QAC will provide data to other Regions that are using material considered ODOT Approved Commercial Products.

The Region QAC may discontinue a supplier's Commercial Product status for those product(s) effected based upon (but not limited too):

- The supplier is not following their Quality Control Plan
- Product(s) fail to meet a compliance testing requirement
- It is determined that an aggregate product(s) is no longer a benefit to the Agency

The Commercial Product status may be returned upon approval of the QAE and Region QAC.

APPENDIX B

CONTRACTOR QUALITY CONTROL PLAN

This plan is intended to provide a description of the personnel involved in the testing activities and identify the system or process for material Quality Control. The Quality Control Plan must contain at a minimum the following information.

- Include: Project Name, Contract Number and date of anticipated use and author of submitted plan.
- Provide office telephone, cellular phone & fax numbers for contractor's superintendent & quality control manager.
- Describe personnel & methods to deliver accurate, legible & complete test results to designated agency representative, within required time limits.
- Designate who will provide required QL analysis.
- Describe location and methods for backup sample storage.
- Provide random numbers and include examples of your method for applying, to provide representative samples.
- Provide Technician and Lab Certifications for all equipment, laboratories, & technicians used to perform testing on and offsite for the project.
- Provide current Scale License and Certification for all weighting devices used on the project. Identify the location of the scales and type of scale e.g. platform, silo etc.
- For every material that has tolerances or limits for tests listed in the Manual of Field Test Procedures, provide:
 - Bid item & Specification Section number(s) for product to be used.
 - Source and supplier of material
 - Proposed production rate, methods & source of testing
 - Anticipated earliest date of use
- For each material supplier & subcontractor, provide:
 - Company name, address, & physical location.
 - Quality control contact name and telephone #.
 - Location, type, & quantity of materials to be used.

APPENDIX C

TROUBLESHOOTING GUIDE

The following information is a guide to assist in the evaluation of discrepancies that commonly occur between Independent Assurance test results and Verification test results. This information is only a guide and is not necessarily a comprehensive list of all potential areas to be investigated. A best practice is to consult the Region QAC for help early in the troubleshooting process.

General

1. Check if the technician signing the report is the person performing the tests.
2. Check that the technician performing the testing is certified.
3. Check that the lab and equipment used are ODOT certified.
4. Check that the proper procedures and methods were performed.
5. Check all mathematics.
6. Check Balances for accuracies and functionality.
7. Check constant mass calculations if available, comparing moistures can also indicate incomplete drying of sample.
8. Contact Region QAC, their involvement can significantly reduce time spent troubleshooting and getting to resolution.

AGGREGATE TESTING

Gradation

1. Check sample size meets minimum requirements.
2. Inspect sieves for deformed wires or torn fabric.
3. Compare both test results for sample initial wet weights, initial dry weights, after wash dry weights, individual sieve weights and any tare weights if used. May point to a transposed or incorrectly recorded weight. May point to a splitting error.
4. Check sieve loss calculations.
5. Are their screens overloaded?
6. Check to see if the hand sieving procedure shows equipment operating correctly.
7. Check wash loss. May point to error in initial dry weight.
8. Have QC run QA split and observe. This action might indicate equipment, procedural discrepancies and /or splitting issues.
9. Compare results to ongoing Stat spec mean values.

WOODWASTE TEST

1. Is the drying method burning up wood?
2. Check equipment used for the procedure for correct size and state of repair.

FRACTURE TEST

1. Did both parties test the same? (Splitting the sample or not splitting the sample.)
2. If samples not split, do F+Q+N match closely to the retained mass(s) for gradation?
3. Do both parties have approximately the same amounts of F, Q, and N? If not may indicate a difference in interpretation of fractured particles.
4. Have QC run QA split and observe. This action might reveal procedural discrepancies and if results do not vary from originals, may indicate difference introduced during splitting.

FLAT AND ELONGATED TEST

1. Did both parties test the same? (Based on individual screens during gradation analysis and summed up or material recombined and split out with one evaluation)
2. Does MS closely match the retained masses for gradation (+ No. 4 material)
3. Proper caliper ratio used by both parties?
4. Have QC run QA split and observe. May indicate differences introduced during splitting.
5. Check caliper for tight fit between points when closed and smooth operation of armature.

SAND EQUIVALENT TEST

1. Compare Sand reading, if significant differences present this is an indication a under sized T_{in} or insufficient compacting effort when filling T_{in} .
2. Did both parties test at the same moisture content?
3. Are the methods of shaking suspending all fines?
4. Check lab temperatures and SE stock solution's age and the SE working solution's age and temperature. When in doubt observe technician prepare new batch of working solution.
5. Have QC run QA split of sample and observe procedures.
 - a. Look for vibration in surface where SE's tubes are set.
 - b. Were all the fines put into suspension?
 - c. Check shaking device for proper throw distance and proper number of strokes.
 - d. Check irrigation wand to insure good fluid flow from both openings.
 - e. Digital timer being used.
 - f. Weighted foot assembly in good condition and properly lowered.
 - g. Graduated marks properly read
6. Observe parties cleaning the +4.75mm (No. 4) material insuring fine particles are removed.
7. If results do not vary from originals, may point to a splitting issue.

SOIL/AGGREGATE RELATIVE MAXIMUM DENSITY AND OPTIMUM MOISTURE

1. Was the sample initially oven-dried (not allowed)? Separate samples at each point or re-compacted? Samples tested immediately or "marinated" moistures overnight?
2. Check plotting of data. Correct scale used. Dry densities plotted vs. dry basis moistures.
3. Check tare weights on molds/base plates. Collar removed?
4. Check mold volumes according to T 19; is there a significant difference from the standard volume?

5. Check surface on which samples were compacted. Is it unyielding surface?
6. Check constant mass on individual samples if available.
7. If available, check planning sheets for correct moisture addition calculations.
8. When held up to a light (or placed on a light table) do the two curve shapes match closely? Same shape, but one curve plots higher and to the left, indicates different compaction energy consistently applied to samples.
9. Was the passing No.4 or 3/4" material brushed off the retained No.4 or 3/4" material?
10. Have QC run a point at optimum moisture from their curve on the passing No.4 or 3/4" observe them perform the sample preparation and compaction procedure. Correct moisture computed and material properly mixed? Correct layers and layer heights? Hammer dropped from the correct height? Correct number of blows? Correct trimming and cleaning of mold? Moisture samples obtained correctly tested?

COARSE AGGREGATE BULK SPECIFIC GRAVITY TEST

1. Check thermometers.
2. How do values compare with pit history?
3. Were samples oven dried prior to soaking?
4. Do both parties have approximately the same G_{sa}? This indicates the difference is probably in interpretation of the SSD point. If these results are very different this points to weight in water error, so was empty basket weighed in water or "zeroed" in water?
5. Screen over a nested 1/4" and No. 4 sieve. Significant material passing the No. 4 indicates an error in screening of material.
6. Have QC run QA sample and observe the sample preparation procedure.

COMPACTION OF SOILS & PROCESSED AGGREGATE

There are no IA parameters for compaction. If verification for compaction fails see the Specification specific section for how the QC is to resolve the failing area.

1. Is the correct curve being used? Is the correct density information being used?
2. Coarse Particles fit the rules for Method A or Method D? Fits curve used?
3. Observe testing in the field and look for the following: Random Representative location selected. Correct site preparation, drilling of the test hole, placement and seating of the gauge, data recorded.
4. For Soils. Observe proper fabrication of the one point and look for the following: Proper screening of material, in-place moisture measured prior to addition of additional moisture if needed, proper compaction of sample in correct mold, stable surface for compaction of one point?
5. Check Speedy moisture tester, balances and has density gauge been calibrated and calibration been verified by Region QA lab.

ACP TESTING

The following should be considered in addition to the items listed in the Aggregate section.

IGNITION OVEN – AC CONTENT

1. Was the correct calibration factor used?
2. Were calibration samples batched properly and calculations performed correctly?
3. Was companion moisture used or sample dried prior to testing?
4. Sample has a clean burn? Sample achieved constant mass?
5. Check basket weights. Check sample size.
6. Check gradation results. The coarse half of a split may have lower asphalt content than the fine half.
7. Is the Oven set at the correct temperature?
8. Does the manufacture scale drift test meet parameters?
9. Was the thermometer removed prior to Initial and Final Weighing?
10. Were the initial and final weights taken at the same temperatures?
11. Was the mix moisture removed from the initial mass reading?

RICE GRAVITY TESTING

1. Check tare weights of pycnometers and lids.
2. Check sample sizes.
3. Check pycnometers calibration numbers.
4. Check equipment. Proper vacuum pressure? Calibrated thermometer?
5. Is the “dry back” procedure appropriate for this material?
6. Check gradation results. The coarse half of a split will have a higher Rice Gravity than the fine half.

BULK GRAVITY TESTING

1. Check sample heights.
2. Check measured volumes compared to heights. Tallest specimen should have largest volume.
3. Check equipment. Suspension apparatus hanging free? Calibrated thermometers? Tank overflow? Damp towel for SSD?
4. Check compaction equipment. Proper gyrations, pressure, angle of gyration, compaction temp?
5. Observe testing. Swap samples and observe performing procedure. Watch immersion and SSD procedures. Is basket and wire assembly free floating?
6. If results do not vary from originals, may point to a splitting or compaction error.
7. If results vary from originals, may point to a technician or equipment error.

ACP DENSITY TESTING

There is not opportunity to rework ACP; therefore, it is imperative to troubleshoot density testing issues immediately.

QC Best Practice

Once the gauge has been initially ODOT calibrated, identify a location that can act as a reference, this site should be an area of flat concrete. Set the gauge on the flat concrete surface and scribe a line around the case. Take a four-minute test on the site and document the result. It is a good idea to paint the density on the concrete so that others may use it too. Test the gauge at this site prior to going to the project to assure that the gauge is still reading consistently. Performing Standard Counts on project site before starting daily work is required and running another set at mid shift helps to maintain consistent readings.

Project Manager

1. Has the Contractor's gauge calibrated or verified by the Region QA group? Ask to see Cert.
2. Correct MAMD used? Core Correlation factor applied if needed?
3. Check the following correct; site preparation, placement and seating of the gauge, footprint marked, data recorded, rotation gauge.
4. Does the first subplot MDT match the JMF MDT within reasonable parameters? Specification is 50 kg/m^3 (3.0 lb/ft^3) this is really a large variation - check the asphalt content of the mixture.
5. If compaction is low, are there sufficient rollers of proper weight (according to specifications), to achieve compaction? Does compaction correlate with Voids i.e. high voids low compaction?
6. Is the mix tender? Seek help from QAC or ODOT Pavements.
7. Is rolling compacting the whole panel, not just the center? Consistent with Control Strip?
8. Is the lay down temperature correct according to the JMF or has temperature changed during production? Has there been a substantial change in lift thickness?
9. Is weather a factor (colder, wetter, or windy)?
10. Is the existing surface being paved on in question? I.e. paving over open graded ACP, PCC surfaces or extremely distressed existing pavement.
11. Does Coring need to be performed to validate in-place compaction? Call the pavements unit for guidance.

If any problems are found that cannot be resolved, the inspector or QCCS should contact the Region QA group immediately.

QA

QA is to verify compaction using separate, randomly selected sites. There is no direct comparison Independent Assurance parameter for nuclear density testing.

1. Periodically during the construction, perform counts on the Region calibration blocks in the backscatter position.
2. On the project, choose one or two sites at random and perform the normal tests on these sites with both the QC and QA gauges. The average for each gauge when compared to the other should be within 2 lb/ft³.
3. If the difference between the two gauges is greater than 2 lb/ft³, the Contractor's QC technician should rerun the tests while the QAT observes.
4. If the two gauges are not in agreement, re-standardize both gauges and re-shoot the location two shots in the same direction. If the gauges still do not compare take both gauges back to the calibration blocks and check their calibration and follow TM 304.
5. If either gauge is out of calibration, recalibrate prior to project testing.
6. If the gauges are in calibration. Core Correlation should be performed to remove gauge differences.
7. The Project Manager and Region QAC should work together to resolve QC sublots brought into question by Verification results.

Plastic Concrete Testing

General For All Concrete Tests

1. Was the test started within prescribed time limits of obtaining the sample?
2. Were the QA and QC samples taken from the same portion of the load?
3. Was the sample adequately recombined if taken from two parts of the load?
4. Was the concrete covered if ambient conditions were adverse?
5. Was all equipment used within specification/tolerance, clean and damp prior to test?
6. Was excess water removed from the sampling container prior to obtaining the sample?

Slump (T-119)

1. Once the test was started was it completed in the allotted 2 ½ minutes and immediately measured?
2. Does Equipment meet specification?
3. Tamping rod w/hemispherical tip
4. Flat, rigid, non-absorbent base, level and on a surface free of vibration or disturbance (not a warped water damaged piece of plywood)
5. Cone that is free of dents, rust damage and concrete build up on the inside
6. Correct amount of layers and quantity/volume in each layer?
7. Was each layer rodded 25 times extending into the preceding layer?
8. On the top layer, was a head kept above the top of the cone at all times?
9. Was the excess concrete cleaned away from the base of the cone prior to lifting?
10. Was the cone pulled too fast/slow?
11. Was the cone pulled straight with no twisting or lateral movement?
12. Was the measurement reading taken from the displaced original center?

Note: If mix has retained 1 ½ inch or larger aggregate, it must be removed by the wet sieve method prior to performing the test.

Air Content (AASHTO T-152)

1. Was the test started within 5 minutes of obtaining the sample?
2. Has the air meter gauge been calibrated within the last three months?

NOTE: The air meter calibration can be checked in the field.

3. Was the bowl filled in approximately equal 1/3 layers?
4. Was each layer rodded 25 times extending into the preceding layer?
5. Were the sides of the bowl tapped 10 to 15 times with a mallet after each layer had been rodded?
6. Was the cover seal moistened and seated properly on the bowl?
7. Was water injected into the petcocks and meter rocked until no air bubbles appeared?

8. Was air pumped into the initial air chamber until it passed the initial pressure setting (as determined in the calibration process) and allowed to cool? Was any air noted seeping out of open petcocks at this time?
9. Was initial gauge adjusted to initial air pressure before opening main air valve?
10. Were the sides of the bowl tapped “smartly” during release of main air valve?
11. During release of main air valve was there any air leaking out the sides due to an incomplete seal?

Temperature (AASHTO T-309)

1. Has the measuring device been calibrated or verified for accuracy within the last year?
2. Was there adequate concrete cover around the measuring device sensor (at least 3”)?
3. Was the concrete pressed around the measuring device at the surface?
4. Was the temperature recorded after a minimum of 2 minutes and the measuring device allowed to stabilize?

Unit Weight (AASHTO T-121)

Since the unit weight test is usually performed in conjunction with the air content test, see steps 3, 4 and 5 under the air content portion of this guide.

1. Check math
2. Was the dry mass of the measure accurately recorded?
3. Has the measure’s volume been accurately calibrated?
4. Was a strike off plate used to create a smooth surface free of voids and level with the rim?
5. Is the scale accurate? Cross check QA and QC scales to field verify accurate measurement.

INSERT TAB

SECTION 3
Report Forms & Examples

SAMPLE AND TEST REPORT FORMS

This Section includes a sample of each of the ODOT forms used for submitting samples and reporting test results. The forms can accommodate two different formats, Metric and English. At the top of the form is an area that allows the user to switch between the different units. Examples of completed reports, in English are also included. Located after the table of contents section is a forms description document that outlines the functions and calculation abilities, if applicable, of the various forms. Each form has a unique number identifier that starts with 734-xxxx and the forms are arranged in numerical order, 734-1792, 734-1793A etc.

If a certified technician elects to use forms other than ODOT, then the modified form must contain the same information and be presented in a similar format to the existing ODOT form. The technician must obtain the approval of the Project Manager prior to using different forms. When submitting material for testing to the Salem Materials Laboratory, the appropriate ODOT form must be utilized.

These forms are available electronically. They may be downloaded from our webpage in FTP format.

The URL address is:

<https://www.oregon.gov/odot/Construction/Pages/Forms.aspx>

Submittals of form 734-4000, 734-4000C or 734-4000 NFTM requires properly completing the required information as outlined in Section 4 (C) of the MFTP. **If the information required in Section 4(C) is not included on the submitted forms the material will not be accepted for testing.**

A unique data sheet number is also required on the form that is referenced to a submitted sample in chronological order. The data sheet number is a unique value assigned by the submitting party. Example: F-40123-001, the F is generic on all form 4000's, the next set of numbers, in this example, is the technician's certification number and the last series of values indicates the sequential order of submitted samples, 001, 002, 003, etc. If a technician certification number is not available contact the Salem Materials Laboratory at (503-986-6626) and a unique number will be assigned to the user. This eliminates duplicate data sheet numbers, maintains the integrity of the data base and provides for efficient retrieval of information.

The Contractor shall submit copies of the test results to the specified ODOT personnel within the timeframes set forth in the QA program and the project contract. Either the copy of the results or a facsimile of the results will be accepted. The Contractor shall retain the original results for at least three years after ODOT formally accepts the project.

**Oregon Department of Transportation
Field Tested Materials Forms and Examples**

Soils	
<i>ODOT Form Number</i>	<i>Description</i>
734-1793 S	Nuclear Compaction Report For Soil
734-3468	Maximum Density of Construction Materials
734-3468 FC	Family of Curves
Aggregate	
<i>ODOT Form Number</i>	<i>Description</i>
734-1792	Field Worksheet for Aggregate
734-1793 B	Nuclear Compaction Report For Base Aggregate
734-1825	Unit Weight and Specific Gravity W/S
734-1825 C	Bulk Density "Unit Weight" Measure Calibration
734-3468 B	Maximum Density of Aggregate Base Material
Asphalt Concrete Pavement (ACP)	
<i>ODOT Form Number</i>	<i>Description</i>
734-1793 A	Nuclear Compaction Report For ACP
734-1793 AR	Nuclear Compaction Report For ACP with Random Location
734-1793 A10	Nuclear Compaction Report For ACP, 10 shot locations
734-1972 A	Random Sample Locations for Density Testing of ACP
734-2043	Daily Asphalt Cement Report
734-2050	Specific Gravity and Maximum Density of ACP
734-2050 GV	Voids Worksheet Gyratory - Multiple
734-2050 GVS	Voids Worksheet Gyratory - Single
734-2050 TSR	Tensile Stripping Strength (TSR) Worksheet
734-2084	Control Strip Method of Compaction Testing
734-2084 T	Establishing Roller Pattern for Thin Lifts of ACP
734-2277	Field Worksheet for ACP (Plant Report)
734-2327	Nuclear-- Core Correlation Worksheet
734-2327 CB	Calibration Batch Form
734-2327 IC	ACP Incinerator Oven Calibration Worksheet

Asphalt Concrete Pavement (ACP)	
<i>ODOT Form Number</i>	<i>Description</i>
734-2401	Daily Asphalt Plant Production
734-2401 ACP	Daily Asphalt Plant Reconciliation ACP
734-5068	CAT II – MDV Startup Review
734-2560	CAT II – JMF Target Adjustment Summary
734-5069	CAT II – Density / Control Strip Reconciliation
Concrete	
<i>ODOT Form Number</i>	<i>Description</i>
734-3573 WS	Concrete Yield and WIC Ratio Worksheet
734-4000 C	Sample Data Sheet for Concrete Cylinders
Pavement Marking Retroreflectivity Testing	
<i>ODOT Form Number</i>	<i>Description</i>
734-4101	Pavement Marking Retroreflectivity Testing – General
734-4102	Pavement Marking Retroreflectivity Testing – Longitudinal Markings
734-4103	Pavement Marking Retroreflectivity Testing – Transverse Markings
734-4104	Pavement Marking Additional Testing Required - Longitudinal Lines
734-4105	Pavement Marking Additional Testing Required - Transverse Markings
Miscellaneous	
<i>ODOT Form Number</i>	<i>Description</i>
734-1972	Random Sample Locations by Station Random Units Table
734-4000	Sample Data Sheet
734-4000 NFTM	Sample Data Sheet for Non-Field Tested Materials
734-4040	QA/QC Testing Investigation
734-5072	Random Number Table
734-5189	Resin Bonded Anchor Pull Test
734-5292	Mechanical Anchor Pull Test

Note: These forms may be photocopied for your use. They are also available in Microsoft Excel file format on the Construction Section webpage at the following address:

<https://www.oregon.gov/odot/Construction/Pages/Forms.aspx>

To copy or move sheets within or between workbooks use the following procedure:

- Save desired forms from the address above and open all files intended for the workbook.
- Right click the work sheet tab to be moved or copied.
- From the pop-up window, left click "**M**ove or Copy..."
- From the pop-up window, left click drop down button from the "**T**o Book:" box.
- Select desired workbook or (new book).
- Select location in workbook to copy or move sheet in the "**B**efore sheet" box.
- To keep a copy in the original book and move select "**C**reate copy", otherwise leave blank.
- Click **OK**.

Description of Worksheet & Calculation Explanations

General Instructions

All forms, with the exception of the **1972 A**, **2327 IC**, **2401**, **2550**, **4000**, **4000 NFTM** and **4040** forms, have an English (**E**) or Metric (**M**) toggle box in the upper right corner of the form. The default setting will show English units. For field use the forms may be printed in dual units by leaving the box blank, entering (**E**) for English units, or entering (**M**) Metric units. Computer generated forms must have either an (**E**) or (**M**) entered in the box. The forms will then convert to English or Metric and calculate accordingly.

Some forms have color shaded data entry cells. This is to give a visual check for the user to see if data may be missing on the form. These cells are auto-formatted and the shading will disappear when data is entered. If the cell is intentionally left blank or a zero value is in the cell the shading will be visible. If no shading is desired for printing the user can go to: file > page setup, select the sheet tab and check the print black and white box.

1792 FIELD WORKSHEET FOR AGGREGATES

Enter either (**E**) for English or (**M**) for Metric. Enter sieve weights from the PAN cell up for washed gradations and from the top down for dry gradations. This will allow .075mm (#200) specifications to be taken to one decimal place. For dry gradations enter the dry mass and pan in the after wash dry mass and pan cell for the sieve loss to calculate. Enter the specification for either Method 1 (Combined) or Method 2 (Individual) for Fracture to calculate. Manually enter Cumulative % Retained (100-% Passing) for Fineness Modulus to calculate. Enter dry mass of wood waste.

1793 A NUCLEAR COMPACTION TEST REPORT FOR ACP

Enter either (**E**) for English or (**M**) for Metric. Enter correlation factor from **Form 2327** in the core to nuclear correlation box if applicable, otherwise leave blank. Form will calculate percent compaction for each test and the average of the five tests.

1793 AR NUCLEAR COMPACTION TEST REPORT FOR ACP with RANDOM'S

This form is the same as 1793 A except that it also has a section to calculate random testing locations and offsets. This form is an option for use in-lieu of the standard 1793 A form. The same directions apply as form 1793 A. For the yield calculation enter the MAMD, % compaction, panel depth and width, and subplot size. The random's can be set to auto-calculate, by entering an "X" in the auto-calc random's box, or manually by leaving blank. Enter an "X" in the checkbox to base random's on distance or tons. Enter an "X" in the appropriate box to calculate random's in ascending or descending order.

(See Next Sheet for Lane Configuration Examples and test site association)

Description of Worksheet & Calculation Explanations

Form 1793 A & Form 1793 AR – (Example of Lane Designations and Test Site Location)

When a set of density tests are taken for a subplot, circle the appropriate direction and lane in which the test was taken. If testing is comprised of multiple lanes and/or ramps, note the test number and location in the remarks. Examples of lane designations are as follows:

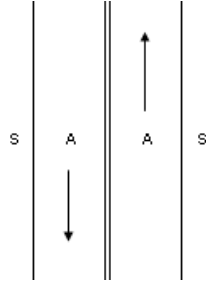

One Lane per Direction

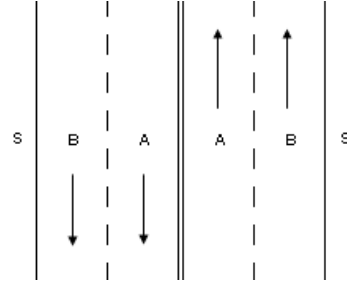

Two Lanes per Direction

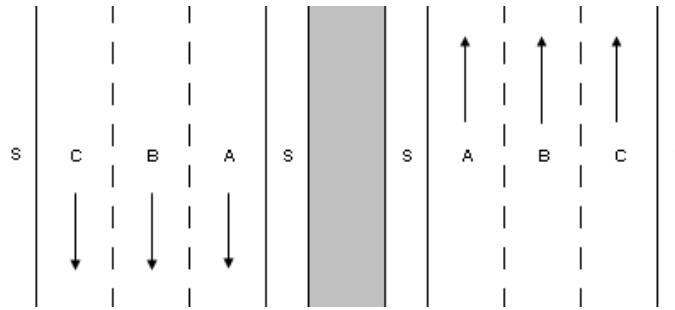

Three Lanes per Direction

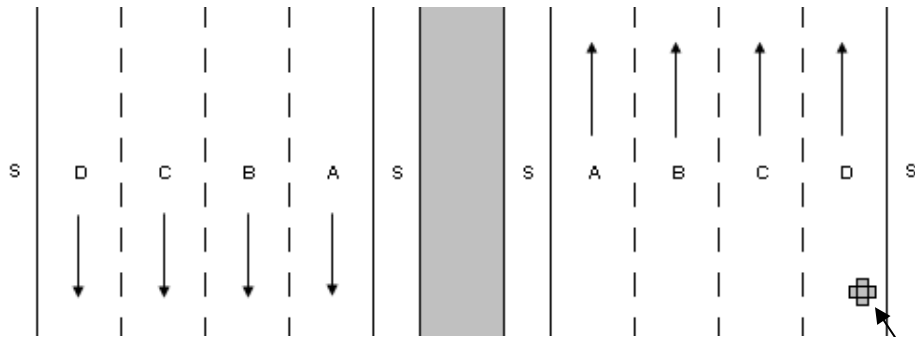

Four Lanes per Direction

TEST LOCATION

Example: Shoulder and D lane pulled in the same panel (test location shown above)

REPRESENTS MATERIAL INCORPORATED			
FROM STATION	<input type="text"/>	TO STATION	<input type="text"/>
FROM OFFSET	<input type="text"/>	TO OFFSET	<input type="text"/>
CIRCLE DIRECTION	NB SB EB WB	CIRCLE LANE	S A B C D S

Description of Worksheet & Calculation Explanations

- 1793 B** NUCLEAR COMPACTION TEST REPORT FOR BASE
Enter either **(E)** for English or **(M)** for Metric. Enter shot data for wet densities and moistures. Form will average shots and compute dry density, percent moisture, and percent compaction for each individual test.
- 1793 S** NUCLEAR COMPACTION TEST REPORT FOR SOIL
Enter either **(E)** for English or **(M)** for Metric. This form will auto-calculate. If an unscreened sample is used to verify gauge moisture enter the sample information in the appropriate boxes in the one-point section. If not the first one-point will be used to verify gauge moisture. Enter the appropriate mold factor. Enter the % Coarse (Pc) in the box from the Method "A" or "D" screening process. Enter curve data. The section of the form will auto-calculate.
- 1825 C** BULK DENSITY "UNIT WEIGHT" MEASURE CALIBRATION
Enter either **(E)** for English or **(M)** for Metric. Enter mass (lbs for English or kg for Metric) in boxes "1" and "2". Box "A" will auto calculate. Enter Temperature of water (°F for English or °C for Metric) and corresponding density in box "B" from water density table. Box "V" volume will auto calculate.
- 1825** UNIT WEIGHT AND SPECIFIC GRAVITY W/S
Enter either **(E)** for English or **(M)** for Metric. AASHTO T 19: Enter masses (lbs for English or kg for Metric) in boxes "A" and "B". Box "C" will auto calculate. Enter volume of measure (ft³ for English or m³ for Metric) from form 1825 C in box "D". Unit Weight will auto calculate. AASHTO T 85 and 84: Enter mass (grams) in boxes "A", "B", and "C". Specific gravity values and absorption will auto calculate.
- 1972** RANDOM SAMPLE LOCATIONS
Enter either **(E)** for English or **(M)** for Metric. This is not a calculating form.
- 1972 A** RANDOM SAMPLE LOCATIONS FOR DENSITY TESTING OF ACP
The user can utilize either tonnage values or distance values for determining random sample locations. In most cases using tonnage values may simplify random sampling management. For the yield calculation enter the MAMD, % compaction, panel depth and width, and subplot size. The random's can be set to auto-calculate, by entering an "X" in the auto-calc random's box, or manually by leaving blank. Enter an "X" in the checkbox to base random's on distance or tons. Enter an "X" in the appropriate box to calculate random's in ascending or descending order.
- 2043** DAILY ASPHALT CEMENT REPORT
Enter either **(E)** for English or **(M)** for Metric. Some portions of this form are automatically calculated. Volumes in Tank and Temperature Corrections Factors need to be hand entered. The quantities will need to be carried forward to the next report in order to maintain a running total.
- 2050** SPECIFIC GRAVITY AND MAXIMUM DENSITY OF ACP
Enter either **(E)** for English or **(M)** for Metric. This form is designed for daily, first sample calculation of MAMD for compaction. The MAMD will not calculate but the MDT will self- calculate.
- 2050 GV** VOIDS WORKSHEET GYRATORY
Enter either **(E)** for English or **(M)** for Metric. Enter Design Gsb and Asphalt Gb, test result P#200, test Pb, select dryback requirement according to AASHTO T209 yellow sheet requirements, and Specimen Height for each test sample. Enter previous form results for running average calculation.
- 2050 GVS** VOIDS WORKSHEET GYRATORY
Enter either **(E)** for English or **(M)** for Metric. Enter design Gsb and Asphalt Gb, select dryback requirement according to AASHTO T209 yellow sheet requirements, test P#200, and test Pb in center of form. Enter previous form results and current test results at bottom for running average calculation.
- 2050 TSR** TENSILE STRIPPING STRENGTH
Enter either **(E)** for English or **(M)** for Metric. In test condition cell enter Wet for saturated specimens and leave blank for dry specimens.

Description of Worksheet & Calculation Explanations

- 2084** **CONTROL STRIP METHOD OF COMPACTION TESTING**
Enter either (**E**) for English or (**M**) for Metric. This is not a calculating form.
- 2084T** **CONTROL STRIP METHOD OF COMPACTION FOR THIN LIFTS OF ACP (TM 301)**
Enter either (**E**) for English or (**M**) for Metric. This is not a calculating form.
Enter the station and offsets of the two Evaluation points.
- 2277** **FIELD WORKSHEET FOR ACP (PLANT REPORT)**
Enter either (**E**) for English or (**M**) for Metric. Enter the exact term, **EAC** or **ACP** in the heading cell. Enter Sieves from the pan up. When applying correction factors for aggregate gradation and/or asphalt (**Cf**) from Form **2327 IC**, they should be entered as they appear on that form (e.g. + or -). Enter dry washed mass with pan tare for sieve loss calculation. The total asphalt (**O**) cell is the sub total multiplied by the asphalt meter correction cell, if needed. If the plant reads in Tons leave the asphalt meter correction blank. If Ultrapave is used, convert to dry Tons/Mg and enter those values for beginning and ending antistrip.
- 2327** **NUCLEAR - CORE CORRELATION WORKSHEET**
Enter either (**E**) for English or (**M**) for Metric. This form calculates the information to the ratio used cells. Check the unwanted ratios and the form will automatically adjust the overall correlation.
- 2327 CB** **CALIBRATION BATCH FORM**
Enter either (**E**) for English or (**M**) for Metric. Hand enter all information in heading block, JMF % Pass and RAP % Pass columns, all weights in Actual column, and Buttered Mixing Bowl & Spoon cell. All other cells will automatically calculate.
- 2327 IC** **ACPINCINERATOR OVEN CALIBRATION WORKSHEET**
If the blank and RAP are combined prior to washing, enter the combined weights in the center of the form for wet, dry, and after washed dry masses. If performed separately, use the RAP sample section in the upper right portion of the form and use the center portion for the Blank only.
- 2401** **DAILY ASPHALT PLANT PRODUCTION**
Enter the exact term **EAC** or **ACP** in the material type cell. The form assumes that Antistrip is incorporated before the aggregate inclined belt scale therefore including the mass of Antistrip in the total dry aggregate for proper calculations. If Antistrip is added after the aggregate inclined belt scale the mass of Antistrip will not be included in the total dry aggregate and will erroneously affect subsequent calculations. Contact the Region QAC for assistance on how to properly account for Antistrip for plants setup in this fashion. The asphalt deductions box (**k**) is only for material removed from the oil tank during production and not incorporated into the mix (material removed and used for other purposes). It is not to be used to deduct asphalt in mix waste based on the 2043 form. For plants that meter RAS and RAP as a combined product the meter readings should be entered in the "RAP/RAM" block of the meter readings section. For plants that meter RAS and RAP separately the individual RAS and RAP meter reading should be entered in their respective locations. For Asphalt and Antistrip meter readings supplied in tons enter 1.0 in the correction box cell. If a multiplier is necessary to convert meter readings to Tons enter the appropriate value in the correction box cell.
- 2550** **CAT II – MDV STARTUP REVIEW**
Enter MDV test data and evaluate according to Section 00745.16(b)(c)1-6. Check appropriate box (1-6) to identify step of MDV Startup Process review represents. This is a not a calculating form.

Description of Worksheet & Calculation Explanations

- 2560** **CAT II – JMF TARGET ADJUSTMENT SUMMARY**
Enter either (E) for English or (M) for Metric. Enter JMF adjustments made in column under “ADJUSTMENT #” box. Detail justification and obtain Engineers approval as required for each adjustment made. Enter in the “sublot” box, the sublot number for which the adjustment becomes effective.
- 2584** **CAT II – DENSITY / CONTROL STRIP RECONCILIATION**
Enter either (E) for English or (M) for Metric. Enter data supplied from CAT-I and CDT in the appropriate boxes for “Quality Control Lab Results” and “Control Strip Results”. Identify if results reconcile by checking “YES” or “NO” box. Detail any corrective action taken or method of resolution as appropriate.
- 3468** **MAXIMUM DENSITY OF CONSTRUCTION MATERIALS**
Enter either (E) for English or (M) for Metric. This form has a Material Description box in the heading area to give a visual description (dark brown, gravelly clay). The companion form will compute the coarse particle corrections based on the rules established under T 99/180. The mold factor must be manually entered in the “Mold Standardization Block”. This value is determined on each mold used and is calibrated annually per AASHTO T-19M/T.
- 3468 B** **MAXIMUM DENSITY OF AGGREGATE BASE MATERIALS**
Enter either (E) for English or (M) for Metric. This form is intended for use in conjunction with AASHTO T 99 “Method A” as required for test method ODOT TM 223. Enter the statspec stockpile mean for the material **retained** (100 - % passing) on the #4 (4.75mm) sieve in the “Pc” box. The scales for density and moisture on the graph auto calculate however the formulas are not protected. If either scale does not fit the data from the points, they can be manually overwritten. Enter the mass for “mold and materials” and “mold” in grams. The “mass of mold” entered for point #1 will auto insert for subsequent points.
- 3468 FC** **FAMILY OF CURVES**
Enter either (E) for English or (M) for Metric. This is not a calculating form.
- 3573ws** **CONCRETE YIELD AND W/C RATIO WORKSHEET**
Enter either (E) for English or (M) for Metric. The pot calibration is a divisor number, not a multiplier. The number for ¼ cubic foot pots should resemble 0.2497 for English and 0.007070 for Metric.
- 4000** **SAMPLE DATA SHEET**
In the Data Sheet Number cell the “F” number is the card number and one plus number of data sheets submitted prior to it. Also remember to include your Phone Number.
- 4000 C** **SAMPLE DATA SHEET FOR CONCRETE CYLINDERS**
Enter either (E) for English or (M) for Metric. This form does the same calculations the **3573wc** form. The NET WEIGHT is the weight of the concrete only and does not include the weight of the pot. In the slots with the capitol letters “A through H” there should be a number to represent the number of days for the break. The “F” number is the card number and one plus number of data sheets submitted prior to it. Also remember to include your Phone Number.
- 4000NFTM** **SAMPLE DATA SHEET FOR NON-FIELD TESTED MATERIALS**
This form is for submittals of materials not field tested and includes items like steel, bolts, washers etc.
- 4040** **QA/QC TESTING INVESTIGATION**
This form is for data collection during the investigation phase outlined in the Quality Assurance Program under Appendix C. Remember to submit copies of the report according to the distribution list.

Description of Worksheet & Calculation Explanations

4101-4105 PAVEMENT MARKINGS RETROREFLECTIVITY TESTING

These forms are used to document the Retroreflectivity of Longitudinal and Transverse pavement markings for durable and high performance applications. The forms also include areas for bead embedment estimates. Follow the test procedure for the proper completion of these forms.

FIELD WORKSHEET FOR AGGREGATE

E English (E) or Metric (M)

PROJECT NAME (SECTION) US97: Lower Bridge Rd (Terrebonne)				CONTRACT NUMBER C15123	
CONTRACTOR OR SUPPLIER Hooker Creek			PROJECT MANAGER Earl Mershon		BID ITEM NUMBER 420
SOURCE NAME Red Rock Quarry			SOURCE NUMBER 04-32-01		MATERIAL SIZE #4 -#8
TEST NO. IA-4	DATE 4/27/2015	TIME 10am	SAMPLED AT Belt		TO BE USED IN ACP

SIEVE SIZE	SPECS. LIMITS	SIEVE ANALYSIS AASHTO T27/11							FM CUMULATIVE % RETAINED
		MASS 1	MASS 2	MASS 3	MASS 4	TOTAL MASS	% RET	% PASS	
						0.0	0.0	100	
						0.0	0.0	100	
1"		0.0	0.0			0.0	0.0	100	
3/4"	99-100	0.0	0.0			0.0	0.0	100	
1/2"	85-95	338.0	105.2			443.2	12.1	88	
3/8"	39-55	1115.2	396.4			1511.6	41.4	47	
1/4"		911.7	553.9			1465.6	40.1	6	
#4	0-11	68.4	68.7			137.1	3.8	3	
#8	0-7	7.4	28.0			35.4	1.0	2	
#16		0.2	3.6			3.8	0.1	2	
#30	0-6	0.1	1.8			1.9	0.1	1	
#50		0.1	1.6			1.7	0.0	1	
#100		0.1	2.2			2.3	0.1	1	
#200	0.1-2.1	0.1	4.0			4.1	0.1	1.2	
PAN	---	1.4	1.3			2.7	0.1		

B = INITIAL DRY MASS: 3653.5 **D = MASS AFTER SIEVING:** 3609.4

SIEVE SIZE	SPECS. LIMITS	FRACTURE % METHOD 2 AASHTO T 335				ELONGATED PIECES	
		FRAC MASS (F)	QUESTIONABLE MASS (Q)	NON FRAC MASS (N)	INDIVIDUAL FRAC %	TEST MASS	ELONG MASS
1/2"	75%	443.2	0.0	0.0	100%		
3/8"	----						
1/4"	----						
#4	75%	3114.3	0.0	0.0	100%	1188.4	30.0
#8	75%	<5%					

SE T 176			
1	2	3	Sample
			Clay
			Sand
			S.E.
AVG.		SPEC	
PAN TARE			1330.5
WET MASS & PAN			5032.5
DRY MASS & PAN			4984.0
AFTER WASH DRY MASS & PAN			4940.5

C = AFTER WASH DRY MASS & PAN - PAN B = DRY MASS & PAN - PAN DRY WET WAQTC AASHTO T-27/T11
 A = WET MASS & PAN - PAN RESULT SPEC Round Square Rectangle Size

Fracture % Method 1	T 335		
Wood Waste TM225	3.2	0.09 %	0.10%
Cleanness Value	TM 227		
Flat & Elongated	TM 229	2.5%	10.0%
Fineness Modulus	T 27/T11		
MOISTURE % = ((A-B) / B) X 100		1.3%	
SIEVE LOSS % = ((C-D) / C) X 100		0.0%	<0.3%
(N ₁₀ / 1/4") x 100			

**R
E
M
A
R
K
S**

<input type="checkbox"/> QUALITY CONTROL	<input checked="" type="checkbox"/> VERIFICATION	<input checked="" type="checkbox"/> INDEPENDENT ASSURANCE
CERTIFIED TECHNICIAN (PLEASE PRINT) AND CARD NUMBER Josh Huber #42332	COMPANY NAME ODOT Region 1 QA	SIGNATURE _____ DATE 4/27/2015

FIELD WORKSHEET FOR AGGREGATE

E English (E) or Metric (M)

PROJECT NAME (SECTION) Forms Example				CONTRACT NUMBER 12345	
CONTRACTOR OR SUPPLIER ODOT Forms			PROJECT MANAGER Sean Parker		BID ITEM NUMBER 123
SOURCE NAME Good Rock Bar			SOURCE NUMBER 10-123-3		MATERIAL SIZE 3/4"-0
TEST NO. 1	DATE 10/10/2012	TIME 7:30am	SAMPLED AT Final Belt		TO BE USED IN Base Aggregate

SIEVE SIZE	SPECS. LIMITS	SIEVE ANALYSIS AASHTO T27/11							FM CUMULATIVE % RETAINED
		MASS 1	MASS 2	MASS 3	MASS 4	TOTAL MASS	% RET	% PASS	
1"	100	0.0	0.0			0.0	0.0	100	
3/4"	90-100	88.3	170.2			258.5	4.8	95	
1/2"	---	446.3	381.5			827.8	15.4	80	
3/8"	55-75	223.8	247.7			471.5	8.8	71	
1/4"	40-60	311.8	347.5			659.3	12.3	59	
#4	---	252.7	193.6			446.3	8.3	50	
#6	---	298.8	165.1			463.9	8.7	42	
#10	---	287.4	222.1			509.5	9.5	32	
						0.0	0.0	32	
						0.0	0.0	32	
						0.0	0.0	32	
						0.0	0.0	32	
						0.0	0.0	32	
						0.0	0.0	32.2	
PAN	---	864.8	857.5			1722.3	32.1		

B = INITIAL DRY MASS: 5361.1 **D = MASS AFTER SIEVING:** 5359.1

SIEVE SIZE	SPECS. LIMITS	FRACTURE % METHOD 2 AASHTO T 335			ELONGATED PIECES	
		FRAC MASS (F)	QUESTIONABLE MASS (Q)	NON FRAC MASS (N)	INDIVIDUAL FRAC %	TEST MASS
1"		0.0	0.0	0.0		
3/4"		248.1	0.0	10.4		
1/2"		765.7	0.0	62.1		
3/8"		436.9	0.0	34.6		
1/4"		659.5	0.0	0.0		

SE T 176			
1	2	3	Sample
6.9	6.7	6.4	Clay
3.4	3.4	3.3	Sand
50	51	52	S.E.
AVG.	51	SPEC	30
PAN TARE			2516.3
WET MASS & PAN			8145.4
DRY MASS & PAN			7877.4
AFTER WASH DRY MASS & PAN			7877.4

C = AFTER WASH DRY MASS & PAN - PAN B = DRY MASS & PAN - PAN DRY WET WAQTC AASHTO T-27/T11
 A = WET MASS & PAN - PAN RESULT SPEC Round Square Rectangle Size

Fracture % Method 1	T 335	95%	70-100%
Wood Waste TM225		%	
Cleanness Value	TM 227		
Flat & Elongated	TM 229		
Fineness Modulus	T 27/T11		
MOISTURE % = ((A-B) / B) X 100		5.0%	
SIEVE LOSS % = ((C-D) / C) X 100		0.0%	0.3 Max
(N#10 / 1/4") x 100		54%	40-60

REMARKS

<input checked="" type="checkbox"/> QUALITY CONTROL	<input type="checkbox"/> VERIFICATION	<input type="checkbox"/> INDEPENDENT ASSURANCE
CERTIFIED TECHNICIAN (PLEASE PRINT) AND CARD NUMBER Scott Aker #43048	COMPANY NAME ODOT Region 3 QA Unit	SIGNATURE _____ DATE 4/27/2015

FIELD WORKSHEET FOR AGGREGATE

E English (E) or Metric (M)

PROJECT NAME (SECTION) Forms Example				CONTRACT NUMBER 12345	
CONTRACTOR OR SUPPLIER ODOT Forms			PROJECT MANAGER Sean Parker		BID ITEM NUMBER 123
SOURCE NAME Good Rock Bar			SOURCE NUMBER 10-123-3		MATERIAL SIZE #4-0
TEST NO. 1	DATE 10/10/2012	TIME 7:30am	SAMPLED AT Stockpile		TO BE USED IN PCC Fine Aggregate

SIEVE SIZE	SPECS. LIMITS	SIEVE ANALYSIS AASHTO T27/11							FM CUMULATIVE % RETAINED
		MASS 1	MASS 2	MASS 3	MASS 4	TOTAL MASS	% RET	% PASS	
						0.0	0.0	100	
						0.0	0.0	100	
						0.0	0.0	100	
						0.0	0.0	100	
						0.0	0.0	100	
						0.0	0.0	100	
3/8	100	0.0				0.0	0.0	100	
#4	90-100	1.3				1.3	0.1	100	0
#8	70-100	133.7				133.7	12.8	87	13
#16	50-85	192.4				192.4	18.5	69	31
#30	25-60	281.9				281.9	27.1	42	58
#50	5-30	260.9				260.9	25.0	17	83
#100	0-10	104.4				104.4	10.0	7	93
#200	0.0-4.0	38.9				38.9	3.7	2.8	
PAN	---	3.5				3.5	0.3		

B = INITIAL DRY MASS: 1041.8 **D = MASS AFTER SIEVING:** 1017.0

SIEVE SIZE	SPECS. LIMITS	FRACTURE % METHOD 2 AASHTO T 335				ELONGATED PIECES	
		FRAC MASS (F)	QUESTIONABLE MASS (Q)	NON FRAC MASS (N)	INDIVIDUAL FRAC %	TEST MASS	ELONG MASS

SE T 176			
1	2	3	Sample
4.5	4.6		Clay
3.5	3.6		Sand
78	79		S.E.
AVG.	79	SPEC	68
PAN TARE			1303.4
WET MASS & PAN			2418.0
DRY MASS & PAN			2345.2
AFTER WASH DRY MASS & PAN			2320.4

C = AFTER WASH DRY MASS & PAN - PAN **B = DRY MASS & PAN - PAN** DRY WET WAQTC AASHTO T-27/T11
A = WET MASS & PAN - PAN **RESULT** **SPEC** Round Square Rectangle Size

Fracture % Method 1	T 335		
Wood Waste TM225			%
Cleanness Value	TM 227		
Flat & Elongated	TM 229		
Fineness Modulus	T 27/T11	2.78	2.60-3.00
MOISTURE % = ((A-B) / B) X 100		7.0%	
SIEVE LOSS % = ((C-D) / C) X 100		0.0%	0.3 Max
(No 10 / 1/4") x 100			

REMARKS

<input checked="" type="checkbox"/> QUALITY CONTROL	<input type="checkbox"/> VERIFICATION	<input type="checkbox"/> INDEPENDENT ASSURANCE
CERTIFIED TECHNICIAN (PLEASE PRINT) AND CARD NUMBER Scott Aker #43048	COMPANY NAME ODOT Region 3 QA Unit	SIGNATURE _____ DATE 4/27/2015

FIELD WORKSHEET FOR AGGREGATE

M English (E) or Metric (M)

PROJECT NAME (SECTION) <div style="text-align: center;">Forms Example</div>				CONTRACT NUMBER <div style="text-align: center;">12345</div>	
CONTRACTOR OR SUPPLIER <div style="text-align: center;">ODOT Forms</div>			PROJECT MANAGER <div style="text-align: center;">Sean Parker</div>		BID ITEM NUMBER <div style="text-align: center;">123</div>
SOURCE NAME <div style="text-align: center;">Good Rock Bar</div>			SOURCE NUMBER <div style="text-align: center;">10-123-3</div>		MATERIAL SIZE <div style="text-align: center;">3/4" -#4</div>
TEST NO. <div style="text-align: center;">1</div>	DATE <div style="text-align: center;">10/10/2012</div>	TIME <div style="text-align: center;">7:30am</div>	SAMPLED AT <div style="text-align: center;">Final Belt</div>		TO BE USED IN <div style="text-align: center;">PCC Coarse Aggregate</div>

SIEVE SIZE	SPECS. LIMITS	SIEVE ANALYSIS AASHTO T27/11							FM CUMULATIVE % RETAINED
		MASS 1	MASS 2	MASS 3	MASS 4	TOTAL MASS	% RET	% PASS	
						0.0	0.0	100	
						0.0	0.0	100	
						0.0	0.0	100	
						0.0	0.0	100	
1	100	0.0	0.0			0.0	0.0	100	
3/4	90-100	10.5	27.6			38.1	0.7	99	
1/2	---	747.1	927.2			1674.3	30.1	69	
3/8	20-55	751.3	792.9			1544.2	27.8	41	
1/4	---	990.4	1040.7			2031.1	36.6	5	
#4	0-10	91.7	58.0			149.7	2.7	2	
#6	---	22.1	18.9			41.0	0.7	1	
#8	0-5	5.4	6.9			12.3	0.2	1	
#30	---	3.3	8.0			11.3	0.2	1	
#200	0.0-1.0	2.3	8.3			10.6	0.2	0.8	
PAN	---	1.7	3.5			5.2	0.1		

B = INITIAL DRY MASS: 5555.1 **D** = MASS AFTER SIEVING: 5517.8

SIEVE SIZE	SPECS. LIMITS	FRACTURE % METHOD 2 AASHTO T 335				ELONGATED PIECES	
		FRAC MASS (F)	QUESTIONABLE MASS (Q)	NON FRAC MASS (N)	INDIVIDUAL FRAC %	TEST MASS	ELONG MASS

SE T 176			
1	2	3	Sample
			Clay
			Sand
			S.E.
AVG.		SPEC	
PAN TARE			1329.3
WET MASS & PAN			7060.6
DRY MASS & PAN			6884.4
AFTER WASH DRY MASS & PAN			6848.2

C = AFTER WASH DRY MASS & PAN - PAN B = DRY MASS & PAN - PAN DRY WET WAQTC AASHTO T-27/T11
 A = WET MASS & PAN - PAN RESULT SPEC Round Square Rectangle Size

Fracture % Method 1	T 335		
Wood Waste TM225	0.8	0.01 %	0.05%
Cleanness Value	TM 227		
Flat & Elongated	TM 229		
Fineness Modulus	T 27/T11		
MOISTURE % = ((A-B) / B) X 100		3.2%	
SIEVE LOSS % = ((C-D) / C) X 100		0.0%	0.3 Max
(2.00 / 6.3) x 100			

R
E
M
A
R
K
S

Woodwaste = 0.8 grams

<input checked="" type="checkbox"/> QUALITY CONTROL	<input type="checkbox"/> VERIFICATION	<input type="checkbox"/> INDEPENDENT ASSURANCE
CERTIFIED TECHNICIAN (PLEASE PRINT) AND CARD NUMBER <div style="text-align: center;">Scott Aker #43048</div>	COMPANY NAME <div style="text-align: center;">ODOT Region 3 QA Unit</div>	SIGNATURE _____ DATE <div style="text-align: right;">4/27/2015</div>

NUCLEAR COMPACTION TEST REPORT FOR ACP

E English (E) or Metric (M)

PROJECT NAME (SECTION)					CONTRACT NUMBER					
CONTRACTOR OR SUPPLIER				PROJECT MANAGER				BID ITEM NUMBER		
DOT MIX DESIGN NO.		JMF PLACEMENT TEMP °F		LIFT THICKNESS		TYPE GAUGE-SERIAL NUMBER			MATERIAL TYPE	
MEASURED PLACEMENT TEMP °F		PANEL WIDTH			CONTROL STRIP NO.		LOT-SUBLOT		LIFT	DATE
ROLLER TYPE AND DESCRIPTION (MANUFACTURE, WEIGHT, ETC)					CODES FOR ROLLER TYPES					
BREAKDOWN					P - PNEUMATIC TS - TANDEM STEEL 3WS - THREE WHEEL STEEL SDV-SINGLE DRUM VIBRATORY DDV-DOUBLE DRUM VIBRATORY					
INTERMEDIATE										
FINISH										
TEST NUMBER										
DATE OF TEST										
TEST LOCATION (STATION)										
DISTANCE LT. OR RT. OF CENTERLINE FEET										
DIST BELOW LIFT										
LIFT GRADE THICKNESS										
Core Correlation ID										
DENSITY lb/ft³		1								
Max difference 2.5 lb/ft³		2								
AVERAGE DENSITY (LINE 1 + LINE 2) / 2		3								
Core Correlation Factor		4								
CORE TO NUCLEAR CORRELATION LINE 3 + LINE 4		5								
MAMD										
TARGET DENSITY lb/ft³		6								
% COMPACTION FOR INDIVIDUAL TESTS (LINE 3 OR 5 / LINE 6) X 100		7								
SUBLOT OR SECTION LINE 6 AVERAGE		% REQUIRED								
REPRESENTS MATERIAL INCORPORATED										
FROM STATION <input type="text"/>				TO STATION <input type="text"/>						
FROM OFFSET <input type="text"/>				TO OFFSET <input type="text"/>						
CIRCLE DIRECTION NB SB EB WB				CIRCLE LANE S A B C D S						
REMARKS										
<input type="checkbox"/> QUALITY CONTROL					<input type="checkbox"/> VERIFICATION					
CERTIFIED TECHNICIAN (PLEASE PRINT) AND CARD NUMBER				COMPANY NAME			SIGNATURE		DATE	

NUCLEAR COMPACTION TEST REPORT FOR ACP

E English (E) or Metric (M)

PROJECT NAME (SECTION) Forms Example				CONTRACT NUMBER 12345		
CONTRACTOR OR SUPPLIER ODOT Forms			PROJECT MANAGER Sean Parker		BID ITEM NUMBER 123	
ODOT MIX DESIGN NO. 18-MD0001	JMF PLACEMENT TEMP °F 288-297	LIFT THICKNESS See Table	TYPE GAUGE-SERIAL NUMBER See Table		MATERIAL TYPE L4 1/2" ACP	
MEASURED PLACEMENT TEMP °F 290	PANEL WIDTH 13 ft		CONTROL STRIP NO. 1	LOT-SUBLOT 1-1	LIFT 1st	
ROLLER TYPE AND DESCRIPTION (MANUFACTURE, WEIGHT, ETC)					CODES FOR ROLLER TYPES	
BREAKDOWN	CAT PF - 300B - 25 ton - P				P - PNEUMATIC	
INTERMEDIATE	IR DD130 - 14 ton - DDV				TS - TANDEM STEEL	
FINISH	Dynapac CC412 - 10 ton - DDV				3WS - THREE WHEEL STEEL	
SDV-SINGLE DRUM VIBRATORY						
DDV-DOUBLE DRUM VIBRATORY						
TEST NUMBER	1-1-1	1-1-2	1-1-3	1-1-4	1-1-5	
DATE OF TEST	10/10/2018	10/10/2018	10/10/2018	10/11/2018	10/11/2018	
TEST LOCATION (STATION)	24+98	25+32	64+99	67+21	67+50	
DISTANCE LT. OR RT. OF CENTERLINE FEET	6.5' Rt	7.6' Rt	10.0' Rf	2.1' Rt	4.1' Rt	
DIST BELOW LIFT GRADE THICKNESS	1st - 2" - 2"		1st - 2" - 2"		1st - 2" - 2"	
Core Correlation ID						
DENSITY lb/ft³	1	148.7	152.6	154.2	151.2	
Max difference 2.5 lb/ft³	2	150.0	154.6	154.8	151.4	
AVERAGE DENSITY (LINE 1 + LINE 2) / 2	3	149.4	153.6	154.5	151.3	
Core Correlation Factor	4					
CORE TO NUCLEAR CORRELATION LINE 3 + LINE 4	5					
<input checked="" type="checkbox"/> MAMD TARGET DENSITY lb/ft³	6	162.6	162.6	162.6	162.6	
% COMPACTION FOR INDIVIDUAL TESTS (LINE 3 OR 5 / LINE 6) X 100	7	91.9%	94.5%	95.0%	93.1%	
SUBLOT OR SECTION LINE 6 AVERAGE	92.0	93.8%				
REPRESENTS MATERIAL INCORPORATED						
FROM STATION	15+00	TO STATION	72+00			
FROM OFFSET	Centerline	TO OFFSET	13' Rt			
CIRCLE DIRECTION	NB SB (B) VB	CIRCLE LANE	S A (B) C D S			
REMARKS						
<input checked="" type="checkbox"/> QUALITY CONTROL <input type="checkbox"/> VERIFICATION						
CERTIFIED TECHNICIAN (PLEASE PRINT) AND CARD NUMBER			COMPANY NAME	SIGNATURE	DATE	
Scott Aker #43048			ODOT		10/10/2018	

NUCLEAR COMPACTION TEST REPORT FOR ACP

E English (E) or Metric (M)

PROJECT NAME (SECTION) Forms Example					CONTRACT NUMBER 12345	
CONTRACTOR OR SUPPLIER ODOT Forms			PROJECT MANAGER Sean Parker		BID ITEM NUMBER 123	
ODOT MIX DESIGN NO. 18-MD0001	JMF PLACEMENT TEMP °F 288-297	LIFT THICKNESS See Table	TYPE GAUGE-SERIAL NUMBER See Table		MATERIAL TYPE L4 1/2" ACP	
MEASURED PLACEMENT TEMP °F 290	PANEL WIDTH 13 ft		CONTROL STRIP NO. 1	LOT-SUBLOT 1-1	LIFT 1st	DATE 10/10/2018
ROLLER TYPE AND DESCRIPTION (MANUFACTURE, WEIGHT, ETC)					CODES FOR ROLLER TYPES	
BREAKDOWN	CAT PF - 300B - 25 ton - P				P - PNEUMATIC	
INTERMEDIATE	IR DD130 - 14 ton - DDV				TS - TANDEM STEEL	
FINISH	Dynapac CC412 - 10 ton - DDV				3WS - THREE WHEEL STEEL	
SDV-SINGLE DRUM VIBRATORY						
DDV-DOUBLE DRUM VIBRATORY						
TEST NUMBER		1-1-1	1-1-2	1-1-3	1-1-4	1-1-5
DATE OF TEST		10/10/2018	10/10/2018	10/10/2018	10/11/2018	10/11/2018
TEST LOCATION (STATION)		24+98	25+32	64+99	67+21	67+50
DISTANCE LT. OR RT. OF CENTERLINE FEET		6.5' Rt	7.6' Rt	10.0' Rf	2.1' Rt	4.1' Rt
DIST BELOW LIFT GRADE THICKNESS	LIFT THICKNESS	1st - 2" - 2"	1st - 2" - 2"	1st - 2" - 2"	1st - 2" - 2"	1st - 2" - 2"
Core Correlation ID		12345-b	12345-b	12345-b	12345-h	12345-h
DENSITY lb/ft³	1	148.7	152.6	154.2	151.2	154.3
Max difference 2.5 lb/ft³	2	150.0	154.6	154.8	151.4	152.3
AVERAGE DENSITY (LINE 1 + LINE 2) / 2	3	149.4	153.6	154.5	151.3	153.3
Core Correlation Factor	4	1.2	1.2	1.2	0.9	0.9
CORE TO NUCLEAR CORRELATION LINE 3 + LINE 4	5	150.6	154.8	155.7	152.2	154.2
<input checked="" type="checkbox"/> MAMD TARGET DENSITY lb/ft³	6	162.6	162.6	162.6	162.6	162.6
% COMPACTION FOR INDIVIDUAL TESTS (LINE 3 OR 5 / LINE 6) X 100	7	92.6%	95.2%	95.8%	93.6%	94.8%
SUBLOT OR SECTION LINE 6 AVERAGE	% REQUIRED	92.0	94.4%			
REPRESENTS MATERIAL INCORPORATED						
FROM STATION	15+00	TO STATION	72+00			
FROM OFFSET	Centerline	TO OFFSET	13' Rt			
CIRCLE DIRECTION	NB SB <input checked="" type="checkbox"/> VB	CIRCLE LANE	S A <input checked="" type="checkbox"/> C D S			
REMARKS						
<input checked="" type="checkbox"/> QUALITY CONTROL	<input type="checkbox"/> VERIFICATION					
CERTIFIED TECHNICIAN (PLEASE PRINT) AND CARD NUMBER			COMPANY NAME		SIGNATURE DATE	
Scott Aker #43048			ODOT		10/10/2018	

NUCLEAR COMPACTION TEST REPORT FOR ACP

English (E) or Metric (M)

PROJECT NAME (SECTION)						CONTRACT NUMBER	
CONTRACTOR OR SUPPLIER				PROJECT MANAGER		BID ITEM NUMBER	
ODOT MIX DESIGN NO.	JMF PLACEMENT TEMP	LIFT THICKNESS	TYPE GAUGE-SERIAL NUMBER			MATERIAL TYPE	
MEASURED PLACEMENT TEMP	PANEL WIDTH		CONTROL STRIP NO.	LOT-SUBLOT	LIFT	DATE	

RANDOM TEST LOCATIONS AND OFFSETS

MAMD	COMPACTION %	PANEL DEPTH in	PANEL WIDTH ft	AVG VOLUME ft ³ /ton	CROSS SEC. ft ²	YIELD (FT/TON) ft/ton	SUBLOT SIZE tons	SUBLOT DIST. ft
$\frac{\text{AVG VOLUME } 2000 (1000)}{\text{MAMD} \times (\% \text{ REQ'D} / 100)} = \text{ft}^3/\text{ton} \text{ (m}^3/\text{Mg)}$		$\frac{\text{CROSS SECTION PANEL DEPTH } 12 (1000)}{\text{X PANEL WIDTH}} = \text{ft}^2 \text{ (m}^2)$		$\frac{\text{YIELD AVG VOLUME}}{\text{CROSS SEC.}} = \text{ft} / \text{ton} \text{ (m} / \text{Mg)}$		$\text{SUBLOT DIST. YIELD X SUBLOT SIZE} = \text{ft} \text{ (m)}$		

TEST NUMBER	(A) THREE RANDOM DIGITS X .001	(B) SUBLOT SEGMENT DISTANCE OR TONS (Sublot Total / 5)	(C) BEGINNING STATION OR TONAGE	TEST LOCATION (A X B) ± C	(D) TWO RANDOM DIGITS X .01	(E) WIDTH MATERIAL COVERS ft.	OFFSET DIST. FROM RIGHT EDGE ((E - 2) X D) + 1
SUBLOT: DISTANCE		DISTANCE <input type="checkbox"/> TONS <input type="checkbox"/>		AUTO-CALC. RANDOMS <input type="checkbox"/>	ASCENDING DESCENDING <input type="checkbox"/>		

ROLLER TYPE AND DESCRIPTION (MANUFACTURE, WEIGHT, ETC)				
P - PNEUMATIC	TS - TANDEM STEEL	3WS - THREE WHEEL STEEL	SDV - SINGLE DRUM VIBRATORY	DDV - DOUBLE DRUM VIBRATORY
BREAKDOWN		INTERMEDIATE		FINISH

TEST NUMBER					
DATE OF TEST					
TEST LOCATION (STATION)					
OFFSET (FEET OR METERS)					
DIST BELOW LIFT GRADE	LIFT THICKNESS				
Core Correlation ID					
DENSITY	1				
Max difference 2.5 lb/ft ³ or 40 kg/m ³	2				
AVG DENSITY (LINE 1 + LINE 2) / 2	3				
Core Correlation Factor	4				
Core to Nuclear Correlation LINE 3 + LINE 4	5				
<input type="checkbox"/> MAMD <input type="checkbox"/> TARGET DENSITY	6				
% COMPACTION (LINE 3 OR 5 / LINE 6) X 100	7				
LINE 6 AVERAGE % REQUIRED					

REPRESENTS MATERIAL INCORPORATED					
FROM STATION	<input type="text"/>	OFFSET	<input type="text"/>	TO STATION	<input type="text"/>
CIRCLE DIRECTION NB SB EB WB		CIRCLE LANE S A B C D S			

REMARKS

QUALITY CONTROL	VERIFICATION
CERTIFIED TECHNICIAN (PLEASE PRINT) AND CARD NUMBER	COMPANY NAME
SIGNATURE	DATE

NUCLEAR COMPACTION TEST REPORT FOR ACP

E English (E) or Metric (M)

PROJECT NAME (SECTION) 2.5				Forms Example				CONTRACT NUMBER 12345	
CONTRACTOR OR SUPPLIER ODOT Forms				PROJECT MANAGER Sean Parker				BID ITEM NUMBER 123	
ODOT MIX DESIGN NO. 18-MD0001		JMF PLACEMENT TEMP °F 288-297		LIFT THICKNESS 2"		TYPE GAUGE-SERIAL NUMBER Troxler 3430 #11111			MATERIAL TYPE L3 1/2" Dense
MEASURED PLACEMENT TEMP °F 290		PANEL WIDTH 16'		CONTROL STRIP NO. 1		LOT-SUBLOT 1-1		LIFT 1st	DATE 10/10/2018

RANDOM TEST LOCATIONS AND OFFSETS

MAMD	COMPACTION	PANEL DEPTH	PANEL WIDTH	AVG VOLUME	CROSS SEC.	YIELD (FT/TON)	SUBLOT SIZE	SUBLOT DIST.
151.9	92.0 %	2 in	16 ft	14.32 ft³/ton	2.67 ft²	5.36 ft/ton	1000 tons	5360 ft
AVG VOLUME 2000 (1000)		CROSS SECTION PANEL DEPTH		YIELD		SUBLOT DIST.		
= ft³/ton (MAMD x (% REQD / 100))		= ft³/Mg 12 (1000) X PANEL WIDTH = ft² (m²)		= ft / ton CROSS SEC.		YIELD X SUBLOT SIZE = ft (m)		

TEST NUMBER	(A) THREE RANDOM DIGITS X .001	(B) SUBLOT SEGMENT DISTANCE OR TONS (Sublot Total / 5)	(C) BEGINNING STATION OR TONAGE	TEST LOCATION (A X B) ± C	(D) TWO RANDOM DIGITS X .01	(E) WIDTH MATERIAL COVERS ft.	OFFSET DIST. FROM RIGHT EDGE ((E - 2) X D) + 1
1-1	0.254	1072	12345	12617	0.24	16.0	4.4
1-2	0.564	1072	13417	14022	0.15	16.0	3.1
1-3	0.854	1072	14489	15404	0.50	16.0	8.0
1-4	0.125	1072	15561	15695	0.80	16.0	12.2
1-5	0.025	1072	16633	16660	0.92	16.0	13.9

SUBLOT: DISTANCE	5360	DISTANCE <input checked="" type="checkbox"/>	TONS <input type="checkbox"/>	AUTO-CALC. RANDOMS <input checked="" type="checkbox"/>	ASCENDING DESCENDING <input checked="" type="checkbox"/>	<input checked="" type="checkbox"/>
------------------	-------------	--	-------------------------------	--	--	-------------------------------------

ROLLER TYPE AND DESCRIPTION (MANUFACTURE, WEIGHT, ETC)			
P - PNEUMATIC	TS - TANDEM STEEL	3WS - THREE WHEEL STEEL	SDV - SINGLE DRUM VIBRATORY
BREAKDOWN		INTERMEDIATE	
CAT PF - 300B - 25ton - P		IR DD130 - 14ton - DDV	
		Dynapac CC412 - 10ton - DDV	

TEST NUMBER	1-1	1-2	1-3	1-4	1-5
DATE OF TEST	10/10/2018	10/10/2018	10/10/2018	10/10/2018	10/10/2018
TEST LOCATION (STATION)	126+17	140+22	154+04	156+95	166+60
OFFSET (FEET OR METERS)	3.6' Rt	4.9' Rt	CL	4.2' Lt	5.9' Lt
LIFT DIST BELOW GRADE	1st 2" 2"	1st 2" 2"	1st 2" 2"	1st 2" 2"	1st 2" 2"
LIFT THICKNESS					
Core Correlation ID					
DENSITY lb/ft³	1 148.7	152.6	154.2	151.2	154.3
Max difference 2.5 lb/ft³	2 150.0	154.6	154.8	151.4	152.3
AVG DENSITY (LINE 1 + LINE 2) / 2	3 149.4	153.6	154.5	151.3	153.3
Core Correlation Factor	4				
Core to Nuclear Correlation LINE 3 + LINE 4	5				
<input checked="" type="checkbox"/> MAMD TARGET DENSITY	6 162.6	162.6	162.6	162.6	162.6
% COMPACTION (LINE 3 OR 5 / LINE 6) X 100	7 91.9%	94.5%	95.0%	93.1%	94.3%
LINE 6 AVERAGE REQUIRED	92.0%				
	93.8%				

REPRESENTS MATERIAL INCORPORATED

FROM STATION 123+45	OFFSET 8' Lt	TO STATION 177+05	OFFSET 8' Rt
CIRCLE DIRECTION NB (SB) EB WB		CIRCLE LANE S A (B) C D S	

REMARKS

<input checked="" type="checkbox"/> QUALITY CONTROL	VERIFICATION
CERTIFIED TECHNICIAN (PLEASE PRINT) AND CARD NUMBER Scott Aker #43048	COMPANY NAME ODOT
SIGNATURE	DATE 10/10/2018

NUCLEAR COMPACTION TEST REPORT FOR ACP

E English (E) or Metric (M)

PROJECT NAME (SECTION) 2.5				Forms Example		CONTRACT NUMBER 12345	
CONTRACTOR OR SUPPLIER ODOT Forms				PROJECT MANAGER Sean Parker		BID ITEM NUMBER 123	
ODOT MIX DESIGN NO. 18-MD0001		JMF PLACEMENT TEMP °F 288-297	LIFT THICKNESS 2"	TYPE GAUGE-SERIAL NUMBER Troxler 3430 #11111		MATERIAL TYPE L3 1/2" Dense	
MEASURED PLACEMENT TEMP °F 290		PANEL WIDTH 16'		CONTROL STRIP NO. 1	LOT-SUBLOT 1-1	LIFT 1st	DATE 10/10/2018

RANDOM TEST LOCATIONS AND OFFSETS

MAMD 151.9	COMPACTION 92.0 %	PANEL DEPTH 2 in	PANEL WIDTH 16 ft	AVG VOLUME 14.32 ft³/ton	CROSS SEC. 2.67 ft²	YIELD (FT/TON) 5.36 ft/ton	SUBLOT SIZE 1000 tons	SUBLOT DIST. 5360 ft
AVG VOLUME 2000 (1000) = ft³/ton (MAMD x (% REQ'D / 100))		CROSS SECTION PANEL DEPTH X PANEL WIDTH = ft² (m²)		YIELD AVG VOLUME = ft / ton CROSS SEC.		SUBLOT DIST. YIELD X SUBLOT SIZE = ft (m)		

TEST NUMBER	(A) THREE RANDOM DIGITS X .001	(B) SUBLOT SEGMENT DISTANCE OR TONS (Sublot Total / 5)	(C) BEGINNING STATION OR TONAGE	TEST LOCATION (A X B) ± C	(D) TWO RANDOM DIGITS X .01	(E) WIDTH MATERIAL COVERS ft.	OFFSET DIST. FROM RIGHT EDGE ((E - 2) X D) + 1
1-1	0.254	1072	12345	12617	0.24	16.0	4.4
1-2	0.564	1072	13417	14022	0.15	16.0	3.1
1-3	0.854	1072	14489	15404	0.50	16.0	8.0
1-4	0.125	1072	15561	15695	0.80	16.0	12.2
1-5	0.025	1072	16633	16660	0.92	16.0	13.9

SUBLOT: DISTANCE	5360	AUTO-CALC. DISTANCE <input checked="" type="checkbox"/> TONS <input type="checkbox"/>	RANDOMS <input checked="" type="checkbox"/>	ASCENDING DESCENDING <input checked="" type="checkbox"/>	<input checked="" type="checkbox"/>
------------------	-------------	---	---	--	-------------------------------------

ROLLER TYPE AND DESCRIPTION (MANUFACTURE, WEIGHT, ETC)			
P - PNEUMATIC	TS - TANDEM STEEL	3WS - THREE WHEEL STEEL	SDV-SINGLE DRUM VIBRATORY
BREAKDOWN		INTERMEDIATE	
CAT PF - 300B - 25ton - P		IR DD130 - 14ton - DDV	
DDV-DOUBLE DRUM VIBRATORY			
FINISH			
Dynapac CC412 - 10ton - DDV			

TEST NUMBER	1-1	1-2	1-3	1-4	1-5
DATE OF TEST	10/10/2018	10/10/2018	10/10/2018	10/10/2018	10/10/2018
TEST LOCATION (STATION)	126+17	140+22	154+04	156+95	166+60
OFFSET (FEET OR METERS)	3.6' Rt	4.9' Rt	CL	4.2' Lt	5.9' Lt
LIFT DIST BELOW GRADE	1st 2" 2"	1st 2" 2"	1st 2" 2"	1st 2" 2"	1st 2" 2"
LIFT THICKNESS	2" 2"	2" 2"	2" 2"	2" 2"	2" 2"
Core Correlation ID	12345-b	12345-b	12345-b	12345-h	12345-h
DENSITY lb/ft³	1 148.7	152.6	154.2	151.2	154.3
Max difference 2.5 lb/ft³	2 150.0	154.6	154.8	151.4	152.3
AVG DENSITY (LINE 1 + LINE 2) / 2	3 149.4	153.6	154.5	151.3	153.3
Core Correlation Factor	4 1.2	1.2	1.2	0.9	0.9
Core to Nuclear Correlation LINE 3 + LINE 4	5 150.6	154.8	155.7	152.2	154.2
X MAMD TARGET DENSITY	6 162.6	162.6	162.6	162.6	162.6
% COMPACTION (LINE 3 OR 5 / LINE 6) X 100	7 92.6%	95.2%	95.8%	93.6%	94.8%
LINE 6 AVERAGE % REQUIRED	92.0%				
94.4%					

REPRESENTS MATERIAL INCORPORATED					
FROM STATION	123+45	OFFSET	8' Lt	TO STATION	177+05
				OFFSET	8' Rt
CIRCLE DIRECTION NB <input checked="" type="checkbox"/> EB WB		CIRCLE LANE S A <input checked="" type="checkbox"/> C D S			

REMARKS

<input checked="" type="checkbox"/> QUALITY CONTROL	VERIFICATION
CERTIFIED TECHNICIAN (PLEASE PRINT) AND CARD NUMBER Scott Aker #43048	COMPANY NAME ODOT
SIGNATURE	DATE 10/10/2018

NUCLEAR COMPACTION TEST FOR ACP

PROJECT NAME (SECTION)		E English	
CONTRACTOR OR SUPPLIER		ODOT MIX DESIGN NO.	CONTRACT NUMBER
PROJECT MANAGER		CONTRACTOR MIX DESIGN NO.	BID ITEM NUMBER
MEASURED PLACEMENT TEMP °F	JMF PLACEMENT TEMP °F	TYPE GAUGE-SERIAL NUMBER	MIX NOMINAL SIZE
BREAKDOWN ROLLER	INTERMEDIATE ROLLER	CONTROL STRIP NO.	LIFT
		LIFT THICKNESS	DATE
ROLLER TYPE AND DESCRIPTION (MANUFACTURE, WEIGHT, ETC) P - PNEUMATIC TS - TANDEM STEEL 3WS - THREE WHEEL STEEL SDV - SINGLE DRUM VIBRATORY DDV - DOUBLE DRUM VIBRATORY			
TEST NUMBER			
DATE OF TEST			
LOCATION (STATION)			
OFFSET (FEET)			
LIFT	DISTANCE BELOW GRADE	LIFT	
	THICKNESS		
DIRECTION OF TRAVEL			
	NB	SB	EB
	WB		
TRAVEL LANE			
	LS	A	B
	C	D	RS
CORE CORRELATION ID			
DENSITY lb/ft³	1		
MAX DIFFERENCE 2.5 lb/ft³	2		
AVG DENSITY (LINE 1 + 2) / 2	3		
CORE CORRELATION	4		
CORE TO NUCLEAR CORRELATION	5		
<input type="checkbox"/> IMMID <input type="checkbox"/> TARGET DENSITY	6		
% COMPACTION (LINE 3 OR 4 / LINE 5) X 100	7		
LINE 6			
AVG			
REPRESENTS MATERIAL INCORPORATED			
FROM STATION	OFFSET	TO STATION	OFFSET
REMARKS			
CERTIFIED TECHNICIAN (PLEASE PRINT) AND CARD NUMBER		COMPANY NAME	SIGNATURE
			DATE
			QUALITY CONTROL VERIFICATION INDEPENDENT ASSURANCE

NUCLEAR COMPACTION TEST FOR ACP

PROJECT NAME (SECTION)		E English	
OR58: Pheasant Lane to Dexter		ODOT MIX DESIGN NO.	CONTRACT NUMBER
Stoney S & G		14-MD0957	19245
PROJECT MANAGER		CONTRACTOR MIX DESIGN NO.	BID ITEM NUMBER
Art Truff		LBS154B	570
MEASURED PLACEMENT TEMP °F	JMF PLACEMENT TEMP °F	TYPE GAUGE SERIAL NUMBER	MIX NOMINAL SIZE
305	300 - 315	Troxler 3430 / 3806	1/2"
BREAKDOWN ROLLER	INTERMEDIATE ROLLER	CONTROL STRIP NO.	LIFT
CAT - 300 - TS	Hamm HD 20i +	15	Base
	Hamm HD 110 VO +	3"	Base
			DATE
			7/31/2018

ROLLER TYPE AND DESCRIPTION (MANUFACTURE, WEIGHT, ETC)																
		P - PNEUMATIC			TS - TANDEM STEEL			3WS - THREE WHEEL STEEL			SDV - SINGLE DRUM VIBRATORY			DDV - DOUBLE DRUM VIBRATORY		
TEST NUMBER	DATE OF TEST	LOCATION (STATION)	OFFSET (FEET)	LIFT	6-25-1	6-25-2	6-25-3	6-25-4	6-25-5	6-25-6	6-25-7	6-25-8	6-25-9	6-25-10		
					7/31/18	7/31/18	7/31/18	7/31/18	7/31/18	7/31/18	7/31/18	7/31/18	7/31/18	7/31/18		
					501+33	505+87	508+47	512+75	514+90	518+43	522+49	523+50	525+91	529+00		
					14.4 ft Rt	17.2 ft Rt	10.9 ft Rt	8.6 ft Rt	16.1 ft Rt	17.7 ft Rt	10.0 ft Rt	2.0 ft Rt	4.4 ft Rt	12.0 ft Rt		
					Base / 3"	Base / 3"	Base / 3"	Base / 3"	Base / 3"	Wear / 2.5"	Wear / 2.5"	Wear / 2.5"	Wear / 2.5"	Wear / 2.5"		
					EB	EB	EB	EB	EB	EB	EB	EB	EB	EB		
					RS & B	RS & B	RS & B	RS & B	RS & B	RS & A	RS & A	RS & A	RS & A	RS & A		
CORE CORRELATION ID																
					1	144.2	144.7	140.4	145.1	144.6	142.8	140.7	142.8	146.5		
					2	143.6	145.1	140.1	145.5	145.5	143.2	140.1	143.6	147		
					3	143.9	144.9	140.3	145.3	145.1	143	140.4	143.2	146.8		
					4											
					5											
					6	153.9	153.9	153.9	153.9	153.9	153.9	153.9	153.9	153.9		
					7	93.5%	94.2%	91.2%	94.4%	94.3%	92.9%	91.2%	93.0%	95.4%		
					92.9%											

REPRESENTS MATERIAL INCORPORATED

FROM STATION	500+00	OFFSET	Varied	TO STATION	530+50	OFFSET	Varied
--------------	--------	--------	--------	------------	--------	--------	--------

REMARKS

QUALITY CONTROL VERIFICATION INDEPENDENT ASSURANCE

CERTIFIED TECHNICIAN (PLEASE PRINT) AND CARD NUMBER	COMPANY NAME	SIGNATURE	DATE
Scott Wales 49325	ODOT R2 QA		

NUCLEAR COMPACTION TEST FOR ACP

E English

PROJECT NAME (SECTION)		ODOT MIX DESIGN NO.		CONTRACT NUMBER	
OR58: Pheasant Lane to Dexter		14-MD0957		19245	
CONTRACTOR OR SUPPLIER		CONTRACTOR MIX DESIGN NO.		BID ITEM NUMBER	
Stoney S & G		LBS154B		570	
MEASURED PLACEMENT TEMP °F		TYPE GAUGE SERIAL NUMBER		MIX NOMINAL SIZE	
305		Troxler 3430 / 3806		1/2"	
BREAKDOWN ROLLER		CONTROL STRIP NO.		LIFT	
CAT - 300 - TS		15		Base	
INTERMEDIATE ROLLER		FINISH ROLLER		DATE	
Hamm HD 20i +		Hamm HD 110 VO +		7/31/2018	
Hamm HD 20i +		3"			

ROLLER TYPE AND DESCRIPTION (MANUFACTURE, WEIGHT, ETC)

TEST NUMBER	P - PNEUMATIC		TS - TANDEM STEEL		3WS - THREE WHEEL STEEL		SDV - SINGLE DRUM VIBRATORY		DDV - DOUBLE DRUM VIBRATORY	
	6-25-1	6-25-2	6-25-3	6-25-4	6-25-5	6-25-6	6-25-7	6-25-8	6-25-9	6-25-10
DATE OF TEST	7/31/18	7/31/18	7/31/18	7/31/18	7/31/18	7/31/18	7/31/18	7/31/18	7/31/18	7/31/18
LOCATION (STATION)	501+33	505+87	508+47	512+75	514+90	518+43	522+49	523+50	525+91	529+00
OFFSET (FEET)	14.4 ft Rt	17.2 ft Rt	10.9 ft Rt	8.6 ft Rt	16.1 ft Rt	17.7 ft Rt	10.0 ft Rt	2.0 ft Rt	4.4 ft Rt	12.0 ft Rt
LIFT	Base / 3"	Base / 3"	Base / 3"	Base / 3"	Base / 3"	Wear / 2.5"	Wear / 2.5"	Wear / 2.5"	Wear / 2.5"	Wear / 2.5"
DIRECTION OF TRAVEL	EB	EB	EB	EB	EB	EB	EB	EB	EB	EB
TRAVEL LANE	RS & B	RS & B	RS & B	RS & B	RS & B	RS & A	RS & A	RS & A	RS & A	RS & A
CORE CORRELATION ID	12345-a	12345-a	12345-a	12345-a	12345-a	12345-c	12345-c	12345-c	12345-c	12345-c
DENSITY lb/ft³	144.2	144.7	137.3	140.4	145.1	144.6	142.8	140.7	142.8	146.5
MAX DIFFERENCE 2.5 lb/ft³	143.6	145.1	137.1	140.1	145.5	145.5	143.2	140.1	143.6	147
AVG DENSITY (LINE 1 + 2) / 2	143.9	144.9	137.2	140.3	145.3	145.1	143	140.4	143.2	146.8
CORE CORRELATION	-0.8	-0.8	-0.8	-0.8	0.7	0.7	0.7	0.7	0.7	0.7
CORE TO NUCLEAR CORRELATION	143.1	144.1	136.4	139.5	146	145.8	143.7	141.1	143.9	147.5
MAMD TARGET DENSITY	153.9	153.9	153.9	153.9	153.9	153.9	153.9	153.9	153.9	153.9
% COMPACTION	93.0%	93.6%	88.6%	90.6%	94.9%	94.7%	93.4%	91.7%	93.5%	95.8%
LINE 6 AVG	93.0%									

REPRESENTS MATERIAL INCORPORATED

FROM STATION	500+00	OFFSET	Varied	TO STATION	530+50	OFFSET	Varied
---------------------	--------	---------------	--------	-------------------	--------	---------------	--------

REMARKS

QUALITY CONTROL VERIFICATION INDEPENDENT ASSURANCE

CERTIFIED TECHNICIAN (PLEASE PRINT) AND CARD NUMBER	Scott Wales 49325	COMPANY NAME	ODOT R2 QA	SIGNATURE		DATE	
--	-------------------	---------------------	------------	------------------	--	-------------	--

NUCLEAR COMPACTION TEST REPORT

E English (E) or Metric(M)

PROJECT NAME (SECTION)				CONTRACT NUMBER	
CONTRACTOR OR SUPPLIER			PROJECT MANAGER		BID ITEM NUMBER
TEST LOCATION (STATION)			OFFSET (DISTANCE FROM CENTERLINE)		SOURCE POSITION
TEST NUMBER	DISTANCE BELOW GRADE	LIFT	LIFT THICKNESS	DATE	
CODES FOR ROLLER TYPES SDV-SINGLE DRUM VIBRATORY SF-SHEEP FOOT DDV-DOUBLE DRUM VIBRATORY GR-GRID ROLLER			ROLLER TYPE AND DESCRIPTION (MANUFACTURE, WEIGHT, ETC)		

REPRESENTS MATERIAL / AREA INCORPORATED

FROM: STATION OFFSET DIST. BELOW GRADE
 TO: STATION OFFSET DIST. BELOW GRADE
 CHECK BOX DEFLECTION OBSERVED UNDER LOADED EQUIP. NO DEFLECTION OBSERVED UNDER LOADED EQUIP.
 MOISTURE IS NOT WITHIN SPECIFICATION MOISTURE IS WITHIN SPECIFICATION

AASHTO T 310	Wet Density	lb/ft ³	Moisture	lb/ft ³	Dry Density	Percent Moisture
Shot 1	<input type="text"/>	<input type="text"/>	<input type="text"/>	<input type="text"/>	WD - M	(M / DD) X 100
Shot 2	<input type="text"/>	<input type="text"/>	<input type="text"/>	<input type="text"/>		
Average	WD		M		DD	%M %

(shots within 2 lb/ft³)

AASHTO T 99	A	No.4	COARSE	<input type="text"/>	FINE	<input type="text"/>	% Coarse	<input type="text"/>
	D	3/4	COARSE	<input type="text"/>	FINE	<input type="text"/>	% Coarse	<input type="text"/>

MASS OF MOLD AND MATERIALS	MASS OF MOLD	MASS OF WET MATERIAL (M)	WET DENSITY lb/ft ³ (A)	SPEEDY MOISTURE %		AASHTO T 255 / T 265 MOISTURE %			DRY DENSITY lb/ft ³ (D)
				WET (B)	DRY (C)	WET (a)	DRY (b)	% M (c)	
UNSCREENED COMBINED IN-PLACE MOISTURE →				<input type="text"/>	<input type="text"/>	<input type="text"/>	<input type="text"/>	<input type="text"/>	<input type="text"/>
<input type="text"/>	<input type="text"/>	<input type="text"/>	<input type="text"/>	<input type="text"/>	<input type="text"/>	<input type="text"/>	<input type="text"/>	<input type="text"/>	<input type="text"/>

WD (A) = (M) X (MF) MOLD FACTOR MOLD FACTOR (MF) <input type="text"/>	SPEEDY MOISTURE % (C) = $\frac{(B)}{100 - (B)} \times 100$	T 255 / T 265 MOISTURE % (C) = $\frac{(a) - (b)}{(b)} \times 100$	DRY DENSITY (D) = $\frac{(A)}{(C)+100} \times 100$
--	---	--	---

4 inch MOLD (WD) = (M) x 0.06614	6 inch MOLD (WD) = (M) x 0.02939	Pc (from A or D above)	Pf (Pf = 100 - Pc)	CURVE NO.	DRY DENSITY ρ_f	OPTIMUM MOISTURE	Mcf	k (Gsb x 62.4)	MCc
<input type="text"/>	<input type="text"/>	<input type="text"/>	<input type="text"/>	<input type="text"/>	<input type="text"/>	<input type="text"/>	<input type="text"/>	<input type="text"/>	<input type="text"/>

COMBINED IN-PLACE MOISTURE (C) = unaltered one-point moisture Within 1% of T 310 % Moisture? (If not Correct T 310 DD)	$W = \frac{(C)P_f + MC_c P_c}{100}$ W = <input type="text"/>
COMBINED OPTIMUM MOISTURE (MCT) (Based on Curve Info.)	$MC_T = \frac{(MC_f P_f + MC_c P_c)}{100}$ MC _T = <input type="text"/>
RELATIVE MAXIMUM DRY DENSITY $\rho_d = \frac{100}{\frac{P_f}{\rho_f} + \frac{P_c}{k}}$	$\rho_d = \frac{100}{\frac{\text{input}}{\text{input}} + \frac{\text{input}}{\text{input}}}$

CORRECTED DRY DENSITY $DD = \frac{WD}{(1+(W/100))}$ DD = <input type="text"/> = $\frac{WD}{1+(W/100)}$	PERCENT COMPACTION Original or Corrected (DD / Dd) x 100 Percent Required <input type="text"/> PERCENT OBTAINED <input type="text"/>
--	---

REMARKS			
QUALITY CONTROL	VERIFICATION	TYPE GAUGE-SERIAL NUMBER:	
CERTIFIED TECHNICIAN (PLEASE PRINT) AND CARD NUMBER	COMPANY NAME	SIGNATURE	DATE

NUCLEAR COMPACTION TEST REPORT

E English (E) or Metric(M)

PROJECT NAME (SECTION) Forms Example				CONTRACT NUMBER 12345	
CONTRACTOR OR SUPPLIER ODOT Forms			PROJECT MANAGER Sean Parker		BID ITEM NUMBER 123
TEST LOCATION (STATION) 65+15			OFFSET (DISTANCE FROM CENTERLINE) 15' Rt.		SOURCE POSITION 8"
TEST NUMBER 1-1	DISTANCE BELOW GRADE Subgrade	LIFT N/A	LIFT THICKNESS N/A	DATE 10/9/20	
CODES FOR ROLLER TYPES SDV-SINGLE DRUM VIBRATORY DDV-DOUBLE DRUM VIBRATORY			ROLLER TYPE AND DESCRIPTION (MANUFACTURE, WEIGHT, ETC) CAT CF 560 SDV		
SF-SHEEP FOOT GR-GRID ROLLER					

REPRESENTS MATERIAL / AREA INCORPORATED

FROM: STATION **OFFSET** **DIST. BELOW GRADE**
TO: STATION **OFFSET** **DIST. BELOW GRADE**
CHECK BOX DEFLECTION OBSERVED UNDER LOADED EQUIP. NO DEFLECTION OBSERVED UNDER LOADED EQUIP.
 MOISTURE IS NOT WITHIN SPECIFICATION MOISTURE IS WITHIN SPECIFICATION

AASHTO T 310	Wet Density	lb/ft ³	Moisture	lb/ft ³	Dry Density	Percent Moisture
Shot 1	150.2		10.1		WD - M	(M / DD) X 100
Shot 2	150.9		10.3			
Average	WD 150.6		M 10.2		DD 140.4	%M 7.3 %

(shots within 2 lb/ft³)

AASHTO T 99	A	No4	COARSE	<input type="text" value="4582.0"/>	FINE	<input type="text" value="5939.0"/>	% Coarse	<input type="text" value="44"/>
	D	¾	COARSE	<input type="text" value="845.0"/>	FINE	<input type="text" value="9691.0"/>	% Coarse	<input type="text" value="8"/>

MASS OF MOLD AND MATERIALS	MASS OF MOLD	MASS OF WET MATERIAL (M)	WET DENSITY lb/ft ³ (A)	SPEEDY MOISTURE % WET (B)	DRY (C)	AASHTO T 255 / T 265 MOISTURE %			DRY DENSITY lb/ft ³ (D)
UNSCREENED COMBINED IN-PLACE MOISTURE →									
						2005.2	1850.1	8.4	
10317.0	5655.5	4661.5	137.0			1097.7	1065.3	3.0	133
10491.8	5655.5	4836.3	142.1			1044.7	991.1	5.4	134.8

WD (A) = (M) X (MF) MOLD FACTOR MOLD FACTOR (MF) <input type="text" value="0.02939"/>	SPEEDY MOISTURE % (C) = $\frac{(B)}{100 - (B)} \times 100$	T 255 / T 265 MOISTURE % (C) = $\frac{(a) - (b)}{(b)} \times 100$	DRY DENSITY (D) = $\frac{(A)}{(C)+100} \times 100$
---	--	---	--

Pc (from A or D above)	Pf (Pf = 100 - Pc)	CURVE NO.	DRY DENSITY ρ_f	OPTIMUM MOISTURE	MC_f	k (Gsb x 62.4)	MC_c
8	92	Exit 99-03	139.0	8.5		165	2.2

COMBINED IN-PLACE MOISTURE
 (C) = unaltered one-point moisture
 $W = \frac{(C)P_f + MC_c P_c}{100}$
 Within 1% of T 310 % Moisture? (If not Correct T 310 DD)
W = 8.4

COMBINED OPTIMUM MOISTURE (MCT)
 (Based on Curve Info.)
 $MC_T = \frac{(MC_f P_f + MC_c P_c)}{100}$
MC_T = 8.5

RELATIVE MAXIMUM DRY DENSITY
 $\rho_d = \frac{100}{\frac{P_f}{\rho_f} + \frac{P_c}{k}}$
ρ_d = 139.0

CORRECTED DRY DENSITY
 $DD = \frac{WD}{1 + (W/100)}$
DD = 138.9 = $\frac{150.6}{1 + (8.4/100)}$ = **1.084**

PERCENT COMPACTION
 Original or Corrected (DD / Dd) x 100
 Percent Required **PERCENT OBTAINED**

REMARKS

QUALITY CONTROL VERIFICATION
 TYPE GAUGE-SERIAL NUMBER: **Troxler 3430 #11111**

CERTIFIED TECHNICIAN (PLEASE PRINT) AND CARD NUMBER Scott Aker	COMPANY NAME #43048	SIGNATURE 	DATE 10/9/2020
--	-------------------------------	-------------------	--------------------------

NUCLEAR COMPACTION TEST REPORT

E English (E) or Metric(M)

PROJECT NAME (SECTION) Forms Example				CONTRACT NUMBER 12345	
CONTRACTOR OR SUPPLIER ODOT Forms			PROJECT MANAGER Sean Parker		BID ITEM NUMBER 123
TEST LOCATION (STATION) 117+17			OFFSET (DISTANCE FROM CENTERLINE) 16' Lt.		SOURCE POSITION 8"
TEST NUMBER 1-1	DISTANCE BELOW GRADE 7 ft.	LIFT 3 rd	LIFT THICKNESS 12"	DATE 10/9/20	
CODES FOR ROLLER TYPES SDV-SINGLE DRUM VIBRATORY DDV-DOUBLE DRUM VIBRATORY			ROLLER TYPE AND DESCRIPTION (MANUFACTURE, WEIGHT, ETC) CAT CF 460 SF		
SF-SHEEP FOOT GR-GRID ROLLER					

REPRESENTS MATERIAL / AREA INCORPORATED

FROM: STATION **115+25** OFFSET **15' Lt.** DIST. BELOW GRADE **8'**

TO: STATION **200+25** OFFSET **20' Rt.** DIST. BELOW GRADE **7'**

CHECK BOX DEFLECTION OBSERVED UNDER LOADED EQUIP. NO DEFLECTION OBSERVED UNDER LOADED EQUIP.

MOISTURE IS NOT WITHIN SPECIFICATION MOISTURE IS WITHIN SPECIFICATION

AASHTO T 310	Wet Density	lb/ft ³	Moisture	lb/ft ³	Dry Density	Percent Moisture
Shot 1	131.0		9.4		WD - M	(M / DD) X 100
Shot 2	131.1		9.4			
Average	WD 131.1		M 9.4		DD 121.7	%M 7.7 %

(shots within 2 lb/ft³)

AASHTO T 99	A	No.4	COARSE	8946.8	FINE	12948.7	% Coarse	41
	D	3/4	COARSE	5425.2	FINE	16470.3	% Coarse	25

MASS OF MOLD AND MATERIALS	MASS OF MOLD	MASS OF WET MATERIAL (M)	WET DENSITY lb/ft ³	SPEEDY MOISTURE % WET (B)	DRY (C)	AASHTO T 255 / T 265 MOISTURE %			DRY DENSITY lb/ft ³ (D)
			(A)			WET (a)	DRY (b)	% M (c)	
UNSCREENED COMBINED IN-PLACE MOISTURE →									
9815.3	5645.5	4169.8	122.6			4158.9	3718.5	11.8	109.7

WD (A) = (M) X (MF) MOLD FACTOR	SPEEDY MOISTURE %	T 255 / T 265 MOISTURE %	DRY DENSITY
MOLD FACTOR (MF) 0.02939	(C) = $\frac{(B)}{100 - (B)} \times 100$	(C) = $\frac{(a) - (b)}{(b)} \times 100$	(D) = $\frac{(A)}{(C) + 100} \times 100$
4 inch MOLD (WD) = (M) x 0.06614			
6 inch MOLD (WD) = (M) x 0.02939			

Pc	Pf	CURVE NO.	DRY DENSITY ρ _f	OPTIMUM MOISTURE	Mcf	k (Gsb x 62.4)	MCc
(from A or D above)	(Pf = 100 - Pc)	Exit 19-1	112.8	15.4		166.6	1.5

COMBINED IN-PLACE MOISTURE
(C) = unaltered one-point moisture

$$W = \frac{(C)P_f + MC_c P_c}{100}$$

Within 1% of T 310 % Moisture?
(If not Correct T 310 DD)

W = **9.2**

COMBINED OPTIMUM MOISTURE (MCT)
(Based on Curve Info.)

$$MC_T = \frac{(MC_f P_f + MC_c P_c)}{100}$$

MC_T = **11.9**

RELATIVE MAXIMUM DRY DENSITY

$$\rho_d = \frac{100}{\frac{P_f}{\rho_f} + \frac{P_c}{k}}$$

lb/ft³ ρ_d = **122.7** = $\frac{75}{112.8} + \frac{25}{166.6}$

CORRECTED DRY DENSITY

$$DD = \frac{WD}{(1 + (W/100))}$$

DD = **120.1** = $\frac{WD}{1 + (W/100)}$ = $\frac{131.1}{1.092}$

PERCENT COMPACTION

Original or Corrected (DD / Dd) x 100

Percent Required **95** PERCENT OBTAINED **98**

REMARKS

QUALITY CONTROL VERIFICATION TYPE GAUGE-SERIAL NUMBER: **Troxler 3430 #11111**

CERTIFIED TECHNICIAN (PLEASE PRINT) AND CARD NUMBER Scott Aker #43048	COMPANY NAME ODOT	SIGNATURE	DATE 10/9/2020
---	-----------------------------	-----------	--------------------------

NUCLEAR COMPACTION TEST REPORT FOR BASE AGGREGATE

E English (E) or Metric (M)

PROJECT NAME (SECTION)				CONTRACT NUMBER
CONTRACTOR OR SUPPLIER			PROJECT MANAGER	BID ITEM NUMBER
CONTROL STRIP NO.	PANEL WIDTH	LIFT THICKNESS	TYPE GAUGE-SERIAL NUMBER	MIX NOMINAL SIZE

ROLLER TYPE AND DESCRIPTION (MANUFACTURE, WEIGHT, ETC)

TEST NUMBER					
DATE OF TEST					
TEST LOCATION (STATION)					
DISTANCE LT. OR RT. OF CENTERLINE (FEET)					
SOURCE POSITION					
LIFT	DIST BELOW GRADE				

WET DENSITY lb/ft ³ MAX DIFFERENCE 2 lb/ft ³	1D				
	2D				
MOISTURE lb/ft ³	1M				
	2M				

AVE. WET DENSITY lb/ft ³	AD				
AVE. MOISTURE lb/ft ³	AM				
DRY DENSITY (AD-AM) lb/ft ³	DD				
% MOISTURE (AM / DD) x 100	%M				

Curve # - Source #					
RELATIVE MAXIMUM DRY DENSITY	RD				
Combined Optimum Moisture					

% COMPACTION (DD / RD) X 100		% REQ			
--------------------------------	--	-------	--	--	--

CHECK APPROPRIATE MATERIAL DEFLECTED UNDER LOADED EQUIPMENT MATERIAL DID NOT DEFLECT UNDER LOADED EQUIPMENT

REPRESENTS MATERIAL INCORPORATED

FROM STATION

FROM OFFSET

TO STATION

TO OFFSET

REMARKS

<input type="checkbox"/> QUALITY CONTROL	<input type="checkbox"/> VERIFICATION		
CERTIFIED TECHNICIAN (PLEASE PRINT) AND CARD NUMBER	COMPANY NAME	SIGNATURE	DATE

NUCLEAR COMPACTION TEST REPORT FOR BASE AGGREGATE

E English (E) or Metric (M)

PROJECT NAME (SECTION) Forms Example				CONTRACT NUMBER 12345
CONTRACTOR OR SUPPLIER ODOT Forms			PROJECT MANAGER Sean Parker	BID ITEM NUMBER 123
CONTROL STRIP NO.	PANEL WIDTH 13 ft	LIFT THICKNESS 6"	TYPE GAUGE-SERIAL NUMBER Troxler 3430 #11111	MIX NOMINAL SIZE 3/4"-0

ROLLER TYPE AND DESCRIPTION (MANUFACTURE, WEIGHT, ETC)
Ingersoll Rand - SDV - 10 ton

TEST NUMBER	1	2	3	4	5
DATE OF TEST	10/9/2012	10/9/2012	10/9/2012	10/9/2012	10/9/2012
TEST LOCATION (STATION)	135+15	142+50	148+30	155+45	161+00
DISTANCE LT. OR RT. OF CENTERLINE (FEET)	5' Rt	2' Rt	10' Rt	9' Rt	3' Rt
SOURCE POSITION	6"	6"	6"	6"	6"
LIFT DIST BELOW GRADE	1st 6"	1st 6"	1st 6"	1st 6"	1st 6"
WET DENSITY lb/ft ³	1D 144.4	145.6	147	146.5	145.7
MAX DIFFERENCE 2 lb/ft ³	2D 143.8	145.3	147.2	146.5	145.9
MOISTURE lb/ft ³	1M 7.2	7.9	8.1	7.4	7.6
	2M 7.1	7.7	8.3	7.3	7.7
AVE. WET DENSITY lb/ft ³	AD 144.1	145.5	147.1	146.5	145.8
AVE. MOISTURE lb/ft ³	AM 7.2	7.8	8.2	7.4	7.7
DRY DENSITY (AD-AM) lb/ft ³	DD 136.9	137.7	138.9	139.1	138.1
% MOISTURE (AM / DD) x 100	%M 5.3%	5.7%	5.9%	5.3%	5.6%

Curve # - Source #		#1 10-001-3	#1 10-001-3	#1 10-001-3	#1 10-001-3	#1 10-001-3
RELATIVE MAXIMUM DRY DENSITY	RD	135.4	134.5	135.4	135.4	135.4
Combined Optimum Moisture		7.3%	7.3%	7.3%	7.3%	7.3%

% COMPACTION (DD / RD) X 100	95	% REQ	101%	102%	103%	103%	102%
-------------------------------------	-----------	-------	-------------	-------------	-------------	-------------	-------------

CHECK APPROPRIATE MATERIAL DEFLECTED UNDER LOADED EQUIPMENT MATERIAL DID NOT DEFLECT UNDER LOADED EQUIPMENT

REPRESENTS MATERIAL INCORPORATED FROM STATION TO STATION

FROM OFFSET TO OFFSET

REMARKS

<input checked="" type="checkbox"/> QUALITY CONTROL	<input type="checkbox"/> VERIFICATION		
CERTIFIED TECHNICIAN (PLEASE PRINT) AND CARD NUMBER Scott Aker #43048	COMPANY NAME ODOT	SIGNATURE	DATE 10/9/2012

UNIT WEIGHT AND SPECIFIC GRAVITY W/S

E

English (E) or Metric (M)

PROJECT NAME (SECTION)					CONTRACT NUMBER	
CONTRACTOR OR SUPPLIER			PROJECT MANAGER		BID ITEM NUMBER	
TEST NO.	DATE	TIME	SAMPLED AT	MATERIAL DESCRIPTION	TO BE USED IN	

BULK DENSITY ("UNIT WEIGHT") AND VOIDS IN AGGREGATE AASHTO T 19

SOURCE NAME					
SOURCE NUMBER					
MATERIAL SIZE					
A	MEASURE + AGGREGATE	lb			
B	EMPTY MEASURE	lb			
C	MASS OF AGGREGATE A-B	lb			
D	VOLUME OF MEASURE	ft ³			
UNIT WEIGHT		C / D	lb/ft ³		

SPECIFIC GRAVITY AND ABSORPTION OF COARSE AGGREGATE AASHTO T 85

SOURCE NAME					
SOURCE NUMBER					
MATERIAL SIZE					
A	MASS OF DRY SAMPLE	g			
B	MASS OF SSD SAMPLE	g			
C	WEIGHT IN WATER	g			
Gsb	A / (B - C)				
Gsb ssd	B / (B - C)				
Gsa	A / (A - C)				
Absorption	[(B - A) / A] X 100				

SPECIFIC GRAVITY AND ABSORPTION OF FINE AGGREGATE AASHTO T 84

PYCNOMETER METHOD			LeCHATELIER FLASK METHOD		
SOURCE NAME			SOURCE NAME		
SOURCE NUMBER			SOURCE NUMBER		
MATERIAL SIZE			MATERIAL SIZE		
S	MASS OF SSD SAMPLE	g	S₁	SSD MATERIAL IN FLASK (55±5)	g
A	MASS OF DRY SAMPLE	g	S	SEPARATE SSD SAMPLE (500±10)	g
B	MASS OF PYC + WATER	g	R₁	INITIAL FLASK READING	ml
C	PYCN + WATER + SAMPLE	g	R₂	FINAL FLASK READING	ml
Gsb	A / (B + S - C)		A	MASS OF DRY SAMPLE g	
Gsb ssd	S / (B + S - C)		Gsb	[S ₁ (A / S) / [0.9975 (R ₂ - R ₁)]]	
Gsa	A / (B + A - C)		Gsb ssd	S ₁ / [0.9975 (R ₂ - R ₁)]]	
Absorption	[(S - A) / A] X 100		Absorption	[(S - A) / A] X 100	

CERTIFIED TECHNICIAN (PLEASE PRINT) AND CARD NUMBER	COMPANY NAME	SIGNATURE	DATE
---	--------------	-----------	------

UNIT WEIGHT AND SPECIFIC GRAVITY W/S

E

English (E) or Metric (M)

PROJECT NAME (SECTION) Forms Example				CONTRACT NUMBER 12345	
CONTRACTOR OR SUPPLIER Super Concrete Ready Mix			PROJECT MANAGER Sean Parker		BID ITEM NUMBER 123
TEST NO. 07-1	DATE 10/5/2017	TIME 10:00am	SAMPLED AT Stockpile	MATERIAL DESCRIPTION Round/Crushed Blend	TO BE USED IN PCC Coarse Aggregate

BULK DENSITY ("UNIT WEIGHT") AND VOIDS IN AGGREGATE AASHTO T 19

SOURCE NAME		Best Rock	Best Rock	Best Rock
SOURCE NUMBER		12-123-3	12-123-3	12-123-3
MATERIAL SIZE		85% 3/4 Rnd - 15% 1/2 Cr	3/4" - #4 round	1/2" - #4 Crushed
A	MEASURE + AGGREGATE lb	70.76	70.90	70.12
B	EMPTY MEASURE lb	19.12	19.12	19.12
C	MASS OF AGGREGATE A-B lb	51.64	51.78	51.00
D	VOLUME OF MEASURE ft ³	0.5002	0.5002	0.5002
UNIT WEIGHT C / D lb/ft ³		103	104	102

SPECIFIC GRAVITY AND ABSORPTION OF COARSE AGGREGATE AASHTO T 85

SOURCE NAME		Best Rock	Best Rock	Best Rock
SOURCE NUMBER		12-123-3	12-123-3	12-123-3
MATERIAL SIZE		85% 3/4 Rnd - 15% 1/2" Cr	3/4" - #4 Round	1/2" - #4 Crushed
A	MASS OF DRY SAMPLE g	3059.6	3101.5	2235.1
B	MASS OF SSD SAMPLE g	3108.7	3145.6	2275.9
C	WEIGHT IN WATER g	1954.1	1985.4	1425.1
Gsb	A / (B - C)	2.650	2.673	2.627
Gsb ssd	B / (B - C)	2.692	2.711	2.675
Gsa	A / (A - C)	2.768	2.779	2.759
Absorption	[(B - A) / A] X 100	1.6	1.4	1.8

SPECIFIC GRAVITY AND ABSORPTION OF FINE AGGREGATE AASHTO T 84

PYCNOMETER METHOD				LeCHATelier FLASK METHOD			
SOURCE NAME		Best Rock		SOURCE NAME		Best Rock	
SOURCE NUMBER		12-123-3		SOURCE NUMBER		12-123-3	
MATERIAL SIZE		#4-0		MATERIAL SIZE		#4-0	
S	MASS OF SSD SAMPLE g	504.9		S₁	SSD MATERIAL IN FLASK (55±5) g	55.1	
A	MASS OF DRY SAMPLE g	485.6		S	SEPARATE SSD SAMPLE (500±10) g	504.9	
B	MASS OF PYC + WATER g	4298.0		R₁	INITIAL FLASK READING ml	0.3	
C	PYCN + WATER + SAMPLE g	4622.5		R₂	FINAL FLASK READING ml	20.0	
Gsb	A / (B + S - C)	2.692		A	MASS OF DRY SAMPLE g	485.6	
Gsb ssd	S / (B + S - C)	2.799		Gsb	[S ₁ (A / S) / [0.9975 (R ₂ - R ₁)]]	2.697	
Gsa	A / (B + A - C)	3.014		Gsb ssd	S ₁ / [0.9975 (R ₂ - R ₁)]]	2.804	
Absorption	[(S - A) / A] X 100	4.0		Absorption	[(S - A) / A] X 100	4.0	

CERTIFIED TECHNICIAN (PLEASE PRINT) AND CARD NUMBER Scott Aker #43048	COMPANY NAME ODOT Region 3 QA Unit	SIGNATURE	DATE 10/5/2017
---	--	-----------	--------------------------

BULK DENSITY "UNIT WEIGHT" MEASURE CALIBRATION

E

English (E) or Metric (M)

PROJECT NAME (SECTION)		CONTRACT NUMBER
CONTRACTOR OR SUPPLIER	PROJECT MANAGER	BID ITEM NUMBER

BULK DENSITY ("UNIT WEIGHT") AND VOIDS IN AGGREGATE AASHTO T 19

WATER DENSITY TABLE

°F	lb/ft³	°c	kg/m³	°F	lb/ft³	°c	kg/m³	°F	lb/ft³	°c	kg/m³
60.0	62.366	15.6	999.01	68.5	62.312	20.3	998.14	77.0	62.243	25.0	997.04
60.5	62.363	15.8	998.96	69.0	62.308	20.6	998.08	77.5	62.239	25.3	996.97
61.0	62.360	16.1	998.91	69.5	62.305	20.8	998.02	78.0	62.234	25.6	996.90
61.5	62.357	16.4	998.87	70.0	62.301	21.1	997.97	78.5	62.230	25.8	996.82
62.0	62.354	16.7	998.82	70.5	62.297	21.4	997.90	79.0	62.225	26.1	996.75
62.5	62.351	16.9	998.77	71.0	62.293	21.7	997.84	79.5	62.221	26.4	996.68
63.0	62.348	17.2	998.72	71.5	62.289	21.9	997.78	80.0	62.216	26.7	996.59
63.5	62.345	17.5	998.67	72.0	62.285	22.2	997.71	80.5	62.211	26.9	996.53
64.0	62.342	17.8	998.63	72.5	62.281	22.5	997.65	81.0	62.206	27.2	996.45
64.5	62.339	18.1	998.58	73.0	62.277	22.8	997.58	81.5	62.201	27.5	996.37
65.0	62.336	18.3	998.54	73.5	62.273	23.1	997.52	82.0	62.196	27.8	996.29
65.5	62.333	18.6	998.47	74.0	62.269	23.3	997.46	82.5	62.191	28.1	996.21
66.0	62.329	18.9	998.42	74.5	62.265	23.6	997.39	83.0	62.186	28.3	996.13
66.5	62.326	19.2	998.36	75.0	62.261	23.9	997.32	83.5	62.181	28.6	996.05
67.0	62.322	19.4	998.30	75.5	62.257	24.2	997.26	84.0	62.176	29.2	995.97
67.5	62.319	19.7	998.25	76.0	62.252	24.4	997.18	84.5	62.171	29.2	995.89
68.0	62.315	20.0	998.19	76.5	62.248	24.7	997.11	85.0	62.166	29.4	995.83

CALIBRATION OF MEASURE

RECALIBRATE ANNUALLY OR WHEN IN QUESTION

DATE					
SERIAL NUMBER					
1	MEASURE + GLASS + WATER	lb			
2	EMPTY MEASURE + GLASS	lb			
A	MASS OF WATER (1 - 2)	lb			
	TEMPERATURE OF WATER	°F			
B	DENSITY OF WATER	ft³			
V	VOLUME OF MEASURE (A / B)	ft³			

CERTIFIED TECHNICIAN (PLEASE PRINT) AND CARD NUMBER	COMPANY NAME	SIGNATURE	DATE
---	--------------	-----------	------

BULK DENSITY "UNIT WEIGHT" MEASURE CALIBRATION

E

English (E) or Metric (M)

PROJECT NAME (SECTION) Form Example		CONTRACT NUMBER 12345
CONTRACTOR OR SUPPLIER ODOT Forms	PROJECT MANAGER Sean Parker	BID ITEM NUMBER 123

BULK DENSITY ("UNIT WEIGHT") AND VOIDS IN AGGREGATE AASHTO T 19

WATER DENSITY TABLE											
°F	lb/ft ³	°c	kg/m ³	°F	lb/ft ³	°c	kg/m ³	°F	lb/ft ³	°c	kg/m ³
60.0	62.366	15.6	999.01	68.5	62.312	20.3	998.14	77.0	62.243	25.0	997.04
60.5	62.363	15.8	998.96	69.0	62.308	20.6	998.08	77.5	62.239	25.3	996.97
61.0	62.360	16.1	998.91	69.5	62.305	20.8	998.02	78.0	62.234	25.6	996.90
61.5	62.357	16.4	998.87	70.0	62.301	21.1	997.97	78.5	62.230	25.8	996.82
62.0	62.354	16.7	998.82	70.5	62.297	21.4	997.90	79.0	62.225	26.1	996.75
62.5	62.351	16.9	998.77	71.0	62.293	21.7	997.84	79.5	62.221	26.4	996.68
63.0	62.348	17.2	998.72	71.5	62.289	21.9	997.78	80.0	62.216	26.7	996.59
63.5	62.345	17.5	998.67	72.0	62.285	22.2	997.71	80.5	62.211	26.9	996.53
64.0	62.342	17.8	998.63	72.5	62.281	22.5	997.65	81.0	62.206	27.2	996.45
64.5	62.339	18.1	998.58	73.0	62.277	22.8	997.58	81.5	62.201	27.5	996.37
65.0	62.336	18.3	998.54	73.5	62.273	23.1	997.52	82.0	62.196	27.8	996.29
65.5	62.333	18.6	998.47	74.0	62.269	23.3	997.46	82.5	62.191	28.1	996.21
66.0	62.329	18.9	998.42	74.5	62.265	23.6	997.39	83.0	62.186	28.3	996.13
66.5	62.326	19.2	998.36	75.0	62.261	23.9	997.32	83.5	62.181	28.6	996.05
67.0	62.322	19.4	998.30	75.5	62.257	24.2	997.26	84.0	62.176	29.2	995.97
67.5	62.319	19.7	998.25	76.0	62.252	24.4	997.18	84.5	62.171	29.2	995.89
68.0	62.315	20.0	998.19	76.5	62.248	24.7	997.11	85.0	62.166	29.4	995.83

CALIBRATION OF MEASURE
RECALIBRATE ANNUALLY OR WHEN IN QUESTION

DATE		10/22/2007				
SERIAL NUMBER		R3QA-1				
1	MEASURE + GLASS + WATER	lb	53.18			
2	EMPTY MEASURE + GLASS	lb	22.02			
A	MASS OF WATER (1 - 2)	lb	31.16			
	TEMPERATURE OF WATER	°F	71.0			
B	DENSITY OF WATER	ft ³	62.293			
V	VOLUME OF MEASURE (A / B)	ft ³	0.5002			

CERTIFIED TECHNICIAN (PLEASE PRINT) AND CARD NUMBER Scott Aker #43048	COMPANY NAME ODOT Region 3 QA Unit	SIGNATURE	DATE 10/10/2012
---	--	-----------	---------------------------

RANDOM SAMPLE DENSITY LOCATIONS - ACP

E English (E) or Metric (M)

PROJECT NAME (SECTION)		CONTRACT NUMBER
CONTRACTOR OR SUPPLIER		PROJECT MANAGER
		BID ITEM NUMBER

AVG VOLUME 2000 (1000) <small>(MAMD x (% REQ'D / 100))</small>	$= \text{ft}^3/\text{ton}$ (m^3/Mg)	CROSS SECTION PANEL DEPTH 12 (1000)	\times PANEL WIDTH = ft^2 (m ²)	YIELD AVG VOLUME CROSS SEC.	$= \text{ft} / \text{ton}$ (m / Mg)	SUBLOT DIST. YIELD X SUBLOT SIZE	$= \text{ft}$ (m)
---	--	--	--	--	--	--	-------------------------------

MAMD	COMPACTION %	PANEL DEPTH in	PANEL WIDTH ft	AVG VOLUME ft ³ /ton	CROSS SEC. ft ²	YIELD (FT/TON) ft/ton	SUBLOT SIZE tons	SUBLOT DIST. ft
------	-----------------	-------------------	-------------------	------------------------------------	-------------------------------	--------------------------	---------------------	--------------------

TEST NUMBER	(A) THREE RANDOM DIGITS X .001	(B) SUBLOT SEGMENT DISTANCE OR TONS (Sublot Total / 5)	(C) BEGINNING STATION OR TONAGE	TEST LOCATION $C \pm (A \times B)$	(D) TWO RANDOM DIGITS X .01	(E) WIDTH MATERIAL COVERS ft.	OFFSET DIST. FROM RIGHT EDGE $((E - 2) \times D) + 1$

SUBLOT: DISTANCE	DISTANCE	TONS	AUTO-CALC.	RANDOMS	ASCENDING	DESCENDING
-------------------------	-----------------	------	-------------------	----------------	------------------	-------------------

MAMD	COMPACTION %	PANEL DEPTH in	PANEL WIDTH ft	AVG VOLUME ft ³ /ton	CROSS SEC. ft ²	YIELD (FT/TON) ft/ton	SUBLOT SIZE tons	SUBLOT DIST. ft
------	-----------------	-------------------	-------------------	------------------------------------	-------------------------------	--------------------------	---------------------	--------------------

TEST NUMBER	(A) THREE RANDOM DIGITS X .001	(B) SUBLOT SEGMENT DISTANCE OR TONS (Sublot Total / 5)	(C) BEGINNING STATION OR TONAGE	TEST LOCATION $C \pm (A \times B)$	(D) TWO RANDOM DIGITS X .01	(E) WIDTH MATERIAL COVERS ft.	OFFSET DIST. FROM RIGHT EDGE $((E - 2) \times D) + 1$

SUBLOT: DISTANCE	DISTANCE	TONS	AUTO-CALC.	RANDOMS	ASCENDING	DESCENDING
-------------------------	-----------------	------	-------------------	----------------	------------------	-------------------

MAMD	COMPACTION %	PANEL DEPTH in	PANEL WIDTH ft	AVG VOLUME ft ³ /ton	CROSS SEC. ft ²	YIELD (FT/TON) ft/ton	SUBLOT SIZE tons	SUBLOT DIST. ft
------	-----------------	-------------------	-------------------	------------------------------------	-------------------------------	--------------------------	---------------------	--------------------

TEST NUMBER	(A) THREE RANDOM DIGITS X .001	(B) SUBLOT SEGMENT DISTANCE OR TONS (Sublot Total / 5)	(C) BEGINNING STATION OR TONAGE	TEST LOCATION $C \pm (A \times B)$	(D) TWO RANDOM DIGITS X .01	(E) WIDTH MATERIAL COVERS ft.	OFFSET DIST. FROM RIGHT EDGE $((E - 2) \times D) + 1$

SUBLOT: DISTANCE	DISTANCE	TONS	AUTO-CALC.	RANDOMS	ASCENDING	DESCENDING
-------------------------	-----------------	------	-------------------	----------------	------------------	-------------------

MAMD	COMPACTION %	PANEL DEPTH in	PANEL WIDTH ft	AVG VOLUME ft ³ /ton	CROSS SEC. ft ²	YIELD (FT/TON) ft/ton	SUBLOT SIZE tons	SUBLOT DIST. ft
------	-----------------	-------------------	-------------------	------------------------------------	-------------------------------	--------------------------	---------------------	--------------------

TEST NUMBER	(A) THREE RANDOM DIGITS X .001	(B) SUBLOT SEGMENT DISTANCE OR TONS (Sublot Total / 5)	(C) BEGINNING STATION OR TONAGE	TEST LOCATION $C \pm (A \times B)$	(D) TWO RANDOM DIGITS X .01	(E) WIDTH MATERIAL COVERS ft.	OFFSET DIST. FROM RIGHT EDGE $((E - 2) \times D) + 1$

SUBLOT: DISTANCE	DISTANCE	TONS	AUTO-CALC.	RANDOMS	ASCENDING	DESCENDING
-------------------------	-----------------	------	-------------------	----------------	------------------	-------------------

CERTIFIED TECHNICIAN (PLEASE PRINT) AND CARD NUMBER	COMPANY NAME	SIGNATURE	DATE
---	--------------	-----------	------

RANDOM SAMPLE DENSITY LOCATIONS - ACP

E English (E) or Metric (M)

PROJECT NAME (SECTION) <p style="text-align: center;">Forms Example</p>		CONTRACT NUMBER <p style="text-align: center;">12345</p>
CONTRACTOR OR SUPPLIER <p style="text-align: center;">ODOT Forms</p>		PROJECT MANAGER <p style="text-align: center;">Sean Parker</p>
		BID ITEM NUMBER <p style="text-align: center;">123</p>

AVG VOLUME 2000 (1000) <small>(MAMD x (% REQ'D / 100))</small>	$= \text{ft}^3/\text{ton}$ (m^3/Mg)	CROSS SECTION PANEL DEPTH 12 (1000)	\times PANEL WIDTH = ft ² (m ²)	YIELD AVG VOLUME CROSS SEC.	$= \text{ft} / \text{ton}$ (m / Mg)	SUBLOT DIST. YIELD X SUBLOT SIZE = ft (m)
--	--	---	--	-----------------------------------	--	--

MAMD	COMPACTION	PANEL DEPTH	PANEL WIDTH	AVG VOLUME	CROSS SEC.	YIELD (FT/TON)	SUBLOT SIZE	SUBLOT DIST.
151.9	92.0 %	2 in	16 ft	14.32 ft ³ /ton	2.67 ft ²	5.36 ft/ton	1000 tons	5360 ft

TEST NUMBER	(A) THREE RANDOM DIGITS X .001	(B) SUBLOT SEGMENT DISTANCE OR TONS (Sublot Total / 5)	(C) BEGINNING STATION OR TONAGE	TEST LOCATION 772 C ± (A X B)	(D) TWO RANDOM DIGITS X .01	(E) WIDTH MATERIAL COVERS ft.	OFFSET DIST. FROM RIGHT EDGE ((E - 2) X D) + 1
1-1	0.254	1072	12345	12617	0.55	16.0	8.7
1-2	0.564	1072	13417	14022	0.96	16.0	14.4
1-3	0.854	1072	14489	15404	0.64	16.0	10.0
1-4	0.125	1072	15561	15695	0.08	16.0	2.1
1-5	0.025	1072	16633	16660	0.40	16.0	6.6

SUBLOT: DISTANCE	5360	DISTANCE	<input type="checkbox"/>	TONS	<input type="checkbox"/>	AUTO-CALC. RANDOMS	<input type="checkbox"/>	ASCENDING DESCENDING	<input type="checkbox"/>
------------------	------	----------	--------------------------	------	--------------------------	-----------------------	--------------------------	-------------------------	--------------------------

MAMD	COMPACTION	PANEL DEPTH	PANEL WIDTH	AVG VOLUME	CROSS SEC.	YIELD (FT/TON)	SUBLOT SIZE	SUBLOT DIST.
152.1	93.4 %	2 in	14 ft	14.07 ft ³ /ton	2.33 ft ²	6.04 ft/ton	1000 tons	6040 ft

TEST NUMBER	(A) THREE RANDOM DIGITS X .001	(B) SUBLOT SEGMENT DISTANCE OR TONS (Sublot Total / 5)	(C) BEGINNING STATION OR TONAGE	TEST LOCATION C ± (A X B)	(D) TWO RANDOM DIGITS X .01	(E) WIDTH MATERIAL COVERS ft.	OFFSET DIST. FROM RIGHT EDGE ((E - 2) X D) + 1
2-1	0.648	1208	12345	11562	0.46	14.0	6.5
2-2	0.522	1208	11137	10506	0.02	14.0	1.2
2-3	0.023	1208	9929	9901	0.18	14.0	3.2
2-4	0.089	1208	8721	8613	0.68	14.0	9.2
2-5	0.546	1208	7513	6853	0.93	14.0	12.2

SUBLOT: DISTANCE	6040	DISTANCE	<input type="checkbox"/>	TONS	<input type="checkbox"/>	AUTO-CALC. RANDOMS	<input type="checkbox"/>	ASCENDING DESCENDING	<input type="checkbox"/>
------------------	------	----------	--------------------------	------	--------------------------	-----------------------	--------------------------	-------------------------	--------------------------

MAMD	COMPACTION	PANEL DEPTH	PANEL WIDTH	AVG VOLUME	CROSS SEC.	YIELD (FT/TON)	SUBLOT SIZE	SUBLOT DIST.
152.2	92.6 %	2 in	16 ft	14.19 ft ³ /ton	2.67 ft ²	5.31 ft/ton	1000 tons	5310 ft

TEST NUMBER	(A) THREE RANDOM DIGITS X .001	(B) SUBLOT SEGMENT DISTANCE OR TONS (Sublot Total / 5)	(C) BEGINNING STATION OR TONAGE	TEST LOCATION C ± (A X B)	(D) TWO RANDOM DIGITS X .01	(E) WIDTH MATERIAL COVERS ft.	OFFSET DIST. FROM RIGHT EDGE ((E - 2) X D) + 1
3-1	0.365	200	2000	2073	0.03	16.0	1.4
3-2	0.215	200	2200	2243	0.09	16.0	2.3
3-3	0.025	200	2400	2405	0.55	16.0	8.7
3-4	0.005	200	2600	2601	0.87	16.0	13.2
3-5	0.859	200	2800	2972	0.46	16.0	7.4

SUBLOT: DISTANCE	1000	DISTANCE	<input type="checkbox"/>	TONS	<input type="checkbox"/>	AUTO-CALC. RANDOMS	<input type="checkbox"/>	ASCENDING DESCENDING	<input type="checkbox"/>
------------------	------	----------	--------------------------	------	--------------------------	-----------------------	--------------------------	-------------------------	--------------------------

MAMD	COMPACTION	PANEL DEPTH	PANEL WIDTH	AVG VOLUME	CROSS SEC.	YIELD (FT/TON)	SUBLOT SIZE	SUBLOT DIST.
152.4	91.5 %	3 in	14 ft	14.35 ft ³ /ton	3.5 ft ²	4.1 ft/ton	1000 tons	4100 ft

TEST NUMBER	(A) THREE RANDOM DIGITS X .001	(B) SUBLOT SEGMENT DISTANCE OR TONS (Sublot Total / 5)	(C) BEGINNING STATION OR TONAGE	TEST LOCATION C ± (A X B)	(D) TWO RANDOM DIGITS X .01	(E) WIDTH MATERIAL COVERS ft.	OFFSET DIST. FROM RIGHT EDGE ((E - 2) X D) + 1
4-1	0.879	200	3000	3176	0.56	14.0	7.7
4-2	0.556	200	3200	3311	0.88	14.0	11.6
4-3	0.989	200	3400	3598	0.16	14.0	2.9
4-4	0.521	200	3600	3704	0.09	14.0	2.1
4-5	0.014	200	3800	3803	0.07	14.0	1.8

SUBLOT: DISTANCE	1000	DISTANCE	<input type="checkbox"/>	TONS	<input type="checkbox"/>	AUTO-CALC. RANDOMS	<input type="checkbox"/>	ASCENDING DESCENDING	<input type="checkbox"/>
------------------	------	----------	--------------------------	------	--------------------------	-----------------------	--------------------------	-------------------------	--------------------------

CERTIFIED TECHNICIAN (PLEASE PRINT) AND CARD NUMBER <p style="text-align: center;">Scott Aker #43048</p>	COMPANY NAME <p style="text-align: center;">ODOT</p>	SIGNATURE	DATE <p style="text-align: center;">10/10/2012</p>
---	---	-----------	---

DAILY ASPHALT CEMENT REPORT

E English (E) or Metric (M)

PROJECT NAME (SECTION)						CONTRACT NUMBER	
CONTRACTOR				PROJECT MANAGER		REPORT NUMBER	
				SUPPLIER		DATE	
ASPHALT INVENTORY METHOD						SMALL QUANTITY METHOD	
PREVIOUS ENDING TANK STICK				LINE 8 FROM PREVIOUS REPORT		1	
DELIVERIES BEFORE BEGINNING TANK STICK				Tons MIX THIS DATE		X $\frac{C}{100} =$ ASPHALT CEMENT INCORPORATED	
INVOICE NO.	Tons	INVOICE NO.	Tons	INVOICE NO.	Tons	10	
TOTAL DELIVERIES						2	
DEDUCTIONS BEFORE BEGINNING INVENTORY EXPLAIN BELOW OR ON ATTACHMENT							
EXPLANATION				3		ASPHALT CEMENT INCORPORATED 11	
BEGINNING INVENTORY 1 + 2 - 3 (ANY DIFFERENCES WITH LINE 5 OTHER THAN MINOR MEASURING DIFFERENCES, MUST BE RESOLVED)						4	
BEGINNING TANK STICK						ASPHALT CEMENT SUMMARY	
TANK NO.	TEMP	TANK STICK	VOLUME IN TANK X	TEMP. CORR. FACTOR X	SPECIFIC GRAVITY /239.9=Tons	PREVIOUS REPORT LINE 14 12	
1						THIS REPORT LINE 9, 10, OR 11 13	
2						ASPHALT CEMENT IN MIXTURE TO DATE 12 + 13 14	
3							
BEGINNING TANK STICK TOTAL						5	
DELIVERIES AFTER BEGINNING INVENTORY						ASPHALT MIXTURE SUMMARY	
INVOICE NO.	Tons	INVOICE NO.	Tons	INVOICE NO.	Tons	CLASS _____ B.I. NO.	
						HMAC	
						PREVIOUS REPORT LINE 17 15	
						MATERIAL RECEIPT TOTAL FOR THIS DATE 16	
TOTAL DELIVERIES						6	
DEDUCTIONS AFTER BEGINNING INVENTORY (TACK, WASTE, REJECT, SOLD TO OTHERS ETC.) EXPLAIN BELOW OR ON ATTACHMENT						7	
ENDING TANK STICK						ASPHALT MIXTURE SUMMARY	
TANK NO.	TEMP	TANK STICK	VOLUME IN TANK X	TEMP. CORR. FACTOR X	SPECIFIC GRAVITY /239.9=Tons	PREVIOUS REPORT LINE 20 18	
1						MATERIAL RECEIPT TOTAL FOR THIS DATE 19	
2						ASPHALT MIXTURE TO DATE 18+19 20	
3							
ENDING TANK STICK TOTAL						8	
ASPHALT CEMENT LINES 4 or 5 + 6 - 7 - 8						9	
WASTE DEDUCTION CALCULATION From Form 2401						Remarks	
TOTAL MIX NOT ACCEPTED Line "e" e							
DAILY AVERAGE MIX MOISTURE Line "g" g							
TOTAL DRY MIX NOT ACCEPTED $e / (1+(g/100))$ TD							
BY TANK % Pb HMAC Line "Z" Z							
WASTE ASPHALT for line 7 deductions $(TD \times Z) / 100$ 7							
CERTIFIED TECHNICAN (PLEASE PRINT) AND CARD NUMBER				COMPANY NAME		SIGNATURE	
						DATE	

DAILY ASPHALT CEMENT REPORT

E English (E) or Metric (M)

PROJECT NAME (SECTION) <p style="text-align: center;">Forms Example</p>						CONTRACT NUMBER <p style="text-align: center;">12345</p>	
CONTRACTOR <p style="text-align: center;">ODOT Forms</p>				PROJECT MANAGER <p style="text-align: center;">Sean Parker</p>		REPORT NUMBER <p style="text-align: center;">123</p>	
SUPPLIER <p style="text-align: center;">Confidential</p>						DATE <p style="text-align: center;">10/10/2012</p>	
ASPHALT INVENTORY METHOD						SMALL QUANTITY METHOD	
PREVIOUS ENDING TANK STICK <p style="text-align: center;">LINE 8 FROM PREVIOUS REPORT</p>				1 95.94		ASPHALT TARGET % FROM JOB MIX FORMULA <p style="text-align: center;">C</p>	
DELIVERIES BEFORE BEGINNING TANK STICK						Tons MIX THIS DATE X $\frac{C}{100} =$ ASPHALT CEMENT INCORPORATED	
INVOICE NO.	Tons	INVOICE NO.	Tons	INVOICE NO.	Tons	0 10	
TOTAL DELIVERIES						BATCH MASS METHOD	
DEDUCTIONS BEFORE BEGINNING INVENTORY EXPLAIN BELOW OR ON ATTACHMENT						BATCH TICKET NO.	
EXPLANATION						ASPHALT CEMENT INCORPORATED	
3 0.09						11	
BEGINNING INVENTORY 1 + 2 - 3 (ANY DIFFERENCES WITH LINE 5 OTHER THAN MINOR MEASURING DIFFERENCES, MUST BE RESOLVED)						ASPHALT CEMENT SUMMARY	
4 95.85						ASPHALT CEMENT IN MIX B.I. NO. <p style="text-align: center;">123</p>	
BEGINNING TANK STICK						PREVIOUS REPORT LINE 14 12 531.66	
TANK NO.	TEMP	TANK STICK	VOLUME IN TANK X	TEMP. CORR. FACTOR X	SPECIFIC GRAVITY /239.9=Tons	THIS REPORT LINE 9, 10, OR 11 13 147.23	
1	320	27.5"	24699	0.9118	1.021	ASPHALT CEMENT IN MIXTURE TO DATE 12 + 13 14 678.89	
2							
3							
BEGINNING TANK STICK TOTAL						ASPHALT MIXTURE SUMMARY	
5 95.85						CLASS B.I. NO. <p style="text-align: center;">HMAC 124</p>	
DELIVERIES AFTER BEGINNING INVENTORY						PREVIOUS REPORT LINE 17 15 10006.45	
INVOICE NO.	Tons	INVOICE NO.	Tons	INVOICE NO.	Tons	MATERIAL RECEIPT TOTAL FOR THIS DATE 16 2735.78	
V09586	24.95	V09589	24.40			ASPHALT MIXTURE TO DATE 15+16 17 12742.23	
V09587	23.51	V09590	23.49				
V09588	23.66						
TOTAL DELIVERIES						CLASS	
DEDUCTIONS AFTER BEGINNING INVENTORY (TACK, WASTE, REJECT, SOLD TO OTHERS ETC.) EXPLAIN BELOW OR ON ATTACHMENT						B.I. NO.	
7 0.27						HMAC	
ENDING TANK STICK						PREVIOUS REPORT LINE 20 18	
TANK NO.	TEMP	TANK STICK	VOLUME IN TANK X	TEMP. CORR. FACTOR X	SPECIFIC GRAVITY /239.9=Tons	MATERIAL RECEIPT TOTAL FOR THIS DATE 19	
1	325	49.25"	17648	0.9101	1.021	ASPHALT MIXTURE TO DATE 18+19 20	
2							
3							
ENDING TANK STICK TOTAL						ASPHALT CEMENT	
8 68.36						LINES 4 or 5 + 6 - 7 - 8	
9 147.23							
WASTE DEDUCTION CALCULATION						EXPLANATION	
From Form 2401							
TOTAL MIX NOT ACCEPTED Line "e" e 5.00							
DAILY AVERAGE MIX MOISTURE Line "g" g 0.27							
TOTAL DRY MIX NOT ACCEPTED e / (1+(g/100)) TD 4.99							
BY TANK % Pb HMAC Line "Z" Z 5.40							
WASTE ASPHALT for line 7 deductions (TDxZ)/100 7 0.27							
CERTIFIED TECHNICAN (PLEASE PRINT) AND CARD NUMBER				COMPANY NAME		SIGNATURE	
Scott Aker #43048				ODOT		DATE <p style="text-align: center;">10/10/2012</p>	

SPECIFIC GRAVITY AND MAXIMUM DENSITY OF ACP E English (E) or Metric(M)

PROJECT NAME (SECTION)				CONTRACT NUMBER	
CONTRACTOR OR SUPPLIER			PROJECT MANAGER		BID ITEM NUMBER
ODOT MIX DESIGN NO.	JMF MAX SPECIFIC GRAVITY		PYCNOMETER		MIX NOMINAL SIZE

		DATE	DATE	DATE	DATE	DATE
		TIME	TIME	TIME	TIME	TIME
		LOT & SUBLOT	LOT & SUBLOT	LOT & SUBLOT	LOT & SUBLOT	LOT & SUBLOT
1	PYCNOMETER + LID + MIX					
2	PYCNOMETER + LID					
A	MASS OF DRY SAMPLE (1 - 2)					
A _{SSD}	MASS OF SSD SAMPLE (uncoated porous agg.)					
D	PYCNOMETER + LID + WATER					
E	PYCNOMETER + LID + WATER + MIX					
G	$G_{mm} (pre) = A / (A + D - E)$					
H	$G_{mm SSD} = A / (A_{SSD} + D - E)$ (uncoated porous agg.)					
I	MAX DENSITY = G or H x 62.4					
J	THE PREVIOUS MAMD					
K	THE DIFFERENCE BETWEEN I & J					
THE MOVING AVERAGE MAXIMUM DENSITY (MAMD)						

THE MOVING AVERAGE MAXIMUM DENSITY (MAMD)																	
<table border="1" style="width: 100%; border-collapse: collapse;"> <tr> <th colspan="2">MDT'S Previous Form</th> </tr> <tr> <th>TEST NO</th> <th>MDT</th> </tr> <tr><td> </td><td> </td></tr> <tr><td> </td><td> </td></tr> <tr><td> </td><td> </td></tr> <tr><td> </td><td> </td></tr> <tr><td> </td><td> </td></tr> <tr><td> </td><td> </td></tr> </table>	MDT'S Previous Form		TEST NO	MDT													REMARKS
MDT'S Previous Form																	
TEST NO	MDT																

QUALITY CONTROL	VERIFICATION	INDEPENDENT ASSURANCE
CERTIFIED TECHNICIAN (PLEASE PRINT) AND CARD NUMBER	COMPANY NAME	SIGNATURE DATE

SPECIFIC GRAVITY AND MAXIMUM DENSITY OF ACP E English (E) or Metric(M)

PROJECT NAME (SECTION) Form Example				CONTRACT NUMBER 12345	
CONTRACTOR OR SUPPLIER ODOT Forms			PROJECT MANAGER Sean Parker		BID ITEM NUMBER 123
ODOT MIX DESIGN NO. 10-MD0001	JMF MAX SPECIFIC GRAVITY 2.556		PYCNOMETER 1122		MIX NOMINAL SIZE L3 1/2" Dense

		DATE 10/18/12	DATE 10/19/12	DATE 10/20/12	DATE 10/21/12	DATE 10/22/12
		TIME 6:00am	TIME 6:30am	TIME 7:30am	TIME 6:00am	TIME 8:00am
		LOT & SUBLOT 1-10	LOT & SUBLOT 1-11	LOT & SUBLOT 1-12	LOT & SUBLOT 1-13	LOT & SUBLOT 1-14
1	PYCNOMETER + LID + MIX	4621.3	4715.7	4599.5	4682.3	4542.2
2	PYCNOMETER + LID	2924.4	2924.4	2924.4	2924.4	2924.4
A	MASS OF DRY SAMPLE (1 - 2)	1696.9	1791.3	1675.1	1757.9	1617.8
A _{SSD}	MASS OF SSD SAMPLE (uncoated porous agg.)					
D	PYCNOMETER + LID + WATER	7327.8	7327.8	7327.8	7327.8	7327.8
E	PYCNOMETER + LID + WATER + MIX	8369.0	8421.3	8354.3	8399.9	8319.2
G	Gmm (pre) = A / (A + D - E)	2.588	2.567	2.583	2.563	2.583
H	Gmm _{SSD} = A / (A _{SSD} + D - E) (uncoated porous agg.)					
I	MAX DENSITY = G or H x 62.4	161.5	160.2	161.2	159.9	161.2
J	THE PREVIOUS MAMD	160.8	160.6	160.7	160.6	160.4
K	THE DIFFERENCE BETWEEN I & J	0.7	-0.4	0.5	-0.7	0.8
THE MOVING AVERAGE MAXIMUM DENSITY (MAMD)		160.6	160.7	160.6	160.4	160.8

MDT'S Previous Form		REMARKS
TEST NO	MDT	
1-5	162.6	
1-6	159.9	
1-7	161.4	
1-8	160.9	
1-9	159.4	

<input checked="" type="checkbox"/> QUALITY CONTROL	<input type="checkbox"/> VERIFICATION	<input type="checkbox"/> INDEPENDENT ASSURANCE	
CERTIFIED TECHNICIAN (PLEASE PRINT) AND CARD NUMBER Scott Aker #43048	COMPANY NAME ODOT	SIGNATURE	DATE 10/22/2012

VOIDS WORKSHEET GYRATORY

E English (E) or Metric (M)

PROJECT NAME (SECTION)												CONTRACT NUMBER			
CONTRACTOR OR SUPPLIER							PROJECT MANAGER					BID ITEM NUMBER			
ODOT MIX DESIGN NO.	DESIGN Gsb		DESIGN Gmm		DESIGN VMA		DESIGN Va		DESIGN Pb		MATERIAL TYPE				
COMPACTOR MAKE	SERIAL NUMBER		AC BRAND		AC GRADE		AC Gb @ 77°F		NUMBER GYRATIONS		PLACEMENT TEMP RANGE				
												RUNNING AVERAGE			
DATE	Test Pb	Test P75um	Gse	Pba	Pbe	P75um/Pbe	Va	VMA	VFA	P75um/Pbe	Va	VMA	VFA		
TEST	Test №		Gmb						PYCNOMETER + LID + MIX						
	specimen height	COMPACTED Temperature	(A) MASS IN AIR	(C) MASS IN WATER	(B) MASS SSD	<u>A</u> B-C		PYCNOMETER + LID							
								MASS OF DRY SAMPLE (A)							
								MASS OF SSD SAMPLE (A _{SSD})							
								PYCNOMETER + LID+H2O							
REMARKS: TIME SAMPLED:							TIME COMPACTED:		AVE		PYCNOMETER+ LID+H2O+MIX				
												Gmm _{SSD}		Gmm	
												RUNNING AVERAGE			
DATE	Test Pb	Test P75um	Gse	Pba	Pbe	P75um/Pbe	Va	VMA	VFA	P75um/Pbe	Va	VMA	VFA		
TEST	Test №		Gmb						PYCNOMETER + LID + MIX						
	specimen height	COMPACTED Temperature	(A) MASS IN AIR	(C) MASS IN WATER	(B) MASS SSD	<u>A</u> B-C		PYCNOMETER + LID							
								MASS OF DRY SAMPLE (A)							
								MASS OF SSD SAMPLE (A _{SSD})							
								PYCNOMETER + LID+H2O							
REMARKS: TIME SAMPLED:							TIME COMPACTED:		AVE		PYCNOMETER+ LID+H2O+MIX				
												Gmm _{SSD}		Gmm	
												RUNNING AVERAGE			
DATE	Test Pb	Test P75um	Gse	Pba	Pbe	P75um/Pbe	Va	VMA	VFA	P75um/Pbe	Va	VMA	VFA		
TEST	Test №		Gmb						PYCNOMETER + LID + MIX						
	specimen height	COMPACTED Temperature	(A) MASS IN AIR	(C) MASS IN WATER	(B) MASS SSD	<u>A</u> B-C		PYCNOMETER + LID							
								MASS OF DRY SAMPLE (A)							
								MASS OF SSD SAMPLE (A _{SSD})							
								PYCNOMETER + LID+H2O							
REMARKS: TIME SAMPLED:							TIME COMPACTED:		AVE		PYCNOMETER+ LID+H2O+MIX				
												Gmm _{SSD}		Gmm	
												RUNNING AVERAGE			
DATE	Test Pb	Test P75um	Gse	Pba	Pbe	P75um/Pbe	Va	VMA	VFA	P75um/Pbe	Va	VMA	VFA		
TEST	Test №		Gmb						PYCNOMETER + LID + MIX						
	specimen height	COMPACTED Temperature	(A) MASS IN AIR	(C) MASS IN WATER	(B) MASS SSD	<u>A</u> B-C		PYCNOMETER + LID							
								MASS OF DRY SAMPLE (A)							
								MASS OF SSD SAMPLE (A _{SSD})							
								PYCNOMETER + LID+H2O							
REMARKS: TIME SAMPLED:							TIME COMPACTED:		AVE		PYCNOMETER+ LID+H2O+MIX				
												Gmm _{SSD}		Gmm	
												RUNNING AVERAGE			

Previous Forms Results					Dryback Trigger						
Test №	P75um/Pbe	Va	VMA	VFA	Test No.	A	A _{SSD}	% Diff	Avg Diff	Dryback Requirement	
										Gmm	
										Gmm _{SSD}	

Quality Control		Verification				
CERTIFIED TECHNICIAN (PLEASE PRINT) AND CARD NUMBER				COMPANY NAME	SIGNATURE	DATE

VOIDS WORKSHEET GYRATORY

E English (E) or Metric (M)

PROJECT NAME (SECTION) Forms Sample										CONTRACT NUMBER 12345							
CONTRACTOR OR SUPPLIER ODOT Forms					PROJECT MANAGER Sean Parker					BID ITEM NUMBER 123							
ODOT MIX DESIGN NO. 17-MD0001	DESIGN Gsb 2.724	DESIGN Gmm 2.556	DESIGN VMA 14.8	DESIGN Va 4.4	DESIGN Pb 5.30%	MATERIAL TYPE L4 1/2" ACP											
COMPACTOR MAKE Brovold	SERIAL NUMBER 59902	AC BRAND Albina	AC GRADE 70-22ER	AC Gb @ 77°F 1.039	NUMBER GYRATIONS 100	PLACEMENT TEMP RANGE 311-321											
RUNNING AVERAGE																	
DATE 12/11/17	Test Pb 5.36	Test P75um 5.3	Gse	Pba	Pbe	P75um/Pbe	Va	VMA 15.8	VFA	P75um/Pbe	Va	VMA	VFA				
TEST	Test №	Gmb					PYCNOMETER + LID + MIX			5599.6							
	specimen	COMPACTED	(A) MASS IN	(C) MASS IN	(B) MASS	<u>A</u>	PYCNOMETER + LID			2924.4							
	height	Temperature	AIR	WATER	SSD	B-C	MASS OF DRY SAMPLE (A)			2675.2							
	1	115.2	295	4828.3	2847.4	4831.0	2.434	MASS OF SSD SAMPLE (A _{SSD})			2676.8						
	2	115.2	293	4840.5	2840.4	4847.4	2.412	PYCNOMETER + LID+H2O			7327.8						
REMARKS: TIME SAMPLED: 7:00 TIME COMPACTED: 8:30 AVE							2.423	PYCNOMETER+ LID+H2O+MIX			8962.8						
Gmm _{SSD}										Gmm							
RUNNING AVERAGE																	
DATE 12/12/17	Test Pb 5.42	Test P75um 5.1	Gse	Pba	Pbe	P75um/Pbe	Va	VMA 14.6	VFA	P75um/Pbe	Va	VMA	VFA				
TEST	Test №	Gmb					PYCNOMETER + LID + MIX			5579.6							
	specimen	COMPACTED	(A) MASS IN	(C) MASS IN	(B) MASS	<u>A</u>	PYCNOMETER + LID			2924.4							
	height	Temperature	AIR	WATER	SSD	B-C	MASS OF DRY SAMPLE (A)			2655.2							
	1	115.9	296	4832.3	2878.6	4842.8	2.460	MASS OF SSD SAMPLE (A _{SSD})			2656.8						
	2	116.2	296	4822.1	2873.1	4831.9	2.462	PYCNOMETER + LID+H2O			7327.8						
REMARKS: TIME SAMPLED: 11:00 TIME COMPACTED: 12:30 AVE							2.461	PYCNOMETER+ LID+H2O+MIX			8953.1						
Gmm _{SSD}										Gmm							
RUNNING AVERAGE																	
DATE 12/13/17	Test Pb 5.33	Test P75um 5.8	Gse	Pba	Pbe	P75um/Pbe	Va	VMA 15.2	VFA	P75um/Pbe	Va	VMA	VFA				
TEST	Test №	Gmb					PYCNOMETER + LID + MIX			5049.8							
	specimen	COMPACTED	(A) MASS IN	(C) MASS IN	(B) MASS	<u>A</u>	PYCNOMETER + LID			2924.4							
	height	Temperature	AIR	WATER	SSD	B-C	MASS OF DRY SAMPLE (A)			2125.4							
	1	115	292	4840.5	2860.4	4847.4	2.436	MASS OF SSD SAMPLE (A _{SSD})			2127.0						
	2	114.4	294	4828.3	2857.4	4831.0	2.446	PYCNOMETER + LID+H2O			7327.8						
REMARKS: TIME SAMPLED: 3:00 TIME COMPACTED: 4:45 AVE							2.441	PYCNOMETER+ LID+H2O+MIX			8625.8						
Gmm _{SSD}										Gmm							
Previous Forms Results										Dryback Trigger							
Test №	P75um/Pbe	Va	VMA	VFA					Dryback Requirement								
1-1	1.45	6.0	17.0	72	Test No.	A	A _{SSD}	% Diff	Avg Diff								
1-2	1.19	3.8	15.0	69	Info	1753.2	1754.8	0.09%		Gmm							
1-3	1.70	4.0	14.7	65						Gmm _{SSD}							
Quality Control		Verification															
CERTIFIED TECHNICIAN (PLEASE PRINT) AND CARD NUMBER					COMPANY NAME					SIGNATURE				DATE			
Nathaniel Powell #44595					ODOT									12/13/2017			

VOIDS WORKSHEET GYRATORY

E English (E) or Metric (M)

PROJECT NAME (SECTION) Forms Sample											CONTRACT NUMBER 12345					
CONTRACTOR OR SUPPLIER ODOT Forms							PROJECT MANAGER Sean Parker				BID ITEM NUMBER 123					
ODOT MIX DESIGN NO. 17-MD0001	DESIGN Gsb 2.724	DESIGN Gmm 2.556	DESIGN VMA 14.8	DESIGN Va 4.4	DESIGN Pb 5.30%	MATERIAL TYPE L4 1/2" ACP										
COMPACTOR MAKE Brovold	SERIAL NUMBER 59902	AC BRAND Albina	AC GRADE 70-22ER	AC Gb @ 77°F 1.039	NUMBER GYRATIONS 100	PLACEMENT TEMP RANGE 311-321										
RUNNING AVERAGE																
DATE 12/11/17	Test Pb 5.36	Test P75um 5.3	Gse 2.807	Pba 1.13	Pbe 4.29	P75um/Pbe 1.24	Va 5.8	VMA 15.8	VFA 63	P75um/Pbe 1.4	Va 4.9	VMA 15.6	VFA 67			
TEST	Test № 1-4	Gmb					PYCNOMETER + LID + MIX				5599.6					
	specimen height	COMPACTED Temperature	(A) MASS IN AIR	(C) MASS IN WATER	(B) MASS SSD	<u>A</u> B-C	PYCNOMETER + LID				2924.4					
							MASS OF DRY SAMPLE (A)				2675.2					
	1	115.2	295	4828.3	2847.4	4831.0	2.434	MASS OF SSD SAMPLE (A _{SSD})				2676.8				
	2	115.2	293	4840.5	2840.4	4847.4	2.412	PYCNOMETER + LID+H2O				7327.8				
REMARKS: TIME SAMPLED: 7:00 TIME COMPACTED: 8:30 AVE							2.423	PYCNOMETER+ LID+H2O+MIX				8962.8				
											Gmm _{SSD}		Gmm		2.572	
RUNNING AVERAGE																
DATE 12/12/17	Test Pb 5.42	Test P75um 5.1	Gse 2.817	Pba 1.26	Pbe 4.23	P75um/Pbe 1.21	Va 4.5	VMA 14.6	VFA 69	P75um/Pbe 1.3	Va 4.5	VMA 15.0	VFA 67			
TEST	Test № 1-5	Gmb					PYCNOMETER + LID + MIX				5579.6					
	specimen height	COMPACTED Temperature	(A) MASS IN AIR	(C) MASS IN WATER	(B) MASS SSD	<u>A</u> B-C	PYCNOMETER + LID				2924.4					
							MASS OF DRY SAMPLE (A)				2655.2					
	1	115.9	296	4832.3	2878.6	4842.8	2.460	MASS OF SSD SAMPLE (A _{SSD})				2656.8				
	2	116.2	296	4822.1	2873.1	4831.9	2.462	PYCNOMETER + LID+H2O				7327.8				
REMARKS: TIME SAMPLED: 11:00 TIME COMPACTED: 12:30 AVE							2.461	PYCNOMETER+ LID+H2O+MIX				8953.1				
											Gmm _{SSD}		Gmm		2.578	
RUNNING AVERAGE																
DATE 12/13/17	Test Pb 5.33	Test P75um 5.8	Gse 2.801	Pba 1.05	Pbe 4.34	P75um/Pbe 1.34	Va 5.0	VMA 15.2	VFA 67	P75um/Pbe 1.4	Va 4.8	VMA 15.1	VFA 66			
TEST	Test № 1-5	Gmb					PYCNOMETER + LID + MIX				5049.8					
	specimen height	COMPACTED Temperature	(A) MASS IN AIR	(C) MASS IN WATER	(B) MASS SSD	<u>A</u> B-C	PYCNOMETER + LID				2924.4					
							MASS OF DRY SAMPLE (A)				2125.4					
	1	115	292	4840.5	2860.4	4847.4	2.436	MASS OF SSD SAMPLE (A _{SSD})				2127.0				
	2	114.4	294	4828.3	2857.4	4831.0	2.446	PYCNOMETER + LID+H2O				7327.8				
REMARKS: TIME SAMPLED: 3:00 TIME COMPACTED: 4:45 AVE							2.441	PYCNOMETER+ LID+H2O+MIX				8625.8				
											Gmm _{SSD}		Gmm		2.569	
Previous Forms Results											Dryback Trigger					
Test №	P75um/Pbe	Va	VMA	VFA	Dryback Requirement											
1-1	1.45	6.0	17.0	72	Test No.	A	A _{SSD}	% Diff	Avg Diff	Gmm <input checked="" type="checkbox"/> Gmm _{SSD}						
1-2	1.19	3.8	15.0	69	Info	1753.2	1754.8	0.09%								
1-3	1.70	4.0	14.7	65	SU	1753.2	1757.6	0.25%	0.17%							
Quality Control		Verification														
CERTIFIED TECHNICIAN (PLEASE PRINT) AND CARD NUMBER							COMPANY NAME			SIGNATURE		DATE				
Nathaniel Powell #44595							ODOT					12/13/2017				

VOIDS WORKSHEET GYRATORY

E English (E) or Metric (M)

PROJECT NAME (SECTION) Forms Sample											CONTRACT NUMBER 12345					
CONTRACTOR OR SUPPLIER ODOT Forms							PROJECT MANAGER Sean Parker				BID ITEM NUMBER 123					
ODOT MIX DESIGN NO. 17-MD0001		DESIGN Gsb 2.724		DESIGN Gmm 2.556		DESIGN VMA 14.8		DESIGN Va 4.4		DESIGN Pb 5.30%		MATERIAL TYPE L4 1/2" ACP				
COMPACTOR MAKE Brovold		SERIAL NUMBER 59902		AC BRAND Albina		AC GRADE 70-22ER		AC Gb @ 77°F 1.039		NUMBER GYRATIONS 100		PLACEMENT TEMP RANGE 311-321				
											RUNNING AVERAGE					
DATE	Test Pb	Test P75um	Gse	Pba	Pbe	P75um/Pbe	Va	VMA	VFA	P75um/Pbe	Va	VMA	VFA			
12/11/17	5.36	5.3	2.801	1.05	4.37	1.21	5.6	15.8	65	1.4	4.9	15.6	68			
TEST	Test № 1-4		Gmb						PYCNOMETER + LID + MIX		5599.6					
	specimen	COMPACTED	(A) MASS IN	(C) MASS IN	(B) MASS	<u>A</u>		PYCNOMETER + LID		2924.4						
	height	Temperature	AIR	WATER	SSD	B-C		MASS OF DRY SAMPLE (A)		2675.2						
	1	115.2	295	4828.3	2847.4	4831.0	2.434		MASS OF SSD SAMPLE (A _{SSD})		2676.8					
	2	115.2	293	4840.5	2840.4	4847.4	2.412		PYCNOMETER + LID+H2O		7327.8					
REMARKS: TIME SAMPLED: 7:00 TIME COMPACTED: 8:30 AVE							2.423		PYCNOMETER+ LID+H2O+MIX		8962.8					
											Gmm _{SSD} 2.568		Gmm			
											RUNNING AVERAGE					
DATE	Test Pb	Test P75um	Gse	Pba	Pbe	P75um/Pbe	Va	VMA	VFA	P75um/Pbe	Va	VMA	VFA			
12/12/17	5.42	5.1	2.812	1.19	4.29	1.19	4.4	14.6	70	1.3	4.5	15.0	67			
TEST	Test № 1-5		Gmb						PYCNOMETER + LID + MIX		5579.6					
	specimen	COMPACTED	(A) MASS IN	(C) MASS IN	(B) MASS	<u>A</u>		PYCNOMETER + LID		2924.4						
	height	Temperature	AIR	WATER	SSD	B-C		MASS OF DRY SAMPLE (A)		2655.2						
	1	115.9	296	4832.3	2878.6	4842.8	2.460		MASS OF SSD SAMPLE (A _{SSD})		2656.8					
	2	116.2	296	4822.1	2873.1	4831.9	2.462		PYCNOMETER + LID+H2O		7327.8					
REMARKS: TIME SAMPLED: 11:00 TIME COMPACTED: 12:30 AVE							2.461		PYCNOMETER+ LID+H2O+MIX		8953.1					
											Gmm _{SSD} 2.574		Gmm			
											RUNNING AVERAGE					
DATE	Test Pb	Test P75um	Gse	Pba	Pbe	P75um/Pbe	Va	VMA	VFA	P75um/Pbe	Va	VMA	VFA			
12/13/17	5.33	5.8	2.795	0.97	4.41	1.32	4.8	15.2	68	1.4	4.7	15.1	67			
TEST	Test № 1-5		Gmb						PYCNOMETER + LID + MIX		5049.8					
	specimen	COMPACTED	(A) MASS IN	(C) MASS IN	(B) MASS	<u>A</u>		PYCNOMETER + LID		2924.4						
	height	Temperature	AIR	WATER	SSD	B-C		MASS OF DRY SAMPLE (A)		2125.4						
	1	115	292	4840.5	2860.4	4847.4	2.436		MASS OF SSD SAMPLE (A _{SSD})		2127.0					
	2	114.4	294	4828.3	2857.4	4831.0	2.446		PYCNOMETER + LID+H2O		7327.8					
REMARKS: TIME SAMPLED: 3:00 TIME COMPACTED: 4:45 AVE							2.441		PYCNOMETER+ LID+H2O+MIX		8625.8					
											Gmm _{SSD} 2.564		Gmm			
											RUNNING AVERAGE					
Previous Forms Results					Dryback Trigger											
Test №	P75um/Pbe	Va	VMA	VFA					Dryback Requirement							
1-1	1.45	6.0	17.0	72	Test No.	A	A _{SSD}	% Diff	Avg Diff							
1-2	1.19	3.8	15.0	69	Info	1753.2	1754.8	0.09%		Gmm						
1-3	1.70	4.0	14.7	65	SU	1753.2	1760.0	0.39%	0.24%	Gmm _{SSD}	X					
Quality Control		Verification														
CERTIFIED TECHNICIAN (PLEASE PRINT) AND CARD NUMBER					COMPANY NAME				SIGNATURE				DATE			
Nathaniel Powell #44595					ODOT								12/13/2017			

VOIDS WORKSHEET GYRATORY

E English (E) or Metric (M)

PROJECT NAME (SECTION)						CONTRACT NUMBER
CONTRACTOR OR SUPPLIER				PROJECT MANAGER		BID ITEM NUMBER
DOT MIX DESIGN NO.	DESIGN Gsb	DESIGN Gmm	DESIGN VMA	DESIGN Va	DESIGN Pb	MATERIAL TYPE
COMPACTOR MAKE	SERIAL NUMBER	AC BRAND	AC GRADE	AC Gb @ 60°F	NUMBER GYRATIONS	PLACEMENT TEMP RANGE
DATE						
TIME SAMPLED		TIME COMPACTED			LOT & SUBLOT	

AASHTO T 166			AASHTO T 209		
	SPECIMEN ID		1	PYCNOMETER + LID + MIX	
	SPECIMEN HEIGHT		2	PYCNOMETER + LID	
	COMPACTED TEMP.		A	MASS OF DRY SAMPLE (1 - 2)	
A	MASS IN AIR		A _{SSD}	MASS OF SSD SAMPLE (uncoated porous agg.)	
C	MASS IN WATER		D	PYCNOMETER + LID + WATER	
B	MASS SSD		E	PYCNOMETER + LID + WATER + MIX	
Gmb	A / (B - C)		G	Gmm (pre) = A / (A + D - E)	
AVE	Gmb		H	Gmm _{SSD} = A / (A _{SSD} + D - E) (uncoated porous agg.)	

<p>Va</p> $= \left(\frac{Gmm - Gmb}{Gmm} \right) \times 100$	<p>Pb</p> <p>Gb 77°F</p> <p>Gsb</p> <p>P #200</p>	<p>Ps 100 - Pb</p> <p>= 100 -</p> <hr/> <p>Gse</p> $= \frac{Ps}{\frac{100}{Gmm} - \frac{Pb}{Gb}}$ <hr/> <p>Pba</p> $= 100 \times \frac{(Gse - Gsb)}{(Gsb \times Gse)} \times Gb$ <hr/> <p>Pbe</p> $= Pb - \left(\left[\frac{Pba}{100} \right] \times Ps \right)$
<p>VMA</p> $= 100 - \left(\frac{Gmb \times PS}{Gsb} \right)$		
<p>VFA</p> $= \frac{(VMA - Va)}{VMA} \times 100$		
<p>P #200/Pbe</p> <p>= /</p>		

Previous Results					Dryback Trigger					
Test No	Va	VMA	VFA	P200/Pbe	Test No.	A	A _{SSD}	% Diff	Avg Diff	Dryback Requirement
Current										Gmm
										Gmm _{SSD}
Run Avg										

REMARKS

QUALITY CONTROL
 VERIFICATION
 INDEPENDENT ASSURANCE

CERTIFIED TECHNICIAN (PLEASE PRINT) AND CARD NUMBER	COMPANY NAME	SIGNATURE	DATE
---	--------------	-----------	------

VOIDS WORKSHEET GYRATORY

E English (E) or Metric (M)

PROJECT NAME (SECTION) Forms Sample						CONTRACT NUMBER 12345
CONTRACTOR OR SUPPLIER ODOT Forms				PROJECT MANAGER Sean Parker		BID ITEM NUMBER 123
ODOT MIX DESIGN NO. 17-MD0001	DESIGN Gsb 2.724	DESIGN Gmm 2.556	DESIGN VMA 14.8	DESIGN Va 4.0	DESIGN Pb 5.30%	MATERIAL TYPE L4 1/2" ACP
COMPACTOR MAKE Brovold	SERIAL NUMBER 59902	AC BRAND McCall	AC GRADE 70-22ER	AC Gb @ 60°F 1.043	NUMBER GYRATIONS 100	PLACEMENT TEMP RANGE 311-321

DATE 12/11/2017	TIME SAMPLED 7:00 PM	TIME COMPACTED 8:30 PM	LOT & SUBLOT 1-4
---------------------------	--------------------------------	----------------------------------	----------------------------

AASHTO T 166				AASHTO T 209		
	SPECIMEN ID	1	2	1	PYCNOMETER + LID + MIX	5599.6
	SPECIMEN HEIGHT	115.2	115.2	2	PYCNOMETER + LID	2924.4
	COMPACTED TEMP.	295	293	A	MASS OF DRY SAMPLE (1 - 2)	2675.2
A	MASS IN AIR	4828.3	4840.5	A_{SSD}	MASS OF SSD SAMPLE (uncoated porous agg.)	2676.8
C	MASS IN WATER	2847.4	2840.4	D	PYCNOMETER + LID + WATER	7327.8
B	MASS SSD	4831	4847.4	E	PYCNOMETER + LID + WATER + MIX	8962.8
Gmb	A / (B - C)	2.434	2.412	G	Gmm (pre) = A / (A + D - E)	
AVE	Gmb	2.423		H	Gmm _{SSD} = A / (A _{SSD} + D - E) (uncoated porous agg.)	2.568

<p>Va</p> $5.6 = \left(\frac{2.568 \cdot Gmm - 2.423 \cdot Gmb}{2.568 \cdot Gmm} \right) \times 100$ <p>VMA</p> $15.8 = 100 - \left(\frac{2.423 \cdot 94.64 \cdot Gmb}{2.724 \cdot Gsb} \right)$ <p>VFA</p> $65 = \frac{10.2 \cdot (VMA - Va)}{15.8} \times 100$ <p>P #200/Pbe</p> $1.21 = 5.3 / 4.37$	<p>Pb</p> <p>5.36</p> <p>Gsb 77°F</p> <p>1.039</p> <p>Gsb</p> <p>2.724</p> <p>P #200</p> <p>5.3</p>	<p>Ps</p> $94.64 = \frac{100 - Pb}{100} \cdot 5.36$ <p>Gse</p> $= \frac{Ps}{\frac{100}{Gmm} - \frac{Pb}{Gb}}$ <p>Pba</p> $= 100 \times \frac{(Gse - Gsb)}{(Gsb \times Gse)} \times Gb$ <p>Pbe</p> $= Pb - \left(\left(\frac{Pba}{100} \right) \times Ps \right)$
--	---	--

Previous Results					Dryback Trigger					
Test No	Va	VMA	VFA	P200/Pbe	Test No.	A	A _{SSD}	% Diff	Avg Diff	Dryback Requirement
Current	5.6	15.8	65	1.21	MDT	2485.6	2494.2	0.34%		Gmm
1-3	4.0	14.7	65	1.70	1-4	2675.2	2676.8	0.06%	0.20%	Gmm _{SSD}
1-2	3.8	15.0	69	1.19						X
1-1	6.0	17.0	72	1.45						
Run Avg	4.9	15.6	68	1.4						

REMARKS: Dryback Trigger based on MDT testing for MAMD (1-3) and Sublot (1-4) Volumetrics

<input type="checkbox"/> QUALITY CONTROL	<input type="checkbox"/> VERIFICATION	<input type="checkbox"/> INDEPENDENT ASSURANCE
CERTIFIED TECHNICIAN (PLEASE PRINT) AND CARD NUMBER Nathaniel Powell #44595	COMPANY NAME ODOT	SIGNATURE DATE 12/11/2017

VOIDS WORKSHEET GYRATORY

E English (E) or Metric (M)

PROJECT NAME (SECTION) Forms Sample						CONTRACT NUMBER 12345
CONTRACTOR OR SUPPLIER ODOT Forms				PROJECT MANAGER Sean Parker		BID ITEM NUMBER 123
ODOT MIX DESIGN NO. 17-MD0001	DESIGN Gsb 2.724	DESIGN Gmm 2.556	DESIGN VMA 14.8	DESIGN Va 4.0	DESIGN Pb 5.30%	MATERIAL TYPE L4 1/2" ACP
COMPACTOR MAKE Brovold	SERIAL NUMBER 59902	AC BRAND McCall	AC GRADE 70-22ER	AC Gb @ 60°F 1.043	NUMBER GYRATIONS 100	PLACEMENT TEMP RANGE 311-321
DATE 12/11/2017	TIME SAMPLED 7:00 PM	TIME COMPACTED 8:30 PM	LOT & SUBLOT 1-4			

AASHTO T 166				AASHTO T 209		
	SPECIMEN ID	1	2	1	PYCNOMETER + LID + MIX	5599.6
	SPECIMEN HEIGHT	115.2	115.2	2	PYCNOMETER + LID	2924.4
	COMPACTED TEMP.	295	293	A	MASS OF DRY SAMPLE (1 - 2)	2675.2
A	MASS IN AIR	4828.3	4840.5	A _{SSD}	MASS OF SSD SAMPLE (uncoated porous agg.)	2676.8
C	MASS IN WATER	2847.4	2840.4	D	PYCNOMETER + LID + WATER	7327.8
B	MASS SSD	4831	4847.4	E	PYCNOMETER + LID + WATER + MIX	8962.8
Gmb	A / (B - C)	2.434	2.412	G	Gmm (pre) = A / (A + D - E)	2.572
AVE	Gmb	2.423		H	Gmm _{SSD} = A / (A _{SSD} + D - E) (uncoated porous agg.)	

<p>Va</p> $5.8 = \left(\frac{2.572 \cdot Gmm - 2.423 \cdot Gmb}{2.572 \cdot Gmm} \right) \times 100$ <p>VMA</p> $15.8 = 100 - \left(\frac{2.423 \cdot Gmb \cdot PS}{2.724 \cdot Gsb} \right)$ <p>VFA</p> $63 = \frac{10.0 \cdot (VMA - Va)}{15.8 \cdot VMA} \times 100$ <p>P #200/Pbe</p> $1.24 = 5.3 / 4.29$	<p>Pb</p> <p>5.36</p> <p>Gb 77°F</p> <p>1.039</p> <p>Gsb</p> <p>2.724</p> <p>P #200</p> <p>5.3</p>	<p>Ps</p> $94.64 = 100 - 5.36$ <p>Gse</p> $2.807 = \frac{94.64 \cdot Ps}{2.572 \cdot Gmm - \frac{Pb}{Gb} \cdot 5.36}$ <p>Pba</p> $1.13 = 100 \times \frac{0.083 \cdot (Gse - Gsb)}{7.646 \cdot Gsb \cdot Gse} \times Gb$ <p>Pbe</p> $4.29 = Pb - \left(\left(\frac{Pba}{100} \right) \times Ps \right)$
---	--	---

Previous Results					Dryback Trigger					
Test No	Va	VMA	VFA	P200/Pbe	Test No.	A	A _{SSD}	% Diff	Avg Diff	Dryback Requirement
Current	5.8	15.8	63	1.24	MDT	2353.2	2354.2	0.04%		Gmm <input checked="" type="checkbox"/>
1-3	4.0	14.7	65	1.70	1-4	2675.2	2676.8	0.06%	0.05%	Gmm _{SSD} <input type="checkbox"/>
1-2	3.8	15.0	69	1.19						
1-1	6.0	17.0	72	1.45						
Run Avg	4.9	15.6	67	1.4						

REMARKS: Dryback Trigger based on MDT testing for MAMD (1-3) and Sublot (1-4) Volumetrics

<input type="checkbox"/> QUALITY CONTROL	<input type="checkbox"/> VERIFICATION	<input type="checkbox"/> INDEPENDENT ASSURANCE
CERTIFIED TECHNICIAN (PLEASE PRINT) AND CARD NUMBER Nathaniel Powell #44595	COMPANY NAME ODOT	SIGNATURE DATE 12/11/2017

TENSILE STRIPPING STRENGTH (TSR)

E English (E) or Metric (M)

PROJECT NAME (SECTION)				CONTRACT NUMBER	
CONTRACTOR OR SUPPLIER			PROJECT MANAGER		BID ITEM NUMBER
ODOT MIX DESIGN NO.	MAX SPECIFIC GRAVITY (Gmm)	% ASPHALT	NUMBER OF BLOWS	MIX NOMINAL SIZE	

DATE SAMPLED

Sample #	1	2	3	4	5	6	7	8
D. diameter, in								
t. thickness, in								
A. mass in air, g								
B. SSD. WT. g								
C. WT. in H2O, g								
E. Volume (B-C)								
F. Bulk SpSg (A/E)								
G. MAX SPECIFIC GRAVITY (Gmm)								
H. % voids ((G-F)/G)x100								
I. Vol of air voids (HxE)/100								
Test Cond. (Wet or Dry)								
X. Wt. gain for wet (0.75 x I)								
Target SSD Wt. (X+A)								
B' SSD Wt. after Sat.								
J' Vol absorbed H2O (B'-A)								
% saturation (J'/I)x100								

P. Load for dry sample									AVG
Std = $2P / (txDx3.14)$									

P' Load for wet sample									AVG
Stm = $2P' / (txDx3.14)$									

Tensile Strength Ratio = $(Stm / Std) 100$

Remarks

CERTIFIED TECHNICIAN (PLEASE PRINT) & CARD NUMBER	COMPANY NAME	SIGNATURE	DATE
---	--------------	-----------	------

TENSILE STRIPPING STRENGTH (TSR)

E English (E) or Metric (M)

PROJECT NAME (SECTION) Forms Example					CONTRACT NUMBER 12345	
CONTRACTOR OR SUPPLIER ODOT Forms			PROJECT MANAGER Sean Parker		BID ITEM NUMBER 123	
ODOT MIX DESIGN NO. 11-MD0001	MAX SPECIFIC GRAVITY (Gmm) 2.497	% ASPHALT 5.7	NUMBER OF BLOWS 35	MIX NOMINAL SIZE L3 1/2" Dense HMAC		

DATE SAMPLED **7/1/2011**

Sample #	1	2	3	4	5	6	7	8
D. diameter, in	4.001	4.001	4.001	4.001	4.001	4.001	4.001	4.001
t. thickness, in	2.481	2.481	2.481	2.481	2.481	2.481	2.481	2.481
A. mass in air, g	1201.9	1202.5	1202.3	1205.6	1205.6	1204.6	1205.6	1202.2
B. SSD. WT. g	1205.6	1207.9	1207.0	1211.2	1209.9	1209.6	1210.6	1206.8
C. WT. in H2O, g	687.5	688.9	687.3	689.2	688.7	690.2	689.0	690.1
E. Volume (B-C)	518.1	519.0	519.7	522.0	521.2	519.4	521.6	516.7
F. Bulk SpSg (A/E)	2.320	2.317	2.313	2.310	2.313	2.319	2.311	2.327
G. MAX SPECIFIC GRAVITY (Gmm)	2.497	2.497	2.497	2.497	2.497	2.497	2.497	2.497
H. % voids ((G-F)/G)x100	7.1	7.2	7.4	7.5	7.4	7.1	7.4	6.8
I. Vol of air voids (HxE)/100	36.79	37.37	38.46	39.15	38.57	36.88	38.60	35.14
Test Cond. (Wet or Dry)	Dry	Wet	Dry	Wet	Dry	Wet	Dry	Wet
X. Wt. gain for wet (0.75 x I)		28.0		29.4		27.7		26.4
Target SSD Wt. (X+A)		1230.5		1235.0		1232.3		1228.6
B' SSD Wt. after Sat.		1229.1		1236.1		1232.9		1228.3
J' Vol absorbed H2O (B'-A)		26.6		30.5		28.3		26.1
% saturation (J'/I)x100		71.2		77.9		76.7		74.3

P. Load for dry sample	1325		1425		1420		1422		AVG
Std = 2P / (txDx3.14)	85.0		91.4		91.1		91.2		89.7

P' Load for wet sample		1335		1310		1305		1330	AVG
Stm = 2P' / (txDx3.14)		85.7		84.1		83.7		85.3	84.7

Tensile Strength Ratio = (Stm / Std) 100 **94.4**

Remarks

CERTIFIED TECHNICIAN (PLEASE PRINT) & CARD NUMBER Scott Aker #43048	COMPANY NAME ODOT	SIGNATURE 	DATE 10/10/2012
---	-----------------------------	-------------------	---------------------------

**DEVELOPMENT OF ROLLER PATTERN
CONTROL STRIP METHOD OF COMPACTION
FOR THIN LIFTS OF ACP (TM301)**

E English (E) or Metric (M)

PROJECT NAME (SECTION)						CONTRACT NUMBER	
CONTRACTOR OR SUPPLIER				PROJECT MANAGER		BID ITEM NUMBER	
ODOT MIX DESIGN NO.	JMF PLACEMENT TEMP °F	LIFT THICKNESS <2"	TYPE GAUGE-SERIAL NUMBER			MIX NOMINAL SIZE	
MEASURED PLACEMENT TEMP °F		PANEL WIDTH	CONTROL STRIP NO.	LOT-SUBLOT	LIFT	DATE	
ROLLER TYPE AND DESCRIPTION (MANUFACTURER, WEIGHT, ETC)						CODES FOR ROLLER TYPES	
BREAKDOWN						P - PNEUMATIC	
INTERMEDIATE						TS - TANDEM STEEL	
FINISH						3WS - THREE WHEEL STEEL	
						SDV-SINGLE DRUM VIBRATORY	
						DDV-DOUBLE DRUM VIBRATORY	

NOTE: TW0 (2) EVALUATION POINTS IN AN AREA REPRESENTING THE OVERALL MATERIAL AND CONDITIONS OF PLACEMENT.
EVALUATION POINTS SHALL BE AT THE SAME STATION AT LEAST 1 METER (3 FT) APART TRANSVERSELY.
DENSITY TEST CANNOT BE TAKEN BEHIND PNEUMATIC ROLLER WHEN USED IN THE BREAKDOWN POSITION.

STATION	OFFSET DISTANCE FROM CENTERLINE		
	EVAL 1	EVAL 2	

INDICATE IF VIBRATION (V) OR STATIC (S) USED AND DIRECTION BY CIRCLING (F) FORWARD OR (B) BACK.

PASS	EVALUATION POINT 1					EVALUATION POINT 2					AVERAGE DENSITY	
	ROLLER	TEMP	F/B	DENSITY	S/V	ROLLER	TEMP	F/B	DENSITY	S/V		
1												
2												
3												
4												
5												
6												
7												
8												
9												
10												
11												
12												
13												
14												
15												
16												

REMARKS
THE OPTIMUM ROLLING PATTERN CONSISTS OF ONE LESS THAN THE NUMBER OF PASSES NECESSARY TO REACH THE POINT AT WHICH DENSITY DOES NOT INCREASE.

CERTIFIED TECHNICAN (PLEASE PRINT) AND CARD NUMBER	COMPANY NAME	SIGNATURE	DATE
--	--------------	-----------	------

**DEVELOPMENT OF ROLLER PATTERN
CONTROL STRIP METHOD OF COMPACTION
FOR THIN LIFTS OF ACP (TM301)**

E English (E) or Metric (M)

PROJECT NAME (SECTION) OR97: Lower Bridge Rd. (Terrebonne)					CONTRACT NUMBER C1971	
CONTRACTOR OR SUPPLIER Hooker Creek			PROJECT MANAGER Earl Mershon		BID ITEM NUMBER 420	
ODOT MIX DESIGN NO. 15-MD0027	JMF PLACEMENT TEMP °F 290-302	LIFT THICKNESS <2" 1 1/2"	TYPE GAUGE-SERIAL NUMBER Troxler 3440 #22252		MIX NOMINAL SIZE 1/2"	
MEASURED PLACEMENT TEMP °F 292		PANEL WIDTH 12 ft	CONTROL STRIP NO. QA-1	LOT-SUBLOT 2-1	LIFT 1	DATE 4/27/2015
ROLLER TYPE AND DESCRIPTION (MANUFACTURER, WEIGHT, ETC)					CODES FOR ROLLER TYPES	
BREAKDOWN	CAT CB534XW - DDV				P - PNEUMATIC	
INTERMEDIATE	CAT CB534 - DDV				TS - TANDEM STEEL	
FINISH	CAT CB24 - DDV				3WS - THREE WHEEL STEEL	
					SDV-SINGLE DRUM VIBRATORY	
					DDV-DOUBLE DRUM VIBRATORY	

NOTE: TW0 (2) EVALUATION POINTS IN AN AREA REPRESENTING THE OVERALL MATERIAL AND CONDITIONS OF PLACEMENT. EVALUATION POINTS SHALL BE AT THE SAME STATION AT LEAST 1 METER (3 FT) APART TRANSVERSELY. DENSITY TEST CANNOT BE TAKEN BEHIND PNEUMATIC ROLLER WHEN USED IN THE BREAKDOWN POSITION.

STATION	OFFSET DISTANCE FROM CENTERLINE			
"PE" 1217+44	EVAL 1	15ft rt	EVAL 2	19ft rt

INDICATE IF VIBRATION (V) OR STATIC (S) USED AND DIRECTION BY CIRCLING (F) FORWARD OR (B) BACK.

PASS	EVALUATION POINT 1					EVALUATION POINT 2					AVERAGE DENSITY
	ROLLER	TEMP	F/B	DENSITY	S/V	ROLLER	TEMP	F/B	DENSITY	S/V	
1	CAT CB534XW - DDV	280	F	128.3	v	CAT CB534XW - DDV	282	B	127.9	v	128.1
2	CAT CB534XW - DDV	273	F	131.2	v	CAT CB534XW - DDV	270	B	130.9	v	131.1
3	CAT CB534XW - DDV	254	F	133.0	s	CAT CB534XW - DDV	250	B	133.5	s/v	133.3
4	CAT CB534XW - DDV	225	F	134.6	s	CAT CB534XW - DDV	220	B	134.7	s/v	134.7
5	CAT CB534 - DDV	212	F	138.0	v	CAT CB534 - DDV	205	B	136.5	v	137.3
6	CAT CB534 - DDV	202	F	139.5	v	CAT CB534 - DDV	186	B	140.0	v	139.8
7	CAT CB534 - DDV	162	F	140.0	s	CAT CB534 - DDV	154	B	140.5	s	140.3
8	CAT CB534 - DDV	142	F	141.2	s	CAT CB534 - DDV	138	B	140.8	s	141.0
9	CAT CB534 - DDV	132	F	140.1	s	CAT CB534 - DDV	130	B	139.8	s	140.0
10											
11											
12											
13											
14											
15											
16											

REMARKS
THE OPTIMUM ROLLING PATTERN CONSISTS OF ONE LESS THAN THE NUMBER OF PASSES NECESSARY TO REACH THE POINT AT WHICH DENSITY DOES NOT INCREASE.

CERTIFIED TECHNICAN (PLEASE PRINT) AND CARD NUMBER Josh Huber #42332	COMPANY NAME ODOT R1 QA	SIGNATURE	DATE 4/27/2015
--	-----------------------------------	-----------	--------------------------

FIELD WORKSHEET FOR ACP (PLANT REPORT)

EA(AC) **E** English (E) Metric (M)

PROJECT NAME (SECTION) Form Example		ODOT MIX DESIGN NO. 18-MID0000	TEST NO. 1-1	CONTRACT NUMBER 12345
CONTRACTOR OR SUPPLIER ODOT Forms		DATE 5/25/2018	AMOUNT REPRESENTED 1,000 tons	BID ITEM NUMBER 123
SOURCE NAME Rocks R US		PROJECT MANAGER Sean Parker	(EAC OR ACP) ACP	MIX NOMINAL SIZE 1/2"
PLANT / MODEL Gencore		TO BE USED IN L4, 1/2" ACP	SAMPLED AT Drum Discharge	JMF MIX TEMP. 337-350
TYPE Drum		SIZE 500	MIX TEMP. 340	

SIEVE SIZE	SIEVE ANALYSIS		INCINERATOR CORR. FACTOR	CORRECTED % PASSING	JOB MIX FORMULA		SIEVE SIZE	COLD FEED MOISTURE	
	MASS 1	MASS 2			TOTAL MASS	% RET		% PASS	TARGET
3/4	0.0	0.0	0.0	100.0	100	0	0	1291.3	
1/2	63.3	63.3	4.5	95.5	100	0	0	3739.7	
3/8	216.0	216.0	15.2	80.3	100	0	0	3630.4	
1/4	268.9	268.9	18.9	61.4	100	100	95-100	4.7	
4	102.6	102.6	7.2	54.2	96	1/2	90-100	242	
8	238.5	238.5	16.8	37.4	80	3/8	33-41	99.5	
16	185.3	185.3	13.0	24.4	61	1/4	48-58	1164.0	
30	105.9	105.9	7.4	17.0	54	4	14-22	1161.8	
50	66.8	66.8	4.7	12.3	37	8	4.2-8.2	0.21	
100	45.3	45.3	3.2	9.1	24	16	4.70-5.70		
200	28.4	28.4	2.0	7.1	17	30			
Pan	3.6	3.6	0.3		12	50			
INITIAL DRY MASS					1422.3				

METER READINGS																							
BEGINNING	ENDING	SUB TOTAL	MOISTURE	WET AGG		WET RAP		WET RAS															
				A	B	C	D	E	F	G	H												
6.87	9.38	2.51	4.7	131.33	179.29	47.96	4.7	35.62	46.43	10.81	5.6	53.11	54.18	1.07	1.3	1.06	1.06	4.21	19.8	1.9	19.5		
TOTAL				2.51	45.81	10.24	10.24	10.24	10.24	10.24	10.24	10.24	10.24	10.24	10.24	10.24	10.24	10.24	10.24	10.24	10.24	10.24	10.24

T-308 METHOD A or B												
BASKET TARE	MIX MASS & BASKET	AGG MASS & BASKET	COOL AGG & BASKET	MIX MOISTURE	(Mf) = (A-T)/(1+(%M/100))	(Mi) = (B - T)	(Mf) = [(Mi - Mf) / (Mi)] x 100	% INCINERATED	CORRECTION FACTOR	% AC, Pb = (% I - Cf)		
B	3074.1	A	4585.8	B	4494.1	4496.4	0.21	236	234	5.87	0.64	5.23
REMARKS: Mass After Sieve (D) 1324.6 SL = [(C-T)/(C-T)] x 100 = -0.2												

CERTIFIED TECHNICIAN (PLEASE PRINT) AND CARD NUMBER Barbara L. Worthington #42736		COMPANY NAME ODOT		SIGNATURE		DATE 5/25/2018	
QUALITY CONTROL VERIFICATION INDEPENDENT ASSURANCE							

FIELD WORKSHEET FOR ACP (PLANT REPORT)

EA(AC) **E** English (E) Metric (M)

PROJECT NAME (SECTION) Form Example		TEST NO. 1-1		CONTRACT NUMBER 12345	
CONTRACTOR OR SUPPLIER ODOT Forms		AMOUNT REPRESENTED 1,000 tons		BID ITEM NUMBER 123	
SOURCE NAME Rocks R US		DATE 5/25/2018		MIX NOMINAL SIZE 1/2"	
PROJECT MANAGER Sean Parker		TIME 9:47 PM		JMF MIX TEMP. 337-350	
SOURCE NUMBER 12-345-1		SAMPLED AT Drum Discharge		MIX TEMP. 340	
TO BE USED IN L4, 1/2" ACP					
TYPE Drum		SIZE 500			

SIEVE SIZE	SIEVE ANALYSIS		CORRECTED % PASSING	INCINERATOR CORR. FACTOR	JOB MIX FORMULA TARGET	TOLERANCE	SIEVE SIZE	COLD FEED MOISTURE	
	MASS 1	MASS 2						WET TARE	DRY TARE
3/4	0.0	0.0	100.0		100	0	0	1291.3	1291.3
1/2	63.3	63.3	100.0		100	0	0	3739.7	3739.7
3/8	216.0	216.0	100.0		100	0	0	3630.4	3630.4
1/4	268.9	268.9	100.0		100	3/4	3/4	4.7	4.7
4	102.6	102.6	95.5		96	1/2	1/2	242	242
8	238.5	238.5	80.3		80	3/8	3/8	99.5	99.5
16	185.3	185.3	61.4		61	1/4	1/4	1164.0	1164.0
30	105.9	105.9	54.2		54	4	4	1161.8	1161.8
50	66.8	66.8	37.4		37	8	8	0.21	0.21
100	45.3	45.3	24.4		24	16	16		
200	28.4	28.4	17.0		17	30	30		
Pan	3.6	3.6	12.3		12	50	50		
			9.1		9	100	100		
			7.1		7.1	200	200		
			0.3						
INITIAL DRY MASS		1422.3							

SIEVE SIZE	SIEVE ANALYSIS		CORRECTED % PASSING	INCINERATOR CORR. FACTOR	JOB MIX FORMULA TARGET	TOLERANCE	SIEVE SIZE	COLD FEED MOISTURE	
	MASS 1	MASS 2						WET TARE	DRY TARE
3/4	0.0	0.0	100.0		100	0	0	1291.3	1291.3
1/2	63.3	63.3	100.0		100	0	0	3739.7	3739.7
3/8	216.0	216.0	100.0		100	0	0	3630.4	3630.4
1/4	268.9	268.9	100.0		100	3/4	3/4	4.7	4.7
4	102.6	102.6	95.5		96	1/2	1/2	242	242
8	238.5	238.5	80.3		80	3/8	3/8	99.5	99.5
16	185.3	185.3	61.4		61	1/4	1/4	1164.0	1164.0
30	105.9	105.9	54.2		54	4	4	1161.8	1161.8
50	66.8	66.8	37.4		37	8	8	0.21	0.21
100	45.3	45.3	24.4		24	16	16		
200	28.4	28.4	17.0		17	30	30		
Pan	3.6	3.6	12.3		12	50	50		
			9.1		9	100	100		
			7.1		7.1	200	200		
			0.3						
INITIAL DRY MASS		1422.3							

SIEVE SIZE	SIEVE ANALYSIS		CORRECTED % PASSING	INCINERATOR CORR. FACTOR	JOB MIX FORMULA TARGET	TOLERANCE	SIEVE SIZE	COLD FEED MOISTURE	
	MASS 1	MASS 2						WET TARE	DRY TARE
3/4	0.0	0.0	100.0		100	0	0	1291.3	1291.3
1/2	63.3	63.3	100.0		100	0	0	3739.7	3739.7
3/8	216.0	216.0	100.0		100	0	0	3630.4	3630.4
1/4	268.9	268.9	100.0		100	3/4	3/4	4.7	4.7
4	102.6	102.6	95.5		96	1/2	1/2	242	242
8	238.5	238.5	80.3		80	3/8	3/8	99.5	99.5
16	185.3	185.3	61.4		61	1/4	1/4	1164.0	1164.0
30	105.9	105.9	54.2		54	4	4	1161.8	1161.8
50	66.8	66.8	37.4		37	8	8	0.21	0.21
100	45.3	45.3	24.4		24	16	16		
200	28.4	28.4	17.0		17	30	30		
Pan	3.6	3.6	12.3		12	50	50		
			9.1		9	100	100		
			7.1		7.1	200	200		
			0.3						
INITIAL DRY MASS		1422.3							

SIEVE SIZE	SIEVE ANALYSIS		CORRECTED % PASSING	INCINERATOR CORR. FACTOR	JOB MIX FORMULA TARGET	TOLERANCE	SIEVE SIZE	COLD FEED MOISTURE	
	MASS 1	MASS 2						WET TARE	DRY TARE
3/4	0.0	0.0	100.0		100	0	0	1291.3	1291.3
1/2	63.3	63.3	100.0		100	0	0	3739.7	3739.7
3/8	216.0	216.0	100.0		100	0	0	3630.4	3630.4
1/4	268.9	268.9	100.0		100	3/4	3/4	4.7	4.7
4	102.6	102.6	95.5		96	1/2	1/2	242	242
8	238.5	238.5	80.3		80	3/8	3/8	99.5	99.5
16	185.3	185.3	61.4		61	1/4	1/4	1164.0	1164.0
30	105.9	105.9	54.2		54	4	4	1161.8	1161.8
50	66.8	66.8	37.4		37	8	8	0.21	0.21
100	45.3	45.3	24.4		24	16	16		
200	28.4	28.4	17.0		17	30	30		
Pan	3.6	3.6	12.3		12	50	50		
			9.1		9	100	100		
			7.1		7.1	200	200		
			0.3						
INITIAL DRY MASS		1422.3							

SIEVE SIZE	SIEVE ANALYSIS		CORRECTED % PASSING	INCINERATOR CORR. FACTOR	JOB MIX FORMULA TARGET	TOLERANCE	SIEVE SIZE	COLD FEED MOISTURE	
	MASS 1	MASS 2						WET TARE	DRY TARE
3/4	0.0	0.0	100.0		100	0	0	1291.3	1291.3
1/2	63.3	63.3	100.0		100	0	0	3739.7	3739.7
3/8	216.0	216.0	100.0		100	0	0	3630.4	3630.4
1/4	268.9	268.9	100.0		100	3/4	3/4	4.7	4.7
4	102.6	102.6	95.5		96	1/2	1/2	242	242
8	238.5	238.5	80.3		80	3/8	3/8	99.5	99.5
16	185.3	185.3	61.4		61	1/4	1/4	1164.0	1164.0
30	105.9	105.9	54.2		54	4	4	1161.8	1161.8
50	66.8	66.8	37.4		37	8	8	0.21	0.21
100	45.3	45.3	24.4		24	16	16		
200	28.4	28.4	17.0		17	30	30		
Pan	3.6	3.6	12.3		12	50	50		
			9.1		9	100	100		
			7.1		7.1	200	200		
			0.3						
INITIAL DRY MASS		1422.3							

SIEVE SIZE	SIEVE ANALYSIS		CORRECTED % PASSING	INCINERATOR CORR. FACTOR	JOB MIX FORMULA TARGET	TOLERANCE	SIEVE SIZE	COLD FEED MOISTURE	
	MASS 1	MASS 2						WET TARE	DRY TARE
3/4	0.0	0.0	100.0		100	0	0	1291.3	1291.3
1/2	63.3	63.3	100.0		100	0	0	3739.7	3739.7
3/8	216.0	216.0	100.0		100	0	0	3630.4	3630.4
1/4	268.9	268.9	100.0		100	3/4	3/4	4.7	4.7
4	102.6	102.6	95.5		96	1/2	1/2	242	242
8	238.5	238.5	80.3		80	3/8	3/8	99.5	99.5
16	185.3	185.3	61.4		61	1/4	1/4	1164.0	1164.0
30	105.9	105.9	54.2		54	4	4	1161.8	1161.8
50	66.8	66.8	37.4		37	8	8	0.21	0.21
100	45.3	45.3	24.4		24	16	16		
200	28.4	28.4	17.0		17	30	30		
Pan	3.6	3.6	12.3		12	50	50		
			9.1		9	100	100		
			7.1		7.1	200	200		
			0.3						
INITIAL DRY MASS		1422.3							

SIEVE SIZE	SIEVE ANALYSIS		CORRECTED % PASSING	INCINERATOR CORR. FACTOR	JOB MIX FORMULA TARGET	TOLERANCE	SIEVE SIZE	COLD FEED MOISTURE	
	MASS 1	MASS 2						WET TARE	DRY TARE
3/4	0.0	0.0	100.0		100	0	0	1291.3	1291.3
1/2	63.3	63.3	100.0		100	0	0	3739.7	3739.7
3/8	216.0	216.0	100.0		100	0	0	3630.4	3630.4
1/4	268.9	268.9	100.0		100	3/4	3/4	4.7	4.7
4	102.6	102.6	95.5		96	1/2	1/2	242	242
8	238.5	238.5	80.3		80	3/8	3/8	99.5	99.5
16	185.3	185.3	61.4		61	1/4	1/4	1164.0	1164.0
30	105.9	105.9	54.2		54	4	4	1161.8	1161.8
50	66.8	66.8	37.4		37	8	8	0.21	0.21
100	45.3	45.3	24.4		24	16	16		
200	28.4	28.4	17.0		17	30	30		
Pan	3.6	3.6	12.3		12	50	50		
			9.1		9	100	100		
			7.1		7.1	200	200		
			0.3						
INITIAL DRY MASS		1422.3							

SIEVE SIZE	SIEVE ANALYSIS		CORRECTED % PASSING	INCINERATOR CORR. FACTOR	JOB MIX FORMULA TARGET	TOLERANCE	SIEVE SIZE	COLD FEED MOISTURE	
	MASS 1	MASS 2						WET TARE	DRY TARE
3/4	0.0	0.0	100.0		100	0	0	1291.3	1291.3
1/2	63.3	63.3	100.0		100	0	0	3739.7	3739.7
3/8	216.0	216.0	100.0		100	0	0	3630.4	

NUCLEAR - CORE CORRELATION WORKSHEET

E

English (E) Metric (M)

PROJECT NAME (SECTION)					CONTRACT NUMBER	
CONTRACTOR OR SUPPLIER			PROJECT MANAGER			BID ITEM NUMBER
ODOT MIX DESIGN NO.	TYPE GAUGE - SERIAL NUMBER	LIFT	DEPTH OF LIFT	MATERIAL TYPE	Core Correlation ID	

UNDERLYING MATERIAL (ACP / GRIND / AGG BASE)					CORE DENSITY					
LOT SUBLOT	T E S T	SHOT #1	SHOT #2	NUCLEAR DENSITY AVERAGE	CORE THICKNESS	(A) MASS IN AIR	(C) MASS IN WATER	(B) SSD MASS	A B-C X 62.4	
	1									
	2									
	3									
	4									
	5									
	6									
	7									
	8									
	9									
	10									

T E S T	Difference Core - Nuclear	VALUES NOT USED
1		
2		
3		
4		
5		
6		
7		
8		
9		
10		
Average		
Standard Deviation		

CORRELATION FACTOR

(TO ONE DECIMAL PLACES)

a. If the standard deviation exceeds 2.5 lb/ft³ the value with the greatest deviation from the average is not used.

b. If less than 8 values remain, obtain more gauge readings and cores.

$$\text{Standard Deviation} = \sqrt{\frac{\sum x^2}{n-1}}$$

2.5 MAX

<input type="checkbox"/> QUALITY CONTROL	<input type="checkbox"/> VERIFICATION		
CERTIFIED TECHNICIAN CDT (PLEASE PRINT) AND CARD NUMBER	COMPANY NAME	SIGNATURE	DATE
CERTIFIED TECHNICIAN CAT 1 (PLEASE PRINT) AND CARD NUMBER	COMPANY NAME	SIGNATURE	DATE
CERTIFIED TECHNICIAN QCCS (PLEASE PRINT) AND CARD NUMBER	COMPANY NAME	SIGNATURE	DATE

NUCLEAR - CORE CORRELATION WORKSHEET

E

English (E) Metric (M)

PROJECT NAME (SECTION) <p style="text-align: center;">Forms Example</p>					CONTRACT NUMBER <p style="text-align: center;">12345</p>	
CONTRACTOR OR SUPPLIER <p style="text-align: center;">ODOT Forms</p>			PROJECT MANAGER <p style="text-align: center;">Sean Parker</p>		BID ITEM NUMBER <p style="text-align: center;">123</p>	
ODOT MIX DESIGN NO. <p style="text-align: center;">18-MD0000</p>	TYPE GAUGE - SERIAL NUMBER <p style="text-align: center;">Troxler 3430 #11111</p>	LIFT <p style="text-align: center;">2nd</p>	DEPTH OF LIFT <p style="text-align: center;">2"</p>	MATERIAL TYPE <p style="text-align: center;">L3 1/2"</p>	Core Correlation ID <p style="text-align: center;">12345-1</p>	

UNDERLYING MATERIAL (ACP / GRIND / AGG BASE)										
HMAC										
LOT SUBLOT	T E S T	SHOT #1	SHOT #2	NUCLEAR DENSITY AVERAGE	CORE DENSITY					
					CORE THICKNESS	(A) MASS IN AIR	(C) MASS IN WATER	(B) SSD MASS	$\frac{A}{B-C}$ X	62.4
1-1-1	1	139.7	140.3	140	1.8	1867.3	1073.1	1885.7	2.298	143.4
1-1-2	2	138.8	138.8	138.8	1.5	1371.2	782.9	1384.2	2.280	142.3
1-1-3	3	139	139.8	139.4	1.6	1625.3	928.4	1639.9	2.284	142.5
1-1-4	4	139	139.2	139.1	1.7	1641.4	941.4	1660.4	2.283	142.5
1-1-5	5	140.5	140.1	140.3	1.7	1700.9	965.6	1716.9	2.264	141.3
1-2-1	6	137.1	138.6	137.9	1.7	1698.0	988.6	1725.9	2.303	143.7
1-2-2	7	138.2	138.8	138.5	1.9	1943.3	1127.3	1974.9	2.293	143.1
1-2-3	8	144.9	146.2	145.6	2.5	3241.2	1883.2	3250.9	2.370	147.9
1-2-4	9	142.8	143	142.9	2.1	2291.5	1325.2	2308.1	2.331	145.5
1-2-5	10	142.9	142.9	142.9	2.1	2285.3	1325.3	2309.3	2.322	144.9

T E S T	Difference Core - Nuclear	VALUES NOT USED
1	3.4	
2	3.5	
3	3.1	
4	3.4	
5	1.0	
6	5.8	
7	4.6	
8	2.3	
9	2.6	
10	2.0	
Average		
3.2		
Standard Deviation		
1.35		

CORRELATION FACTOR

3.2

(TO ONE DECIMAL PLACES)

- a.** If the standard deviation exceeds 2.5 lb/ft³ the value with the greatest deviation from the average is not used.
- b.** If less than 8 values remain, obtain more gauge readings and cores.

$$\text{Standard Deviation} = \sqrt{\frac{\sum x^2}{n-1}}$$

2.5 MAX

<input checked="" type="checkbox"/> QUALITY CONTROL		<input type="checkbox"/> VERIFICATION	
CERTIFIED TECHNICIAN CDT (PLEASE PRINT) AND CARD NUMBER	COMPANY NAME	SIGNATURE	DATE
Scott Aker #43048	ODOT		10/9/2018
CERTIFIED TECHNICIAN CAT 1 (PLEASE PRINT) AND CARD NUMBER	COMPANY NAME	SIGNATURE	DATE
Scott Aker #43048	ODOT		10/9/2018
CERTIFIED TECHNICIAN QCCS (PLEASE PRINT) AND CARD NUMBER	COMPANY NAME	SIGNATURE	DATE
Sean Parker #12345	ODOT		10/9/2018

CALIBRATION BATCH FORM

SAMPLE No.

English (E) or Metric (M)

PROJECT NAME (SECTION)				CONTRACT NUMBER
CONTRACTOR OR SUPPLIER			PROJECT MANAGER	
MIX DESIGN NO.		DESIGN RAP % (%RAP)	DESIGN ANTISTRIP %	DESIGN ASPHALT % (P _b)
AGG SOURCE No.		RAP SOURCE	ANTISTRIP SUPPLIER	AC SUPPLIER
AGG % Absorbion	RAP % ASPHALT (P _{br})	ANTISTRIP % Solids	AC GRADE	MASS OF SAMPLE (M _{mix}) Grams

Mass of Asphalt Cement =	(Mass of Sample x Design Asphalt %) / 100	_____
Mass of Aggregate =	Mass of Sample - Mass of Asphalt Cement	_____
Mass of Asphalt Cement in RAP =	$M_{mix} \times [(1 - P_b / 100) / \{(100 / \%RAP - 1) \times (100 / P_{br}) + (100 / P_{br} - 1)\}]$	0.0
Mass of Aggregate in RAP =	Mass of Asphalt Cement in RAP x (100 / RAP % Asphalt - 1)	0.0
Mass of RAP =	Mass of Asphalt Cement in RAP + Mass of Aggregate in RAP	0.0
Mass of Virgin Aggregate =	Mass of Aggregate - Mass of Aggregate in RAP	_____
Mass of Virgin Aggregate without Antistrip =	Mass of Virgin Aggregate / (100 + DESIGN ANTISTRIP %) x 100	_____
Mass of Antistrip in Virgin Aggregate =	Mass of Virgin Aggregate - Mass of Virgin Agg w/o Antistrip	_____
Mass of Virgin Asphalt Cement =	Mass of Asphalt Cement - Mass of Asphalt Cement in RAP	_____
(P_b) Virgin Asphalt Cement Percentage =	$\frac{\text{Mass of Virgin Asphalt Cement}}{\text{Mass of Virgin Aggregate} + \text{Mass of Virgin Asphalt Cement}}$	_____

Batching Detail

Sieve	JMF % Pass	RAP % Pass	Virgin AGG Target		DRY VIRGIN AGGREGATE BATCHING WEIGHTS		
			% Pass	% Retain	Individual	Accumulative	Actual
1 in (25.0mm)							
¾ in (19.0mm)							
½ in (12.5mm)							
¾ in (9.5mm)							
¼ in (6.3mm)							
No 4 (4.75mm)							
No 8 (2.36mm)							
No 16 (1.18mm)							
No 30 (600um)							
No 50 (300um)							
No 100 (150um)							
No 200 (75um)							
Pan	Without ANTISTRIP						

Mix Designs Follow TM 316 (ADDING ANTI-STRIP ADDITIVES OR LIME TO MIX DESIGN SAMPLES)

TM 323 Add 0.1% More Moisture than AGG	Moisture				
% Absorbion MIX add lime MIX AGAIN	ANTISTRIP				

All Ingredients and Utensils are Weighed in Hot Condition		Accumulative	Actual
BUTTERED MIXING BOWL and SPOON			
Aggregate	Mass of DRY AGG, ANTISTRIP, BOWL & SPOON		
Asphalt	Actual Mass of DRY AGG X P _b / 100 - P _b		
RAP	Weigh the Sample after mixing before transferring to another container		
BUTTERED MIXING BOWL and SPOON With in 1 Gram of Previous Tare weight			
SAMPLE OF HMAC			

ACTUAL RAP AGG	<input style="width: 100%; height: 20px;" type="text"/>	ACTUAL RAP ASPHALT	<input style="width: 100%; height: 20px;" type="text"/>
ACTUAL VIRG AGG	<input style="width: 100%; height: 20px;" type="text"/>	ACTUAL VIRG ASPHALT	<input style="width: 100%; height: 20px;" type="text"/>
ACTUAL AGG TOTAL	<input style="width: 100%; height: 20px;" type="text"/>	ACTUAL ASPHALT TOTAL	<input style="width: 100%; height: 20px;" type="text"/>
			% ASPHALT <input style="width: 100px; height: 20px;" type="text"/>

<input type="checkbox"/> QUALITY CONTROL	<input type="checkbox"/> VERIFICATION	
CERTIFIED TECHNICIAN (PLEASE PRINT) AND CARD NUMBER	COMPANY NAME	SIGNATURE
		DATE

CALIBRATION BATCH FORM

SAMPLE No. 3

E English (E) or Metric (M)

PROJECT NAME (SECTION) <p style="text-align: center;">Forms Example</p>				CONTRACT NUMBER <p style="text-align: center;">12345</p>
CONTRACTOR OR SUPPLIER <p style="text-align: center;">ODOT Forms</p>		PROJECT MANAGER <p style="text-align: center;">Sean Parker</p>		BID ITEM NUMBER <p style="text-align: center;">123</p>
MIX DESIGN NO. <p style="text-align: center;">12-MD0001</p>	DESIGN RAP % (%RAP)	DESIGN ANTISTRIP % <p style="text-align: center;">0.375</p>	DESIGN ASPHALT % (P _b) <p style="text-align: center;">5.5</p>	MATERIAL TYPE <p style="text-align: center;">L3 3/4" Dense</p>
AGG SOURCE No. <p style="text-align: center;">10-001-3</p>	RAP SOURCE <p style="text-align: center;">Hwy 20</p>	ANTISTRIP SUPPLIER <p style="text-align: center;">Ultrapave</p>	AC SUPPLIER <p style="text-align: center;">Albina3</p>	MIXING TEMP RANGE <p style="text-align: center;">300-304</p>
AGG % Absorbtion <p style="text-align: center;">2.3</p>	RAP % ASPHALT (P _{br}) <p style="text-align: center;">6.3</p>	ANTISTRIP % Solids <p style="text-align: center;">69</p>	AC GRADE <p style="text-align: center;">PG 70-28</p>	MASS OF SAMPLE (M _{mix}) <p style="text-align: center;">2100 Grams</p>

Mass of Asphalt Cement =	(Mass of Sample x Design Asphalt %) / 100	115.5
Mass of Aggregate =	Mass of Sample - Mass of Asphalt Cement	1984.5
Mass of Asphalt Cement in RAP =	$M_{mix} \times [(1 - P_b / 100) / \{(100 / \%RAP - 1) \times (100 / P_{br})\} + (100 / P_{br} - 1)]$	0.0
Mass of Aggregate in RAP =	Mass of Asphalt Cement in RAP x (100 / RAP % Asphalt - 1)	0.0
Mass of RAP =	Mass of Asphalt Cement in RAP + Mass of Aggregate in RAP	0.0
Mass of Virgin Aggregate =	Mass of Aggregate - Mass of Aggregate in RAP	1984.5
Mass of Virgin Aggregate without Antistrip =	Mass of Virgin Aggregate / (100 + DESIGN ANTISTRIP %) x 100	1977.1
Mass of Antistrip in Virgin Aggregate =	Mass of Virgin Aggregate - Mass of Virgin Agg w/o Antistrip	7.4
Mass of Virgin Asphalt Cement =	Mass of Asphalt Cement - Mass of Asphalt Cement in RAP	115.5
(P_b) Virgin Asphalt Cement Percentage =	$\frac{\text{Mass of Virgin Asphalt Cement}}{\text{Mass of Virgin Aggregate} + \text{Mass of Virgin Asphalt Cement}}$	5.50%

Batching Detail

Sieve	JMF % Pass	RAP % Pass	Virgin AGG Target		DRY VIRGIN AGGREGATE BATCHING WEIGHTS		
			% Pass	% Retain	Individual	Accumulative	Actual
1 in	100		100.0	0.0	0.0	0.0	0
¾ in	96		96.0	4.0	79.4	79.4	79.2
½ in	80		79.9	16.1	317.5	396.9	396.8
¾ in	69		68.9	11.0	218.3	615.2	615.1
¼ in	54		53.8	15.1	297.7	912.9	912.9
No 4	44		43.8	10.0	198.5	1111.3	1111.2
No 8	25		24.7	19.1	377.1	1488.4	1488.4
No 16	18		17.7	7.0	138.9	1627.3	1627.3
No 30	11		10.7	7.0	138.9	1766.2	1766.2
No 50	9		8.7	2.0	39.7	1805.9	1805.9
No 100	7		6.6	2.0	39.7	1845.6	1845.6
No 200	5.0		4.6	2.0	39.7	1885.3	1885.3
Pan	Without ANTISTRIP		4.6		91.8	1977.1	1977.1

Mix Designs Follow TM 316 (ADDING ANTI-STRIP ADDITIVES OR LIME TO MIX DESIGN SAMPLES)

TM 323 Add 0.1% More Moisture than AGG % Absorbtion MIX add lime MIX AGAIN	Moisture	2.4%	47.5	2024.5	2024.5
	ANTISTRIP	0.4%	7.4	2032.0	2032

All Ingredients and Utensils are Weighed in Hot Condition				Accumulative	Actual
BUTTERED MIXING BOWL and SPOON				1000.0	1001.2
Aggregate	1983.3	Mass of DRY AGG, ANTISTRIP, BOWL & SPOON		2984.5	2984.5
Asphalt	115.4	Actual Mass of DRY AGG X Pb / 100 - Pb		3099.9	3099.9
RAP	0.0	Weigh the Sample after mixing before transferring to another container		3099.9	3099.9
BUTTERED MIXING BOWL and SPOON With in 1 Gram of Previous Tare weight				1000.0	1000.6
SAMPLE OF HMAC				2099.9	2100.8

ACTUAL RAP AGG	0.0	ACTUAL RAP ASPHALT	0.0
ACTUAL VIRG AGG	1983.3	ACTUAL VIRG ASPHALT	115.4
ACTUAL AGG TOTAL	1983.3	ACTUAL ASPHALT TOTAL	115.4
			% ASPHALT 5.50%

<input checked="" type="checkbox"/> QUALITY CONTROL	<input type="checkbox"/> VERIFICATION	CERTIFIED TECHNICIAN (PLEASE PRINT) AND CARD NUMBER	COMPANY NAME	SIGNATURE	DATE
		Scott Aker #43048	ODOT		10/7/2012

ACP INCINERATOR OVEN CALIBRATION WORKSHEET

PROJECT NAME (SECTION)	ODOT Forms		PROJECT MANAGER	CONTRACT NUMBER	ASPHALT SUPPLIER	ODOT MIX DESIGN NO.
CONTRACTOR OR SUPPLIER	Best Paving Company		Sean Parker	12345	Paramount	20-MD0001
			MATERIAL TYPE	PERCENT RAP	ASPHALT GRADE	CONTRACTOR DESIGN #
			Level 3 1/2" Dense	25	PG 70-22	BPC-001

INCINERATOR MAKE	Troxler	SERIAL NUMBER	160	BURN METHOD (A OR B)		INCINERATOR SAMPLE #	3	INCINERATOR SAMPLE #	7	
				BLANK	RAP					BASKET TARE
PAN TARE	1311.8	BASKET TARE	T	4461.7		4504.2		4504.2		
WET MASS & PAN	2403.3	MIX MASS & BASKET	A	4812.8		6033.8		6033.8		
DRY MASS & PAN	2403.3	AGG MASS & BASKET	B	4812.8		5930.8		5930.8		
		COOL AGG & BASKET		4812.8		5930.8		5930.8		
		TEMP	70.0	Mi (A-T)	351.1	1529.6		71.0	Mi (A-T)	
		TEMP	72.0	Mf (B-T)	351.1	1426.6		73.0	Mf (B-T)	
		%I = [(Mi -Mf) / (Mi)] x 100			0.00	6.73		%I = [(Mi -Mf) / (Mi)] x 100		
Sieve	Mass	% Ret	%Pass	Mass	% Ret	%Pass	Sieve	Mass	% Ret	%Pass
1	0.0	0.0	100.0	0.0	0.0	100.0	1	0.0	0.0	100.0
3/4	0.0	0.0	100.0	0.0	0.0	100.0	3/4	0.0	0.0	100.0
1/2	52.0	4.8	95.2	30.7	8.7	91.3	1/2	53.3	3.7	96.3
3/8	181.5	16.6	78.6	8.2	2.3	89.0	3/8	209.4	14.7	81.6
1/4	228.9	21.0	57.6	48.4	13.8	75.2	1/4	241.4	16.9	64.7
4	202.0	18.5	39.1	35.8	10.2	65.0	4	237.0	16.6	48.1
6	106.0	9.7	29.4	37.0	10.5	54.5	6	128.4	9.0	39.1
8	58.7	5.4	24.0	30.7	8.7	45.8	8	93.1	6.5	32.6
16	72.1	6.6	17.4	38.4	10.9	34.9	16	100.0	7.0	25.6
30	72.2	6.6	10.8	38.5	11.0	23.9	30	135.7	9.5	16.1
50	28.2	2.6	8.2	19.0	5.4	18.5	50	50.0	3.5	12.6
100	28.2	2.6	5.6	19.1	5.4	13.1	100	50.0	3.5	9.1
200	28.4	2.6	3.0	19.1	5.4	7.7	200	57.5	4.0	5.1
PAN	4.0	Initial Mass	1091.5	PAN	4.7	Initial Mass	PAN	6.4	Initial Mass	1426.6
AFTER WASH DRY MASS	1062.2	AFTER WASH DRY MASS	329.7	AFTER WASH DRY MASS	329.7	AFTER WASH DRY MASS	1362.0	AFTER WASH DRY MASS	9.3	Initial Mass
MASS AFTER SIEVE	1062.2	MASS AFTER SIEVE	329.6	MASS AFTER SIEVE	329.6	MASS AFTER SIEVE	1362.2	MASS AFTER SIEVE	1365.4	MASS AFTER SIEVE
Sieve loss	0.0%	Sieve loss	0.0%	Sieve loss	0.0%	Sieve loss	0.0%	Sieve loss	0.0%	Sieve loss

SIEVE	TARGET	BLANK/RAP	MIX # 1	MIX # 2	AVE 1 & 2		DIFF TARGET-BLANK	FACTOR
					100.0	100.0		
1	100	100.0	100.0	100.0	100.0	0.0	0.0	1
3/4	100	100.0	100.0	100.0	100.0	0.0	0.0	3/4
1/2	96	94.3	96.3	97.7	97.0	1.7	-2.7	1/2
3/8	81	81.2	81.6	81.4	81.5	-0.2	-0.3	3/8
1/4	65	62.0	64.7	64.8	64.8	3.0	-2.8	1/4
4	47	45.5	48.1	48.1	48.1	1.5	-2.6	4
6	39	35.6	39.1	38.5	38.8	3.4	-3.2	6
8	32	29.4	32.6	32.4	32.5	2.6	-3.1	8
16	25	21.7	25.6	25.4	25.5	3.3	-3.8	16
30	16	14.0	16.1	16.0	16.1	2.0	-2.1	30
50	12	10.7	12.6	12.5	12.6	1.3	-1.9	50
100	9	7.4	9.1	9.0	9.1	1.6	-1.7	100
200	5.1	4.1	5.1	4.9	5.0	1.0	-0.9	200

MIX # 1	MIX # 2
% LOSS (%I)	6.73
% Pb BATCHED	5.71
CORRECTION	1.02
(Cf)	0.99

CERTIFIED TECHNICIAN (PLEASE PRINT) AND CARD NUMBER	COMPANY NAME	SIGNATURE	DATE
Scott Aker #43048	ODOT		10/10/2020
		<input checked="" type="checkbox"/> QUALITY CONTROL VERIFICATION INDEPENDENT ASSURANCE	

DAILY ASPHALT PLANT PRODUCTION

PROJECT NAME (SECTION)		CONTRACT NUMBER
CONTRACTOR OR SUPPLIER		PROJECT MANAGER
		REPORT NUMBER
		MATERIAL TYPE (ACP OR EAC)
		DATE

DAILY METER READINGS

A G G	PLANT DRY AGG BEGIN	WET AGG BEGIN	A
	PLANT DRY AGG END	WET AGG END	B
	PLANT SET AGG MOISTURE	AVERAGE COLD FEED MOISTURE	C
	(B-A)/(1+(C/100)) TOTAL DRY AGG		D
R A P / R A M	PLANT DRY RAP BEGIN	WET RAP BEGIN	E
	PLANT DRY RAP END	WET RAP END	F
	PLANT SET RAP MOISTURE	AVERAGE RAP MOISTURE	G
	(F-E)/(1+(G/100)) TOTAL DRY RAP		H
R A S	PLANT DRY RAS BEGIN	WET RAS BEGIN	I
	PLANT DRY RAS END	WET RAS END	J
	PLANT SET RAS MOISTURE	AVERAGE RAS MOISTURE	K
	(J-I)/(1+(K/100)) TOTAL DRY RAS		L
A S P H A L T	ASPHALT BEGIN correction	1.000	M
	ASPHALT END	1.000	N
	If correction used explain method.		
	(N-M) ASPHALT TOTAL		O
A N T I S T R I P	ANTISTRIP BEGIN correction	1.00	P CORRECTED
	ANTISTRIP DELIVERED	1.00	Q
	ANTISTRIP END	1.00	R
	R-P (meter) or P+Q-R (scales) ANTISTRIP TOTAL		S

DAILY PHYSICAL INVENTORY

A C P	TOTAL MIX ACCEPTED	a
	PLANT MIX WASTE (WEIGHED)	b
	REJECTED LOAD MIX WASTE	c
	MIX SOLD TO OTHERS	d
	TOTAL MIX NOT ACCEPTED b + c + d	e
	TOTAL ACP PRODUCED a + e	f
A S P H A L T	DAILY AVE MIX MOISTURE	g
	TANK STICK BEGIN	h
	ASPHALT DELIVERED	i
	DEDUCTIONS ASPHALT REMOVED PRIOR TO METERING	k
	TANK STICK END	m
	TOTAL BY TANK STICKING h + i - k - m	n
A N T I S T R I P	ANTISTRIP BEGIN INVENTORY	p
	ANTISTRIP DELIVERED	q
	ANTISTRIP END INVENTORY	r
	ANTISTRIP TOTAL p + q - r	s

V PHYSICAL TOTAL DRY MIX	ACP: $f / (1+(g/100))$	EAC: $f / (1+(C/100))$
W METERED TOTAL DRY MIX	ACP: $(D+H+L+O-U)$	EAC: $(D+O-U)$
Y BY METER % Pb	ACP: $(O/W) \times 100$	EAC: $(O/(W-O)) \times 100$
Z BY TANK % Pb	ACP: $(n/V) \times 100$	EAC: $(n/(V-n)) \times 100$
% ERROR ASPHALT METER vs. TANK MEASURE		$((n-O)/n) \times 100$

% ERROR TRUCK SCALE vs. TOTAL METER	ALLOWABLE $\pm 1.0\%$ (ACP)
ACP: $((V-W)/V) \times 100$	EAC: $(f-(B-A+O-U)/f) \times 100$
DAILY DIFFERENCE: TANK vs. METER Z - Y ALLOWABLE ± 0.20	

UNCOATED AGG WASTE (WEIGHED)		
% ANTISTRIP $(S/(D-S)) \times 100$	% RAS $(L/(D+H+L)) \times 100$	% RAM $((H+L)/(D+H+L)) \times 100$

QUALITY CONTROL	VERIFICATION	
CERTIFIED TECHNICIAN (PLEASE PRINT) AND CARD NUMBER	COMPANY NAME	SIGNATURE
		DATE

DAILY ASPHALT PLANT PRODUCTION

PROJECT NAME (SECTION) Forms Example		CONTRACT NUMBER 12345
CONTRACTOR OR SUPPLIER ODOT Forms		PROJECT MANAGER Sean Parker
		REPORT NUMBER 123
MATERIAL TYPE (ACP OR EAC) ACP		DATE 10/10/2017

DAILY METER READINGS

A G G	PLANT DRY AGG BEGIN	WET AGG BEGIN
	0.00	A 0.00
	PLANT DRY AGG END	WET AGG END
	825.60	B 841.29
R A P / R A M	PLANT SET AGG MOISTURE	AVERAGE COLD FEED MOISTURE
	1.9 <small>(B-A)/(1+(C/100))</small>	C 1.5
	TOTAL DRY AGG	D 828.86
	PLANT DRY RAP BEGIN	WET RAP BEGIN
0.00	E 0.00	
PLANT DRY RAP END	WET RAP END	
306.79	F 314.15	
PLANT SET RAP MOISTURE	AVERAGE RAP MOISTURE	
2.4 <small>(F-E)/(1+(G/100))</small>	G 2.3	
TOTAL DRY RAP	H 307.09	
R A S	PLANT DRY RAS BEGIN	WET RAS BEGIN
	0.00	I 0.00
	PLANT DRY RAS END	WET RAS END
	59.46	J 60.35
PLANT SET RAS MOISTURE	AVERAGE RAS MOISTURE	
1.5 <small>(J-I)/(1+(K/100))</small>	K 1.7	
TOTAL DRY RAS	L 59.34	
A S P H A L T	ASPHALT BEGIN <small>correction</small>	WET ASPHALT BEGIN
	0.00 1.000	M 0.00
	ASPHALT END	WET ASPHALT END
	58.59 1.000	N 58.59
If correction used explain method.		
<small>(N-M)</small>		
ASPHALT TOTAL		O 58.59
A N T I S T R I P	ANTISTRIP BEGIN <small>correction</small>	CORRECTED
	14.080 1.00	P 14.080
	ANTISTRIP DELIVERED	
	1.00	Q
ANTISTRIP END		
7.400 1.00	R 7.400	
<small>R-P (meter) or P+Q-R (scales)</small>		
ANTISTRIP TOTAL		S 6.680

DAILY PHYSICAL INVENTORY

A C P	TOTAL MIX ACCEPTED	a 1205.25
	PLANT MIX WASTE (WEIGHED)	b 36.11
	REJECTED LOAD MIX WASTE	c 10.00
	MIX SOLD TO OTHERS	d 0.00
	TOTAL MIX NOT ACCEPTED <small>b + c + d</small>	e 46.11
	TOTAL ACP PRODUCED <small>a + e</small>	f 1251.36
A S P H A L T	DAILY AVE MIX MOISTURE	g 0.25
	TANK STICK BEGIN	h 100.24
	ASPHALT DELIVERED	i 38.50
	DEDUCTIONS	k 0.00
	ASPHALT REMOVED PRIOR TO METERING TANK STICK END	m 79.64
	TOTAL BY TANK STICKING <small>h + i - k - m</small>	n 59.10
A N T I S T R I P	ANTISTRIP BEGIN INVENTORY	p 14.080
	ANTISTRIP DELIVERED	q 0.000
	ANTISTRIP END INVENTORY	r 7.400
	ANTISTRIP TOTAL <small>p + q - r</small>	s 6.680

V W Y Z	PHYSICAL TOTAL DRY MIX 1248.24	ACP: $f / (1+(g/100))$	EAC: $f / (1+(C/100))$
	METERED TOTAL DRY MIX 1242.77	ACP: $(D+H+L+O-U)$	EAC: $(D+O-U)$
	BY METER % Pb 4.71	ACP: $(O/W) \times 100$	EAC: $(O/(W-O)) \times 100$
	BY TANK % Pb 4.73	ACP: $(n/V) \times 100$	EAC: $(n/(V-n)) \times 100$
% ERROR ASPHALT METER vs. TANK MEASURE 0.86		$((n-O)/n) \times 100$	

% ERROR TRUCK SCALE vs. TOTAL METER 0.44	ALLOWABLE $\pm 1.0\%$ (ACP) ACP: $((V-W)/V) \times 100$	EAC: $(f-(B-A+O-U)/f) \times 100$
DAILY DIFFERENCE: TANK vs. METER 0.02	Z - Y	ALLOWABLE ± 0.20

U	UNCOATED AGG WASTE (WEIGHED) 11.11		
	% ANTISTRIP <small>(S/(D-S))x100</small>	% RAS <small>(L/(D+H+L))x100</small>	% RAM <small>((H+L)/(D+H+L))x100</small>
	0.81	5.0	30.7

<input checked="" type="checkbox"/> QUALITY CONTROL	<input type="checkbox"/> VERIFICATION	
CERTIFIED TECHNICIAN (PLEASE PRINT) AND CARD NUMBER Scott Aker # 43048	COMPANY NAME ODOT	SIGNATURE 10/10/2017

DAILY ASPHALT PLANT RECONCILIATION ACP

PROJECT NAME (SECTION)		CONTRACT NUMBER
CONTRACTOR OR SUPPLIER	PROJECT MANAGER	REPORT NUMBER
REMARKS		DATE

DAILY METER READINGS (Plant)

DAILY PHYSICAL INVENTORY (Truck Scale)

A G G	Begin Meter		M o i s t	Plant Set	A	Total Dry Aggregate <small>(End - Begin)X(1+plant set/100)/(1+avg/100)</small>	AC P	Truck Scale <small>(Including mix sold to others)</small>	G		
	End Meter			Avg Moist					Total ACP Mix Wasted	H	
R A M	Begin Meter		M o i s t	Plant Set	B	Total Dry RAM <small>(End - Begin)X(1+plant set/100)/(1+avg/100)</small>	AC P	Total Uncoated Agg Waste	I		
	End Meter			Avg Moist					Total ACP Mix Produced	J	<small>G + H</small>
A C	Begin Meter		M o i s t		C	Total Metered AC <small>End - Begin</small>	AC P	Average Daily ACP Mix Moisture	K	%	
	End Meter								Total Truck Scale (Dry)	L	
A N T R I P	Begin Meter		M o i s t		D	Total Antistrip <small>Begin + Deliveries - End</small>	AC P	<small>J / (1 + K / 100)</small>	L		
	Deliveries								Total Plant Meters vs. Truck Scale (Dry)	M	%
	End Meter								Allowable $\pm 1.0\%$ <small>((L - E) / L) X 100</small>		
Total Plant Dry Metered Materials					E	<small>A + B + C - I</small>	AC P	<small>% Antistrip D / (A-D) * 100</small>	<small>% RAM B / (B+A) * 100</small>		
Tank vs AC Meter (%) <small>(Q - C) / Q * 100</small>					F						

A S P H A L T I N V E N T O R Y	Beginning Tank Stick										
	Tank No.	Oil Temp	Tank Stick	Volume in Tank	Temperature Correction Factor	Binder Specific Gravity	/	239.9	=	Tons	
	1				X		X				
	2										
	3										
	Beginning Tank Stick Total									N	

Deliveries After Beginning Inventory										
Invoice No.	Tons	Invoice No.	Tons	Invoice No.	Tons	Invoice No.	Tons			
Total Deliveries									O	

A S P H A L T I N V E N T O R Y	Ending Tank Stick										
	Tank No.	Oil Temp	Tank Stick	Volume in Tank	Temperature Correction Factor	Binder Specific Gravity	/	239.9	=	Tons	
	1				X		X				
	2										
	3										
	Ending Tank Stick Total									P	

Total Daily Binder									Q	
--------------------	--	--	--	--	--	--	--	--	----------	--

QUALITY CONTROL	VERIFICATION	CERTIFIED TECHNICIAN (PLEASE PRINT) AND CARD NUMBER	COMPANY NAME	SIGNATURE	DATE
-----------------	--------------	---	--------------	-----------	------

DAILY ASPHALT PLANT RECONCILIATION ACP

PROJECT NAME (SECTION)		CONTRACT NUMBER
CONTRACTOR OR SUPPLIER	PROJECT MANAGER	REPORT NUMBER
REMARKS		DATE

DAILY METER READINGS (Plant)

DAILY PHYSICAL INVENTORY (Truck Scale)

AGG	Begin Meter	0.00	M o i s t	Plant Set	3.00	A	Total Dry Aggregate <small>(End - Begin)X(1+plant set/100)/(1+avg/100)</small>	ACP	Truck Scale <small>(Including mix sold to others)</small>	G	2025.01			
	End Meter	1396.30		Avg Moist	2.20				1407.23	Total ACP Mix Wasted	H	15.00		
RAM	Begin Meter	0.00	M o i s t	Plant Set	3.10	B	Total Dry RAM <small>(End - Begin)X(1+plant set/100)/(1+avg/100)</small>	ACP	Total Uncoated Agg Waste	I	15.00			
	End Meter	579.77		Avg Moist	3.10				579.77	Total ACP Mix Produced	G + H	J	2040.01	
AC	Begin Meter	0.00	ACP			C	Total Metered AC <small>End - Begin</small>	ACP	Average Daily ACP Mix Moisture	K	0.38 %			
	End Meter	80.65							80.65	Total Truck Scale (Dry)	L	2032.29		
ANTRI	Begin Meter	22.62	ACP			D	Total Antistrip <small>Begin + Deliveries - End</small>	ACP	Total Plant Meters vs. Truck Scale (Dry)	M	-1.0 %			
	Deliveries	20.06							ACP	Allowable $\pm 1.0\%$ <small>((L - E) / L) X 100</small>	ACP	% Antistrip <small>D / (A-D) * 100</small>	ACP	% RAM <small>B / (B+A) * 100</small>
	End Meter	30.02												
Total Plant Dry Metered Materials						A + B + C - I	E	2052.65						
Tank vs AC Meter (%)						(Q - C) / Q * 100	F	-2.3						

ASPHALT	Beginning Tank Stick											
	Tank No.	Oil Temp	Tank Stick	Volume in Tank	Temperature Correction Factor	Binder Specific Gravity	/	239.9	=	Tons		
	Binder Grade											
	1				X							
	PG 64-28	320	73.5	11768	0.9122	1.037		239.9		46.40		
	2											
	3											
	Beginning Tank Stick Total										N	46.40

INVENTORY	Deliveries After Beginning Inventory										
	Invoice No.	Tons	Invoice No.	Tons	Invoice No.	Tons	Invoice No.	Tons			
		32.76									
		33.07									
		30.21							O	96.04	

INVENTORY	Ending Tank Stick											
	Tank No.	Oil Temp	Tank Stick	Volume in Tank	Temperature Correction Factor	Binder Specific Gravity	/	239.9	=	Tons		
	Binder Grade											
	1				X							
	PG 64-28	320	59.5	16127	0.9122	1.037		239.9		63.59		
	2											
	3											
	Ending Tank Stick Total										P	63.59

Total Daily Binder										N + O - P	Q	78.85
--------------------	--	--	--	--	--	--	--	--	--	-----------	---	-------

QUALITY CONTROL	VERIFICATION	CERTIFIED TECHNICIAN (PLEASE PRINT) AND CARD NUMBER		COMPANY NAME	SIGNATURE	DATE
-----------------	--------------	---	--	--------------	-----------	------

CAT II - JMF TARGET ADJUSTMENT SUMMARY

E

English (E) or Metric (M)

PROJECT NAME (SECTION)				CONTRACT NUMBER				
CONTRACTOR OR SUPPLIER			PROJECT MANAGER				BID ITEM NUMBER	
CERTIFIED TECHNICIAN CAT II & CARD #		MIX DESIGN		MATERIAL DESCRIPTION			TO BE USED IN	

ADJUSTMENT #	JMF Va		EXPECTED Va		JMF VFA		EXPECTED VFA		JMF VMA		EXPECTED VMA	
	Pb	1"	3/4"	1/2"	3/8"	#4	#8	#16	#30	#50	#100	#200
CONSTITUENT												
TARGET												
ADJUSTMENT												
SUBLOT	JUSTIFICATION / REMARKS:											
ADJUSTMENT DATE												
CERTIFIED CAT II SIGNATURE										DATE		

ADJUSTMENT #	JMF Va		EXPECTED Va		JMF VFA		EXPECTED VFA		JMF VMA		EXPECTED VMA	
	Pb	1"	3/4"	1/2"	3/8"	#4	#8	#16	#30	#50	#100	#200
CONSTITUENT												
TARGET												
ADJUSTMENT												
SUBLOT	JUSTIFICATION / REMARKS:											
ADJUSTMENT DATE												
CERTIFIED CAT II SIGNATURE										DATE		

ADJUSTMENT #	JMF Va		EXPECTED Va		JMF VFA		EXPECTED VFA		JMF VMA		EXPECTED VMA	
	Pb	1"	3/4"	1/2"	3/8"	#4	#8	#16	#30	#50	#100	#200
CONSTITUENT												
TARGET												
ADJUSTMENT												
SUBLOT	JUSTIFICATION / REMARKS:											
ADJUSTMENT DATE												
CERTIFIED CAT II SIGNATURE										DATE		

ADJUSTMENT #	JMF Va		EXPECTED Va		JMF VFA		EXPECTED VFA		JMF VMA		EXPECTED VMA	
	Pb	1"	3/4"	1/2"	3/8"	#4	#8	#16	#30	#50	#100	#200
CONSTITUENT												
TARGET												
ADJUSTMENT												
SUBLOT	JUSTIFICATION / REMARKS:											
ADJUSTMENT DATE												
CERTIFIED CAT II SIGNATURE										DATE		

CAT II - JMF TARGET ADJUSTMENT SUMMARY

E

English (E) or Metric (M)

PROJECT NAME (SECTION) Forms Example								CONTRACT NUMBER 12345			
CONTRACTOR OR SUPPLIER ODOT Forms				PROJECT MANAGER Sean Parker				BID ITEM NUMBER 123			
CERTIFIED TECHNICIAN CAT II & CARD # Scott Aker #43048		MIX DESIGN 08-MD0000		MATERIAL DESCRIPTION L3 1/2" Dense HMAC			TO BE USED IN Base / Wearing				

ADJUSTMENT #	JMF Va		EXPECTED Va		JMF VFA		EXPECTED VFA		JMF VMA		EXPECTED VMA	
1	4.0		4.8		74		67		15.4		14.5	
CONSTITUENT	Pb	1"	3/4"	1/2"	3/8"	#4	#8	#16	#30	#50	#100	#200
TARGET	5.30	---	100	98	84	56	38	25	14	11	8	5.0
ADJUSTMENT							35					
SUBLOT 1-5	JUSTIFICATION / REMARKS: Running average of 4 shows VMA out of tolerance at 13.4, Pb = 5.32, P#8 = 38%, P#200 = 4.9%, and Va = 4.6%. Proposed blend change for #8 to 35% to increase VMA. Will need to check voids after blend change.											
ADJUSTMENT DATE 10/9/12												
CERTIFIED CAT II SIGNATURE										DATE		

ADJUSTMENT #	JMF Va		EXPECTED Va		JMF VFA		EXPECTED VFA		JMF VMA		EXPECTED VMA	
2	4.0		4.1		74		72		15.4		14.8	
CONSTITUENT	Pb	1"	3/4"	1/2"	3/8"	#4	#8	#16	#30	#50	#100	#200
TARGET	5.30	---	100	98	84	53	35	25	14	11	8	5.0
ADJUSTMENT	5.50											
SUBLOT 1-7	JUSTIFICATION / REMARKS: Blend change on subplot 1-5 brought VMA within tolerance however running average of 4 after sublots 1-5 and 1-6 shows Va at 5.0. Propose Pb target change to 5.50											
ADJUSTMENT DATE 10/10/12												
CERTIFIED CAT II SIGNATURE										DATE		

ADJUSTMENT #	JMF Va		EXPECTED Va		JMF VFA		EXPECTED VFA		JMF VMA		EXPECTED VMA	
CONSTITUENT	Pb	1"	3/4"	1/2"	3/8"	#4	#8	#16	#30	#50	#100	#200
TARGET												
ADJUSTMENT												
SUBLOT	JUSTIFICATION / REMARKS:											
ADJUSTMENT DATE												
CERTIFIED CAT II SIGNATURE										DATE		

ADJUSTMENT #	JMF Va		EXPECTED Va		JMF VFA		EXPECTED VFA		JMF VMA		EXPECTED VMA	
CONSTITUENT	Pb	1"	3/4"	1/2"	3/8"	#4	#8	#16	#30	#50	#100	#200
TARGET												
ADJUSTMENT												
SUBLOT	JUSTIFICATION / REMARKS:											
ADJUSTMENT DATE												
CERTIFIED CAT II SIGNATURE										DATE		

MAXIMUM DENSITY OF CONSTRUCTION MATERIALS

E English (E) or Metric (M)

PROJECT NAME (SECTION)				CONTRACT NUMBER	
CONTRACTOR OR SUPPLIER			PROJECT MANAGER		BID ITEM NUMBER
SOURCE NAME			SOURCE NUMBER		MATERIAL SIZE
TEST NO.	DATE	TIME	SAMPLED AT	MATERIAL DESCRIPTION	TO BE USED IN

lb/ft³							
lb/ft³							
lb/ft³							
lb/ft³							
lb/ft³							
%	%	%	%	%	%	%	%

TEST METHOD
T 99 **T 180**

A or D

SAMPLE

+ No4	
- No4	
Total Pc	%
+ 3/4	
- 3/4	
Total Pc	%

MAX DRY DENSITY OF THE FINES
 ρ_f lb/ft³

OPTIMUM MOISTURE OF THE FINES
MCf %

TEST NO.	MASS OF MOLD AND MATERIALS (GRAMS)	MASS OF MOLD (GRAMS)	(M) MASS OF WET MATERIAL	WET DENSITY WD = (M)x(MF) lb/ft³	OVEN MOISTURE % AASHTO T255 / 265				(D) DRY DENSITY lb/ft³	MOLD FACTOR (MF)
					Pan Tare (t)	WET(a)	DRY(b)	% M (m)		
1										4 in MOLD = 0.06614 101.6mm MOLD = 1.060 6 in MOLD = 0.02939 152.4mm = 0.471
2										
3										
4										
5										OVEN MOISTURE % (a) - (b) (m) = $\frac{(b) - (t)}{(a) - (b)}$ X100
6										
7										(WD) (D) = $\frac{(WD)}{(m)+100}$ X100
8										

AASHTO T85	Oven Dry Mass	SSD Mass	Weight in Water	Gsb	Gsb SSD	Gsa	ABSORPTION
SPECIFIC GRAVITY OF COARSE AGGREGATE	(A)	(B)	(C)	(A) / [(B)-(C)]	(B) / [(B)-(C)]	(A) / [(A)-(C)]	(((B)-(A))/((A)))X100

COMMENTS

<input type="checkbox"/> QUALITY CONTROL	<input type="checkbox"/> INDEPENDENT ASSURANCE
CERTIFIED TECHNICIAN (PLEASE PRINT) AND CARD NUMBER	COMPANY NAME
SIGNATURE	DATE

MAXIMUM DENSITY OF CONSTRUCTION MATERIALS

PROJECT NAME (SECTION)				CONTRACT NUMBER	
CONTRACTOR OR SUPPLIER			PROJECT MANAGER		BID ITEM NUMBER
SOURCE NAME			SOURCE NUMBER		MATERIAL SIZE
TEST NO.	DATE	TIME	SAMPLED AT	MATERIAL DESCRIPTION	TO BE USED IN

AASHTO T 99 COARSE PARTICLE CORRECTION

RELATIVE MAXIMUM DRY DENSITY $100 / (Pf / pf) + (Pc / k) = \rho_d$
COMBINED OPTIMUM MOISTURE $(MCf \times Pf + MCc \times Pc) / 100 = MCT$
Pf = 100 - Pc k = Gsb x 62.4 MCc = ABSORPTION OR MOISTURE

COARSE PARTICLES
 RELATIVE MAXIMUM DRY DENSITY
 COMBINED OPTIMUM MOISTURE
 COARSE PARTICLES

0-9%			0-9%
10%			10%
11%			11%
12%			12%
13%			13%
14%			14%
15%			15%
16%			16%
17%			17%
18%			18%
19%			19%
20%			20%
21%			21%
22%			22%
23%			23%
24%			24%
25%			25%
26%			26%
27%			27%
28%			28%
29%			29%
30%			30%
31%			31%
32%			32%
33%			33%
34%			34%
35%			35%
36%			36%
37%			37%
38%			38%
39%			39%
40%			40%

TEST METHOD

T 99 T 180

A or D

CURVE COARSE PARTICLES

+ No4 %

+ 3/4 %

SOILS

MAX DRY DENSITY OF THE FINES

ρ_f lb/ft³

OPTIMUM MOISTURE % THE FINES

MCf %

MAX DRY DENSITY OF THE COURSE

k lb/ft³

OPTIMUM MOISTURE % THE COURSE

MCc %

<input type="checkbox"/> QUALITY CONTROL	<input type="checkbox"/> VERIFICATION		
CERTIFIED TECHNICAN (PLEASE PRINT) AND CARD NUMBER		COMPANY NAME	SIGNATURE DATE

MAXIMUM DENSITY OF CONSTRUCTION MATERIALS

E English (E) or Metric (M)

PROJECT NAME (SECTION) Forms Example				CONTRACT NUMBER 12345	
CONTRACTOR OR SUPPLIER ODOT Forms			PROJECT MANAGER Sean Parker		BID ITEM NUMBER 123
SOURCE NAME Native			SOURCE NUMBER n/a		MATERIAL SIZE 1"-0
TEST NO. 1	DATE 10/9/2020	TIME 8:00am	SAMPLED AT 15+45	MATERIAL DESCRIPTION Lt Brown Silty Clay	TO BE USED IN Embankment

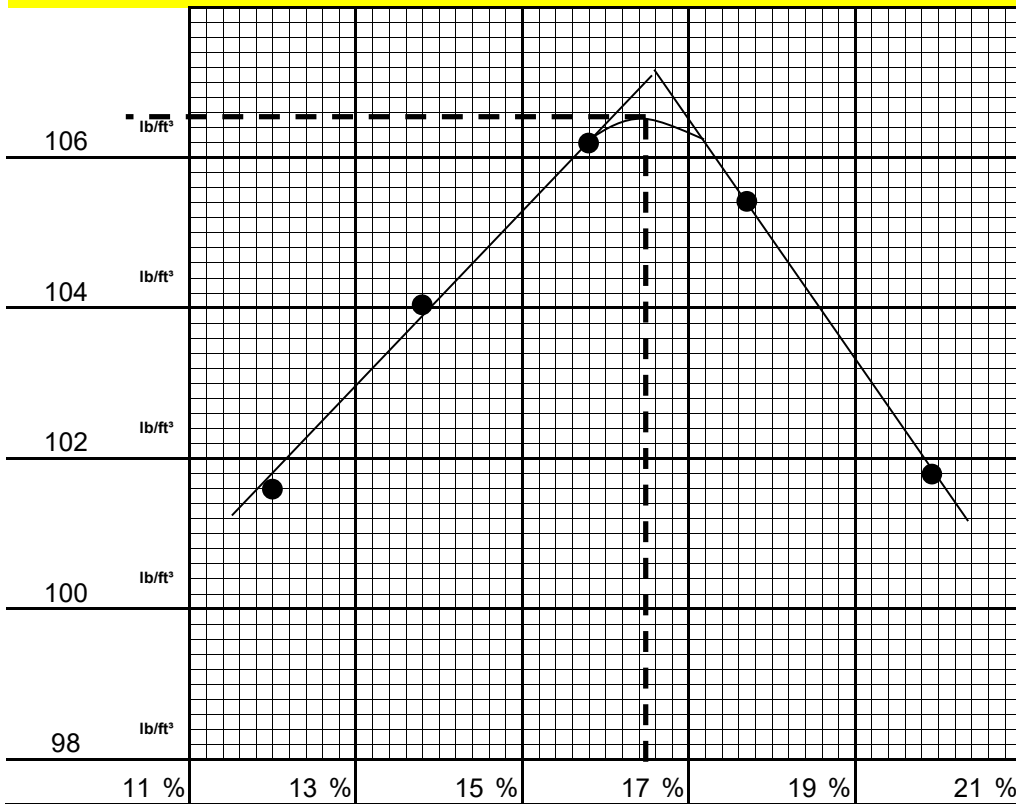

TEST METHOD
 T 99 T 180
 A or D **A**

SAMPLE

+ No4	4098.1
- No4	9231.6
Total	13329.7
Pc	31 %
+ 3/4	1533.4
- 3/4	11796.3
Total	13329.7
Pc	12 %

MAX DRY DENSITY OF THE FINES
 ρ_f **106.5** lb/ft³

OPTIMUM MOISTURE OF THE FINES
 MC_f **16.5** %

TEST NO.	MASS OF MOLD AND MATERIALS (GRAMS)	MASS OF MOLD (GRAMS)	(M) MASS OF WET MATERIAL	WET DENSITY WD = (M)x(MF) lb/ft³	OVEN MOISTURE % AASHTO T255 / 265				(D) DRY DENSITY lb/ft³	MOLD FACTOR (MF) 0.06614
					Pan Tare (t)	WET(a)	DRY(b)	% M (m)		
1	5964.80	4244.1	1720.70	113.8	130.2	358.4	334.0	12.0	101.6	4 in MOLD = 0.06614 101.6mm MOLD = 1.060 6 in MOLD = 0.02939 152.4mm = 0.471
2	6032.50	4244.1	1788.40	118.3	127.9	361.8	333.4	13.8	104	
3	6104.20	4244.1	1860.10	123	128.5	382.0	347.4	15.8	106.2	
4	6118.70	4244.1	1874.60	124	128.2	376.7	339.4	17.7	105.4	
5	6090.50	4244.1	1846.40	122.1	129.5	372.2	331.9	19.9	101.8	OVEN MOISTURE % (m) = $\frac{(a) - (b)}{(b) - (t)} \times 100$ (D) = $\frac{(WD)}{(m) + 100} \times 100$
6										
7										
8										

AASHTO T85	Oven Dry Mass (A)	SSD Mass (B)	Weight in Water (C)	Gsb (A) / [(B)-(C)]	Gsb SSD (B) / [(B)-(C)]	Gsa (A) / [(A)-(C)]	ABSORPTION [(B)-(A)]/(A)x100
SPECIFIC GRAVITY OF COARSE AGGREGATE	4001.7	4073.1	2498.4	2.541	2.587	2.662	1.8

COMMENTS

QUALITY CONTROL INDEPENDENT ASSURANCE

CERTIFIED TECHNICIAN (PLEASE PRINT) AND CARD NUMBER Scott Aker #43048	COMPANY NAME ODOT	SIGNATURE <i>Scott Aker</i>	DATE 10/9/20
---	-----------------------------	--------------------------------	------------------------

MAXIMUM DENSITY OF CONSTRUCTION MATERIALS

PROJECT NAME (SECTION) Forms Example				CONTRACT NUMBER 12345	
CONTRACTOR OR SUPPLIER ODOT Forms			PROJECT MANAGER Sean Parker		BID ITEM NUMBER 123
SOURCE NAME Native			SOURCE NUMBER n/a		MATERIAL SIZE 1"-0
TEST NO. 1	DATE 10/9/2020	TIME 8:00am	SAMPLED AT 15+45	MATERIAL DESCRIPTION Lt Brown Silty Clay	TO BE USED IN Embankment

AASHTO T 99 COARSE PARTICLE CORRECTION

RELATIVE MAXIMUM DRY DENSITY 100 / (Pf / pf) + (Pc / k) = P_d
COMBINED OPTIMUM MOISTURE (MC_f x Pf + MC_c x Pc) / 100 = MCT
Pf = 100 - Pc k = Gsb x 62.4
MC _c = ABSORPTION OR MOISTURE

COARSE PARTICLES

RELATIVE MAXIMUM DRY DENSITY

COMBINED OPTIMUM MOISTURE

COARSE PARTICLES

0-9%	106.5	16.5	0-9%
10%	110.1	15.0	10%
11%	110.5	14.9	11%
12%	110.9	14.7	12%
13%	111.3	14.6	13%
14%	111.6	14.4	14%
15%	112	14.3	15%
16%	112.4	14.1	16%
17%	112.8	14.0	17%
18%	113.2	13.9	18%
19%	113.6	13.7	19%
20%	114	13.6	20%
21%	114.4	13.4	21%
22%	114.8	13.3	22%
23%	115.2	13.1	23%
24%	115.6	13.0	24%
25%	116	12.8	25%
26%	116.4	12.7	26%
27%	116.9	12.5	27%
28%	117.3	12.4	28%
29%	117.7	12.2	29%
30%	118.1	12.1	30%
31%	118.6	11.9	31%
32%	119	11.8	32%
33%	119.4	11.6	33%
34%	119.9	11.5	34%
35%	120.3	11.4	35%
36%	120.8	11.2	36%
37%	121.2	11.1	37%
38%	121.7	10.9	38%
39%	122.1	10.8	39%
40%	122.6	10.6	40%

TEST METHOD

T 99 T 180

A or D A

CURVE COARSE PARTICLES

+ No4 %

+ 3/4 %

SOILS

MAX DRY DENSITY OF THE FINES

P_f lb/ft³

OPTIMUM MOISTURE % THE FINES

MC_f %

MAX DRY DENSITY OF THE COURSE

k lb/ft³

OPTIMUM MOISTURE % THE COURSE

MC_c %

<input checked="" type="checkbox"/> QUALITY CONTROL	<input type="checkbox"/> VERIFICATION		
CERTIFIED TECHNICAN (PLEASE PRINT) AND CARD NUMBER Scott Aker #43048	COMPANY NAME ODOT	SIGNATURE Aker	DATE 10/9/20

MAXIMUM DENSITY OF AGGREGATE BASE MATERIALS E English (E) or Metric (M)

PROJECT NAME (SECTION) <div style="text-align: center;">Forms Example</div>				CONTRACT NUMBER 12345	
CONTRACTOR OR SUPPLIER ODOT Forms			PROJECT MANAGER Sean Parker		BID ITEM NUMBER 123
SOURCE NAME Best Rock Quarry			SOURCE NUMBER 10-123-3		MATERIAL SIZE 1"-0
TEST NO. 1	DATE 10/9/2020	TIME 8:00am	SAMPLED AT Final Belt	MATERIAL DESCRIPTION Crushed Aggregate	TO BE USED IN Aggregate Base

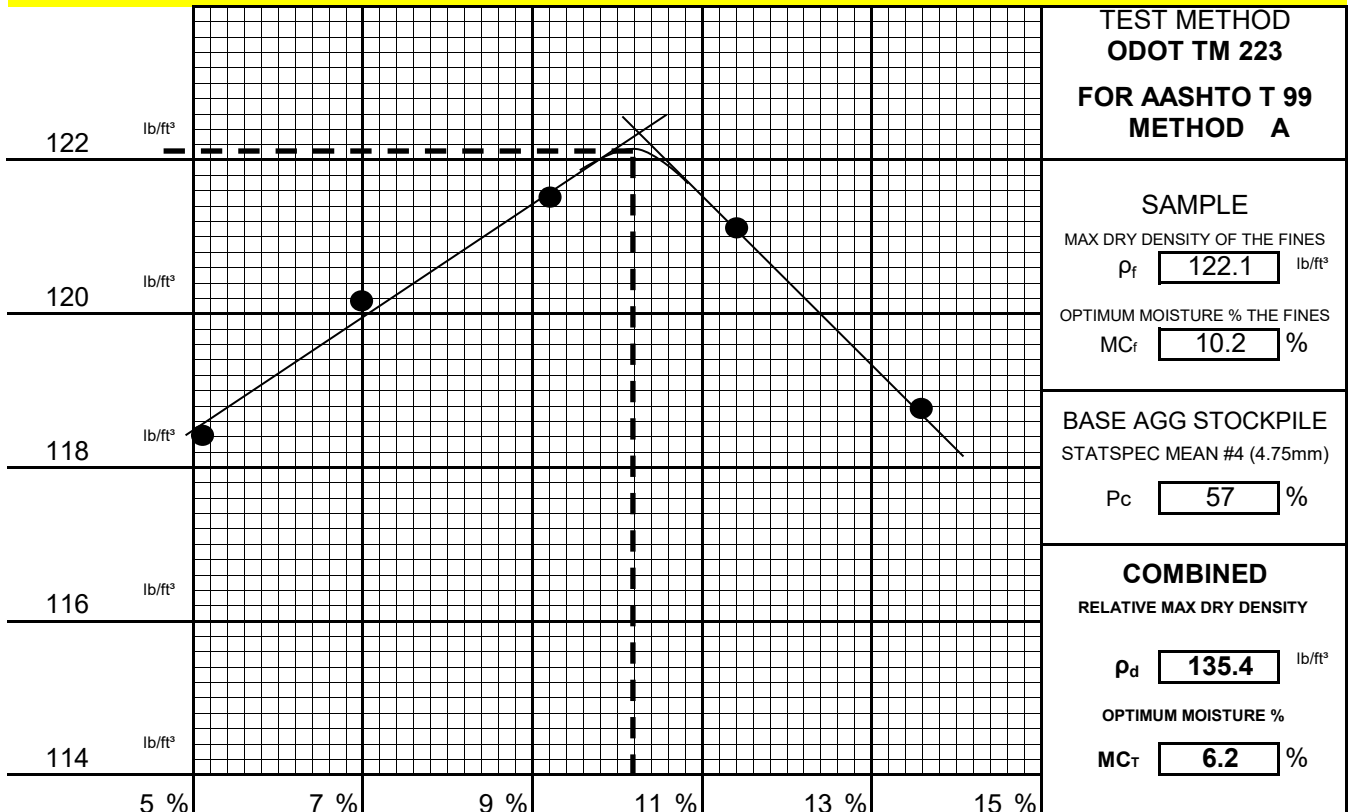

TEST NO.	MASS OF MOLD AND MATERIALS (grams)	MASS OF MOLD (grams)	(M) MASS OF WET MATERIAL	(WD) WET DENSITY lb/ft ³	OVEN MOISTURE % AASHTO T255 / 265				(D) DRY DENSITY lb/ft ³
					Pan Tare (t)	WET(a)	DRY(b)	% M (m)	
1	6125.2	4244.1	1881.1	124.4	100.1	638.2	612.1	5.1	118.4
2	6188.4	4244.1	1944.3	128.6	99.9	660.2	623.5	7.0	120.2
3	6250.5	4244.1	2006.4	132.7	100.3	736.0	682.4	9.2	121.5
4	6284.3	4244.1	2040.2	134.9	100.5	668.0	609.9	11.4	121.1
5	6284.2	4244.1	2040.1	134.9	100.2	686.0	615.9	13.6	118.8
6									
7									
8									

MOLD FACTOR
0.06614

4" MOLD = 0.06614
101.6mm MOLD = 1.060
WD = (M) x MOLD FACTOR

OVEN MOISTURE %
(m) = $\frac{(a) - (b)}{(b) - (t)} \times 100$
(D) = $\frac{(WD)}{(m) + 100} \times 100$

AASHTO T85

SPECIFIC GRAVITY OF COARSE AGGREGATE

Oven Dry Mass (A)	SSD Mass (B)	Weight in Water (C)	Gsb (A) / [(B)-(C)]	Gsb SSD (B) / [(B)-(C)]	Gsa (A) / [(A)-(C)]	ABSORPTION [(B)-(A)] / (A) x 100
4562.3	4701.9	2964.3	2.626	2.706	2.855	3.1

ODOT TM 223

COARSE PARTICLE CORRECTION $P_r = 100 - P_c$ $k = Gsb \times 62.4$ $MC_c = \text{ABSORPTION OR MOISTURE}$

$$100 / ((P_f / \rho_f) + (P_c / (k \times 0.9))) = \rho_d$$

$$((MC_f \times P_f) + (MC_c \times P_c)) / 100 = MC_T$$

$$100 / ((\frac{43}{122.1}) + (\frac{57}{147.5})) = \rho_d$$

$$100 / ((\frac{0.35217}{122.1}) + (\frac{0.38644}{147.5})) = \mathbf{135.4}$$

$$((\frac{10.2}{100} \times 43) + (\frac{3.1}{100} \times 57)) / 100 = MC_T$$

$$((\frac{4.386}{100}) + (\frac{1.767}{100})) / 100 = \mathbf{6.2}$$

<input checked="" type="checkbox"/> QUALITY CONTROL	<input type="checkbox"/> INDEPENDENT ASSURANCE
CERTIFIED TECHNICIAN (PLEASE PRINT) AND CARD NUMBER Scott Aker #43048	COMPANY NAME ODOT
SIGNATURE Scott Aker	DATE 10/9/2020

FAMILY OF CURVES

E English (E) Metric (M)

PROJECT NAME (SECTION) <div style="text-align: center;">Forms Example</div>		CONTRACT NUMBER <div style="text-align: center;">12345</div>
CONTRACTOR OR SUPPLIER <div style="text-align: center;">ODOT Forms</div>	PROJECT MANAGER <div style="text-align: center;">Sean Parker</div>	BID ITEM NUMBER <div style="text-align: center;">123</div>

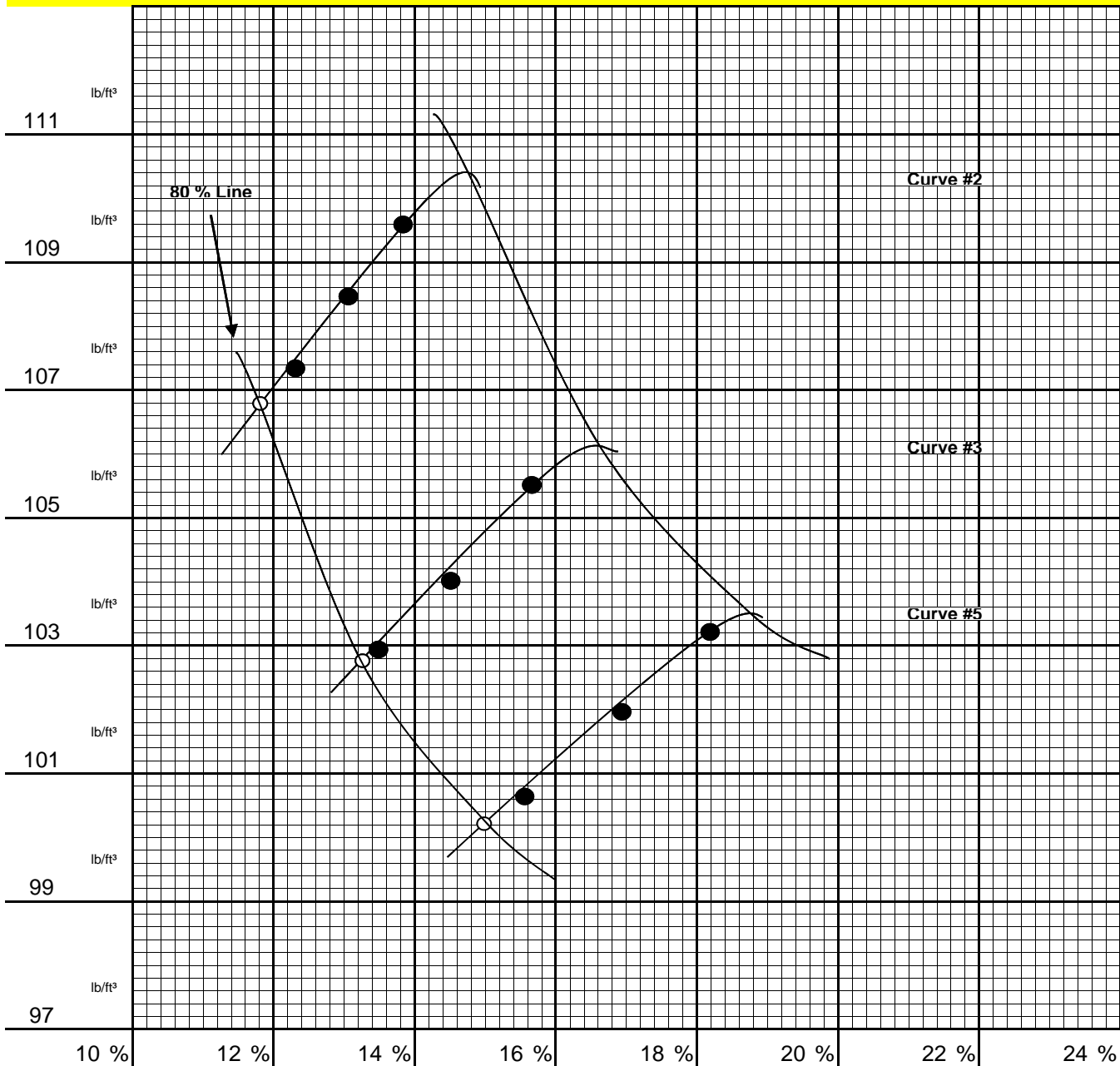

AASHTO T-99 Method A Method D

Coarse-Grained Sandy-Gravel <input checked="" type="checkbox"/> Silty-Gravel <input type="checkbox"/> Clayey-Gravel <input type="checkbox"/>	Fine-Grained Sand <input type="checkbox"/> Silt <input type="checkbox"/> Clay <input type="checkbox"/>	Color Light Brown <input type="checkbox"/> Med Brown <input checked="" type="checkbox"/> Dark Brown <input type="checkbox"/> Redish Brown <input type="checkbox"/>	Comments:
--	--	---	--------------------------

CERTIFIED TECHNICAN (PLEASE PRINT) AND CARD NUMBER <div style="text-align: center;">Scott Aker #43048</div>	COMPANY NAME <div style="text-align: center;">ODOT</div>	SIGNATURE <div style="text-align: center;"> </div>	DATE <div style="text-align: center;">10/10/2012</div>
--	---	---	---

CONCRETE YIELD AND W/C RATIO WORKSHEET

E

English (E) or Metric (M)

PROJECT NAME (SECTION)					CONTRACT NUMBER	
CONTRACTOR			PROJECT MANAGER		BID ITEM NUMBER	
CONCRETE SUPPLIER			SUBMITTED BY		QUANTITY REPRESENTED yd ³	
CONCRETE FOR USE IN (LOCATION OR PLACEMENT)			BRIDGE NUMBER		SPECIFIED STRENGTH PSI DAYS	
DATA SHEET NUMBER	SET NUMBER	DATE	INVOICE NUMBER	BATCH SIZE	TRUCK NO & DRIVER	

CONCRETE BATCH TICKET AND FIELD TEST DATA

CEMENTITIOUS MATERIAL		AGGREGATES		AGG % FREE MOISTURE	
CEMENT _____ lb	#1 _____ lb	_____ lb	_____ %		
SLAG _____ lb	#2 _____ lb	_____ lb	_____ %		
FLYASH _____ lb	#3 _____ lb	_____ lb	_____ %		
SILICA FUME _____ lb	FINE AGG (SAND) #4 _____ lb	_____ lb	_____ %		
TOTAL CEMENT _____ lb	TOTAL AGG _____ lb				
ADMIXTURES		1 _____ OZ			
		2 _____ OZ			
ADD WATER		3 _____ OZ			
BATCHED _____ lb	4 _____ OZ				
JOBSITE _____ lb	TOTAL ADMIXTURES _____ OZ				
TOTAL WATER _____ lb	TOTAL ADMIXTURES _____ lb				

CONVERSIONS

WATER

Gal x 8.34 = lb

L = kg

Admixtures

oz / 16 = lb

ml / 1000 = kg

TOTAL BATCH MASS _____ lb	AMBIENT _____ °F	SLUMP _____ in
	CONCRETE _____ °F	AIR _____ %

DENSITY

CONCRETE + POT _____ lb			
- POT MASS _____ lb			
CONCRETE MASS= _____ lb	÷ POT CALIBRATION _____	=	_____ lb/ft ³

YIELD _____	TOTAL BATCH MASS _____	=	_____	
	lb/ft ³ x 27 _____	=	_____	yd ³

CEMENT _____	CEMENT, FLYASH & SILICA _____	=	_____	
CONTENT _____	YIELD _____	=	_____	lb/yd ³

WATER CEMENT RATIO

A. AGGREGATE FREE WATER (FREE MOISTURE FACTOR = % FREE MOISTURE DIVIDED BY 100. EG. : 5.5% = 0.055)

BATCH MASS -	$\left(\frac{\text{BATCH MASS}}{(1 + \text{FREE MOISTURE FACTOR})} \right)$	= AGG. FREE WATER	W/C RATIO =	$\frac{\text{TOTAL FREE WATER (A+B+C)}}{\text{TOTAL CEMENT \& FLYASH}}$
#1 _____	- (_____ / 1+ _____)	= _____		lb
#2 _____	- (_____ / 1+ _____)	= _____		lb
#3 _____	- (_____ / 1+ _____)	= _____		lb
FINE AGG (SAND) #4 _____	- (_____ / 1+ _____)	= _____		lb
	A. AGGREGATE FREE WATER TOTAL	= _____		lb
_____ lb	=	_____	B. WATER ADDED AT PLANT&JOBSITE	= _____ lb
_____ lb	=	_____	C. ADMIXTURES ADDED	= _____ lb

<input type="checkbox"/> QUALITY CONTROL	<input type="checkbox"/> VERIFICATION		
CERTIFIED TECHNICIAN (PLEASE PRINT) AND CARD NUMBER	COMPANY NAME	SIGNATURE	DATE

CONCRETE YIELD AND W/C RATIO WORKSHEET

 E

English (E) or Metric (M)

PROJECT NAME (SECTION) Forms Example					CONTRACT NUMBER 12345	
CONTRACTOR ODOT Forms			PROJECT MANAGER Sean Parker		BID ITEM NUMBER 123	
CONCRETE SUPPLIER The Best Ready Mix			SUBMITTED BY Scott Aker		QUANTITY REPRESENTED 150 yd³	
CONCRETE FOR USE IN (LOCATION OR PLACEMENT) Deck			BRIDGE NUMBER 1234a		SPECIFIED STRENGTH 5000 PSI 28 DAYS	
DATA SHEET NUMBER F-43048-001	SET NUMBER 1	DATE 10/10/12	INVOICE NUMBER 123456	BATCH SIZE 9.00yd3	TRUCK NO & DRIVER #21 T. Driver	

CONCRETE BATCH TICKET AND FIELD TEST DATA

CEMENTITIOUS MATERIAL		AGGREGATES		AGG % FREE MOISTURE	
CEMENT	<u>4735</u> lb	3/4" Round #1	<u>17600</u> lb	<u>0.30</u>	%
SLAG	<u>165</u> lb	#2	_____ lb	_____	%
FLYASH	<u>2000</u> lb	#3	_____ lb	_____	%
SILICA FUME	<u>288</u> lb	FINE AGG (SAND) #4	<u>10080</u> lb	<u>7.90</u>	%
TOTAL CEMENT	<u>7188</u> lb	TOTAL AGG	<u>27680</u> lb		
AD MIXTURES		Rheobuild	<u>1</u> <u>580</u> oz		
		997	<u>2</u> <u>512</u> oz		
		AE-90	<u>3</u> <u>64</u> oz		
		_____	<u>4</u> _____ oz		
ADD WATER		TOTAL ADMIXTURES	<u>1156</u> oz		
BATCHED	<u>1186</u> lb	TOTAL ADMIXTURES	<u>72</u> lb		
JOBSITE	<u>0</u> lb				
TOTAL WATER	<u>1186</u> lb				
TOTAL BATCH MASS		AMBIENT	<u>40.5</u> °F	SLUMP	<u>6 1/2</u> in
<u>36126</u> lb		CONCRETE	<u>60.5</u> °F	AIR	<u>4.9</u> %

CONVERSIONS
WATER
Gal x 8.34 = lb
L = kg
Admixtures
oz / 16 = lb
ml / 1000 = kg

DENSITY

CONCRETE + POT	<u>43.90</u> lb			
- POT MASS	<u>7.68</u> lb			
CONCRETE MASS=	<u>36.22</u> lb	÷ POT CALIBRATION	<u>0.249900</u> =	<u>144.9</u> lb/ft³
YIELD	TOTAL BATCH MASS	=	<u>36126</u>	
	lb/ft ³ x 27	=	<u>3912.30</u>	= <u>9.23</u> yd³
CEMENT	CEMENT, FLYASH & SILICA	=	<u>7188</u>	
CONTENT	YIELD	=	<u>9.23</u>	= <u>779</u> lb/yd³

WATER CEMENT RATIO

A. AGGREGATE FREE WATER (FREE MOISTURE FACTOR = % FREE MOISTURE DIVIDED BY 100. EG.: 5.5% = 0.055)

BATCH MASS -	$\left(\frac{\text{BATCH MASS}}{(1 + \text{FREE MOISTURE FACTOR})} \right)$	= AGG. FREE WATER	W/C RATIO =	$\frac{\text{TOTAL FREE WATER (A+B+C)}}{\text{TOTAL CEMENT \& FLYASH}}$
3/4" Round #1	<u>17600</u> - (<u>17600</u> / 1+ <u>0.0030</u>) =	<u>53</u> lb		
#2	- (_____ / 1+ _____) =	_____ lb		
#3	- (_____ / 1+ _____) =	_____ lb		
FINE AGG (SAND) #4	<u>10080</u> - (<u>10080</u> / 1+ <u>0.0790</u>) =	<u>738</u> lb		
		A. AGGREGATE FREE WATER TOTAL =	<u>791</u> lb	
<u>2049</u> lb	= <u>0.29</u> = W/C RATIO	B. WATER ADDED AT PLANT&JOBSITE =	<u>1186</u> lb	
<u>7188</u> lb		C. ADMIXTURES ADDED =	<u>72</u> lb	

<input type="checkbox"/> QUALITY CONTROL	<input checked="" type="checkbox"/> VERIFICATION		
CERTIFIED TECHNICIAN (PLEASE PRINT) AND CARD NUMBER	COMPANY NAME	SIGNATURE	DATE
Scott Aker #43048	ODOT		10/10/2012

SAMPLE DATA SHEET

LABORATORY REPORT NUMBER	
* CON NO. & EA	* DATA SHEET NUMBER F - -
PROJECT NAME (SECTION)	CONTRACT NUMBER
CONTRACTOR OR SUPPLIER	PROJECT MANAGER
	CREW NUMBER

COMPLETE THIS SECTION FOR ALL SAMPLES One Data Sheet Per Asphalt Cement Type or Aggregate Size

* MATERIAL (DESCRIPTION, SIZE, GRADE, BRAND)		* USE OF MATERIAL	
* SOURCE OF MATERIAL (MANUFACTURER, SUPPLIER, OR SOURCE NO. & NAME FOR NATURAL MATERIALS)		SAMPLED AT (LOCATION OR STATION NUMBERS)	
NUMBER OF SAMPLES (BAGS, BOXES, OTHER)	QUANTITY REPRESENTED BY SAMPLE	DATE SAMPLED	
* CLASS OF SAMPLE			DATE SHIPPED
<input type="checkbox"/> QUALITY CONTROL	<input type="checkbox"/> VERIFICATION	<input type="checkbox"/> THIRD PARTY	
<input type="checkbox"/> SOURCE/PRODUCT COMPLIANCE	<input type="checkbox"/> OTHER (SPECIFY IN REMARKS)		BID ITEM NUMBER
* FIELD TESTED OR SUBMITTED BY (PRINT NAME)		SIGNATURE	
COMPANY NAME			
STREET ADDRESS		CREW NUMBER	
CITY, STATE AND ZIP CODE		* PHONE NUMBER	
* PROJECT CONTACT PERSON		* CONTACT PHONE NUMBER	

* ACP MIX DESIGN no.	REMARKS / SPECIAL REQUIREMENTS
ODOT LAB/JMF#	
CONTRACTOR MIX #	
ASPHALT CEMENT	
** Lot & Sublot	
** Date	

Note: * Required information. If information is missing, testing will be delayed.
 ** Additional information required for Asphalt Cement samples.

SAMPLE DATA SHEET

LABORATORY REPORT NUMBER

* CON NO. & EA CON01111	* DATA SHEET NUMBER F - 43048 - 001	
PROJECT NAME (SECTION) Form Example		CONTRACT NUMBER 12345
CONTRACTOR OR SUPPLIER ODOT Forms	PROJECT MANAGER Sean Parker	CREW NUMBER 1234

COMPLETE THIS SECTION FOR ALL SAMPLES One Data Sheet Per Asphalt Cement Type or Aggregate Size

* MATERIAL (DESCRIPTION, SIZE, GRADE, BRAND) PG 64 - 28		* USE OF MATERIAL Base & Leveling 1/2" HMAC	
* SOURCE OF MATERIAL (MANUFACTURER, SUPPLIER, OR SOURCE NO. & NAME FOR NATURAL MATERIALS) Albina		SAMPLED AT (LOCATION OR STATION NUMBERS) Truck at Plant	
NUMBER OF SAMPLES (BAGS, BOXES, OTHER) 12 cans	QUANTITY REPRESENTED BY SAMPLE 1 per 1000 ton HMAC subplot	DATE SAMPLED 10/18/2012	
* CLASS OF SAMPLE			DATE SHIPPED 10/19/2012
<input checked="" type="checkbox"/> QUALITY CONTROL		<input type="checkbox"/> VERIFICATION	
<input type="checkbox"/> SOURCE/PRODUCT COMPLIANCE		<input type="checkbox"/> OTHER (SPECIFY IN REMARKS)	
<input type="checkbox"/> THIRD PARTY		BID ITEM NUMBER 580	SAMPLE NUMBER see below
* FIELD TESTED OR SUBMITTED BY (PRINT NAME) Scott Aker		SIGNATURE	
COMPANY NAME Eek Testers LLC			
STREET ADDRESS 123 Hwy St		CREW NUMBER 1234	
CITY, STATE AND ZIP CODE Roseburg, OR 97470		* PHONE NUMBER (123)123-1234	
* PROJECT MANAGER CONTACT John Consultant #98764		* CONTACT PHONE NUMBER (321) 321-4321	

* ACP MIX DESIGN no.		REMARKS / SPECIAL REQUIREMENTS
ODOT LAB/JMF#	CONTRACTOR MIX #	
10-MD0001	AS30RL4.1	<p>"The EA (or Con Number), Data sheet number, grade of the material (i.e. "PG 64-22"), name of the oil manufacturer, class of sample, lot and subplot, date, submitted by name and contact number, and project contact person name and contact number is required for the sample to be accepted. Only one type of sample may be submitted per Sample Data Sheet."</p> <p>Please make sure to label the SAMPLE containers with; Product ID (CSS 1 Tack or 19 mm Base Agg), Test number (Lot & Sublot), Date, and Data Sheet Number.</p> <p>In a manner that will with stand the elements (water, wind, and wild shipping companies).</p>
ASPHALT CEMENT		
** Lot & Sublot	** Date	
1-1	10/16/2012	
1-2	10/16/2012	
1-3	10/17/2012	
1-4	10/17/2012	
1-5	10/18/2012	
2-1	10/18/2012	

Note: * Required information. If information is missing, testing will be delayed.
 ** Additional information required for Asphalt Cement samples.
 734-4000 (10-2015)

SAMPLE DATA SHEET

LABORATORY REPORT NUMBER

* CON NO. & EA CON01111	* DATA SHEET NUMBER F - 43048 - 001	
PROJECT NAME (SECTION) Form Example		CONTRACT NUMBER
CONTRACTOR OR SUPPLIER ODOT Forms	PROJECT MANAGER Sean Parker	CREW NUMBER 1234

COMPLETE THIS SECTION FOR ALL SAMPLES One Data Sheet Per Asphalt Cement Type or Aggregate Size

* MATERIAL (DESCRIPTION, SIZE, GRADE, BRAND) 3/4"-0	* USE OF MATERIAL Base Aggregate	
* SOURCE OF MATERIAL (MANUFACTURER, SUPPLIER, OR SOURCE NO. & NAME FOR NATURAL MATERIALS) Newton Creek Quarry 10-216-3	SAMPLED AT (LOCATION OR STATION NUMBERS) Final Belt	
NUMBER OF SAMPLES (BAGS, BOXES, OTHER) 2 Bags	QUANTITY REPRESENTED BY SAMPLE Annual Compliance	DATE SAMPLED 10/18/2012
* CLASS OF SAMPLE		DATE SHIPPED 10/19/2012
<input type="checkbox"/> QUALITY CONTROL <input type="checkbox"/> VERIFICATION <input type="checkbox"/> THIRD PARTY		BID ITEM NUMBER 550
<input checked="" type="checkbox"/> SOURCE/PRODUCT COMPLIANCE <input type="checkbox"/> OTHER (SPECIFY IN REMARKS)		
* FIELD TESTED OR SUBMITTED BY (PRINT NAME) Scott Aker		SIGNATURE
COMPANY NAME Eek Testers LLC		
STREET ADDRESS 123 Hwy St		CREW NUMBER 1234
CITY, STATE AND ZIP CODE Roseburg, OR 97470		* PHONE NUMBER (123)123-1234
* PROJECT CONTACT PERSON John Consultant #98764		* CONTACT PHONE NUMBER (321) 321-4321

* ACP MIX DESIGN no.	REMARKS / SPECIAL REQUIREMENTS	
ODOT LAB/JMF#	CONTRACTOR MIX #	
ASPHALT CEMENT	<p>"The EA (or Con Number), Data sheet number, size of material (i.e. 3/4" - 1/4"), source number, use of material (i.e. "Base Rock"), class of sample, submitted by name and contact number, and project contact person name and contact number is required for the sample to be accepted. Only one type of sample may be submitted per Sample Data Sheet."</p>	
** Lot & Sublot		** Date

Note: * Required information. If information is missing, testing will be delayed.
 ** Additional information required for Asphalt Cement samples.
 734-4000 (10-2015)

SAMPLE DATA SHEET

LABORATORY REPORT NUMBER

* CON NO. & EA CON01111	* DATA SHEET NUMBER F - 43048 - 001	
PROJECT NAME (SECTION) Form Example		CONTRACT NUMBER 12345
CONTRACTOR OR SUPPLIER ODOT Forms	PROJECT MANAGER Sean Parker	CREW NUMBER 1234

COMPLETE THIS SECTION FOR ALL SAMPLES One Data Sheet Per Asphalt Cement Type or Aggregate Size

* MATERIAL (DESCRIPTION, SIZE, GRADE, BRAND) L3 1/2" Dense HMAc	* USE OF MATERIAL Base and Leveling	
* SOURCE OF MATERIAL (MANUFACTURER, SUPPLIER, OR SOURCE NO. & NAME FOR NATURAL MATERIALS) Industry Standard LLC	SAMPLED AT (LOCATION OR STATION NUMBERS) Plant Discharge	
NUMBER OF SAMPLES (BAGS, BOXES, OTHER) 2 10,000g Boxes	QUANTITY REPRESENTED BY SAMPLE	DATE SAMPLED 10/18/2012
* CLASS OF SAMPLE		DATE SHIPPED 10/19/2012
<input type="checkbox"/> QUALITY CONTROL <input type="checkbox"/> VERIFICATION <input type="checkbox"/> THIRD PARTY		BID ITEM NUMBER 570
<input type="checkbox"/> SOURCE/PRODUCT COMPLIANCE <input checked="" type="checkbox"/> OTHER (SPECIFY IN REMARKS)		
* FIELD TESTED OR SUBMITTED BY (PRINT NAME) Scott Aker		SIGNATURE
COMPANY NAME Eek Testers LLC		CREW NUMBER 1234
STREET ADDRESS 123 Hwy St		* PHONE NUMBER (123)123-1234
CITY, STATE AND ZIP CODE Roseburg, OR 97470		* CONTACT PHONE NUMBER (321) 321-4321
* PROJECT CONTACT PERSON John Consultant #98764		

* ACP MIX DESIGN no.	ODOT LAB/JMF#	CONTRACTOR MIX #	REMARKS / SPECIAL REQUIREMENTS
	10-MD0001	AS30RL3.1	"The EA (or Con Number), Data sheet number, material (i.e. "level 3 HMAc"), use of material (i.e. "Base lift"), class of sample, Mix Design Info., submitted by name and contact number, and project contact person name and contact number is required for the sample to be accepted. Only one type of sample may be submitted per Sample Data Sheet." (Example) 2 boxes of mix for testing per AASHTO T308, AASHTO T30 and AASHTO T209.
ASPHALT CEMENT			
** Lot & Sublot	** Date		

Note: * Required information. If information is missing, testing will be delayed.
 ** Additional information required for Asphalt Cement samples.
 734-4000 (10-2015)

SAMPLE DATA SHEET FOR CONCRETE CYLINDERS

E

English (E) or Metric (M)

* CON NO. & EA				* DATA SHEET NUMBER F - -				LABORATORY REPORT NUMBER				
PROJECT NAME (SECTION)								CONTRACT NUMBER				
CONTRACTOR				PROJECT MANAGER				BID ITEM NUMBER				
CONCRETE SUPPLIER				* SUBMITTED BY				QUANTITY REPRESENTED yd ³				
CONCRETE FOR USE IN (LOCATION OR PLACEMENT)						BRIDGE NUMBER		* SPECIFIED STRENGTH PSI DAYS				
REPRESENTED BY NO. OF CYLS.		SET NUMBER		* DATE CAST		DATE SHIPPED		CYLINDER SIZE		INVOICE NUMBER		
* TEST SPECIMENS AT DAYS INDICATED										YIELD yd ³		
A.	B.	C.	D.	E.	F.	G.	H.					
* MIX DESIGN	* ODOT LAB / MIX DESIGN NUMBER		* CONCRETE SUPPLIER MIX DESIGN NUMBER		* DESIGN CEMENTITIOUS MATERIAL CONTENT lb/yd ³		* FREE (SURFACE) MOISTURE		* COARSE #1 %	* COARSE #2 %	* COARSE #3 %	* SAND %
* AMBIENT TEMP. °F	* CONCRETE TEMP. °F	* SLUMP in	* AIR CONTENT %	* UNIT WEIGHT lb/ft ³		* CEMENTITIOUS MAT. CONTENT lb/yd ³		* FIELD W/C RATIO BY WT.				
* ADDITIVES oz		* CEMENT lb	* FLYASH lb	* SILICA lb		* WATER BATCHED lb		* NET WEIGHT		* POT CALIBRATION		
* AGGREGATE #1 lb	* AGGREGATE #2 lb	* AGGREGATE #3 lb	* FINE AGG (SAND) lb		* WATER AT JOB lb		* CURING		* CAPPING			
* PROJECT CONTACT PERSON				* CONTACT PHONE NUMBER				* TIME CYL CAST	* LOW TEMP. °F	* HIGH TEMP. °F		
FIELD REMARKS												
<input type="checkbox"/> QUALITY CONTROL	<input type="checkbox"/> VERIFICATION	<input type="checkbox"/> INFO	* PHONE No.				FAX No.					
T 23 CERTIFIED TECHNICIAN (PLEASE PRINT) AND CARD NUMBER				COMPANY NAME				SIGNATURE		DATE		

LAB USE ONLY BELOW

CYLINDER ID	DATE OF BREAK	AGE DAYS	MAXIMUM LOAD	CYLINDER AREA	STRENGTH PSI	COMPOUND TYPE / PAD DUROMETER	BREAK TYPE	REMARKS
A								
B								
C								
D								
E								
F								
G								
H								

AVE _____ DAY PSI PASS FAIL

COMMENTS (WHEN MATERIAL ,CYLINDERS OR DATA RECEIVED)

<input type="checkbox"/> QUALITY CONTROL	<input type="checkbox"/> VERIFICATION	CYLINDERS REC'D		DATA SHEET RECD	
T 22 CERTIFIED TECHNICIAN (PLEASE PRINT) AND CARD NUMBER		COMPANY NAME		SIGNATURE	DATE

Note: * Required information. If this information is missing, testing will be delayed.

SAMPLE DATA SHEET FOR CONCRETE CYLINDERS

E

English (E) or Metric (M)

* CON NO. & EA CON01234		* DATA SHEET NUMBER F - 43048 - 001		LABORATORY REPORT NUMBER	
PROJECT NAME (SECTION) Forms Example					CONTRACT NUMBER 12345
CONTRACTOR ODOT Forms			PROJECT MANAGER Sean Parker		BID ITEM NUMBER 123
CONCRETE SUPPLIER The Best Ready Mix			* SUBMITTED BY Scott Aker		QUANTITY REPRESENTED 150 yd³
CONCRETE FOR USE IN (LOCATION OR PLACEMENT) Deck			BRIDGE NUMBER 1234a	* SPECIFIED STRENGTH 5000 PSI 28 DAYS	
REPRESENTED BY NO. OF CYLS. 5	SET NUMBER 1	* DATE CAST 10/10/12	DATE SHIPPED 10/11/12	CYLINDER SIZE 4" x 8"	INVOICE NUMBER 123456
* TEST SPECIMENS AT DAYS INDICATED					YIELD 9.23 yd³
A. 7	B. 14	C. 28	D. 28	E. 28	F.
G. 	H. 				
* MIX DESIGN 08-0001	* ODOT LAB / MIX DESIGN NUMBER 08-0001	* CONCRETE SUPPLIER MIX DESIGN NUMBER BRMHPC5000FM	* DESIGN CEMENTITIOUS MATERIAL CONTENT 780 lb/yd³	* FREE (SURFACE) MOISTURE	
		* COARSE #1 0.30 %	* COARSE #2 %	* COARSE #3 %	* SAND 7.90 %
* AMBIENT TEMP. 40.5 °F	* CONCRETE TEMP. 60.5 °F	* SLUMP 6 1/2" in	* AIR CONTENT 4.9 %	* UNIT WEIGHT 144.9 lb/ft³	* CEMENTITIOUS MAT. CONTENT 779 lb/yd³
				* FIELD W/C RATIO 0.29 BY WT.	
* ADDITIVES 1156 oz	* CEMENT 4735 lb	* FLYASH 2165 lb	* SILICA 288 lb	* WATER BATCHED 1186 lb	* NET WEIGHT 36.22
				* POT CALIBRATION 0.249900	
* AGGREGATE #1 17600 lb	* AGGREGATE #2 0 lb	* AGGREGATE #3 0 lb	* FINE AGG (SAND) 10080 lb	* WATER AT JOB 0 lb	* CURING Tank
				* CAPPING Pad	
* PROJECT CONTACT PERSON John Consultant			* CONTACT PHONE NUMBER 123-123-1234		* TIME CYL CAST 7:30am
				* LOW TEMP. 65 °F	* HIGH TEMP. 75 °F

FIELD REMARKS

"The EA (or Con Number), Data sheet number, specified strength, date cast, the number of days to test the specimens, and the field test results including the curing and capping methods, submitted by name and contact number, and project contact person name and contact number is required for the sample to be accepted. Only one type of sample may be submitted per Sample Data Sheet."

<input checked="" type="checkbox"/> QUALITY CONTROL	<input type="checkbox"/> VERIFICATION	<input type="checkbox"/> INFO	* PHONE No. 123-123-1234	FAX No. 123-123-9876
T 23 CERTIFIED TECHNICIAN (PLEASE PRINT) AND CARD NUMBER Scott Aker #43048		COMPANY NAME ODOT	SIGNATURE	DATE 10/10/12

LAB USE ONLY BELOW

CYLINDER ID	DATE OF BREAK	AGE DAYS	MAXIMUM LOAD	CYLINDER AREA	STRENGTH PSI	COMPOUND TYPE / PAD DUROMETER	BREAK TYPE	REMARKS
A	10/17/12	7	52500	12.56	4180	60	Shear	
B	10/24/12	14	59500	12.56	4740	60	Shear	
C	11/07/12	28	69540	12.56	5540	60	Cone	
D	11/07/12	28	70330	12.56	5600	60	Shear	
E	11/07/12	28	71850	12.56	5720	60	Shear	
F								
G								
H								

AVE 28 DAY 5620 PSI PASS FAIL

COMMENTS (WHEN MATERIAL ,CYLINDERS OR DATA RECEIVED)

<input checked="" type="checkbox"/> QUALITY CONTROL	<input type="checkbox"/> VERIFICATION	CYLINDERS REC'D 10/11/2012	DATA SHEET REC'D 10/11/2012
T 22 CERTIFIED TECHNICIAN (PLEASE PRINT) AND CARD NUMBER Scott Aker #43048		COMPANY NAME ODOT	SIGNATURE
			DATE 11/7/2012

Note: * Required information. If this information is missing, testing will be delayed.

QC/QA TESTING INVESTIGATION

PROJECT NAME (SECTION)		CONTRACT NUMBER
CONTRACTOR OR SUPPLIER	PROJECT MANAGER	BID ITEM NUMBER
MATERIAL DESCRIPTION		SOURCE NAME & NUMBER IF APPLICABLE
QA TEST NUMBER ID.	QC TEST NUMBER ID.	TEST PROCEDURE OR PROCESS UNDER INVESTIGATION

<input type="checkbox"/>	FAILED I.A. PARAMETERS	<input type="checkbox"/>	QA FAILED VERIFICATION
<input type="checkbox"/>	QC FAILED VERIFICATION	<input type="checkbox"/>	QUESTIONABLE QC HISTORY

INVESTIGATION DESCRIPTION:	CONTINUED ON ADDITIONAL SHEETS

INVESTIGATION SUMMARY:	CONTINUED ON ADDITIONAL SHEETS

CONCLUSION / RESOLUTION:	CONTINUED ON ADDITIONAL SHEETS

COMMENTS OR FOLLOW-UPS:	CONTINUED ON ADDITIONAL SHEETS

INDIVIDUAL PERFORMING INVESTIGATION (PLEASE PRINT)	COMPANY NAME	SIGNATURE	DATE
PROJECT MANAGER or CPM REVIEW/APPROVAL (PLEASE PRINT)	COMPANY NAME	SIGNATURE	DATE

Distribution: QAC, QC, PM, CPM, QAE and Project File

QC/QA TESTING INVESTIGATION

PROJECT NAME (SECTION) <p style="text-align: center;">A Bridge Too Far</p>		CONTRACT NUMBER <p style="text-align: center;">C12889</p>
CONTRACTOR OR SUPPLIER <p style="text-align: center;">Black and Sticky</p>	PROJECT MANAGER <p style="text-align: center;">John Behold</p>	BID ITEM NUMBER <p style="text-align: center;">745</p>
MATERIAL DESCRIPTION <p style="text-align: center;">Level 3, 1/2" Dense Graded HMAC</p>		SOURCE NAME & NUMBER IF APPLICABLE <p style="text-align: center;">Hard Rock, Source # 2-889-65</p>
QA TEST NUMBER ID. <p style="text-align: center;">QA-V1</p>	QC TEST NUMBER ID. <p style="text-align: center;">QC-V1</p>	TEST PROCEDURE OR PROCESS UNDER INVESTIGATION <p style="text-align: center;">HMAC Density Testing</p>

<input type="checkbox"/>	FAILED I.A. PARAMETERS	<input checked="" type="checkbox"/>	QA FAILED VERIFICATION
<input type="checkbox"/>	QC FAILED VERIFICATION	<input type="checkbox"/>	QUESTIONABLE QC HISTORY

INVESTIGATION DESCRIPTION:	CONTINUED ON ADDITIONAL SHEETS
----------------------------	--------------------------------

On October 15, 2006 Region QA performed verification testing (QA-V1) on a Level3, 1/2" Dense Graded HMAC. The contractor had placed 3005.26 tons of material on this date and had performed density testing for 3 sublots of HMAC. QA testing represented 1000 tons of HMAC and spanned testing performed by QC through sublots 1 & 2. The QC results showed all density measurements meeting and exceeding the contract criteria for a base lift application of (91.0%). QC testing showing an overall average for all 3 sublots to be (91.9%). The QA testing showed failing density in their represented area with an average compaction of 89.2%. QA had shot several of the QC existing locations and still had approximately a 2% difference. QA did indicate the QC technician was performing the testing according to the test procedure.

INVESTIGATION SUMMARY:	<input checked="" type="checkbox"/> CONTINUED ON ADDITIONAL SHEETS
------------------------	--

*The Region QAC suggested both gauges be evaluated over the blocks according to TM 304 test procedure to ensure calibration integrity still existed. After completion of the calibration check, the Region gauge met test procedure criteria but the QC gauge failed the high block evaluation and the gauge was reading on the high side giving a false indication of achieving density. Several options were discussed with the PM and it was decided that the subplot's in question would be evaluated through a core analysis. Both parties agreed that 5 cores would be randomly removed from each of the three sublots and the results would replace the current gauge readings for statistical evaluation. It was also decided a core correlation would be performed on 10 of the core locations for future density testing. Prior to the core removals the QC gauge was re-calibrated and verified according to TM 304. **See Next page for further details.***

CONCLUSION / RESOLUTION:	CONTINUED ON ADDITIONAL SHEETS
--------------------------	--------------------------------

In conclusion, results of the core analysis did show the subplot's in question were failing density requirements. The core results showed an overall average density of 90.4%, which is 0.6% below the 91.0% compaction criteria. The failing results were discussed with the PQE and the sublots in question were placed into a different lot and the statistical analysis (CPF) showed 0.6789. The PM decided to allow the material to remain in place and applied the appropriate price reduction according to section 00165 & 00150.25. The PM and PQE determined the in-place material was suitable for the intended use and 3 subsequent lifts of material were going to be placed over the failing area, so the associated risk of leaving the material in place was minimal. See CCO #5 for allowance of in-place density according to the core method.

COMMENTS OR FOLLOW-UPS:	CONTINUED ON ADDITIONAL SHEETS
-------------------------	--------------------------------

A request to the Region QA for additional testing will be made to ensure the QC gauge is holding calibration and specified density is being achieved.

INDIVIDUAL PERFORMING INVESTIGATION (PLEASE PRINT)	COMPANY NAME	SIGNATURE	DATE
Sean P. Parker	ODOT		
PROJECT MANAGER or CPM REVIEW/APPROVAL (PLEASE PRINT)	COMPANY NAME	SIGNATURE	DATE
John Behold	ODOT		

Distribution: QAC, QC, PM, CPM, QAE and Project File

QC/QA TESTING INVESTIGATION

PROJECT NAME (SECTION) <p style="text-align: center;">A Bridge Too Far</p>		CONTRACT NUMBER <p style="text-align: center;">C12889</p>
CONTRACTOR OR SUPPLIER <p style="text-align: center;">Black and Sticky</p>		PROJECT MANAGER <p style="text-align: center;">John Behold</p>
MATERIAL DESCRIPTION <p style="text-align: center;">Level 3, 1/2" Dense Graded HMAC</p>		BID ITEM NUMBER <p style="text-align: center;">745</p>
SOURCE NAME & NUMBER IF APPLICABLE <p style="text-align: center;">Hard Rock, Source # 2-889-65</p>		
QA TEST NUMBER ID. <p style="text-align: center;">QA-V1</p>	QC TEST NUMBER ID. <p style="text-align: center;">QC-V1</p>	TEST PROCEDURE OR PROCESS UNDER INVESTIGATION <p style="text-align: center;">HMAC Density Testing</p>

<input type="checkbox"/>	FAILED I.A. PARAMETERS	<input checked="" type="checkbox"/>	QA FAILED VERIFICATION
<input type="checkbox"/>	QC FAILED VERIFICATION	<input type="checkbox"/>	QUESTIONABLE QC HISTORY

INVESTIGATION DESCRIPTION:	CONTINUED ON ADDITIONAL SHEETS

INVESTIGATION SUMMARY:	CONTINUED ON ADDITIONAL SHEETS
<p><i>During the re-calibration phase the QA technician discovered the handle was loose and not maintaining a locked position in the backscatter mode. In addition, the block area of the gauge was extremely dirty and difficult to engage and disengage. These problems were corrected and the gauge was placed back in service.</i></p>	

CONCLUSION / RESOLUTION:	CONTINUED ON ADDITIONAL SHEETS

COMMENTS OR FOLLOW-UPS:	CONTINUED ON ADDITIONAL SHEETS

INDIVIDUAL PERFORMING INVESTIGATION (PLEASE PRINT)	COMPANY NAME	SIGNATURE	DATE
Sean P. Parker	ODOT		
PROJECT MANAGER or CPM REVIEW/APPROVAL (PLEASE PRINT)	COMPANY NAME	SIGNATURE	DATE
John Behold	ODOT		

Distribution: QAC, QC, PM, CPM, QAE and Project File

QC/QA TESTING INVESTIGATION

PROJECT NAME (SECTION) A Bridge Too Far		CONTRACT NUMBER C12889
CONTRACTOR OR SUPPLIER Black and Sticky		PROJECT MANAGER John Behold
MATERIAL DESCRIPTION 1/2" - #4 Aggregate for L3 Dense HMAC		BID ITEM NUMBER 745
QA TEST NUMBER ID. QA-V1	QC TEST NUMBER ID. QC-V1	SOURCE NAME & NUMBER IF APPLICABLE Hard Rock, Source # 2-889-65
TEST PROCEDURE OR PROCESS UNDER INVESTIGATION HMAC Density Testing		
X FAILED I.A. PARAMETERS <input type="checkbox"/> QA FAILED VERIFICATION		
<input type="checkbox"/> QC FAILED VERIFICATION <input type="checkbox"/> QUESTIONABLE QC HISTORY		
INVESTIGATION DESCRIPTION:		CONTINUED ON ADDITIONAL SHEETS
<p><i>On October 15, 2006 Region QA performed verification testing (QA-V1) on Level 3 1/2" - #4 HMAC aggregate. The split sample results were within specification for both QC and QA, however, the results were not within I.A. parameters for the #4 sieve. The QC test showed the #4 at 9% passing and the QA test showed the #4 at 15%, a difference of 6%. The I.A. parameter allows 5% maximum difference.</i></p>		
INVESTIGATION SUMMARY:		CONTINUED ON ADDITIONAL SHEETS
<p><i>Because the results were within specification the investigation was initially restricted to the (QA-V1) original sample. The tested samples were swapped between the QA and QC technicians and passed through the sieves. The original results were verified by the opposite technician. QC got 15% passing on the QA side of the split and QA got 9% passing on the QC side of the split.</i></p>		
CONCLUSION / RESOLUTION:		CONTINUED ON ADDITIONAL SHEETS
<p><i>The results of the investigation indicate that the difference in the results was due to a bad split on the verification. The ongoing QC results show the average passing the #4 sieve at 12%.</i></p> <p><i>As a result of this investigation the ongoing QC results are acceptable.</i></p>		
COMMENTS OR FOLLOW-UPS:		CONTINUED ON ADDITIONAL SHEETS
<p><i>The project QCCS will be observing the QC technician performing the splitting and testing procedures to ensure that splitting is being done properly ASAP.</i></p>		
INDIVIDUAL PERFORMING INVESTIGATION (PLEASE PRINT)		
Sean P. Parker	COMPANY NAME	SIGNATURE DATE
PROJECT MANAGER or CPM REVIEW/APPROVAL (PLEASE PRINT)		
John Behold	COMPANY NAME	SIGNATURE DATE

Distribution: QAC, QC, PM, CPM, QAE and Project File



PAVEMENT MARKING RETROREFLECTIVITY TESTING
FORM 734-4101 | GENERAL INFORMATION

PROJECT NAME (SECTION)			HIGHWAY
CONTRACTOR		CONTRACT NUMBER	
PROJECT BEGIN MP/STATION	PROJECT END MP/STATION	PROJECT (LOT) LENGTH (Miles)	NUMBER OF SUBLOTS

NO. OF FORM 734-4102 ATTACHED	NO. OF FORM 734-4103 ATTACHED	NO. OF FORM 734-4104 ATTACHED	NO. OF FORM 734-4105 ATTACHED
-------------------------------	-------------------------------	-------------------------------	-------------------------------

PROJECT ACCEPTANCE RESULTS				
	LONGITUDINAL MARKINGS		TRANSVERSE MARKINGS	
	WHITE	YELLOW	WHITE	YELLOW
SUBLOT 1				
SUBLOT 2				
SUBLOT 3				
SUBLOT 4				
SUBLOT 5				
SUBLOT 6				
SUBLOT 7				
SUBLOT 8				
SUBLOT 9				
SUBLOT 10				
SUBLOT 11				
SUBLOT 12				
SUBLOT 13				
SUBLOT 14				
SUBLOT 15				
SUBLOT 16				
SUBLOT 17				
SUBLOT 18				
SUBLOT 19				
SUBLOT 20				

NAME OF TECHNICIAN (PLEASE PRINT)	COMPANY NAME	SIGNATURE	DATE
-----------------------------------	--------------	-----------	------



PAVEMENT MARKING RETROREFLECTIVITY TESTING
FORM 734-4101 | GENERAL INFORMATION

PROJECT NAME (SECTION) US97: Terrebonne - Redmond			HIGHWAY 014 CROOKED RIVER
CONTRACTOR Pavement Markings 'R' Us		CONTRACT NUMBER C7149	
PROJECT BEGIN MP/STATION 112.68	PROJECT END MP/STATION 124.32	PROJECT (LOT) LENGTH (Miles) 1.119	NUMBER OF SUBLOTS 1

NO. OF FORM 734-4102 ATTACHED	NO. OF FORM 734-4103 ATTACHED	NO. OF FORM 734-4104 ATTACHED	NO. OF FORM 734-4105 ATTACHED

PROJECT ACCEPTANCE RESULTS				
	LONGITUDINAL MARKINGS		TRANSVERSE MARKINGS	
	WHITE	YELLOW	WHITE	YELLOW
SUBLOT 1	PASS	PASS W/ ADDITIONAL TESTING	PASS	
SUBLOT 2				
SUBLOT 3				
SUBLOT 4				
SUBLOT 5				
SUBLOT 6				
SUBLOT 7				
SUBLOT 8				
SUBLOT 9				
SUBLOT 10				
SUBLOT 11				
SUBLOT 12				
SUBLOT 13				
SUBLOT 14				
SUBLOT 15				
SUBLOT 16				
SUBLOT 17				
SUBLOT 18				
SUBLOT 19				
SUBLOT 20				

NAME OF TECHNICIAN (PLEASE PRINT) Cindy R. Wade	COMPANY NAME Mainline Utility Testing Tech	SIGNATURE	DATE
---	--	------------------	-------------



PAVEMENT MARKING RETROREFLECTIVITY TESTING
FORM 734-4102 | LONGITUDINAL MARKINGS

PROJECT NAME (SECTION) US97: Terrebonne - Redmond		HIGHWAY 014 CROOKED RIVER	CONTRACT NUMBER C7149
CONTRACTOR Pavement Markings 'R' Us			BID ITEM NUMBER 0865-0114000
SUBLOT NUMBER 1	SUBLOT BEGINNING STATION/LOCATION DESCRIPTION 1645+80	SUBLOT ENDING STATION/LOCATION DESCRIPTION 1704+88	

METHOD OF LONGITUDINAL MARKING Method E	MATERIAL Thermoplastic		BEAD TYPE 3130
MATERIAL MANUFACTURER Ennis-Flint	PRODUCT CODE (WHITE) 885300	PRODUCT CODE (YELLOW) 884411	DATE OF MATERIAL APPLICATION 12/17/2014

RETROREFLECTOMETER EQUIPMENT USED Microlux Ultra Retroreflectometer	SERIAL NUMBER 1458932485	DATE OF LAST FACTORY CALIBRATION 04/27/2014
--	-----------------------------	--

DATE OF MEASUREMENTS 12/17/2014	ZERO & CALIBRATION READINGS (Attach Field Print-out) 3,9,0,4	WEATHER CONDITIONS	START TIME	END TIME
REMARKS: New Asphalt Surface		AMBIENT TEMP. (°F) 52°F	67°F	
		RELATIVE HUMIDITY 87%	51%	

LINE TYPE	DIRECTION	AVERAGE THICKNESS (mils)	AVERAGE GROOVE DEPTH (mils)	RETROREFLECTIVITY (mcd/m ² /lx) (Attach Field Print-out)										AVERAGE	% VALUES ABOVE MIN.	
				WHITE LONGITUDINAL MARKINGS												
W	Eastbound	120	N/A	500	537	486	433	444	489	460	433	510	506	423	96	
				476	481	528	488	430	464	405	500	498	487			
W	Westbound	123	N/A	309	302	314	318	302	303	307	317	304	335			
				314	284	309	295	270	278	248	330	278	243			
WB	Eastbound	120	125	459	514	512	509	617	616	634	612	476	511			
				512	527											

YELLOW LONGITUDINAL MARKINGS															
ND	Eastbound	121	N/A	253	301									292	89
ND	Westbound	120	N/A	264	247										
Y	Eastbound	120	N/A	194	253	294	279	189	282	281	292	299	183		
				330	312	309	302	314	318	293					
Y	Westbound	120	N/A	323	351	347	332	363	371	334	307	306	300		
				195	302	284	309	319	295	263					

SUBLOT ACCEPTANCE		
WHITE MARKINGS	YELLOW MARKINGS	ATTACH FIELD PRINTOUTS
<input checked="" type="checkbox"/> PASS	<input type="checkbox"/> PASS	<input checked="" type="checkbox"/> ZERO & CALIBRATION READINGS
<input type="checkbox"/> FAIL	<input type="checkbox"/> FAIL	<input checked="" type="checkbox"/> RETROREFLECTIVITY
<input type="checkbox"/> ADDITIONAL TESTING REQUIRED (Use ODOT Form 734-4104)	<input checked="" type="checkbox"/> ADDITIONAL TESTING REQUIRED (Use ODOT Form 734-4104)	

NAME OF TECHNICIAN (PLEASE PRINT) Cindy R. Wade	COMPANY NAME Mainline Utility Testing Tech	SIGNATURE	DATE
--	---	-----------	------

CAT II - MDV STARTUP REVIEW

PROJECT NAME (SECTION)				CONTRACT NUMBER	
CONTRACTOR OR SUPPLIER			PROJECT MANAGER		BID ITEM NUMBER
DATE	MIX DESIGN	BEGINNING LOT/SUBLOT	MATERIAL DESCRIPTION	TO BE USED IN	

MDV STARTUP REVIEW

CONDUCT REVIEW ACCORDING TO SECTION 00745.16(b)(1)(d) 1-4 MDV REQUIREMENTS AT STARTUP. If corrective action is required detail action taken and expected results below. If target adjustments are made, attach form 734-2560 (10-2017). Obtain Engineers approval prior to restarting if Va results exceed requirement of step 3 in Section 00745.16 (b)(1)(d)

MDV TEST DATA

DATE _____
TIME _____

TEST No. _____
TONAGE _____

SECTION 00745.16 (b)(1)(d)

1 2 3 4

check appropriate boxes to identify which steps this review represents in the MDV Startup Process

Va REQUIREMENT MET: YES NO

VMA REQUIREMENT MET: YES NO

CORRECTIVE ACTION REQUIRED: YES NO

RESULTS

TARGET ACTUAL

	TARGET	ACTUAL
VMA		
Va		
VFA		
Pb		
P #8		
P #30		
P #200		

ACTION TAKEN: _____

EXPECTED RESULT: _____

CERTIFIED TECHNICIAN CAT II (PLEASE PRINT) AND CARD NUMBER	COMPANY NAME	SIGNATURE	DATE
--	--------------	-----------	------

ENGINEERS APPROVAL REQUIRED PRIOR TO RESTARTING IF PRODUCTION STOPPED PER SECTION 00745.16 (b)(1)(d)

CAT II - MDV STARTUP REVIEW

PROJECT NAME (SECTION) <p style="text-align: center;">Forms Example</p>				CONTRACT NUMBER <p style="text-align: center;">12345</p>	
CONTRACTOR OR SUPPLIER <p style="text-align: center;">The HMAC Company</p>			PROJECT MANAGER <p style="text-align: center;">Sean Parker</p>		BID ITEM NUMBER <p style="text-align: center;">123</p>
DATE <p style="text-align: center;">10/10/2017</p>	MIX DESIGN <p style="text-align: center;">17-MD0000</p>	BEGINNING LOT/SUBLOT <p style="text-align: center;">1-1</p>	MATERIAL DESCRIPTION <p style="text-align: center;">L3 1/2" Dense HMAC</p>	TO BE USED IN <p style="text-align: center;">Base / Wearing</p>	

MDV STARTUP REVIEW

CONDUCT REVIEW ACCORDING TO SECTION 00745.16(b)(1)(d) 1-4 MDV REQUIREMENTS AT STARTUP. If corrective action is required detail action taken and expected results below. If target adjustments are made, attach form 734-2560 (10-2017). Obtain Engineers approval prior to restarting if Va results exceed requirement of step 3 in Section 00745.16 (b)(1)(d)

MDV TEST DATA

DATE 10/10/2017
TIME 8:00am

TEST No. 1-1
TONAGE 65

SECTION 00745.16(b)(1)(d)

1 2 3 4

check appropriate boxes to identify which steps this review represents in the MDV Startup Process

Va REQUIREMENT MET: YES NO

VMA REQUIREMENT MET: YES NO

CORRECTIVE ACTION REQUIRED: YES NO

RESULTS

	TARGET	ACTUAL
VMA	15.4	15.0
Va	4.0	2.7
VFA	74	82
Pb	5.70	5.69
P #8	38	37
P #30	14	13
P #200	5.0	5.1

ACTION TAKEN: Lab results indicate mix was produced close to JMF targets, However Voids and VFA are out of tolerance. Density results from the grade were reported to be 95.1% which reconcile with the Voids results from the lab. Pb results from the lab test were .01% lower than target. Propose Pb change reducing the target from 5.70% to 5.30%.

EXPECTED RESULT: Reducing Pb by 0.40% to 5.30% should bring Voids to approximately 3.9% without adversely affecting VMA. If the expected result from this change brings the Voids to 3.9% VFA should drop back to the JMF target of 74. All other constituents staying the same the mix should be within tolerance and field densities should fall within reasonable values of 92.2 to 94.1%. After adjustments are made another sample will immediately be taken and results reviewed in accordance with step 3 and 4 of the MDV Start-Up Process.

CERTIFIED TECHNICIAN CAT II (PLEASE PRINT) AND CARD NUMBER <p style="text-align: center;">Scott Aker #43048</p>	COMPANY NAME <p style="text-align: center;">ODOT</p>	SIGNATURE	DATE <p style="text-align: center;">10/10/2017</p>
--	---	-----------	---

ENGINEERS APPROVAL REQUIRED PRIOR TO RESTARTING IF PRODUCTION STOPPED PER SECTION 00745.16(b)(1)(d)

CAT II - DENSITY / CONTROL STRIP RECONCILIATION

E

English (E) or Metric (M)

PROJECT NAME (SECTION)				CONTRACT NUMBER	
CONTRACTOR OR SUPPLIER			PROJECT MANAGER		BID ITEM NUMBER
DATE	MIX DESIGN	BEGINNING SUBLOT	MATERIAL DESCRIPTION	TO BE USED IN	

QUALITY CONTROL LAB RESULTS

TEST NUMBER	DATE	TIME
VMA	VFA	Pb
P #8	P #30	P #200
P #200 / Pbe	Va	
PREDICTED DENSITY RANGE:		

CONTROL STRIP RESULTS

CONTROL STRIP NUMBER	DATE	TIME
LIFT NUMBER	PERCENT REQUIRED	INITIAL POINT % COMP

CONTROL STRIP - % COMPACTION

LEFT EDGE	MIDPOINT LEFT	CENTER	MIDPOINT RIGHT	RIGHT EDGE
CONTROL STRIP AVERAGE				

LABORATORY / CONTROL STRIP RECONCILE: YES NO

NOTE: IF CONTROL STRIP DOES NOT RECONCILE
DETAIL CORRECTIVE ACTION BELOW

CORRECTIVE ACTION TAKEN / RESOLUTION: (If new control strip performed a new reconciliation report is required)

CERTIFIED TECHNICIAN CAT II (PLEASE PRINT) AND CARD NUMBER	COMPANY NAME	SIGNATURE	DATE
--	--------------	-----------	------

CAT II - DENSITY / CONTROL STRIP RECONCILIATION

E

English (E) or Metric (M)

PROJECT NAME (SECTION) Form Example					CONTRACT NUMBER 12345
CONTRACTOR OR SUPPLIER The HMAC Company			PROJECT MANAGER Sean Parker		BID ITEM NUMBER 123
DATE 10/10/2012	MIX DESIGN 12-MD0000	BEGINNING SUBLLOT 1-1	MATERIAL DESCRIPTION L3 1/2" Dense HMAC	TO BE USED IN Base	

QUALITY CONTROL LAB RESULTS

TEST NUMBER 1-1	DATE 10/10/2012	TIME 8:00am
VMA 15.0	VFA 74	Pb 5.00
P #8 37	P #30 13	P #200 5.1
P #200 / Pbe 1.13	Va 3.9	
PREDICTED DENSITY RANGE: 92.2% - 94.1%		

CONTROL STRIP RESULTS

CONTROL STRIP NUMBER 1	DATE 10/10/2012	TIME 10:30am
LIFT NUMBER 1	PERCENT REQUIRED 92.0%	INITIAL POINT % COMP 95.8%

CONTROL STRIP - % COMPACTION

LEFT EDGE 95.5%	MIDPOINT LEFT 95.0%	CENTER 95.0%	MIDPOINT RIGHT 95.7%	RIGHT EDGE 95.9%
CONTROL STRIP AVERAGE 95.4%				

LABORATORY / CONTROL STRIP RECONCILE: YES NO

NOTE: IF CONTROL STRIP DOES NOT RECONCILE
 DETAIL CORRECTIVE ACTION BELOW

CORRECTIVE ACTION TAKEN / RESOLUTION: (If new control strip performed a new reconciliation report is required)

Lab results indicate the mix is being produced close to JMF targets and compaction in the field may be artificially high. Density technician checked gauge accuracy by running comparison tests with ODOT QA gauge and found the gauges were reading within one percent of each other. Core correlation was then performed and after applying the correction to the the control strip the resulting average of 93.6 effectively reconciling the lab results and the control strip.

CERTIFIED TECHNICIAN CAT II (PLEASE PRINT) AND CARD NUMBER Scott Aker #43048	COMPANY NAME ODOT	SIGNATURE	DATE 10/10/2012
--	-----------------------------	-----------	---------------------------

Random Number Table

Line/Col.	1	2	3	4	5	6	7	8	9	10	11
1	16897	16881	22931	30360	86899	51400	15815	41234	81861	82040	35678
2	16066	03723	89146	22426	63867	63506	17781	49403	04287	20424	07348
3	85075	44878	72033	58248	77069	18971	39182	30082	56504	46566	42681
4	92639	30948	57302	81544	63775	52944	80353	63289	86249	75673	09155
5	35721	37005	49818	86207	62735	44649	23672	06383	04114	28132	05908
6	40489	59044	89605	35282	26421	01022	61386	92737	87214	45817	91765
7	44342	01656	85330	48692	24303	00857	37624	26026	24111	11525	09849
8	48339	55094	00436	05613	45626	16491	78652	60998	80789	51080	74835
9	78149	23513	40239	08012	07515	30771	22169	42811	65528	69258	08210
10	53975	05987	19104	37420	24813	05085	57626	68003	81529	15681	28910
11	47292	70452	34590	31785	85351	54591	59692	55567	45079	45751	40201
12	34542	53478	24010	23177	47320	47810	63102	42071	01144	52342	74604
13	07353	34902	98261	40943	21138	20089	18299	39147	87712	40470	72981
14	70361	33031	17937	83411	03889	16309	94376	88326	69494	20471	67255
15	33361	61660	86771	02004	01567	06219	97827	75885	90188	56494	52163
16	12998	73394	24693	34225	42333	69609	53915	18304	82164	56042	12097
17	29623	44833	25355	29022	41902	42322	67751	04941	42039	86077	87066
18	94859	35317	68957	47114	24840	73777	87089	17554	15613	59887	68990
19	68417	40318	85951	46929	07799	11666	94557	69499	73074	78549	50198
20	11826	65897	95213	07860	14082	23312	72457	17117	27707	33332	76374
21	85532	33390	48065	62862	93745	87022	68944	18825	96608	12332	31279
22	09588	86051	27474	46612	94954	66084	28031	11486	26895	56861	49260
23	99396	93908	91658	93214	79134	00272	89581	92129	23926	01510	55723
24	78462	91590	31144	91250	85550	11080	97373	63397	39601	43019	09742
25	98696	01557	06498	39892	02702	52858	36984	45515	21716	92369	81682

RESIN BONDED ANCHOR PULL TEST

PROJECT NAME (SECTION)						CONTRACT NUMBER	
CONTRACTOR OR SUPPLIER			PROJECT MANAGER		BID ITEM NUMBER		TEST DATE
ANCHOR TYPE	ANCHOR SIZE	ANCHOR GRADE	STRUCTURE NUMBER	BRIDGE ELEMENT	PRODUCT NAME	EPOXY LOT NO.	

TABLE 00535-1

TEST NO.	TEST TYPE	INSTALLATION POSITION	EMBEDMENT DEPTH (in)	MIN. PULL-OUT FORCE (Lbs)	MEAS. PULL-OUT FORCE (Lbs)	VISUAL DISPLACEMENT	RESULTS
1							
2							
3							
4							
5							
6							
7							
8							
9							
10							

REMARKS:

CERTIFIED TECHNICIAN (PLEASE PRINT) AND CARD NUMBER	COMPANY NAME	SIGNATURE	DATE
CERTIFIED TECHNICIAN (PLEASE PRINT) AND CARD NUMBER	COMPANY NAME	SIGNATURE	DATE

RESIN BONDED ANCHOR PULL TEST

PROJECT NAME (SECTION) Demo Example					CONTRACT NUMBER C 12345	
CONTRACTOR OR SUPPLIER Contractor X			PROJECT MANAGER PM X		BID ITEM NUMBER 00535	TEST DATE 11/6/19
ANCHOR TYPE Rebar	ANCHOR SIZE 5	ANCHOR GRADE 60	STRUCTURE NUMBER ABC123	BRIDGE ELEMENT Rail	PRODUCT NAME HIT - RE 500	EPOXY LOT NO. Lot # 125

--	--	--	--	--	--	--	--

TABLE 00535-1							
TEST NO.	TEST TYPE	INSTALLATION POSITION	EMBEDMENT DEPTH (in)	MIN. PULL-OUT FORCE (Lbs)	MEAS. PULL-OUT FORCE (Lbs)	VISUAL DISPLACEMENT	RESULTS
1	DEMO	VERTICAL	6.00	22,300	21,000	YES	FAIL
2	DEMO	VERTICAL	6.00	22,300	22,500	NO	PASS
3	DEMO	VERTICAL	6.00	22,300	22,600	NO	PASS
4				Avg.	22,033		FAIL
5							
6							
7							
8							
9							
10							

REMARKS:
 DEMO Test No. 1-3 (3Anchors) failed due to visible deflection and not achieving min. pull out force. Average pull out force = 22, 033 lbs. Since $22,033 > 0.95 \times 22, 300$, anchor system may be retested.

CERTIFIED TECHNICIAN (PLEASE PRINT) AND CARD NUMBER Joe Bond	COMPANY NAME Contractor X	SIGNATURE	DATE
CERTIFIED TECHNICIAN (PLEASE PRINT) AND CARD NUMBER Bob Force	COMPANY NAME Agency	SIGNATURE	DATE

MECHANICAL ANCHOR PULL TEST

PROJECT NAME (SECTION)						CONTRACT NUMBER	
CONTRACTOR OR SUPPLIER			PROJECT MANAGER			BID ITEM NUMBER	TEST DATE
ANCHOR TYPE	ANCHOR SIZE	ANCHOR GRADE	STRUCTURE NUMBER	BRIDGE ELEMENT	PRODUCT NAME	LOT NO.	

TEST NO.	TEST TYPE	INSTALLATION POSITION	EMBEDMENT DEPTH (in)	MIN. PULL-OUT FORCE (Lbs)	MEAS. PULL-OUT FORCE (Lbs)	VISUAL DISPLACEMENT	RESULTS
1							
2							
3							
4							
5							
6							
7							
8							
9							
10							

REMARKS:

CERTIFIED TECHNICIAN (PLEASE PRINT) AND CARD NUMBER	COMPANY NAME	SIGNATURE	DATE
CERTIFIED TECHNICIAN (PLEASE PRINT) AND CARD NUMBER	COMPANY NAME	SIGNATURE	DATE

MECHANICAL ANCHOR PULL TEST

PROJECT NAME (SECTION) Demo Example					CONTRACT NUMBER C 12345	
CONTRACTOR OR SUPPLIER Contractor X			PROJECT MANAGER PM X		BID ITEM NUMBER 00534	TEST DATE 7/6/20
ANCHOR TYPE Screw	ANCHOR SIZE 5	ANCHOR GRADE 60	STRUCTURE NUMBER ABC123	BRIDGE ELEMENT Rail	PRODUCT NAME HIT - RE 500	LOT NO. Lot # 125

TEST NO.	TEST TYPE	INSTALLATION POSITION	EMBEDMENT DEPTH (in)	MIN. PULL-OUT FORCE (Lbs)	MEAS. PULL-OUT FORCE (Lbs)	VISUAL DISPLACEMENT	RESULTS
1	DEMO	VERTICAL	6.00	22,300	21,000	YES	FAIL
2	DEMO	VERTICAL	6.00	22,300	22,500	NO	PASS
3	DEMO	VERTICAL	6.00	22,300	22,600	NO	PASS
4				Avg.	22,033		FAIL
5							
6							
7							
8							
9							
10							

REMARKS:
 DEMO Test No. 1-3 (3Anchors) failed due to visible deflection and not achieving min. pull out force. Average pull out force = 22, 033 lbs. Since $22,033 > 0.95 \times 22,300$, anchor system may be retested.

CERTIFIED TECHNICIAN (PLEASE PRINT) AND CARD NUMBER Joe Bond	COMPANY NAME Contractor X	SIGNATURE	DATE
CERTIFIED TECHNICIAN (PLEASE PRINT) AND CARD NUMBER Bob Force	COMPANY NAME Agency	SIGNATURE	DATE

INSERT TAB

SECTION 4(A)
Source Compliance

SOURCE REVIEW AND PRODUCT COMPLIANCE TESTING FOR AGGREGATE

Source Review and Product Compliance testing of aggregate is separate from the Quality Control testing performed by the Contractor during aggregate production. These tests are used to evaluate the durability and soundness of the aggregate. In this section Source Review and Product Compliance are defined, the method of numbering sources is described and sampling frequency is outlined.

Source Number

ODOT Geo–Environmental Section assigns source identification numbers and monitors identified sources. For information see the following website:

www.oregon.gov/ODOT/GeoEnvironmental/Pages/Material-Source.aspx

Aggregate sources are identified by a three-part number. The first part indicates the county in which the source is located. The second part is the number of that source in the county. The third part is the ODOT region. For example: 22-001-2. The "22" is Linn County (22nd alphabetically), the "001" indicates that it is the first source identified in Linn County, and the "2" indicates that it is in Region 2.

SOURCE REVIEW

General

Source Review is the testing of unprocessed, uncrushed samples from an aggregate source for the purpose of evaluating the material in the source before it is processed. According to *Section 165.04* of the Standard Specifications a contractor may submit unprocessed aggregate from a maximum of two sources to the ODOT Central Laboratory for testing. This type of testing is optional and is only done at the Contractor's or supplier's request to assist in evaluating a source for possible use. The test results are for information only and cannot be used to meet Product Compliance test requirements.

Sampling

The Contractor or supplier's certified technician shall obtain five 50 lbs. samples of material. If possible, take each sample from a different area, or depth, of the source from which the Contractor or supplier intends to mine material. Samples shall come from areas that have enough raw materials to produce the quantities required by the project. The technician shall sample the material, properly bag and label it, see Section 4(C) "Laboratory Samples", fill out the Sample Data Sheet, form 734-4000; see Section 3, "Report Forms," for examples. Deliver the material to the Project Manager for review and submittal to the Central Materials Laboratory.

After aggregate production begins, the processed aggregate shall also be tested for product compliance.

PRODUCT COMPLIANCE

General

Once a Contractor or supplier establishes a crushing or screening operation the material produced is subject to testing according to the Project contract documents and Section 4(D) of the MFTP. The tests are used to determine compliance with soundness and durability specifications and can include Oregon degrade, abrasion, lightweight pieces, organics and plasticity index. Not all tests are performed on all aggregates. Refer to the specifications for the specific product.

Product Compliance testing used to determine compliance with the specifications must be performed by the ODOT Central Laboratory.

Sampling frequency is described below. Sample sizes are listed in Section 4(C) "Laboratory Samples". Product compliance testing is required for each aggregate product for each source used on a project.

Sampling

The Contractor or supplier's certified technician shall obtain two 50 lbs. samples of each aggregate product size for testing at the frequency listed below. The technician shall sample the material, properly bag and label it, see Section 4(C) "Laboratory Samples". Fill out the Sample Data Sheet form 734-4000; see Section 3, "Report Forms," for examples. Deliver the material to the Project Manager for review and submittal to the Central Materials Laboratory.

Sampling and Testing Frequency

AGGREGATE PRODUCTS - except Asphalt Aggregates: For aggregates which require product compliance testing, sample and submit for testing each separated size of aggregate produced at least once every 12 months. This includes but not limited to concrete aggregate, base aggregate, shoulder aggregate, and riprap aggregate.

ASPHALT AGGREGATE: For aggregate to be used in Asphalt Concrete Pavement, Emulsified Asphalt Concrete or Chip Seals, sample and submit each separated size of aggregate product to the PM for product compliance testing at the frequency shown in the Region tables located at the following website:

<https://www.oregon.gov/ODOT/Construction/Pages/Manual-of-Field-Test-Procedures.aspx>.

Sampling frequency varies from one sample per 5,000 Ton to one sample per 20,000 Ton each product produced.

Sources not listed in the tables shall be sampled and tested once per 5,000 Ton for each product produced. The ODOT Pavements Section will determine when the sampling frequency can be changed.

INSERT TAB

**SECTION 4(B)
Small Quantity Schedule**

FIELD TESTED MATERIALS SMALL QUANTITY GUIDELINE

This Guideline defines a method for accepting relatively small quantities of field tested materials without following the normal Quality Control sampling and testing frequencies. These quantities are usually less than the subplot amounts shown in the Field Tested Materials Acceptance Guide.

The Contractor may request, in writing, that normal QC sampling and testing of materials be waived for the quantities listed in the table below. The written request should clearly identify the equipment and process proposed before commencement of the work.

The Project Manager has the option to waive normal QC sampling and testing on the basis of one or more of the following conditions, if the Contractor submits the appropriate documentation with their request. Aggregate Product Compliance testing or documentation (Section 4A) shall be included with the submitted request. All asphalt cement products require a certificate of compliance.

- (1) If similar material from the same source has been accepted for use on ODOT projects within the past two years, and was found satisfactory under the Department's QA Program. Include the QC test data with the request.
- (2) Provide a Quality Compliance Certificate verifying that the material conforms to the contract requirements.
- (3) Provide other information indicating, by what method or workmanship that the Contractor will assure that all the contract requirements will be met.
- (4) For Section 00330 (Earthwork) provide a minimum of one Deflection test (TM 158) per area, performed by a ODOT Certified Density Technician (CDT). The Contractor's written request must identify the distinct work areas that small quantity acceptance is requested.
- (5) For section 00440, Small Quantity usage is not allowed for Structural Items.
- (6) For Section 00745 (ACP, Statistical Acceptance), acceptance shall be based on 00745.17 or on QC and QA data for the same Mix Design used on other projects within the past 12 months.
- (7) For Sections 00495, 00510, 0A596, 0B596 and 0C596 Small Quantity usage only applies to Quality Control Testing and sampling during Aggregate Production.

The Project Manager will report the basis of acceptance for the materials used in the project documents, including references to the appropriate test results and attachments.

See next page for Small Quantity Table.

Small Quantity Table

Section	Type of Material	Approximate Quantity
00330	Earthwork (Embankment)	500 yd ³
00330	Earthwork (Excavation)	500 yd ²
00345 & 00346	Lime & Cement Treated Subgrade	2000 yd ²
00390 & 00395	RipRap & Rock Gabions	100 yd ³
00405	Ditch & Trench Excavation, Bedding and Backfill	50 yd ³
00440	Commercial Grade Concrete (Non-Structural Items)	50 yd ³
00495	Trench Resurfacing	500 Ton
00510	Structure Excavation and Backfill	500 Ton
0A596, 0B596 & 0C596	Retaining Walls	500 Ton
00641 & 00642	Aggregate Sub-base, Base & Shoulders	2000 Ton
00680	Stockpiled Aggregate	2000 yd ³
00730	Asphalt Tack Coat	50 Ton
00735	Emulsified Asphalt Concrete Pavement (includes asphalt cement)	2500 Ton
00745	Asphalt Concrete Pavement (Statistical Acceptance) (ACP-each Level) (includes asphalt cement).	2500 Ton

INSERT TAB

SECTION 4(C)
Laboratory Samples

SAMPLES FOR SUBMITTAL TO MATERIALS LABORATORY

General

When sampling materials for transmittal to a laboratory, place the samples in proper, secure containers with adequate labeling and submit with the appropriate paperwork.

Please use the following guidelines for samples that are submitted to the ODOT Central Materials Laboratory.

Although these guidelines are established for the ODOT Materials Laboratory, they are probably also appropriate for samples submitted to other laboratories.

Documentation

Submit a properly completed Sample Data Sheet (Form 734-4000) with all samples that are delivered to the ODOT Materials Laboratory. There are three different types of Sample Data Sheets: 734-4000 (Aggregates & Oil), 734-4000C (Concrete) and 734-4000NFTM (Non Field Tested Materials). The appropriate Sample Data Sheet must be used for the appropriate sample. Each sample should have its own Sample Data Sheet. **Do not** submit two types of samples (i.e. ¾”- ¼” and ¼”-0”) on one Sample Data Sheet. The Sample Data Sheet must be completed properly. Below is a list of information that must be included on the form for different types of samples. **If this information is missing the sample will not be accepted.**

Required on all Sample Data Sheets:

- Valid Expenditure Account (EA) or Con Number
- Class of Sample (i.e. “Source/Product Compliance”)
- Submitted by name and contact number
- Appropriate Project contact person and number (not the Project Manager)

Sample Data Sheet - (Form 734-4000)

- Used for submitting aggregate, asphalt/emulsion, and ACP samples

Aggregate Samples:

- Aggregate size (i.e. ¾”- ¼”)
- Source Number
- Use of material (i.e. “Base Rock”)

Asphalt/Emulsion Liquid Oil Samples:

- Grade of material (i.e. “PG 64-22”)
- Name of the oil manufacturer (i.e. “McCall”)
- Lot and Sublot number (i.e. “1-1” or “1-5”)

ACP Samples:

- Material
- Use of Material (i.e. “Level 3 ACP”)
- Mix Design Number (include in “Remarks/Special Requirements” section)

Sample Data Sheet for Concrete Cylinders - (Form 734-4000C)

- Used for submitting concrete cylinder samples
- Specified strength (i.e. “3300 psi”)
- Number of days to break the concrete cylinders (i.e. “7 days” or “28 days”)
- Date the concrete cylinders were cast (i.e. “September 30, 2015”)
- Field test results, including curing and capping methods

Sample Data Sheet (Non Field-Tested Materials) – (Form 734-4000NFTM)

- Used for submitting non-field tested materials (Rebar, wire, etc.)
- Certificate of Origin of Steel Materials (CMO) (for steel items only)
- Test Result certificate (for steel items only)
- Quality Compliance certificate (for steel items only)

Sample Containers

Securely attach an identification label to each sample or container which shows:

- Contract Number**
- Sample Data Sheet (Form 734-4000) Number**
- Source of Material**

It is also helpful to place a second identifying label inside of the container (bag or bucket) of aggregates or similar material, in the event that the outside label is lost. Do not place the Sample Data Sheet in the bag.

Aggregate Sample Containers

- Use canvas or other tear-proof bags. Fabric mesh must contain the fine materials in the sample.
- 5 gallon plastic buckets are also acceptable containers. Be sure that the lids are securely attached.
- The maximum weight of each sample container is 50 lb. Use additional containers if a larger quantity is being submitted. Properly label each container.
- Secure or tie bags with cord or strong string. **Do not use wire.**

Asphalt Cement Containers

- Use plastic containers with tight lids for emulsified asphalt cements. Tape the lid onto the container to prevent leakage.
- Use metal containers with tight lids for other asphalt cements.

Note: Ensure containers are labeled with the following information: Contract #, CON #, Date sample was obtained, Grade of Oil & Supplier and Lot and Sublot the sample represents.

Other Sample Containers

For other samples, use containers that will adequately contain the enclosed sample and will protect the sample from weather or other elements if needed.

REQUIRED SAMPLE SIZES

MATERIALS AND CONSTITUENTS	MIX DESIGN	QUALITY CONTROL OR PRODUCT COMPLIANCE
<p>SOIL</p> <p>TOPSOIL</p> <p>BASE AGGREGATE</p> <p>AGGREGATE SUB-BASE AGGREGATE</p> <p>CEMENT TREATED BASE</p> <p>AGGREGATE</p> <p>ROCK GABIONS & RIPRAP</p> <p>AGGREGATE</p> <p>MSE WALL BACKFILL MATERIAL (ALL TYPES)</p>	<p>250 lbs. - 5 bags</p>	<p>20 lbs. - 1 bag</p> <p>100 lbs. - 2 bags 100 lbs. - 2 bags</p> <p>150 lbs. - 3 bags</p> <p><i>[Maximum size of individual pieces 9"]</i>.</p> <p>150 lbs. - 3 bags</p>
<p>NOTE: Submit a completed Sample Data Sheet (Form 734-4000) with each sample. Include all the required information or the sample will not be accepted. (Properly label each container).</p> <p>See Section 4(A) for samples to be submitted for source/product compliance testing.</p>		

REQUIRED SAMPLE SIZES

<p>MATERIALS AND CONSTITUENTS</p>	<p>VERIFICATION OF CONTRACTOR MIX DESIGN</p>	<p>QUALITY CONTROL OR PRODUCT COMPLIANCE</p>
<p>ASPHALT CONCRETE PAVEMENT</p> <p>ASPHALT CEMENT</p> <p>ACP (OPEN GRADED) or POROUS ASPHALT CONCRETE (PAC)</p> <p>ASPHALT CEMENT</p> <p>EAC PAVEMENT</p> <p>EMULSIFIED ASPHALT CEMENT</p>	<p>If JMF verification is requested by ODOT, submit samples to the ODOT Materials Laboratory in Salem according to the guidelines set forth in the current “Contractor Mix Design Guidelines for Asphalt Concrete”. Use the guideline version that coincides with the date the contract was advertised.</p> <p>This document can be found on the ODOT website.</p>	<p>2 - 1 qt. metal containers</p> <p>2 - 1 qt. metal containers</p> <p>2 - 1 qt. plastic containers</p>
<p>NOTE: Submit a completed Sample Data Sheet (Form 734-4000) with each sample. Include all the required information or the sample will not be accepted. (Properly label each container).</p> <p>See Section 4(A) for samples to be submitted for source/product compliance testing</p>		

INSERT TAB

**SECTION 4(D)
Field Tested Materials
Guide**

HOW TO USE THE FIELD TESTED MATERIALS ACCEPTANCE GUIDE

This guide summarizes the testing requirements for various materials used in the construction of ODOT projects. It indicates what tests must be performed, who must perform them, and how frequently they must be performed. It includes materials which are sampled and tested in the field and materials which are field sampled but sent elsewhere for testing. When a contract requires Quality Control (QC) by the Contractor, samples that must be sent elsewhere for testing are delivered to the Project Manager along with the Sample Data Sheet (Form 734-4000). Examples of this and other test report forms are in Section 3 of this manual.

Materials in this guide are listed in the numerical order of the Standard Specifications and the project special provisions. To find the testing requirements for a particular material, first determine what it will be used for and then refer to the appropriate Specifications Section for that product. For example, to look up testing requirements for aggregate to be used in asphalt concrete paving, refer to Section 00745.

Definitions

SOURCE REVIEW/PRODUCT COMPLIANCE TESTING – Refer to Section 4(A) for additional explanation. Certain QC tests on aggregates fall into this category. They are identified in this section by the words “Product Compliance.”

SAMPLE SIZES – Refer to Section 4(C) for guidance on material sample sizes, containers, and labeling. Although designed for the ODOT Central Materials Laboratory (ODOT-CML), it is a good guide for samples being sent to any laboratory.

ASPHALT CONCRETE MIX DESIGNS – If the ODOT-CML is preparing the AC mix design, submit samples of the materials shown in Section 4(C) of this manual.

TYPES OF TESTS

The following types of tests will be performed by the Contractor or Engineer on materials and products required for contract work:

1. **Source Review** – This test type is addressed in Section 4(A) of this Manual.

The Engineer will test unprocessed material from an aggregate source, if requested by the Contractor, to provide information about the quality of material. Tests will involve degradation, soundness, and abrasion, but may involve other tests. Favorable test results do not imply that processed material from the source will comply with specifications after it is processed as required for the project.

2. **Product Compliance** – This test type is addressed in Section 4(A) of this Manual. The Engineer will test processed material if process control testing indicates that the processed material meets the contract quality requirements. Tests will involve degradation, soundness, abrasion, and lightweight pieces, but may involve other tests. The material shall not be incorporated into the project unless Product Compliance tests show favorable results.

3. **Quality Control** – The Contractor will perform quality control testing as described in Section 2 and specified in 4(D) of this Manual or as modified by the Special Provisions or Supplemental Standard Specifications.

4. **Verification** – The Engineer will perform Verification testing as described in Section 2 and specified in Section 4(D) of this Manual. **Note: The required 1 per 10 subplot testing of Quality Control by the Region QA is considered a minimum frequency and testing may be increased when deemed necessary by the engineer.** These tests provide the basis for the Engineer's decision on acceptance of materials and products. If Independent Assurance is to be done on a material, a split of the Verification sample will be given to the Contractor for testing.

5. **Independent Assurance** – Where Independent Assurance involves testing, the Engineer will evaluate test results from split samples to assure that Contractor test results meet required parameters.

6. **Visual** – Visual Inspection: Examination and assessment of construction materials, by **OBSERVATION**, to determine if the materials appear to meet the contract requirements and are acceptable for incorporation into ODOT construction projects. Visual inspection, when stated in the contract, is a method generally used by the Project Inspector in lieu of normal sampling and testing of field tested materials as defined in section 00165.00 of the Standard Specifications to document quality. Supporting documentation for visual acceptance is, at a minimum, a field inspection report. Consult the construction contract for other acceptance document requirements.

FIELD TESTED MATERIALS ACCEPTANCE GUIDE

(Revised November 2020)

Same Frequency for all Tests (Minimums)

MATERIAL AND OPERATION	DESCRIPTION OF TEST	TEST METHOD			FORM 734-	QUALITY ASSURANCE			
		ODOT	WAQTC	AASHTO		Contractor Quality Control	Project Manager	Region Quality Assurance	Materials Laboratory
SECTION 00330 - EARTHWORK									
Establishing Maximum Density (for Compaction)	Density Curve			T 99	3468				
	Bulk Specific Gravity			T 85	3468	1/Soil type		1/Project	
	Family of Curves			R 75	3468FC				
	Deflection Testing	TM 158			1793S	1 test per 3 ft. in depth			1 test per 10 QC Tests per Table 00330-1
Compaction	Nuclear Gauge			T 310	1793S	See Table 00330-1 Below			
	Coarse Particle Correction			T 99	1793S				
	Deflection Testing	TM 158			1793S				

TABLE 00330-1 Frequency of Quality Control Testing (English)

Individual Areas	Under 3500 yd ² or yd ³	Over 3500 yd ² or yd ³
Existing Ground Surface	1 test per 1000 yd ²	1 test per 3000 yd ²
Embankments	1 test per 500 yd ³	1 test per 3000 yd ³
Excavations and Finished Subgrade	1 test per 1000 yd ²	1 test per 3000 yd ²
Gradation		Visual See Section 00330.16(b)
Deflection Testing	TM 158	1 per Layer

Contractor must demonstrate, by compaction testing or acceptable visual means, that the material, equipment, and process used for compaction achieves the specification requirements. If the material, equipment, or process changes, or if other conditions indicate a non-specification product, the Contractor must re-demonstrate that specification requirements are being achieved.

Imported Topsoil (See Section 01040.14(b))	Compliance		4000	See Section 4C 1/Source & 1/Type of Soil	Submit to Lab

FIELD TESTED MATERIALS ACCEPTANCE GUIDE				(Revised November 2020)			Same Frequency for all Tests (Minimums)		
MATERIAL AND OPERATION	DESCRIPTION OF TEST	TEST METHOD			FORM 734-	QUALITY ASSURANCE			
		ODOT	WAQTC	AASHTO		Contractor Quality Control	Project Manager	Region Quality Assurance	Materials Laboratory
SECTION 00331 - SUBGRADE STABILIZATION Aggregate backfill	Material must meet the requirements of Section 00331.10								
						Visual			
Water	Material must meet the requirements of Section 00340								
Compaction	Material must meet the requirements of Section 00331								
						Visual			
SECTION 00332 - SURFACING STABILIZATION Aggregate Base	Material must meet the requirements of Section 00332.10								
						Visual			
Compaction	Material must meet the requirements of Section 00332								
						Visual			
SECTION 00333 - AGGREGATE DITCH LINING Aggregate	Sampling Reducing Sieve Analysis								
					R 90 R 76 T 27/T 11				
						1/Project or 1/Source			
				1792					

FIELD TESTED MATERIALS ACCEPTANCE GUIDE				(Revised November 2020)				Same Frequency for all Tests (Minimums)			
MATERIAL AND OPERATION	DESCRIPTION OF TEST	TEST METHOD			FORM 734-734-	QUALITY ASSURANCE					
		ODOT	WAQTC	AASHTO		Contractor Quality Control	Project Manager	Region Quality Assurance	Materials Laboratory		
SECTION 00344 - TREATED SUBGRADE											
Granular Quicklime	Sieve Analysis Calcium Hydroxide Content in lime			T 27 T 219	4000	1/Project or 1/Source	Submit to Lab			1/Project or 1/Source	
Hydrated Lime Calcium Chloride Sodium Chloride	Materials must meet the requirements of Section 00344.10 and Test Results Certificate provided according to Section 00165.35(a)										
Portland Cement Water	Material must meet the requirements of Section 02010 Material must meet the requirements of Section 00340										
Establishing Maximum Density	Density Curve Maximum Specific Gravity			T 99	3468	See Table 00344-1 Below for Testing Frequency					1/Project and 1 Test per 10 QC tests per Table 00344-1
Compaction	Deflection Testing Nuclear Gauge Coarse Particle Correction	TM 158 TM 158		T 310 T 99	1793S 1793S						
TABLE 00344-1 Frequency of Quality Control Testing											
Individual Areas					Under 3500 yd²			Over 3500 yd²			
Finished Subgrade					1 test per 1000 yd ²			1 test per 3000 yd ²			

FIELD TESTED MATERIALS ACCEPTANCE GUIDE				(Revised November 2020)		Same Frequency for all Tests (Minimums)			
MATERIAL AND OPERATION	DESCRIPTION OF TEST	TEST METHOD			FORM 734-	QUALITY ASSURANCE			
		ODOT	WAQTC	AASHTO		Contractor Quality Control	Project Manager	Region Quality Assurance	Materials Laboratory
SECTION 00360 - Drainage Blankets									
Granular Drainage Blanket	Sampling Reducing Sieve Analysis			R 90 R 76 T 27/T 11	1792	1/sublot minimum 1/Source per Project	A sublot equals 1000 Tons		
Sand Drainage Blanket	Sampling Reducing Sieve Analysis			R 90 R 76 T 27/T 11	1792				
Establishing Maximum Density	Density Curve			T 99	3468	1/Source and Type		1/Project	
Compaction	Bulk Specific Gravity			T 85	3468				
	Deflection Testing		TM 158		1793S	1 test per 3 ft. in depth			
	Deflection Testing Nuclear Gauge Coarse Particle Correction		TM 158	T 310 T 99	1793S	See Table 00360-1 Below		1 Test per 10 QC Tests per Table 00360-1	
TABLE 00360-1 Frequency of Quality Control Testing									
Individual Areas					Under 3500 yd²				Over 3500 yd²
Existing Ground Surface					1 test per 1000 yd ²				1 test per 3000 yd ²
Finished Surfaces					1 test per 1000 yd ²				1 test per 3000 yd ²

FIELD TESTED MATERIALS ACCEPTANCE GUIDE				(Revised November 2020)				Same Frequency for all Tests (Minimums)			
MATERIAL AND OPERATION	DESCRIPTION OF TEST	TEST METHOD			FORM 734-	QUALITY ASSURANCE					
		ODOT	WAQTC	AASHTO		Contractor Quality Control	Project Manager	Region Quality Assurance	Materials Laboratory		
SECTION 00390 - RIPRAP PROTECTION											
Fill Material & Riprap											
Gradation See 00390.11(c-1)	Degradation Soundness Apparent Specific Gravity & Absorption	TM 208		T 104 T 85	4000 1825	See Section 4(A)	Visual Submit to Lab				See Section 4(A)
Filter Blanket							Visual				
Gradation See 00390.13											
Grouted Riprap											
Sand	Sampling Reducing Sieve Analysis			R 90 R 76 T 27/T 11	1792	1/Project					
	Soundness Lightweight Pieces			T 104 T 113	4000	See Section 4(A)	Submit to Lab				See Section 4(A)
Portland Cement	Material must meet the requirements of Section 02010										

FIELD TESTED MATERIALS ACCEPTANCE GUIDE				(Revised November 2020)		Same Frequency for all Tests (Minimums)				
MATERIAL AND OPERATION	DESCRIPTION OF TEST	TEST METHOD			FORM 734-734-	QUALITY ASSURANCE				
		ODOT	WAQTC	AASHTO		Contractor Quality Control	Project Manager	Region Quality Assurance	Materials Laboratory	
SECTION 00396 - SHOTCRETE SLOPE STABILIZATION										
Aggregate Production and Mixture										
(1) QAE may waive after 5 sublots/shifts	Sampling Reducing			R 90 R 76		1/Sublot & Start of Production	Submit to Central Lab	1 per 10 Sublots		See Section 4(A)
	(2)(3) Sieve Analysis			T 27/T 11 T 27/T 11						
	(3) Fineness Modulus			T 176						
(2) Coarse Aggregate (See Section 02690.20)	(1)(2) Wood Particles	TM 225				See Section 4A	Submit to Central Lab			
	(3) Sand Equivalent									
(3) Fine Aggregate (See Section 02690.30)	Soundness			T 104 T 96	4000	Start of production and				
	Abrasion									
	Degradation Lightweight Pieces Organics	TM 208		T 113 T 21						
Portland Cement Admixtures	(2) Dry Rodded Unit Weight			T 19	1825 1825C	Two Test Panels per Mix Design & Two Panels per days Production See Section 00396.14(a)2				
	(2)(3) Bulk Specific Gravity & Absorption			T 84 & T 85	1825					
Mixing Water						Submit to Central Lab				
Production Testing (See Section 00396.14)	(S) Test Panel					1/Set Cores per Test panel				
(S) 3 Cores minimum per Panel						Submit to Central Lab				
Compression Test Cores	Strength			T 22	4000C					

FIELD TESTED MATERIALS ACCEPTANCE GUIDE

(Revised November 2020)

Same Frequency for all Tests (Minimums)

MATERIAL AND OPERATION	DESCRIPTION OF TEST	TEST METHOD			FORM 734-	QUALITY ASSURANCE		
		ODOT	WAQTC	AASHTO		Contractor Quality Control	Project Manager	Region Quality Assurance
SECTION 00405 - TRENCH EXCAVATION, BEDDING, AND BACKFILL								
TRENCH FOUNDATION (Excavation Below Grade Only)								
Selected general backfill							Visual	
Selected granular backfill							Visual	
Selected stone backfill							Visual	
Other approved material							Visual	
Establishing Maximum Density	Density Curve			T 99	3468		1/Soil Type or Aggregate Gradation	
	Bulk Specific Gravity			T 85	3468			
	Family of Curves			R 75	3468FC			
	Nuclear Gauge Coarse Particle Correction			T 310 T 99	1793S		1 test per 300 ft. of Trench	

Contractor must demonstrate, by compaction testing or acceptable visual means, that the material, equipment, and process used for compaction achieves the specification requirements. If the material, equipment, or process changes, or if other conditions indicate a non-specification product, the Contractor must re-demonstrate that specification requirements are being achieved.

FIELD TESTED MATERIALS ACCEPTANCE GUIDE				(Revised November 2020)		Same Frequency for all Tests (Minimums)			
MATERIAL AND OPERATION	DESCRIPTION OF TEST	TEST METHOD			FORM 734-	QUALITY ASSURANCE			
		ODOT	WAQTC	AASHTO		Contractor Quality Control	Project Manager	Region Quality Assurance	Materials Laboratory
SECTION 00405 - TRENCH EXCAVATION, BEDDING, AND BACKFILL (CONTINUED)									
Pipe Zone Material		Use the Listed Material requirements under Bedding							
Flexible Pipe	Rigid Pipe: Aggregate Base 1" - 0 or 3/4" - 0 Aggregate (See Section 02630.10)	Sampling							
		Reducing Sieve Analysis		R 90 R 76 T 27	1792	1/Source or Gradation			
Rigid Pipe: Commercial 1" - 0 or 3/4" - 0 Aggregate							Visual		
Establishing Maximum Density (¹) Method "A" & ODOT TM 223 for Dense Graded Base Aggregate	Density Curve Bulk Specific Gravity Coarse Particle Correction				3468	1/Source or Aggregate Gradation			
					3468				
					1793B	1 Test per 300 ft. of Trench and every 1.5 ft. of Fill			
Compaction		Nuclear Gauge		T 310					
Contractor must demonstrate, by compaction testing or acceptable visual means, that the material, equipment, and process used for compaction achieves the specification requirements. If the material, equipment, or process changes, or if other conditions indicate a non-specification product, the Contractor must re-demonstrate that specification requirements are being achieved.									

FIELD TESTED MATERIALS ACCEPTANCE GUIDE				(Revised November 2020)		Same Frequency for all Tests (Minimums)				
MATERIAL AND OPERATION	DESCRIPTION OF TEST	TEST METHOD			FORM 734-734-	QUALITY ASSURANCE				
		ODOT	WAQTC	AASHTO		Contractor Quality Control	Project Manager	Region Quality Assurance	Materials Laboratory	
SECTION 00430 - SUBSURFACE DRAINS										
Granular Drain Backfill Material	Sampling Reducing Sieve Analysis	R 90 R 76 T 27	TM 208	See section 405 for compaction requirements	1792	A Sublot equals 1000 Tons	1/Sublot (Minimum 1/ Project)	Submit To Lab	See Section 4A	
					4000					
Special Filter Material See Section 00430.46(a)	Compaction								See Section 4A	
SECTION 00440 - COMMERCIAL GRADE CONCRETE										
Mixture	Sampling Air Content Density (Unit Weight) Yield Slump Concrete Temperature	TM 2	T 152 T 121 T 121 T 119 T 309	See section 405 for compaction requirements	3573WS or 4000 C		(S) 1 per each set of cylinders			
Modifiers										
Admixtures										
Portland Cement										
Structural Items	Strength	T 22 & T 23		See section 405 for compaction requirements	4000C		(M)(S) 1 Set / Day Minimum			
Except Visual Acceptance Items (See section 00440.14(a))	Strength	T 22 & T 23		See section 405 for compaction requirements	4000C		(M) (S) 1 Set/20 yd ³ Cumulative (Maximum 1 Set/day)			
(S) 1 Set Represents a minimum of 3 Cylinders										
(M) Per Mix Design & Source										

FIELD TESTED MATERIALS ACCEPTANCE GUIDE					Same Frequency for all Tests (Minimums)					
MATERIAL AND OPERATION	DESCRIPTION OF TEST	TEST METHOD			FORM 734-734-	Contractor Quality Control	QUALITY ASSURANCE			
		ODOT	WAQTC	AASHTO			Project Manager	Region Quality Assurance	Materials Laboratory	
SECTION 00442 - CONTROLLED LOW STRENGTH MATERIALS (CLSM)										
CLSM Mixture	Mix Proportions Trial Batch Strength					1/Project or Source				
				T 22 & T 23	4000C					
Modifiers		Material must meet the requirements of Section 02030								
Admixtures		Material must meet the requirements of Section 02040								
Portland Cement		Material must meet the requirements of Section 02010								
SECTION 00445 - SANITARY, STORM, CULVERT, SIPHON, AND IRRIGATION PIPE - INCLUDED WITH SECTION 00405										
Trench Work										
Excavation, bedding, pipe zone and trench backfill		See Section 00405 for pipes less than 72"								
Excavation, bedding, pipe zone and trench backfill		See Section 00510 for pipes greater than 72"								
Concrete Blocks		Material must meet the requirements of Section 00440								

FIELD TESTED MATERIALS ACCEPTANCE GUIDE				Same Frequency for all Tests (Minimums)				
MATERIAL AND OPERATION	DESCRIPTION OF TEST	TEST METHOD			FORM 734-	QUALITY ASSURANCE		
		ODOT	WAQTC	AASHTO		Contractor Quality Control	Project Manager	Region Quality Assurance
SECTION 00450 - STRUCTURAL PLATE SHAPED STRUCTURES								
Commercial Grade Concrete in appurtenances		Material must meet the requirements of Section 00440						
Trench Work								
Excavation and Backfill		Operations must meet the requirements of Section 00510						
Trenches in Unstable Areas								
Granular Structural Backfill		Material must meet the requirements of Section 00510						
Establishing Maximum Density (¹) Method "A"	Density Curve				(¹) T 99	3468 B	1/Aggregate Gradation and Source	
	Bulk Specific Gravity Coarse Particle Correction	TM 223			T 85			
	Nuclear Gauge				T 310	1793 B	1 Test per 100 ft. and 1 ft. of fill	
Compaction		Material and Operation must meet the requirements of Section 00510.48(d)						
Structure Backfill (Section 00450.46)		Material and Operation must meet the requirements of Section 00510.48(d)						
SECTION 00459 - CAST IN PLACE CONCRETE PIPE								
Concrete		Material must meet the requirements of Section 00540, with acceptance in accordance with Section 00540.17						
Backfill Material		Material must meet the requirements of Section 00405.14 and be incorporated into the project in accordance with Section 00405.46						

FIELD TESTED MATERIALS ACCEPTANCE GUIDE				(Revised November 2020)			Same Frequency for all Tests (Minimums)		
MATERIAL AND OPERATION	DESCRIPTION OF TEST	TEST METHOD			FORM 734-	Contractor Quality Control	QUALITY ASSURANCE		
		ODOT	WAQTC	AASHTO			Project Manager	Region Quality Assurance	Materials Laboratory
SECTION 00460 - PAVED CULVERT END SLOPES									
Commercial Grade Concrete		<i>Material must meet the requirements of Section 00440</i>							
SECTION 00470 - MANHOLES, CATCH BASINS AND INLETS									
Commercial Grade Concrete		<i>Material must meet the requirements of Section 00440</i>							
Base Drain Backfill		<i>Material must meet the requirements of Section 00470.17</i>							
Excavation, Backfill and Foundation Stabilization		<i>Material must meet the requirements of Section 00405</i>							
SECTION 00480 - DRAINAGE CURBS									
Commercial Grade Concrete		<i>Material must meet the requirements of Section 00440</i>							
Dense Graded ACP Mixture Level 2, (1/2")		<i>Material must meet the requirements of Section 00744</i>							

FIELD TESTED MATERIALS ACCEPTANCE GUIDE				(Revised November 2020)			Same Frequency for all Tests (Minimums)		
MATERIAL AND OPERATION	DESCRIPTION OF TEST	TEST METHOD			FORM 734-	QUALITY ASSURANCE			
		ODOT	WAQTC	AASHTO		Contractor Quality Control	Project Manager	Region Quality Assurance	Materials Laboratory
SECTION 00490 - WORK ON EXISTING SEWERS AND STRUCTURES									
Commercial Grade Concrete		Material must meet the requirements of Section 00440							
High Early Strength Concrete		Material must meet the requirements of Section 00440, but cement contents adjusted according to 00490.11							
Backfill Operations		Backfill Excavations according to section 405							
Filling Abandoned Pipes, Manholes and Catch Basins (See section 00490.44)									
Backfill Operations (Roadway)		Material must meet the requirements of Section 2630							
Establishing Maximum Density (¹) Method "A"	Density Curve			(¹) T 99					
	Bulk Specific Gravity Coarse Particle Correction	TM 223		T 85			1/Aggregate Gradation and Source		
Compaction	Nuclear Gauge			T 310			1 Test per 100 ft. and every 1.5' of Fill		
Backfill Operations Landscaped or Unimproved Roadways		Material must meet the requirements of Section 00330.13							
Top 1.0' of Backfill Region		Material must meet the requirements of Section 00330.11							
SECTION 00495 - TRENCH RESURFACING									
Resurfacing Materials		See Section 00495.40 for Material Requirements							

FIELD TESTED MATERIALS ACCEPTANCE GUIDE				(Revised November 2020)			Same Frequency for all Tests (Minimums)		
MATERIAL AND OPERATION	DESCRIPTION OF TEST	TEST METHOD			FORM 734-	QUALITY ASSURANCE			
		ODOT	WAQTC	AASHTO		Contractor Quality Control	Project Manager	Region Quality Assurance	Materials Laboratory
SECTION 00510 - STRUCTURE EXCAVATION AND BACKFILL									
Soils, Soil/Aggregate Mixtures and Graded Aggregates									
Granular Structure Backfill (See Section 02630.10)	Sampling Reducing (¹) Sieve Analysis Fracture (Method 1) Sand Equivalent			R 90 R 76 T 27 T 335 T 176	1792	1/Sublot (Minimum 1/Project)			
Product Compliance	Abrasion Degradation Plasticity Index Sieve Analysis	TM 208		T 96 T 90 T 11	4000	See Section 4C 1/Source	Submit to Lab		Minimum 1/Project or 1/Source
Establishing Maximum Density (²) Method "A" & ODOT TM 223 for Dense Graded Base Aggregate	Density Curve Bulk Specific Gravity			(2) T 99 T 85	3468 3468	1/Soil type or Aggregate Gradation			
Compaction	Coarse Particle Correction Nuclear Gauge			T 99 T 310	1793B	1/100 yd ³ minimum 1/project			
Contractor must demonstrate, by compaction testing or acceptable visual means, that the material, equipment, and process used for compaction achieves the specification requirements. If the material, equipment, or process changes, or if other conditions indicate a non-specification product, the Contractor must re-demonstrate that specification requirements are being achieved.									

FIELD TESTED MATERIALS ACCEPTANCE GUIDE				(Revised November 2020)			Same Frequency for all Tests (Minimums)										
MATERIAL AND OPERATION	DESCRIPTION OF TEST	TEST METHOD			FORM 734-	QUALITY ASSURANCE											
		ODOT	WAQTC	AASHTO		Contractor Quality Control	Project Manager	Region Quality Assurance	Materials Laboratory								
SECTION 00510 - STRUCTURE EXCAVATION AND BACKFILL (CONTINUED)																	
Soils, Soil/Aggregate Mixtures and Graded Aggregates																	
Granular Wall Backfill (See Section 02630.11) (1) Perform a minimum of 3 tests QL's required	Sampling Reducing (1) Sieve Analysis Fracture (Method 2)	TM 208	R 90 R 76 T 27 T 335		1792	1/Sublot (Minimum 1/Project)											
										Product Compliance	TM 208	T 96		4000	See Section 4C 1/Source	Submit to Lab	Minimum 1/Project or 1/Source
Note: Compaction must meet the requirements of section 00330.43C																	
Contractor must demonstrate, by compaction testing or acceptable visual means, that the material, equipment, and process used for compaction achieves the specification requirements. If the material, equipment, or process changes, or if other conditions indicate a non-specification product, the Contractor must re-demonstrate that specification requirements are being achieved.																	

FIELD TESTED MATERIALS ACCEPTANCE GUIDE				(Revised November 2020)			Same Frequency for all Tests (Minimums)		
MATERIAL AND OPERATION	DESCRIPTION OF TEST	TEST METHOD			FORM 734-	QUALITY ASSURANCE			
		ODOT	WAQTC	AASHTO		Contractor Quality Control	Project Manager	Region Quality Assurance	Materials Laboratory
SECTION 00512 - DRILLED SHAFTS									
Aggregate Production									
(1) QAE may waive after 5 sublots/shifts	Sampling Reducing			R 90 R 76					
	(2)(3)(4) Sieve Analysis			T 27/T 11 T 27/T 11	1792	1/Sublot & Start of Production	1 per 10 Sublots		
(2) Perform a minimum of 3 tests, QL's required	(4) Fineness Modulus			T 176	1792				
	(1)(3) Wood Particles	TM 225							
(3) Coarse Aggregate (See Section 02690.20)	(4) Sand Equivalent								
	Soundness Abrasion			T 104 T 96	4000				See Section 4(A)
(4) Fine Aggregate (See Section 02690.30)	Degradation Lightweight Pieces Organics	TM 208		T 113 T 21	4000	See Section 4A	Submit to Lab		
	(3) Dry Rodded Unit Weight			T 19	1825 1825C				
Portland Cement Modifiers Admixtures	Gravity & Absorption			T 84 & T 85	1825	Start of production and when changes in aggregate occurs			
		Materials must meet the requirements of Section 02001.10							
Drilling Slurry		Materials must meet the requirements of Section 00512.14 & 00512.43(g)							
		Slurry material must meet the requirements of Section 00512.14 & 00512.43(g)							
Grout		Material must meet the requirements of Section 02080							
		Material must meet the requirements of Section 02080							
Mixing Water		Material must meet the requirements of Section 02020							
		Material must meet the requirements of Section 02020							

FIELD TESTED MATERIALS ACCEPTANCE GUIDE

(Revised November 2020)

Same Frequency for all Tests (Minimums)

MATERIAL AND OPERATION	DESCRIPTION OF TEST	TEST METHOD			FORM 734-734-	QUALITY ASSURANCE										
		ODOT	WAQTC	AASHTO		Contractor Quality Control	Project Manager	Region Quality Assurance	Materials Laboratory							
SECTION 00512 - DRILLED SHAFTS (CONTINUED)																
Portland Cement Concrete	Sampling Slump Concrete Temperature Density (Unit Weight) Yield Water/Cement Ratio Strength	TM 2					QA Testing									
									(M) (S) 1 per Shaft and Test at minimum frequencies according to table 00512-1. Review specs.	<u>Projects under 100 yd³ all classes</u> 1/Project representing all classes of PCC						
											3573WS or 4000C	<u>Projects over 100 yd³ all classes</u> 1/500 yd ³ per class minimum 1/class				
													4000C			
<p>(S) 1 Set Represents a minimum of 3 Cylinders</p> <p>(M) Per Mix Design & Source</p>																
<p>TABLE 00512-1 Frequency of Quality Control Testing</p> <p><i>Minimum frequencies per Class of concrete based on daily production records.</i></p> <table border="1" style="width: 100%;"> <thead> <tr> <th>Production</th> <th>Frequencies</th> </tr> </thead> <tbody> <tr> <td>0 to 100 yd³ on a single day</td> <td>1 Set each day</td> </tr> <tr> <td><u>Quantity Over 100 yd³</u> 100 to 600 yd³ on a single day</td> <td>1 Set per each 100 yd³ or portion thereof</td> </tr> <tr> <td>over 600 yd³ on a single day</td> <td>1 Set per each 200 yd³ or portion thereof after reaching 600 yd³</td> </tr> </tbody> </table>									Production	Frequencies	0 to 100 yd ³ on a single day	1 Set each day	<u>Quantity Over 100 yd³</u> 100 to 600 yd ³ on a single day	1 Set per each 100 yd ³ or portion thereof	over 600 yd ³ on a single day	1 Set per each 200 yd ³ or portion thereof after reaching 600 yd ³
Production	Frequencies															
0 to 100 yd ³ on a single day	1 Set each day															
<u>Quantity Over 100 yd³</u> 100 to 600 yd ³ on a single day	1 Set per each 100 yd ³ or portion thereof															
over 600 yd ³ on a single day	1 Set per each 200 yd ³ or portion thereof after reaching 600 yd ³															

FIELD TESTED MATERIALS ACCEPTANCE GUIDE				(Revised November 2020)		Same Frequency for all Tests (Minimums)		
MATERIAL AND OPERATION	DESCRIPTION OF TEST	TEST METHOD			FORM 734-	QUALITY ASSURANCE		
		ODOT	ASTM	AASHTO		Contractor Quality Control	Project Manager	Region Quality Assurance
SECTION 00535 - POST-INSTALLED ANCHOR SYSTEMS								
Resin Bonded Anchor System								
Anchor Bolts, reinforcing steel and resin (Polyester, vinyl ester or epoxy)						A Sublot equals 50 Anchors		
Anchor Installation								
Demonstration Testing (See Section 00535.45(a))	Strength of Anchors in Concrete Elements	E 488			5189		One demonstration Test includes 3 anchors (Resin shall be from same lot)	Visual
Production Testing (See Section 00535.45(b))	Strength of Anchors in Concrete Elements	E 488			5189		^(A) 1 Anchor/Sublot or portion thereof (Minimum 1/Shift)	Visual per Sublot
^(A) Anchor testing is required per critical element identified in the Special Provisions or Plan Drawings.								

FIELD TESTED MATERIALS ACCEPTANCE GUIDE				(Revised November 2020)		Same Frequency for all Tests (Minimums)			
MATERIAL AND OPERATION	DESCRIPTION OF TEST	TEST METHOD			FORM 734-	Contractor Quality Control	QUALITY ASSURANCE		
		ODOT	ASTM	AASHTO			Project Manager	Region Quality Assurance	Materials Laboratory
SECTION 00535 - POST-INSTALLED ANCHOR SYSTEMS (continued)									
Mechanical Anchor System									
Mechanical Anchors							A Sublot equals 50 Anchors		
<i>Materials must meet the requirements of Section 00535.10(b)</i>									
Anchor Installation									
Demonstration Testing (See Section 00535.45(a))	Strength of Anchors in Concrete Elements		E 488		5292	One demonstration Test includes 3 anchors	Visual		
Production Testing (See Section 00535.45(b))	Strength of Anchors in Concrete Elements		E 488		5292	(A) 1 Anchor/Sublot or portion thereof (Minimum 1/Shift)	Visual per Sublot		
(A) Anchor testing is required per critical element identified in the Special Provisions or Plan Drawings.									

FIELD TESTED MATERIALS ACCEPTANCE GUIDE				(Revised November 2020)			Same Frequency for all Tests (Minimums)		
MATERIAL AND OPERATION	DESCRIPTION OF TEST	TEST METHOD			FORM 734-	QUALITY ASSURANCE			
		ODOT	WAQTC	AASHTO		Contractor Quality Control	Project Manager	Region Quality Assurance	Materials Laboratory
SECTION 00540 - STRUCTURAL CONCRETE									
Aggregate Production									
(1) QAE may waive after 5 sublots/shifts	Sampling Reducing			R 90 R 76					
	(2)(3)(4) Sieve Analysis			T 27/T 11 T 27/T 11	1792	1 per 10 Sublots			
(2) Perform a minimum of 3 tests, QL's required	(4) Fineness Modulus			T 176	1792				
	(1)(3) Wood Particles	TM 225							
(3) Coarse Aggregate (See Section 02690.20)	(4) Sand Equivalent								
	Soundness Abrasion			T 104 T 96	4000		Submit To Lab		See Section 4A
(4) Fine Aggregate (See Section 02690.30)	Degradation	TM 208		T 113 T 21	4000		See Section 4A		
	Lightweight Pieces Organics								
Portland Cement Modifiers Admixtures	(3) Dry Rodded Unit Weight			T 19	1825 1825C				
	(3)(4) Bulk Specific Gravity & Absorption			T 84 & T 85	1825		Start of production and when changes in aggregate occurs		
Materials must meet the requirements of Section 02001.10									
Mixing Water									
Material must meet the requirements of Section 02020									

FIELD TESTED MATERIALS ACCEPTANCE GUIDE				(Revised November 2020)		Same Frequency for all Tests (Minimums)										
MATERIAL AND OPERATION	DESCRIPTION OF TEST	TEST METHOD			FORM 734-	QUALITY ASSURANCE										
		ODOT	WAQTC	AASHTO		Contractor Quality Control	Project Manager	Region Quality Assurance	Materials Laboratory							
SECTION 00540 - STRUCTURAL CONCRETE (CONTINUED)																
Portland Cement Concrete	Sampling Air Content Slump Concrete Temperature Density (Unit Weight) Yield Water/Cement Ratio Strength	TM 2	T 152 T 119 T 309 T 121 T 121 T 121	3573WS or 4000C	4000C			QA Testing								
<p><i>(S)</i> 1 Set Represents a minimum of 3 Cylinders</p> <p><i>(M)</i> Per Mix Design & Source</p>																
<p>TABLE 00540-1 Frequency of Quality Control Testing</p> <p><u>Minimum frequencies per Class of concrete based on daily production records.</u></p> <table border="1"> <thead> <tr> <th><u>Production</u></th> <th><u>Frequencies</u></th> </tr> </thead> <tbody> <tr> <td>0 to 100 yd³ on a single day</td> <td>1 Set each day</td> </tr> <tr> <td><u>Quantity Over 100 yd³</u> 100 to 600 yd³ on a single day</td> <td>1 Set per each 100 yd³ or portion thereof</td> </tr> <tr> <td>over 600 yd³ on a single day</td> <td>1 Set per each 200 yd³ or portion thereof after reaching 600 yd³</td> </tr> </tbody> </table>									<u>Production</u>	<u>Frequencies</u>	0 to 100 yd ³ on a single day	1 Set each day	<u>Quantity Over 100 yd³</u> 100 to 600 yd ³ on a single day	1 Set per each 100 yd ³ or portion thereof	over 600 yd ³ on a single day	1 Set per each 200 yd ³ or portion thereof after reaching 600 yd ³
<u>Production</u>	<u>Frequencies</u>															
0 to 100 yd ³ on a single day	1 Set each day															
<u>Quantity Over 100 yd³</u> 100 to 600 yd ³ on a single day	1 Set per each 100 yd ³ or portion thereof															
over 600 yd ³ on a single day	1 Set per each 200 yd ³ or portion thereof after reaching 600 yd ³															

FIELD TESTED MATERIALS ACCEPTANCE GUIDE				(Revised November 2020)			Same Frequency for all Tests (Minimums)		
MATERIAL AND OPERATION	DESCRIPTION OF TEST	TEST METHOD			FORM 734-	Contractor Quality Control	QUALITY ASSURANCE		
		ODOT	WAQTC	AASHTO			Project Manager	Region Quality Assurance	Materials Laboratory
SECTION 00556 - MULTI-LAYER POLYMER CONCRETE OVERLAY									
Aggregate Production									
	Moisture Content			T 255/265	1792	At time of mixing the polymer resin. See 00556.10-b			
Polymer Resin	Material must meet the requirements of section 00556.10								

FIELD TESTED MATERIALS ACCEPTANCE GUIDE				Same Frequency for all Tests (Minimums)			
MATERIAL AND OPERATION	DESCRIPTION OF TEST	TEST METHOD		FORM 734-734-	Contractor Quality Control	QUALITY ASSURANCE	
		ODOT	WAQTC			AASHTO	Project Manager
SECTION 00557 - PREMIXED POLYMER CONCRETE OVERLAYS							
Resin Primer							
Polyester Resin Binder Including (Initiator, Accelerators & Inhibitors)							
Material must meet the requirements of section 00557.10							
Material must meet the requirements of section 00557.12 (a-c)							
Aggregate Production							
Product Compliance (Submit 2- 50 lb. samples of blended aggregate (00557.02) during the trial overlay)	Bulk Specific Gravity & Absorption Moisture Content Fracture (Method 1)			T 84 & T 85 T 255/265 T 335	4000	1/Project or Source	Submit to Lab
⁽¹⁾ Maybe required during Production	Moisture Content			T 255/265	1792	⁽¹⁾ During the Trial Overlay Strip	
Surface Texture Sand (see section 00557.12(e))	Sieve Analysis			T 27/11	1792	1/Project or Source	
Premixed Polymer Concrete							
	Density			T 121	3573WS	^(B) 1/Batch	
	Modulus of Elasticity		TM 759		4000C	^(M) Minimum 1 set/batch	
^(M) 1 set Represents a minimum of 3 (4"x8") cylinders cast per 00557.44(e)						1 set per 10 batches placed or minimum 1 set/day	Submit to Lab
^(B) Batch is defined "Per Mixer or Portion placed".							See section 00557.44(e)

FIELD TESTED MATERIALS ACCEPTANCE GUIDE				(Revised November 2020)			Same Frequency for all Tests (Minimums)		
MATERIAL AND OPERATION	DESCRIPTION OF TEST	TEST METHOD			FORM 734-	QUALITY ASSURANCE			
		ODOT	WAQTC	AASHTO		Contractor Quality Control	Project Manager	Region Quality Assurance	Materials Laboratory
SECTION 00559 - STRUCTURAL CONCRETE OVERLAYS									
Aggregate Production									
⁽¹⁾ QAE may waive after 5 sublots/shifts	Sampling Reducing ^{(2)/(3)/(4)} Sieve Analysis	R 90 R 76 T 27/T 11 T 27/T 11 T 176			1792	1/ Sublot & Start of Production		1 per 10 Sublots	
					1792				
⁽²⁾ Perform a minimum of 3 tests, QL's required	⁽⁴⁾ Fineness Modulus ⁽⁴⁾ Sand Equivalent				1792	1/5 Sublots & Start of Production			
⁽³⁾ Coarse Aggregate (See Section 02690.20)	^{(1)/(3)} Elongated Pieces ^{(1)/(3)} Wood Particles	TM 229 TM 225			4000	See Section 4(A)	Submit to Central Lab		See Section 4(A)
					4000				
⁽⁴⁾ Fine Aggregate (See Section 02690.30)	Abrasion Degradation Soundness Lightweight Pieces Organics	T 96 T 104 T 113 T 21			1825 1825C 1825	Start of production and when changes in aggregate occurs			
Portland Cement Modifiers Admixtures	Materials must meet the requirements of Section 02001.10								
Mixing Water	Material must meet the requirements of Section 02020								

FIELD TESTED MATERIALS ACCEPTANCE GUIDE				(Revised November 2020)			Same Frequency for all Tests (Minimums)										
MATERIAL AND OPERATION	DESCRIPTION OF TEST	TEST METHOD			FORM 734-	QUALITY ASSURANCE											
		ODOT	WAQTC	AASHTO		Contractor Quality Control	Project Manager	Region Quality Assurance	Materials Laboratory								
SECTION 00559 - STRUCTURAL CONCRETE OVERLAYS (CONTINUED)																	
Portland Cement Concrete	Sampling Air Content Slump Concrete Temperature Density (Unit Weight) Yield W/C Ratio	TM 2	T 152 T 119 T 309 T 121 T 121 T 121	3573WS or 4000 C	A subplot equals 1 set of tests per 50 yd ³												
										Strength	T 22 & T 23	4000C	1 / Sublot or Minimum 1 per Shift	1 per 10 Sublots			
																(M) (S) 1 Set Cylinders per 50yd ³ Minimum 1 set/shift	1 Set per 500 yd ³
(M) Per Mix Design & Source																	
(S) 1 Set Represents a minimum of 3 Cylinders																	
SECTION 00590 - POLYMER MEMBRANE																	
Broadcast Aggregate	Moisture Content		T 255/265	1792	Test at time of packaging and shipment. See Section 00590.10-c												
										Moisture Content	T 255/265	1792	Field Test at time of Mixing Polymer Resin. See Section 00590.10-c				

FIELD TESTED MATERIALS ACCEPTANCE GUIDE				(Revised November 2020)		Same Frequency for all Tests (Minimums)														
MATERIAL AND OPERATION	DESCRIPTION OF TEST	TEST METHOD			FORM 734-	QUALITY ASSURANCE														
		ODOT	WAQTC	AASHTO		Contractor Quality Control	Project Manager	Region Quality Assurance	Materials Laboratory											
SECTION 00596A - MECHANICALLY STABILIZED EARTH RETAINING WALLS																				
Aggregate Production																				
Gravel Leveling Pads Backfill (See Section 02630.10)	Abrasion Degradation	TM 208	T 96	4000	See Section 4A	Submit to Lab	See Section 4A	See Section 4A	See Section 4A	See Section 4A										
											A Sublot equals 1,000 Tons Minimum 1/Project									
											1792	1/5 Sublots	1/5 Sublots	1/5 Sublots	1/5 Sublots	1/5 Sublots	1/5 Sublots	1/5 Sublots	1/5 Sublots	1/5 Sublots
⁽³⁾ Modular Block Core and Drainage Backfill (Product Compliance)	Soundness Abrasion Degradation Lightweight Pieces	TM 208	T 104 T 96 T 113	4000	See Section 4C & 02690	Submit To Lab	See Section 4C	See Section 4C	See Section 4C	See Section 4C										
											Testing Frequency for Product Compliance per Source 1/5,000 Tons Minimum 1/Project									
											4000	See Section 4C & 02690	Submit To Lab	See Section 4C	See Section 4C	See Section 4C	See Section 4C	See Section 4C	See Section 4C	See Section 4C
⁽³⁾ Modular Block Core and Drainage Backfill ⁽¹⁾ QAE may waive after 5 sublots/shifts ⁽²⁾ Perform a minimum of 3 tests, QL's required	Sampling Reducing ⁽²⁾ Sieve Analysis ⁽¹⁾ Wood Particles Fracture (Method 2) Elongated Pieces	TM 225 TM 229	R 90 R 76 T 27/T 11 T 335	1792	1/5 Sublot	1/5 Sublot	1/5 Sublot	1/5 Sublot	1/5 Sublot	1/5 Sublot										
											A Sublot equals 1,000 Tons									
											1792	1/5 Sublot	1/5 Sublot	1/5 Sublot	1/5 Sublot	1/5 Sublot	1/5 Sublot	1/5 Sublot	1/5 Sublot	1/5 Sublot
Pipe Drain Backfill (Product Compliance) (See Section 00430.11)	Abrasion Degradation Sieve Analysis	TM 208	T 96 T 27	4000	See Section 4C	Submit To Lab	See Section 4C	See Section 4C	See Section 4C	See Section 4C										
											Testing Frequency for Product Compliance per Source 1/5,000 Tons Minimum 1/Project									
											4000	See Section 4C	Submit To Lab	See Section 4C	See Section 4C	See Section 4C	See Section 4C	See Section 4C	See Section 4C	See Section 4C

FIELD TESTED MATERIALS ACCEPTANCE GUIDE				(Revised November 2020)			Same Frequency for all Tests (Minimums)			
MATERIAL AND OPERATION	DESCRIPTION OF TEST	TEST METHOD			FORM 734-	Contractor Quality Control	QUALITY ASSURANCE			
		ODOT	WAQTC	AASHTO			Project Manager	Region Quality Assurance	Materials Laboratory	
SECTION 00596A - MECHANICALLY STABILIZED EARTH RETAINING WALLS										
Aggregate Production										
Gabion Basket Fill (Product Compliance) (See Section 00390.11(b))	Degradation Soundness Apparent Specific Gravity & Absorption Gradation	TM 208		T 104 T 85	4000 1825	See Section 4C	Submit to Lab	Visual	Testing Frequency for Product Compliance per Source 1/5,000 Tons Minimum 1/Project	See Section 4C

FIELD TESTED MATERIALS ACCEPTANCE GUIDE				Same Frequency for all Tests (Minimums)			
MATERIAL AND OPERATION	DESCRIPTION OF TEST	TEST METHOD		FORM 734-1792	QUALITY ASSURANCE		
		ODOT	WAQTC		AASHTO	Contractor Quality Control	Independent Assurance/Verification
SECTION 00596A - MSE RETAINING WALLS							
Aggregate Production							
MSE Granular Wall Backfill (Product Compliance) (Also reference 02630.10)	Abrasion Degradation Sieve Analysis Plasticity Index pH Resistivity Organic Content	TM 208		T96 T 11 T 90 T 289 T 288 T 267	4000	See Section 4C	See Section 4C
Testing Frequency for Product Compliance per Source 1/5,000 Tons Minimum 1/Project							
A Sublot Equals 2,000 Tons							
MSE Granular Wall Backfill (¹) Perform a minimum of 3 tests, QL's required	Sampling Reducing (¹) Sieve Analysis Sand Equivalent Fracture (Method 1)			R 90 R 76 T 27 T 176 T 335	1792	1/Sublot	
Placement Establishing Maximum Density (¹) Method A	Density Curve			(¹) T 99	3468	1/Aggregate Gradation/Per Source	
	Bulk Specific Gravity			T 85	3468		
Compaction	Coarse Particle Correction	TM 223			1793B	1/ 100 yd3 (Minimum 1/day)	
	Nuclear Gauge			T 310	1793B	1 per layer	Visual See section 00596A.47 (c-5)
	Deflection Testing	TM 158					
<p>Contractor must demonstrate, by compaction testing or acceptable visual means, that the material, equipment, and process used for compaction achieves the specification requirements. If the material, equipment, or process changes, or if other conditions indicate a non-specification product, the Contractor must re-demonstrate that specification requirements are being achieved.</p>							

FIELD TESTED MATERIALS ACCEPTANCE GUIDE				(Revised November 2020)			Same Frequency for all Tests (Minimums)				
MATERIAL AND OPERATION	DESCRIPTION OF TEST	TEST METHOD			FORM 734-	QUALITY ASSURANCE					
		ODOT	WAQTC	AASHTO		Contractor Quality Control	Project Manager	Region Quality Assurance	Materials Laboratory		
SECTION 00596B - PREFABRICATED MODULAR RETAINING WALLS											
Aggregate Production											
Gravel Leveling Pads Backfill (See Section 02630.10)	Abrasion Degradation	TM 208		T96	4000	See Section 4A	Submit to Lab			See Section 4A	
	Sampling Reducing Sieve Analysis Sand Equivalent			R 90 R 76 T 27 T 176		1/Sublot					
					T 335	1792	1/5 Sublots				
		Fracture (Method 1)									
						Testing Frequency for Product Compliance per Source 1/5,000 Tons Minimum 1/Project					
⁽³⁾ Modular Block Core and Drainage Backfill (Product Compliance)	Soundness			T 104 T 96	4000	See Section 4C & 02690	Submit To Lab			See Section 4C	
	Abrasion Degradation	TM 208			4000						
	Lightweight Pieces			T 113							
⁽³⁾ (See Section 2690.20(a) thru 2690.20(d) & 2690.20(f))											
⁽³⁾ Modular Block Core and Drainage Drainage Backfill	Sampling Reducing			R 90 R 76 T 27/T 11	1792	1/Sublot					
	⁽²⁾ Sieve Analysis										
	⁽¹⁾ Wood Particles Fracture (Method 2) Elongated Pieces	TM 225 TM 229		T 335	1792						
⁽²⁾ Perform a minimum of 3 tests, QL's required											
Pipe Drain Backfill (Product Compliance) (See Section 00430.11)	Abrasion Degradation	TM 208		T 96	4000	See Section 4C	Submit To Lab			See Section 4C	
	Sieve Analysis										
					T 27	4000	1/Sublot				
A Sublot equals 1,000 Tons											

FIELD TESTED MATERIALS ACCEPTANCE GUIDE				(Revised November 2020)				Same Frequency for all Tests (Minimums)				
MATERIAL AND OPERATION	DESCRIPTION OF TEST	TEST METHOD			FORM 734-	QUALITY ASSURANCE						
		ODOT	WAQTC	AASHTO		Contractor Quality Control	Project Manager	Region Quality Assurance	Materials Laboratory			
SECTION 00596B - PREFABRICATED MODULAR RETAINING WALLS												
Aggregate Production												
Gabion Basket Fill (Product Compliance) (See Section 00390.11(b))	Degradation Soundness Apparent Specific Gravity & Absorption Gradation	TM 208		T 104 T 85	4000 1825	See Section 4C	Submit to Lab	Visual	See Section 4C	Testing Frequency for Product Compliance per Source 1/5,000 Tons Minimum 1/Project		

FIELD TESTED MATERIALS ACCEPTANCE GUIDE				(Revised November 2020)		Same Frequency for all Tests (Minimums)		
MATERIAL AND OPERATION	DESCRIPTION OF TEST	TEST METHOD		FORM 734-	Contractor Quality Control	QUALITY ASSURANCE		Materials Laboratory
		ODOT	WAQTC			AASHTO	Project Manager	
SECTION 00596B - PREFABRICATED MODULAR RETAINING WALLS								
Aggregate Production								
Retaining Wall Granular Backfill (Product Compliance) (Also reference 02630.10)	Abrasion Degradation Sieve Analysis Plasticity Index	TM 208		T 96 T 11 T 90	4000 4000	See Section 4C	Submit to Central Lab	See Section 4C
A Sublot Equals 2,000 Tons								
Retaining Wall Granular Backfill (¹) Perform a minimum of 3 tests, QL's required	Sampling Reducing (¹) Sieve Analysis Sand Equivalent			R 90 R 76 T 27 T 176	1792	1/Sublot		
Establishing Maximum Density (¹) Method A	Density Curve			(1) T 99	3468	1/Aggregate Gradation/Per Source		
Compaction	Coarse Particle Correction	TM 223		T 310	1793B	1/ 100 yd3 (Minimum 1/day)		
	Deflection Testing							

FIELD TESTED MATERIALS ACCEPTANCE GUIDE				(Revised November 2020)			Same Frequency for all Tests (Minimums)										
MATERIAL AND OPERATION	DESCRIPTION OF TEST	TEST METHOD			FORM 734-	QUALITY ASSURANCE			Materials Laboratory								
		ODOT	WAQTC	AASHTO		Contractor Quality Control	Project Manager	Region Quality Assurance									
SECTION 00596C - CAST-IN-PLACE CONCRETE RETAINING WALLS																	
Aggregate Production																	
Pipe Drain Backfill (Product Compliance) (See Section 00430.11)	Abrasion Degradation	TM 208	T 96	4000	See Section 4C	Submit To Lab			See Section 4C								
											Sampling Reducing Sieve Analysis	R 90 R 76 T 27	4000	1/Sublot			
Testing Frequency for Product Compliance per Source 1/5,000 Tons Minimum 1/Project																	
Retaining Wall Granular Backfill	Abrasion Degradation Sieve Analysis Plasticity Index	TM 208	T 96 T 11 T 90	4000	See Section 4C	Submit to Central Lab			See Section 4C								
Retaining Wall Granular Backfill (Product Compliance) (Also reference 02630.10)											4000						
Retaining Wall Granular Backfill (¹) Perform a minimum of 3 tests, QL's required																	A Sublot Equals 2,000 Tons

FIELD TESTED MATERIALS ACCEPTANCE GUIDE				(Revised November 2020)			Same Frequency for all Tests (Minimums)		
MATERIAL AND OPERATION	DESCRIPTION OF TEST	TEST METHOD			FORM 734-	Contractor Quality Control	QUALITY ASSURANCE		
		ODOT	WAQTC	AASHTO			Project Manager	Region Quality Assurance	Materials Laboratory
SECTION 00596C - CAST-IN-PLACE CONCRETE RETAINING WALLS									
Placement									
Retaining Wall Granular Backfill	Density Curve			(1) T 99	3468				
Establishing Maximum Density	Bulk Specific Gravity			T 85	3468	1/Aggregate Gradation/Per Source			
Compaction	Coarse Particle Correction	TM 223		T 310	1793B	1/ 100 yd3 (Minimum 1/day)			
	Nuclear Gauge				1793B	1 per layer			
	Deflection Testing	TM 158					Visual See section 00596C.42(f)		
<p>Contractor must demonstrate, by compaction testing or acceptable visual means, that the material, equipment, and process used for compaction achieves the specification requirements. If the material, equipment, or process changes, or if other conditions indicate a non-specification product, the Contractor must re-demonstrate that specification requirements are being achieved.</p>									

FIELD TESTED MATERIALS ACCEPTANCE GUIDE				(Revised November 2020)				Same Frequency for all Tests (Minimums)			
MATERIAL AND OPERATION	DESCRIPTION OF TEST	TEST METHOD			FORM 734-	QUALITY ASSURANCE					
		ODOT	WAQTC	AASHTO		Contractor Quality Control	Project Manager	Region Quality Assurance	Materials Laboratory		
SECTION 00635 - GRID-ROLLED AGGREGATE SUBBASE											
Aggregate Subbase Grading (See 00635.10)	Abrasion			T 96	4000	1/Source		A Sublot equals 1000 Tons		See Section 4(A)	
							Submit To Central Lab				
	Sampling Reducing Sieve Analysis Sand Equivalent			R 90 R 76 T 27 T 176	1792	1/Sublot & Start of Production					

FIELD TESTED MATERIALS ACCEPTANCE GUIDE				Same Frequency for all Tests (Minimums)				
MATERIAL AND OPERATION	DESCRIPTION OF TEST	TEST METHOD		FORM 734-	QUALITY ASSURANCE			
		ODOT	WAQTC		AASHTO	Contractor Quality Control	Project Manager	Region Quality Assurance
SECTION 00641 - AGGREGATE SUBBASE, BASE, AND SHOULDERS								
Aggregate Production Aggregate Subbase Grading (See 00641.10(b))	Abrasion			T 96	4000	See Sec. 4A	Submit To Central Lab	See Section 4(A)
	Sampling Reducing Sieve Analysis Sand Equivalent			R 90 R 76 T 27 T 176		1/Project or 1/Source	Visual	
	Abrasion Degradation	TM 208		T96	4000	See Section 4A	Submit to Lab	See Section 4A
	Grading Aggregate Base (See 02630) Aggregate Shoulder (See 02640) Open Graded Aggregate Base (See 02630.11) ⁽¹⁾ Perform at least 3 tests ⁽²⁾ May be waived by QAE			R 90 R 76 T 27 T 176 T 335		1/Sublot & Start of Production 1/5 Sublots & Start of Production		1 per 10 Sublots
Placement								
Aggregate Base Plant Mix Applications Only Aggregate (Mixture)	Sampling Reducing Moisture			R 90 R 76 T 255 & T 265		1/Sublot or minimum 1/Day		1 per 10 Sublots
	Density Curve Coarse Particle Correction Bulk Specific Gravity	TM 223		⁽³⁾ T 99 T 85	3468 B 3468 B	Each Size per Source		1/Project
	Deflection Testing Nuclear Gauge	TM 158		T310	1793B 1793B	1 per Sublot ^(D) 5 Tests Per Sublot		^(D) 1 (5 Tests) per 10 Sublots
	Compaction ^(D) (Individual tests must meet Specification)							

FIELD TESTED MATERIALS ACCEPTANCE GUIDE					(Revised November 2020)			Same Frequency for all Tests (Minimums)		
MATERIAL AND OPERATION	DESCRIPTION OF TEST	TEST METHOD			FORM 734-	Contractor Quality Control	QUALITY ASSURANCE			
		ODOT	WAQTC	AASHTO			Project Manager	Region Quality Assurance	Materials Laboratory	
SECTION 00641 - AGGREGATE SUBBASE, BASE, AND SHOULDERS (Continued)										
Placement										
Aggregate Subbase										
Compaction	Deflection Testing	TM 158			1793 B	1 per Layer	Visual			

FIELD TESTED MATERIALS ACCEPTANCE GUIDE				(Revised November 2020)		Same Frequency for all Tests (Minimums)								
MATERIAL AND OPERATION	DESCRIPTION OF TEST	TEST METHOD			FORM 734-734-	QUALITY ASSURANCE								
		ODOT	WAQTC	AASHTO		Contractor Quality Control	Project Manager	Region Quality Assurance	Materials Laboratory					
SECTION 00680 - STOCKPILED AGGREGATES														
Aggregate Base and Shoulders (See Section 00641)	Abrasion Degradation	TM 208		T 96	4000	See Section 4A	Submit to Lab			See Section 4A				
					A Sublot equals 2,000 Tons									
					1792	1/Sublot & Start of Production								
					1792							1 per 10 Sublots		
					1792	1/5 Sublots & Start of Production								
(1) Perform at least 3 tests, QL's required (2) May be waived by QAE	Fracture (Method 1)			T 335	1792									
					A Sublot equals 1000 Tons									
					1792	1/Sublot & Start of Production								
					1792							1 per 10 Sublots		
					1792									
Aggregate (Sanding Aggregate)	Sampling Reducing Sieve Analysis (1) Cleaness Value	TM 227		R 90 R 76 T 27	1792	1/Sublot & Start of Production								
					A Sublot equals 1000 Tons									
					4000	See Section 4A	Submit to Lab							
					4000							1 per 10 Sublots		
					1792	1/5 Sublots & Start of Production								
(1) May be waived by QAE	Abrasion Degradation Lightweight Pieces Fracture (Method 1) Elongated Pieces Wood Particles	TM 208 TM 229 TM 225		T 96 T 113 T 335	4000	See Section 4A	Submit to Lab							
					A Sublot equals 1000 Tons									
					4000									
					1792	1/5 Sublots & Start of Production						1 per 10 Sublots		
					1792									

FIELD TESTED MATERIALS ACCEPTANCE GUIDE				Same Frequency for all Tests (Minimums)												
MATERIAL AND OPERATION	DESCRIPTION OF TEST	TEST METHOD			FORM 734-	QUALITY ASSURANCE										
		ODOT	WAQTC	AASHTO		Contractor Quality Control	Project Manager	Region Quality Assurance	Materials Laboratory							
SECTION 00680 - STOCKPILED AGGREGATES (CONTINUED)																
Emulsified AC Aggregate Aggregate Production (See Sections 00705, 00706, 00710, 00711, 00712 and 00715) (1) QAE may waive after 5 sublots/shifts (2) Perform at least 3 tests (QL's required), QAE may waive wet sieve after 5 sublots/shifts if a correlation to dry sieve can be demonstrated (3) May be waived by QAE (4) Not required for Dry Key Material (5) 1/5 Sublots & Start of Production	Abrasion Degradation Soundness Lightweight Pieces Dry Rodded Unit Weight Sampling Reducing (5) Fracture (Method 1) (1) Wood Particles (1)(4) Elongated Pieces (2) Sieve Analysis (3) Cleaness Value Dry Rodded Unit Weight	TM 208 TM 225 TM 229 TM 227	T 96 T 104 T 113 T 19 R 90 R 76 T 335 T27/T 11 T 19	4000 4000 1792 1792 1825 1825C	A sublot equals 500 Tons. A minimum 1 per shift, whichever results in the greatest sampling frequency See Section 4A Submit to Lab 1/Sublot & Start of Production Start of production and when changes in aggregate occurs	See Section 4A 1 per 10 Sublots	See Section 4A									
								Aggregate (Other)								
								Use sampling and testing frequencies required for proposed end product use								

FIELD TESTED MATERIALS ACCEPTANCE GUIDE				(Revised November 2020)				Same Frequency for all Tests (Minimums)			
MATERIAL AND OPERATION	DESCRIPTION OF TEST	TEST METHOD			FORM 734-	QUALITY ASSURANCE					
		ODOT	WAQTC	AASHTO		Contractor Quality Control	Project Manager	Region Quality Assurance	Materials Laboratory		
SECTION 00705 - EMULSIFIED ASPHALT PRIME COAT and EMULSIFIED ASPHALT FOG COAT											
Aggregate Production											
Aggregate Cover Material	Reducing Sieve Analysis			R 90 R 76 T 27	1792	1/Sublot & Start of Production	1 per 10 Sublots				
Asphalt Prime and Fog Coat Asphalt Cement (Emulsion)	Compliance			R 66	4000	See Section 4C 1/50 Tons (Submit All)	Submit to Central Lab				1/5 QC Samples (Random)
SECTION 00706 - EMULSIFIED ASPHALT SLURRY SEAL SURFACING											
Aggregate Production											
⁽¹⁾ Perform at least 3 tests, QL's required	Sampling Reducing			R 90 R 76 T 27/T 11	1792	1/Sublot & Start of Production					
	⁽¹⁾ Sieve Analysis										
Emulsified Asphalt Cement Emulsified Asphalt Polymer Modified Emulsion	Compliance				4000	See Section 4C 1/50 Tons (Submit All)	Submit to Central Lab				1/5 QC Samples (Random)
Additives Mineral Filler											
Material must meet the requirements of Section 00706.13											
Mixture											
Material must meet the requirements of Section 00706.16											

FIELD TESTED MATERIALS ACCEPTANCE GUIDE				Same Frequency for all Tests (Minimums)				
MATERIAL AND OPERATION	DESCRIPTION OF TEST	TEST METHOD		FORM 734-	QUALITY ASSURANCE			
		ODOT	WAQTC		AASHTO	Contractor Quality Control	Project Manager	Region Quality Assurance
SECTION 00710 - SINGLE APPLICATION EMULSIFIED ASPHALT SURFACE TREATMENT								
Aggregate Production								
<p>(1) QAE may waive after 5 sublots/shifts</p> <p>(2) Perform at least 3 tests (QL's required), QAE may waive wet sieve after 5 sublots/shifts if a correlation to dry sieve can be demonstrated</p> <p>(3) May be waived by QAE</p> <p>(4) Not required for Dry Key Material</p> <p>(5) 1/5 Sublots & Start of Production</p> <p>Asphalt Cement (Emulsion)</p>	Abrasion	TM 208	T 96	4000	See Section 4A	Submit to Central Lab	1 per 10 Sublots	See Section 4A
	Degradation		T 104					
	Soundness		T 113					
	Lightweight Pieces		T 19	4000				
	Dry Rodded Unit Weight		R 90					
	Sampling		R 76					
	Reducing		T 335	1792				
	(5) Fracture (Method 1)							
	(1) Wood Particles	TM 225	T27/T 11	1792				
	(1)(4) Elongated Pieces	TM 229						
(2) Sieve Analysis	TM 227							
(3) Cleaness Value								
Dry Rodded Unit Weight		T 19	1825	Start of production and when changes in aggregate occurs				
Compliance		R 66	1825C					
			4000	1/50 Tons Submit All	Submit to Lab			1/5 QC Samples (Random)
Preproduced Aggregate								
Compliance of aggregates produced and stockpiled before the award date or notice to proceed of this contract will be determined by the following:								
1. Continuing production records meeting the above requirements of Section 00710.10 and 710.15, Aggregate Production.								
2. Furnish records of testing for the entire stockpile according to Section 00710.10 and 710.15 Aggregate Production except change the sampling frequency to the following:								
a. One Per 5 sublots means "One Set of Tests Per 2500 Tons".								
b. One Per sublot means "One Set of Tests Per 500 Tons" with a minimum of 3 sets of Sieve Analysis tests per project.								
c. Provide one stockpile sample for each set of tests required above.								

FIELD TESTED MATERIALS ACCEPTANCE GUIDE				Same Frequency for all Tests (Minimums)												
MATERIAL AND OPERATION	DESCRIPTION OF TEST	TEST METHOD		FORM 734-	QUALITY ASSURANCE											
		ODOT	WAQTC		AASHTO	Contractor Quality Control	Project Manager	Region Quality Assurance	Materials Laboratory							
SECTION 00711 - PRE-COATED AGGREGATE ASPHALT SURFACE TREATMENT																
Aggregate Production																
(1) QAE may waive after 5 sublots/shifts (2) Perform at least 3 tests (QL's required), QAE may waive wet sieve after 5 sublots/shifts if a correlation to dry sieve can be demonstrated (3) May be waived by QAE (4) Not required for Dry Key Material (5) 1/5 Sublots & Start of Production	Abrasion Degradation Soundness Lightweight Pieces Dry Rodded Unit Weight Sampling Reducing (5) Fracture (Method 1) (1) Wood Particles (1)(4) Elongated Pieces (2) Sieve Analysis (3) Cleaness Value Dry Rodded Unit Weight	TM 208 TM 225 TM 229 TM 227	T 96 T 104 T 113 T 19 R 90 R 76 T 335 T27/T 11 T 19	4000 4000 1792 1792 1825 1825C 4000	A sublot equals 500 Tons. A minimum 1 per shift whichever results in the greatest sampling frequency	See Section 4A 1/Sublot & Start of Production Start of production and when changes in aggregate occurs 1/50 Tons Submit All	Submit to Central Lab 1 per 10 Sublots Submit to Lab	See Section 4A 1/5 QC Samples (Random)								
									Asphalt Cement							
									Preproduced Aggregate							
									Compliance of aggregates produced and stockpiled before the award date or notice to proceed of this contract will be determined by the following:							
									1. Continuing production records meeting the above requirements of Section 00711.10 and 711.15, Aggregate Production.							
									2. Furnish records of testing for the entire stockpile according to Section 00711.10 and 711.15 Aggregate Production except change the sampling frequency to the following:							
									a. One Per 5 sublots means "One Set of Tests Per 2500 Tons".							
									b. One Per sublot means "One Set of Tests Per 500 Tons" with a minimum of 3 sets of Sieve Analysis tests per project.							
									c. Provide one stockpile sample for each set of tests required above.							

FIELD TESTED MATERIALS ACCEPTANCE GUIDE				Same Frequency for all Tests (Minimums)			
MATERIAL AND OPERATION	DESCRIPTION OF TEST	TEST METHOD		FORM 734-	QUALITY ASSURANCE		
		ODOT	WAQTC		AASHTO	Contractor Quality Control	Project Manager
SECTION 00711 - PRE-COATED AGGREGATE ASPHALT SURFACE TREATMENT (CONTINUED)							
Mixture Acceptance							A sublot equals 500 Tons. A minimum 1 per shift, whichever results in the greatest sampling frequency
Meter Method	Readings backed by Tank Measure & Production Records Daily	TM 321 (1) TM 322			2277	1/Sublot or Min. 1/Day	
(1) Required at start of production and if meters fail to meet specification	Cold Feed Moisture		T 255/265		2043 & 2401	Daily Production	
Plant Discharge Moisture	Asphalt Mix Moist.		T 329		2277	1/Sublot or Min. 1/Day	
Asphalt Cement	Compliance		R 66		4000	1/50 Tons Submit All	1/5 QC Samples (Random)
						Submit to Lab	

FIELD TESTED MATERIALS ACCEPTANCE GUIDE				Same Frequency for all Tests (Minimums)									
MATERIAL AND OPERATION	DESCRIPTION OF TEST	TEST METHOD		FORM 734-	QUALITY ASSURANCE								
		ODOT	WAQTC		AASHTO	Contractor Quality Control	Project Manager	Region Quality Assurance	Materials Laboratory				
SECTION 00712 - DRY KEY EMULSIFIED ASPHALT SURFACE TREATMENT													
Aggregate Production													
Abrasion Degradation Soundness Lightweight Pieces Dry Rodded Unit Weight Sampling Reducing ⁽⁵⁾ Fracture (Method 1) ⁽¹⁾ Wood Particles ⁽¹⁾⁽⁴⁾ Elongated Pieces ⁽²⁾ Sieve Analysis ⁽³⁾ Cleaness Value Dry Rodded Unit Weight Compliance	TM 208 TM 225 TM 229 TM 227	T 96 T 104 T 113 T 19 R 90 R 76 T 335 T 27/T 11 T 19 R 66	4000 4000 1792 1792 1825 1825C 4000	A sublot equals 500 Tons. A minimum 1 per shift, whichever results in the greatest sampling frequency				See Section 4A Submit to Central Lab 1/Sublot & Start of Production Start of production and when changes in aggregate occurs Submit to Lab	See Section 4A 1/5 QC Samples (Random)				
				Preproduced Aggregate									
				Compliance of aggregates produced and stockpiled before the award date or notice to proceed of this contract will be determined by the following:									
				1. Continuing production records meeting the above requirements of Section 00712.10 and 712.15, Aggregate Production.									
				2. Furnish records of testing for the entire stockpile according to Section 00712.10 and 712.15 Aggregate Production except change the sampling frequency to the following:									
				a. One Per 5 sublots means "One Set of Tests Per 2500 Tons".									
				b. One Per sublot means "One Set of Tests Per 500 Tons" with a minimum of 3 sets of Sieve Analysis tests per project.									
				c. Provide one stockpile sample for each set of tests required above.									

FIELD TESTED MATERIALS ACCEPTANCE GUIDE				(Revised November 2020)			Same Frequency for all Tests (Minimums)			
MATERIAL AND OPERATION	DESCRIPTION OF TEST	TEST METHOD			FORM 734-	QUALITY ASSURANCE				
		ODOT	WAQTC	AASHTO		Contractor Quality Control	Project Manager	Region Quality Assurance	Independent Assurance/Verification	Materials Laboratory
SECTION 00720 - COLD IN-PLACE RECYCLED ASPHALT CONCRETE PAVEMENT (CIR)										
SECTION 00721 - COLD RECYCLED EMULSIFIED ASPHALT CONCRETE PAVEMENT (CRP)										
Asphalt Cement (Emulsified Recycling Agent)	Compliance			R 66	4000	See Section 4C 1/50 Tons (Submit All)	Submit to Central Lab			1/5 QC Samples (Random)
Water	Compliance				4000	See Sec.00340.10				
Aggregate Production Choke Aggregate (See 00705)	Sampling Reducing Sieve Analysis			R 90 R 76 T 27	1792	1/Sublot & Start of Production		Minimum 1/Project		
SECTION 00725 - HOT IN-PLACE RECYCLED (HIR) ASPHALT CONCRETE PAVEMENT										
<i>The type of recycling agent will be listed in the Special Provisions</i>										
Recycling Agent (See 00745.11)	Compliance			R 66	4000	See Section 4C	Submit to Lab			1/5 QC Samples (Random)
Recycling Agent	Compliance			R 66	4000	1/50 Tons	Submit to Lab			
Asphalt Concrete Mixture	New Asphalt Concrete mixture will meet the requirements of Section 00744									
SECTION 00730 - ASPHALT TACK COAT										
Tack	Compliance			R 66	4000	See Section 4C 1/50 Tons	Submit to Lab			1/50 Tons or All QC Samples

FIELD TESTED MATERIALS ACCEPTANCE GUIDE				(Revised November 2020)		Same Frequency for all Tests (Minimums)					
MATERIAL AND OPERATION	DESCRIPTION OF TEST	TEST METHOD			FORM 734-	QUALITY ASSURANCE					
		ODOT	WAQTC	AASHTO		Contractor Quality Control	Project Manager	Region Quality Assurance	Materials Laboratory		
SECTION 00735 - EMULSIFIED ASPHALT CONCRETE PAVEMENT											
Aggregate production											
⁽¹⁾ Perform at least 3 tests, QL's required ⁽²⁾ May be waived by QAE ⁽³⁾ QAE may waive after 5 sublots/shifts	Abrasion Degradation Soundness Lightweight Pieces	TM 208		T 96 T 104 T 113	4000 4000	See Section 4A	Submit to Lab			See Section 4A	
		A Sublot equals 1000 Tons. A minimum one per shift, whichever results in the greatest sampling frequency. (For preproduced aggregates, 1 shift shall mean 1000 Tons)									
Choke Aggregate	Sampling Reducing ⁽¹⁾ Sieve Analysis ⁽²⁾ Cleanness Value Fracture (Method 1 & 2) ⁽³⁾ Elongated Pieces ⁽³⁾ Wood Particles Sieve Analysis			R 90 R 76 T 27/T 11 T 335	1792 1792	1/Sublot & Start of Production		1 per 10 Sublots			
				T 27	1792	1/Sublot		1/Project			

FIELD TESTED MATERIALS ACCEPTANCE GUIDE				Same Frequency for all Tests (Minimums)								
MATERIAL AND OPERATION	DESCRIPTION OF TEST	TEST METHOD			FORM 734-	QUALITY ASSURANCE						
		ODOT	WAQTC	AASHTO		Contractor Quality Control	Project Manager	Region Quality Assurance	Materials Laboratory			
SECTION 00743 - POROUS ASPHALT CONCRETE (PAC)												
Aggregate Production												
(1) QAE may waive after 5 sublots/shifts	Soundness Abrasion Degradation Lightweight Pieces Plasticity Index	TM 208			4000			See Section 4A	Submit to Lab		See Section 4A	
												T 104 T 96
												T 113 T 90
(2) Not required for ATPB Mix	Sampling Reducing (3)(4) Sieve Analysis (1)(4) Sand Equivalent				1792			1/Sublot & Start of Production			A Sublot equals 1000 Tons. A minimum one per shift whichever results in the greatest sampling frequency	
(3) Coarse Agg (+ No. 4)												
(4) Fine Agg (- No. 4)												
	(1)(2)(3) Elongated Pieces (3)(4) Fracture (Method 2) (1)(2)(3) Wood Particles	TM 229 TM 225			1792			1/5 Sublots & Start of Production				
												T 335
Preproduced Aggregate												
Compliance of aggregates produced and stockpiled before the award date or notice to proceed of this contract will be determined by the following:												
1. Continuing production records meeting the above requirements of Section 00743.10 Aggregate Production.												
2. Furnish records of testing for the entire stockpile according to Section 00743.10 Aggregate Production except change the sampling frequency to the following:												
a. One Per 5 sublots means "One Set of Tests Per 5000 Tons".												
b. One Per sublot means "One Set of Tests Per 1000 Tons" with a minimum of 3 sets of Sieve Analysis tests per project.												
c. Provide one stockpile sample for each set of tests required above.												

FIELD TESTED MATERIALS ACCEPTANCE GUIDE				(Revised November 2020)		Same Frequency for all Tests (Minimums)				
MATERIAL AND OPERATION	DESCRIPTION OF TEST	TEST METHOD			FORM 734-	QUALITY ASSURANCE				
		ODOT	WAQTC	AASHTO		Contractor Quality Control	Project Manager	Region Quality Assurance	Materials Laboratory	
SECTION 00743 - POROUS ASPHALT CONCRETE (PAC) (CONTINUED)										
Mixture Acceptance - PAC with RAP										
A Sublot equals 1000 Tons										
Ignition method	(1) Calibrate Incinerator	TM 323			2327IC	1/JMF & Each Calendar Year.				
Ignition method	Sampling Reducing			R 97 R 47		1/Sublot or Min. 1/Day				
(Residual aggregate from AASHTO T 308)	Sieve analysis			T 30	2277	1/Sublot or Min. 1/day				
(1) Submit Samples a minimum of 2 Days Prior to ACP Production										
A Sublot equals 1000 Tons										
Asphalt Content										
Ignition Method	(1) Calibrate Incinerator	TM 323			2327IC	1/JMF & Each Calendar Year.				
Ignition Method	Sampling Reducing			R 97 R 47		1/Sublot or Min. 1/day				
Meter Method	Asphalt Content			T 308	2277					
	Readings backed by Tank measure & Production Records Daily	TM 321 (2) TM 322			2277	1/Sublot or Min. 1/day				
(2) Required at start of production and if meters fail to meet specification					2043 & 2401	Daily Production				
<u>Meter Method is required for PAC even when acceptance is by Ignition Method</u>										

FIELD TESTED MATERIALS ACCEPTANCE GUIDE				(Revised November 2020)			Same Frequency for all Tests (Minimums)			
MATERIAL AND OPERATION	DESCRIPTION OF TEST	TEST METHOD			FORM 734-	QUALITY ASSURANCE				
		ODOT	WAQTC	AASHTO		Contractor Quality Control	Project Manager	Region Quality Assurance	Materials Laboratory	
SECTION 00743 - POROUS ASPHALT CONCRETE (PAC) (CONTINUED)										
Mixture Acceptance - PAC without RAP										
Gradation Cold Feed Method	Sampling Reducing Sieve Analysis	TM 323			R 90 R 76 T 27/T 11	2277	A Sublot equals 1000 Tons			
							1/Sublot or Min. 1/Day			
Ignition method	(1) Calibrate Incinerator	TM 323			2327IC		1/JMF & Each Calendar Year.			
Ignition method	Sampling Reducing				R 97 R 47		1/Sublot or Min. 1/Day			
(1) Not required if Asphalt Content Accepted by Meter Method (Residual aggregate from AASHTO T 308)	Sieve analysis				T 30	2277	1/Sublot or Min. 1/day			
(1) Submit Samples a minimum of 2 Days Prior to ACP Production										
Asphalt Content										
Ignition Method	(1) Calibrate Incinerator	TM 323				2327IC	1/JMF & Each Calendar Year.			
Ignition Method	Sampling Reducing				R 97 R 47		1/Sublot or Min. 1/day			
(2) Required at start of production and if meters fail to meet specification	Asphalt Content				T 308	2277				
Meter Method	Readings backed by Tank measure & Production Records Daily	TM 321 (2) TM 322				2277	1/Sublot or Min. 1/day			
Meter Method is required for PAC even when acceptance is by Ignition Method						2043 and 2401	Daily Production			

FIELD TESTED MATERIALS ACCEPTANCE GUIDE				Same Frequency for all Tests (Minimums)			
MATERIAL AND OPERATION	DESCRIPTION OF TEST	TEST METHOD		FORM 734-	QUALITY ASSURANCE		
		ODOT	WAQTC		AASHTO	Contractor Quality Control	Project Manager
SECTION 00743 - POROUS ASPHALT CONCRETE (PAC) (CONTINUED)							
Mixture Acceptance - PAC with and without RAP							
Mix Design Verification Testing							
	Cold Feed Moisture			T255/T265	2277	1/Sublot or Min. 1/Day	
Plant Discharge Moisture	Asphalt Mix Moist.			T 329	2277	1/Sublot or Min. 1/Day	
⁽¹⁾ RAP Percentage	⁽¹⁾ RAP Moisture			T 329	2277	1/Sublot or Min. 1/Day	
⁽¹⁾ If applicable	Readings backed by Tank measure & Production Records Daily	TM321 ⁽²⁾ TM 322			2401 & 2043	Daily Production	
Asphalt Cement	Compliance			R 66	4000	1/Sublot - See section 4C	1/5 QC Samples (Random)
⁽²⁾ Required at start of production and if meters fail to meet specification						Submit to Lab	

FIELD TESTED MATERIALS ACCEPTANCE GUIDE				Same Frequency for all Tests (Minimums)				
MATERIAL AND OPERATION	DESCRIPTION OF TEST	TEST METHOD			FORM 734-	QUALITY ASSURANCE		
		ODOT	WAQTC	AASHTO		Contractor Quality Control	Project Manager	Region Quality Assurance
SECTION 00744 - ASPHALT CONCRETE PAVEMENT								
Aggregate Production								
See Specifications when Aggregate Testing is Required by the Agency								
A Sublot equals 1000 Tons								
Mixture Acceptance								
Gradation								
Ignition method	(1) Calibrate Incinerator	TM 323			2327IC	1/JMF & Each Calendar Year.		
Ignition method	Sampling Reducing			R 97 R 47		1/Sublot or Min. 1/Day		
(Residual aggregate from AASHTO T 308)	Sieve analysis			T 30	2277	1/Sublot or Min. 1/Day		
(1) Submit Samples a minimum of 2 Days Prior to ACP Production								
A Sublot equals 1000 Tons								
Asphalt Content								
Ignition Method	(1) Calibrate Incinerator	TM 323			2327IC	1/JMF & Each Calendar Year.		
Ignition Method	Sampling Reducing			R 97 R 47		1/Sublot or Min. 1/day		
	Asphalt Content			T 308	2277			
A Sublot equals 1000 Tons								
Mix Design Verification Testing								
Plant Discharge Moisture	Asphalt Mix Moist.			T 329	2277	1/Sublot		
Maximum Density Test G _{mm}	Max. Specific Gravity MAMD	TM 305		T 209	2050	1st Sublot Daily or Min. 1/Day		

FIELD TESTED MATERIALS ACCEPTANCE GUIDE				(Revised November 2020)		Same Frequency for all Tests (Minimums)		
MATERIAL AND OPERATION	DESCRIPTION OF TEST	TEST METHOD			FORM 734-	QUALITY ASSURANCE		
		ODOT	WAQTC	AASHTO		Contractor Quality Control	Project Manager	Region Quality Assurance
SECTION 00744 - ASPHALT CONCRETE PAVEMENT (CONTINUED)								
Compaction	Nuclear Density			T 355	1793A			
								(D) Average 10 tests per Sublot or Min. 10/Day. See Section 00744.49

FIELD TESTED MATERIALS ACCEPTANCE GUIDE				(Revised November 2020)			Same Frequency for all Tests (Minimums)				
MATERIAL AND OPERATION	DESCRIPTION OF TEST	TEST METHOD			FORM 734-	QUALITY ASSURANCE					
		ODOT	WAQTC	AASHTO		Contractor Quality Control	Project Manager	Region Quality Assurance	Materials Laboratory		
SECTION 00745 - ASPHALT CONCRETE PAVEMENT - STATISTICAL ACCEPTANCE											
Aggregate Production	Soundness Abrasion Degradation Lightweight Pieces Plasticity Index	TM 208			4000	T 104 T 96 T 113 T 90					See Section 4A
(¹) QAE may waive after 5 sublots/shifts					4000			Submit to Lab			
(²) Perform a minimum of 3 tests QL's required									A Sublot equals 1000 Tons. A minimum one per shift whichever results in the greatest sampling frequency		
(³) Coarse Agg (+ No. 4)	Sampling Reducing				1792	R 90 R 76 T 27/T 11 T 176					
(⁴) Fine Agg (- No. 4)											1 per 10 Sublots
Note: Sample Aggregate before Lime Treatment		TM 229			1792	T 335			1/5 Sublots & Start of Production		
		TM 225									
RAS Production (Reclaimed Asphalt Shingles)	Sieve Analysis Deleterious Materials	TM 335			4000	T 27			1 / 500 Tons	Submit to Lab	
	Sampling Reducing Sieve Analysis Deleterious Materials	TM 335				R 90 R 76 T 27					
					1792				1 / 50 Tons		
Preproduced Aggregate											
Compliance of aggregates produced and stockpiled before the award date or notice to proceed of this contract will be determined by the following:											
1. Continuing production records meeting the above requirements of Section 00745.10 Aggregate Production.											
2. Furnish records of testing for the entire stockpile according to Section 00745.10 Aggregate Production except change the sampling frequency to the following:											
a. One Per 5 sublots means "One Set of Tests Per 5000 Tons".											
b. One Per sublot means "One Set of Tests Per 1000 Tons" with a minimum of 3 sets of Sieve Analysis tests per project.											
c. Provide one stockpile sample for each set of tests required above.											

FIELD TESTED MATERIALS ACCEPTANCE GUIDE				Same Frequency for all Tests (Minimums)			
MATERIAL AND OPERATION	DESCRIPTION OF TEST	TEST METHOD		FORM 734-	QUALITY ASSURANCE		
		ODOT	WAQTC		AASHTO	Contractor Quality Control	Project Manager
SECTION 00745 - ASPHALT CONCRETE PAVEMENT - STATISTICAL ACCEPTANCE (CONTINUED)							
A Sublot equals 1000 Tons							
Mixture Acceptance - ACP " With and Without RAP"							
Gradation	(1) Calibrate Incinerator	TM 323			2327IC	1/JMF & Each Calendar Year.	1/JMF & Each Calendar Year.
Ignition method	Sampling Reducing Sieve analysis			R 97 R 47 T 30		1/Sublot	1 per 10 Sublots
(Residual aggregate from AASHTO T 308)					2277		
(1) Submit Samples a minimum of 2 Days Prior to ACP Production							
A Sublot equals 1000 Tons							
Asphalt Content							
Ignition Method	(1) Calibrate Incinerator	TM 323			2327IC	1/JMF & Each Calendar Year.	1/JMF & Each Calendar Year.
Ignition Method	Sampling Reducing Asphalt Content			R 97 R 47 T 308		1/Sublot or Min. 1/day	1 per 10 Sublots
(2) RAP Percentage	Meter Method	TM 321			2277		
(2) If Applicable		(3) TM 322				1/Sublot or Minimum 1/Day	1 per 10 Sublots
(3) Required at start of production and if meters fail to meet specification	(2) RAP Moisture Cold Feed Moisture			T 329 T255/T265	2277		
Meter Method is required for ACP even when acceptance is by Ignition Method	Readings backed by Tank measure & Production Records Daily	TM 321 (3) TM 322				Daily Production	

FIELD TESTED MATERIALS ACCEPTANCE GUIDE				Same Frequency for all Tests (Minimums)			
MATERIAL AND OPERATION	DESCRIPTION OF TEST	TEST METHOD		FORM 734-	QUALITY ASSURANCE		
		ODOT	WAQTC		AASHTO	Contractor Quality Control	Project Manager
SECTION 00745 - ASPHALT CONCRETE PAVEMENT - STATISTICAL ACCEPTANCE (CONTINUED)							
A Sublot equals 1000 Tons							
Mixture Acceptance - ACP "With and Without RAP"							
Mix Design Verification Testing Fabrication Maximum Density Test	Gyratory Specimen Max. Specific Gravity	TM 326	T 209	2050GV 2050 *5068 *2560 *5069	1/Sublot & according to Section 00745.16 (b)-1-d		1 per 10 Sublots
Determination of G_{mb}	Bulk Specific Gravity		T 166				
Stripping Susceptibility	Tensile Strength Ratio		T 283	2050tsr	1/JMF See Section 00745.16 (b)-1-f		
*Cat-II complete & submit as required, See Section 745.16(b)							
Plant Discharge Moisture	Asphalt Mix Moist.		T 329	2277	1/Sublot		
Maximum Density Test G_{mm}	Max. Specific Gravity MAMD	TM 305	T 209	2050	1st Sublot Daily or Min. 1/Day		
Performing Control Strip	Control Strip	TM 306		2084 *5069	Develop Rolling Pattern See Specs.		
Compaction	Nuclear Density		T 355	1793A	(D) Average 5 tests per Sublot or Min. 1/Day, See Section 00745.49 (b)-2	(D) 1 per 10 Sublots	
Asphalt Cement	Compliance		R 66	4000	1/Sublot See Section 4C	Submit to Lab	1 per 10 Sublots
(D) See T 355 Yellow Sheet for Density Test Locations							1/5 QC Samples (Random)

FIELD TESTED MATERIALS ACCEPTANCE GUIDE				Same Frequency for all Tests (Minimums)		
MATERIAL AND OPERATION	DESCRIPTION OF TEST	TEST METHOD		FORM 734-	QUALITY ASSURANCE	
		ODOT	WAQTC		AASHTO	Contractor Quality Control
SECTION 00745 - ASPHALT CONCRETE PAVEMENT - STATISTICAL ACCEPTANCE (CONTINUED)						
Mixture Acceptance - ACP "With and Without RAP"						
Mix Design Verification Testing						
Lime						
Latex						
Lime or Latex Treatment of Aggregate (Stockpile or Mixture Production)						
⁽²⁾ Required at start of production and if meters fail to meet specification					2277	1 per 10 Sublots
					2277	
⁽¹⁾ If Applicable					2401 ACP	
Smoothness						
					TM 321	
					⁽²⁾ TM 322	
Certification of Profiler Equipment Determining Profile Index Determining International Roughness Index						
					Readings backed by Tank Measure & Production Records Daily	Daily Production
					TM 769 TM 770 TM 772	See Special Provisions

A Sublot equals 1000 Tons

Material must meet the requirements of Section 2090

See Special Provisions for Latex Requirements

FIELD TESTED MATERIALS ACCEPTANCE GUIDE				Same Frequency for all Tests (Minimums)				
MATERIAL AND OPERATION	DESCRIPTION OF TEST	TEST METHOD			FORM 734-	QUALITY ASSURANCE		
		ODOT	WAQTC	AASHTO		Contractor Quality Control	Project Manager	Region Quality Assurance
SECTION 00754 - PLAIN CONCRETE PAVEMENT REPAIR								
SECTION 00755 - CONTINUOUSLY REINFORCED CONCRETE PAVEMENT								
SECTION 00756 - PLAIN CONCRETE PAVEMENT								
SECTION 00758 - CONTINUOUSLY REINFORCED CONCRETE PAVEMENT REPAIR								
Aggregate Production								
(1) QAE may waive after 5 sublots/shifts	Sampling Reducing	R 90 R 76 T 27/T 11			1792			
(2) Perform a minimum of 3 tests, QL's required	(2)(3)(4) Sieve Analysis (4) Fineness Modulus (4) Sand Equivalent	T 176			1792			1 per 10 Sublots
(3) Coarse Aggregate (See Section 02690.20)	(3) Fracture (Method 2) (1)(3) Elongated Pieces	TM 225 TM 229			1792 1792			
(4) Fine Aggregate (See Section 02690.30)	Abrasion Degradation Soundness Lightweight Pieces Organics	TM 208			4000 4000		Submit to Central Lab	See Section 4A & 02690
	(3) Dry Rodded Unit Weight (3)(4) Bulk Specific Gravity & Absorption	T 19 T 84 & T 85			1825 1825C 1825			Start of production and when changes in aggregate occurs
A Sublot equals 1000 Tons								
See Section 4A								

FIELD TESTED MATERIALS ACCEPTANCE GUIDE				(Revised November 2020)				Same Frequency for all Tests (Minimums)			
MATERIAL AND OPERATION	DESCRIPTION OF TEST	TEST METHOD			FORM 734-	QUALITY ASSURANCE					
		ODOT	WAQTC	AASHTO		Contractor Quality Control	Project Manager	Region Quality Assurance	Materials Laboratory		
SECTION 00850 - COMMON PROVISIONS FOR PAVEMENT MARKINGS											
Placement Evaluation "Retroreflectivity"											
In-Place Procedure evaluates Durable and High Performance Pavement Markings	Evaluation of Retroreflectivity Using Hand-Operated Instrument	TM 777			4101 thru 4105	See Special Provisions and Test Procedure for Testing Frequency					

FIELD TESTED MATERIALS ACCEPTANCE GUIDE				Same Frequency for all Tests (Minimums)					
MATERIAL AND OPERATION	DESCRIPTION OF TEST	TEST METHOD			FORM 734-	QUALITY ASSURANCE			
		ODOT	WAQTC	AASHTO		Contractor Quality Control	Project Manager	Region Quality Assurance	Materials Laboratory
SECTION 00921 - MAJOR SIGN SUPPORT DRILLED SHAFTS									
Aggregate Production									
(1) QAE may waive after 5 sublots/shifts	Sampling Reducing (2)(3)(4) Sieve Analysis (4) Fineness Modulus (1)(3) Wood Particles (4) Sand Equivalent	TM 225	R 90 R 76 T 27/T 11 T 27/T 11	AASHTO	1792	1 per 10 Sublots	1/Sublot & Start of Production	Submit to Lab	See Section 4(A)
(2) Perform a minimum of 3 tests, QL's required	Soundness Abrasion Degradation Lightweight Pieces Organics	TM 208	T 104 T 96 T 113 T 21	AASHTO	4000	See Section 4A	See Section 4A	Submit to Lab	See Section 4(A)
(3) Coarse Aggregate (See Section 02690.20)	(3) Dry Rodded Unit Weight		T 19	AASHTO	1825 1825C	Start of production and when changes in aggregate occurs			
(4) Fine Aggregate (See Section 02690.30)	(3)(4) Bulk Specific Gravity & Absorption		T 84 & T 85	AASHTO	1825				
Portland Cement Modifiers Admixtures	Materials must meet the requirements of Section 02001.10								
Drilling Slurry	Slurry material must meet the requirements of Section 00921.14 & 00921.43(g)								
Grout	Material must meet the requirements of Section 02080								
Mixing Water	Material must meet the requirements of Section 02020								

FIELD TESTED MATERIALS ACCEPTANCE GUIDE					(Revised November 2020)			Same Frequency for all Tests (Minimums)		
MATERIAL AND OPERATION	DESCRIPTION OF TEST	TEST METHOD			FORM 734-	QUALITY ASSURANCE				
		ODOT	WAQTC	AASHTO		Contractor Quality Control	Project Manager	Region Quality Assurance	Materials Laboratory	
SECTION 00921 - MAJOR SIGN SUPPORT DRILLED SHAFTS										
Portland Cement Concrete	Sampling Slump Concrete Temperature Density (Unit Weight) Yield Water/Cement Ratio Strength		TM 2	T 119 T 309 T 121 T 121 T 121	3573WS or 4000C 4000C					QA Testing
(S) 1 Set Represents a minimum of 3 Cylinders						(M) (S) 1 per Shaft and Test at minimum frequencies according to table 00512-1. Review specs.				<u>Projects under 100 yd³ all classes</u> 1/Project representing all classes of PCC
(M) Per Mix Design & Source										<u>Projects over 100 yd³ all classes</u> 1/500 yd ³ per class minimum 1/class
TABLE 00512-1 Frequency of Quality Control Testing										
Minimum frequencies per Class of concrete based on daily production records.										
Production		0 to 100 yd ³ on a single day		1 Set each day		Frequencies				
Quantity Over 100 yd³		100 to 600 yd ³ on a single day		1 Set per each 100 yd ³ or portion thereof		1 Set per each 200 yd ³ or portion thereof after reaching 600 yd ³				

INSERT TAB

SECTION 5
Field Tested Materials
Guide (Type D&E Projects)

HOW TO USE THE FIELD TESTED MATERIALS ACCEPTANCE GUIDE FOR TYPE D OR E PROJECTS ONLY

The use of this guide will only be allowed when specifically called out in Section 00165. 10 (a) of the project Special Provisions. This guide summarizes the testing requirements for various materials used in the construction of ODOT/ Local Agency projects. It indicates what tests must be performed, who must perform them, and how frequently they must be performed. It includes materials which are sampled and tested in the field and materials which are field sampled but sent elsewhere for testing. When a contract requires Quality Control (QC) by the Contractor, samples that must be sent elsewhere for testing are delivered to the Project Manager along with the Sample Data Sheet (Form 734-4000). Examples of this and other test report forms are in Section 3 of this manual.

Materials in this guide are listed in the numerical order of the Standard Specifications and the project special provisions. To find the testing requirements for a particular material, first determine what it will be used for and then refer to the appropriate Specifications Section for that product. For example, to look up testing requirements for aggregate to be used in asphalt concrete paving, refer to Section 00745.

Definitions

SAMPLE SIZES – Refer to Section 4(C) for guidance on material sample sizes, containers, and labeling. Although designed for the ODOT Central Materials Laboratory (ODOT-CML), it is a good guide for samples being sent to any laboratory.

ASPHALT CONCRETE MIX DESIGNS – If the ODOT-CML is preparing the AC mix design, submit samples of the materials shown in Section 4(C) of this manual.

TYPES OF TESTS For TYPE D OR E PROJECTS ONLY

This Section is only to be used on projects where the Special Provisions specifically call out Contractor Quality Control Type D or E. The following types of tests will be performed by the Contractor or Engineer on materials and products required for contract work:

1. **Source Review** – This test type is addressed in Section 4(A) of this Manual. The Engineer will test unprocessed material from an aggregate source, if requested by the Contractor, to provide information about the quality of material. Tests will involve degradation, soundness, and abrasion, but may involve other tests. Favorable test results do not imply that processed material from the source will comply with specifications after it is processed as required for the project.
2. **Product Compliance** – This test type is addressed in Section 4(A) of this Manual. This section shall be complied with except that under Product Compliance the contractor may elect to use the ODOT Central Laboratory or a nationally credited private laboratory approved by the Engineer. The material shall not be incorporated into the project unless Product Compliance tests show favorable results.
3. **Quality Control** – The Contractor will perform quality control testing as described in Section 2 and specified in Section 5 of this Manual or as modified by the Special Provisions or Supplemental Standard Specifications.
4. **Quality Assurance** – The Engineer shall review documentation to assure its accuracy and completeness. The Engineer may elect to have additional testing performed by certified technicians.
5. **Production Control Testing** – Testing performed by the contractor or producer at a rate that assures the provided material meets the quality specified.
6. **Visual** – Visual Inspection: Examination and assessment of construction materials, by **OBSERVATION**, to determine if the materials appear to meet the contract requirements and are acceptable for incorporation into construction projects. Visual inspection, when stated in the contract, is a method generally used by the Project Inspector in lieu of normal sampling and testing of field tested materials as defined in section 00165.00 of the Standard Specifications to document quality. Supporting documentation for visual acceptance is, at a minimum, a field inspection report. Consult the construction contract for other acceptance document requirements.

FIELD TESTED MATERIALS ACCEPTANCE GUIDE

(Revised November 2020)

Same Frequency for all Tests (Minimums)

MATERIAL AND OPERATION	DESCRIPTION OF TEST	TEST METHOD			FORM 734-	Quality Control		Quality Assurance
		ODOT	WAQTC	AASHTO		Contractor Quality Control Type D	Contractor Quality Control Type E	
SECTION 00330-EARTHWORK								
(See Sec. 330.16(a)) Soil and Soil/Aggregate Mixtures	Gradation						Contractor Quality Control Type D Contractor Quality Control Type E	Project Manager Type D & E
Establishing Maximum Density (for Compaction)	Density Curve			T 99	3468		Requires Signed and Notarized Statement of Compliance From Contractor For All Items Under Section 00300	Review Documentation for Acceptance
	Bulk Specific Gravity			T 85	3468			
	Family of Curves			R 75	3468FC		Visual	
Compaction	Deflection Testing	TM 158			1793S	1 Test per 3 ft. in depth	Visual	Review Documentation for Acceptance
	Nuclear Gauge Coarse Particle Correction			T 310	1793S	See Table 00330-1 Below		
	Deflection Testing	TM 158			1793S		Visual	

TABLE 00330-1 Frequency of Quality Control Testing

Individual Areas	Under 3500 yd ² or yd ³	Over 3500 yd ² or yd ³
Existing Ground Surface	1 test per 1000 yd ²	1 test per 3000 yd ²
Embankments	1 test per 500 yd ³	1 test per 3000 yd ³
Excavations and Finished Subgrade	1 test per 1000 yd ²	1 test per 3000 yd ²
Gradation	Contractor Furnished Testing	Visual
	1 per Layer	
Deflection Testing	TM 158	1793S
<p>Contractor must demonstrate, by compaction testing or acceptable visual means, that the material, equipment, and process used for compaction achieves the specification requirements. If the material, equipment, or process changes, or if other conditions indicate a non-specification product, the Contractor must re-demonstrate that specification requirements are being achieved.</p>		
Imported Topsoil (See Section 01040.14(b))	Compliance	Contractor Testing 1/Source & 1/Soil type
		4000
		Visual
		Review Documentation for Acceptance

FIELD TESTED MATERIALS ACCEPTANCE GUIDE				(Revised November 2020)			Same Frequency for all Tests (Minimums)		
MATERIAL AND OPERATION	DESCRIPTION OF TEST	TEST METHOD			FORM 734-	Quality Control		Quality Assurance	
		ODOT	WAQTC	AASHTO		Contractor Quality Control Type D	Contractor Quality Control Type E		
SECTION 00331 - SUBGRADE STABILIZATION Aggregate backfill	Material must meet the requirements of Section 00331.10							Review Documentation for Acceptance	
					Contractor Testing				
					Contractor Testing	Visual			
Water	Material must meet the requirements of Section 00340								
						Visual			
Compaction	Material must meet the requirements of Section 00331								
SECTION 00332 - SURFACING STABILIZATION Aggregate Base	Material must meet the requirements of Section 00332.10								
						Visual			
Compaction	Material must meet the requirements of Section 00332								
						Visual			
SECTION 00333 - AGGREGATE DITCH LINING Aggregate	Sampling Reducing Sieve Analysis								
					R 90 R 76 T 27/T 11				
						1/Project or 1/Source	Visual	Review Documentation for Acceptance	

FIELD TESTED MATERIALS ACCEPTANCE GUIDE				(Revised November 2020)		Same Frequency for all Tests (Minimums)		
MATERIAL AND OPERATION	DESCRIPTION OF TEST	TEST METHOD		FORM 734-	Quality Control		Quality Assurance	
		ODOT	WAQTC		AASHTO	Contractor Quality Control Type D		Contractor Quality Control Type E
SECTION 00344 - TREATED SUBGRADE								
Granular Quicklime	Sieve Analysis Calcium Hydroxide Content in lime			T 27 T 219	4000	Contractor Testing 1/Source	Manufacture Compliance Statement	Review Documentation for Acceptance
Hydrated Lime Calcium Chloride Sodium Chloride	Materials must meet the requirements of Section 00344.10 and Test Results Certificate provided according to Section 00165.35(a)							
Portland Cement Water	Material must meet the requirements of Section 02010							
Establishing Maximum Density (for Compaction)	Material must meet the requirements of Section 00340							
Compaction	Density Curve Maximum Specific Gravity				3468	See Special Provisions and Table 00344-1 Below	Visual	Review Documentation for Acceptance
					1793S			
	Deflection Testing Nuclear Gauge Coarse Particle Correction	TM 158	T 310 T 99	1793S				
		TM 158						
TABLE 00344-1 Frequency of Quality Control Testing								
Individual Areas				Under 3500 yd²		Over 3500 yd²		
Finished Subgrade				1 test per 1000 yd ²		1 test per 3000 yd ²		

FIELD TESTED MATERIALS ACCEPTANCE GUIDE

(Revised November 2020)

Same Frequency for all Tests (Minimums)

MATERIAL AND OPERATION	DESCRIPTION OF TEST	TEST METHOD			FORM 734-	Quality Control			Quality Assurance					
		ODOT	WAQTC	AASHTO		Contractor Quality Control Type D	Contractor Quality Control Type E	Project Manager Type D & E						
SECTION 00360 - Drainage Blankets														
Granular Drainage Blanket	Sampling Reducing Gradation			R 90 R 76 T 27/T 11	1792	1/sublot minimum 1/Source per Project	Visual	A sublot equals 1000 Tons	Review Documentation for Acceptance					
Sand Drainage Blanket	Sampling Reducing Gradation			R 90 R 76 T 27/T 11	1792									
Establishing Maximum Density (for Compaction)	Density Curve			T 99	3468	1/Source and Type								
	Bulk Specific Gravity			T 85	3468									
Compaction	Deflection Testing	TM 158			1793S	1 Test per 3 ft. in depth								
	Deflection Testing Nuclear Gauge Coarse Particle Correction	TM 158		T 310 T 99	1793S	See Table 00360-1 Below	Visual		Review Documentation for Acceptance					
					1793S									
TABLE 00360-1 Frequency of Quality Control Testing														
Individual Areas					Under 3500 yd²					Over 3500 yd²				
Existing Ground Surface					1 test per 1000 yd ²					1 test per 3000 yd ²				
Finished Surfaces					1 test per 1000 yd ²					1 test per 3000 yd ²				

FIELD TESTED MATERIALS ACCEPTANCE GUIDE				(Revised November 2020)				Same Frequency for all Tests (Minimums)			
MATERIAL AND OPERATION	DESCRIPTION OF TEST	TEST METHOD			FORM 734-	Quality Control		Quality Assurance			
		ODOT	WAQTC	AASHTO		Contractor Quality Control Type D	Contractor Quality Control Type E				
SECTION 00390 - RIPRAP PROTECTION											
Fill Material & Riprap	Gradation See 00390.11(c)1					Contractor Furnished Testing	Visual	Review Documentation for Acceptance			
	Degradation Soundness	TM 208		T 104 T 85	4000 1825	Contractor Furnished Testing	Provide History of Passing Tests				
	Apparent Specific Gravity & Absorption					Contractor Testing When Required	Visual				
	Gradation See 00390.13			R 90 R 76 T 27/T 11	1792	1/Project	Visual				
Filter Blanket											
Grouted Riprap Sand	Sampling Reducing Sieve Analysis							Review Documentation for Acceptance			
	Soundness Lightweight Pieces			T 104 T 113	4000	Contractor Furnished Testing	Provide History of Passing Tests				
Material must meet the requirements of Section 02010											
Portland Cement											

FIELD TESTED MATERIALS ACCEPTANCE GUIDE				FORM 734- (Revised November 2020)		Same Frequency for all Tests (Minimums)	
MATERIAL AND OPERATION	DESCRIPTION OF TEST	TEST METHOD		FORM 734-	Quality Control		Quality Assurance
		ODOT	WAQTC		AASHTO	Contractor Quality Control Type D	
SECTION 00396 -SHOTCRETE SLOPE STABILIZATION							
Aggregate Production and Mixture							A Sublot equals 1000 Tons
(1) QAE may waive after 5 sublots/shifts	Sampling Reducing			R 90 R 76			Review Documentation for Acceptance
(2) Coarse Aggregate (See Section 02690.20)	(2)(3) Sieve Analysis (3) Fineness Modulus (1)(2) Wood Particles (3) Sand Equivalent	TM 225		T 27/T 11 T 27/T 11 T 176		Provide History of Passing Tests	
(3) Fine Aggregate (See Section 02690.30)	Soundness Abrasion Degradation Lightweight Pieces Organics	TM 208		T 104 T 96 T 113 T 21	4000	Contractor Furnished Testing	
	(2) Dry Rodded Unit Weight (2)(3) Bulk Specific Gravity & Absorption			T 19 T 84 & T 85		Start of production and when changes in aggregate occurs	
Portland Cement Admixtures							
Mixing Water							
Production Testing (See Section 00396.14)							
(S) 3 Cores minimum per Panel							
Compression Test Cores	Strength			T 22	4000C	Two Test Panels per Mix Design & Two Panels per days Production See Section 00396.14(a)2	Review Documentation for Acceptance
						Two Test Panels per Mix Design & Two Panels per days Production See Section 00396.14(a)2	
						1/Set Cores per Test panel	

FIELD TESTED MATERIALS ACCEPTANCE GUIDE

(Revised November 2020)

MATERIAL AND OPERATION	DESCRIPTION OF TEST	TEST METHOD			FORM 734-	Same Frequency for all Tests (Minimums)		
		ODOT	WAQTC	AASHTO		Contractor Quality Control Type D	Contractor Quality Control Type E	Quality Assurance
SECTION 00405 - TRENCH EXCAVATION, BEDDING, AND BACKFILL								
TRENCH FOUNDATION (Excavation Below Grade Only)								
Selected general backfill								Requires Signed and Notarized Statement of Compliance From Contractor For All Items Under Section 00400
Selected granular backfill	Material must meet the requirements of Section 00330.13						Contractor Furnished Testing	
Selected stone backfill	Material must meet the requirements of Section 00330.14							
Other approved material	Material must meet the requirements of Section 00330.15							
	Material must meet the requirements of Section 00405.11					Visual		
Establishing Maximum Density	Density Curve			T 99	3468		Visual	Review Documentation for Acceptance
	Bulk Specific Gravity			T 85	3468			
	Family of Curves			R 75	3468FC			
	Nuclear Gauge			T 310	1793S			
Compaction	Coarse Particle Correction			T 99		1 Test per 300 ft. of Trench	Visual	

Contractor must demonstrate, by compaction testing or acceptable visual means, that the material, equipment, and process used for compaction achieves the specification requirements. If the material, equipment, or process changes, or if other conditions indicate a non-specification product, the Contractor must re-demonstrate that specification requirements are being achieved.

FIELD TESTED MATERIALS ACCEPTANCE GUIDE

(Revised November 2020)

Same Frequency for all Tests (Minimums)

MATERIAL AND OPERATION	DESCRIPTION OF TEST	TEST METHOD			FORM 734-	Quality Control			Quality Assurance
		ODOT	WAQTC	AASHTO		Contractor Quality Control Type D	Contractor Quality Control Type E	Project Manager Type D & E	
SECTION 00405 - TRENCH EXCAVATION, BEDDING, AND BACKFILL (CONTINUED)									
Bedding									
3/8" - 0 PCC fine aggregate (See Section 02690.30(h))	Sampling Reducing Sieve Analysis			R 90 R 76 T 27/T 11	1792	Contractor Provided Testing	Visual	Review Documentation for Acceptance	
Commercial 3/4" - 0 Aggregate						Contractor Provided Testing	Visual		
No. 10 - 0 Sand drainage blanket material (See Section 00360.10)	Sampling Reducing Sieve Analysis			R 90 R 76 T 27/T 11	1792	Contractor Provided Testing	Visual		
Reasonably well graded sand, maximum 3/8" to dust						Contractor Provided Testing	Visual		
Commercial available 3/8"-0 or No.10 - 0 sand						1 per Sublot	Visual		
Continuous cradle of Commercial Grade Concrete						Contractor Provided Testing	Visual	Review Documentation for Acceptance	

FIELD TESTED MATERIALS ACCEPTANCE GUIDE				(Revised November 2020)		Same Frequency for all Tests (Minimums)		
MATERIAL AND OPERATION	DESCRIPTION OF TEST	TEST METHOD		FORM 734-	Quality Control		Quality Assurance	
		ODOT	WAQTC		AASHTO	Contractor Quality Control Type D		Contractor Quality Control Type E
SECTION 00405 - TRENCH EXCAVATION, BEDDING, AND BACKFILL (CONTINUED)								
Pipe Zone Material								
Flexible Pipe								
Use the Listed Material requirements under Bedding								
Rigid Pipe: Aggregate Base 1" - 0 or 3/4" - 0 Aggregate (See Section 02630.10)	Sampling Reducing Sieve Analysis				R 90			Review Documentation for Acceptance
					R 76		Visual	
					T 27	1792	Visual	
Rigid Pipe: Commercial 1" - 0 or 3/4" - 0 Aggregate						Contractor Provided Testing	Visual	Review Documentation for Acceptance
Establishing Maximum Density (¹) Method "A" & ODOT TM 223 for Dense Graded Base Aggregate	Density Curve				(¹) T 99		1/Source or Aggregate Gradation	Visual
	Bulk Specific Gravity				T 85			
	Coarse Particle Correction				T 99			
Compaction	Nuclear Gauge				T 310		1 test per 100 ft. of Trench and every 2.0 ft. of Fill	Visual
						1793B		
<p align="center">Contractor must demonstrate, by compaction testing or acceptable visual means, that the material, equipment, and process used for compaction achieves the specification requirements. If the material, equipment, or process changes, or if other conditions indicate a non-specification product, the Contractor must re-demonstrate that specification requirements are being achieved.</p>								

FIELD TESTED MATERIALS ACCEPTANCE GUIDE				(Revised November 2020)		Same Frequency for all Tests (Minimums)		
MATERIAL AND OPERATION	DESCRIPTION OF TEST	TEST METHOD			FORM 734-	Quality Control		Quality Assurance
		ODOT	WAQTC	AASHTO		Contractor Quality Control Type D	Contractor Quality Control Type E	
SECTION 00405 - TRENCH EXCAVATION, BEDDING, AND BACKFILL (CONTINUED)								
Trench Backfill								
Class A Backfill - Native or common Material		Material must meet the requirements of Section 00330.43				Contractor Provided Testing	Visual	Review Documentation for Acceptance
Class B Backfill - 1"-0 or 3/4"-0 Granular Material		Material must meet the requirements of Section 00641				Contractor Provided Testing	Visual	Review Documentation for Acceptance
Class C Backfill - Clean sand with 100% minus 1/4" material						Contractor Provided Testing	Visual	Review Documentation for Acceptance
Class D Backfill - Pit run or bar run material with 3" maximum dimension and well graded from coarse to fine						Contractor Provided Testing	Visual	Review Documentation for Acceptance
Class E Backfill - Controlled Low Strength Material (CLSM)		Material must meet the requirements of Section 00442				Contractor Provided Testing	Visual	Review Documentation for Acceptance
Establishing Maximum Density	Density Curve			(1) T 99	3468	1/Soil Type or Aggregate Gradation		
(1) Method "A" & ODOT TM 223 for Dense Graded Base Aggregate	Bulk Specific Gravity			T 85	3468			
	Family of Curves			R 75	3468FC			
	Nuclear Gauge Coarse Particle Correction			T 310 T 99	1793S or 1793B	(C) 1 test per 100 ft. of Trench and every 2.0 ft. of Fill	Visual	Review Documentation for Acceptance
Compaction								
(C) Density testing is based on cumulative lineal meters or feet of pipe placement.								
Contractor must demonstrate, by compaction testing or acceptable visual means, that the material, equipment, and process used for compaction achieves the specification requirements. If the material, equipment, or process changes, or if other conditions indicate a non-specification product, the Contractor must re-demonstrate that specification requirements are being achieved.								

FIELD TESTED MATERIALS ACCEPTANCE GUIDE				(Revised November 2020)		Same Frequency for all Tests (Minimums)				
MATERIAL AND OPERATION	DESCRIPTION OF TEST	TEST METHOD			FORM 734-734-	Quality Control		Quality Assurance		
		ODOT	WAQTC	AASHTO		Contractor Quality Control Type D	Contractor Quality Control Type E			
SECTION 00430 - SUBSURFACE DRAINS										
Granular Drain Backfill Material	Sampling Reducing Sieve Analysis	R 90 R 76 T 27	TM 208	See section 405 for compaction requirements	1792	A Sublot equals 1000 Tons	Visual	Review Documentation for Acceptance		
									4000	Minimum 1 Per Project
Special Filter Material See Section 00430.46(a)	Compaction									
SECTION 00440 - COMMERCIAL GRADE CONCRETE										
Mixture	Sampling Air Content Density (Unit Weight) Slump Concrete Temperature	TM 2	T 152 T 121 T 119 T 309	3573WS or 4000C		Contractor Provided Testing	Contractor Provided Testing	Contractor Quality Control Type E		
									Material must meet the requirements of Section 02030	Manufacture Compliance Statement
Material must meet the requirements of Section 02010										
Modifiers Admixtures Portland Cement	Strength	T 22 & T 23	4000C	(M) (S) 1 Set / Day Minimum	Contractor Provided Testing	Review Documentation for Acceptance	Contractor Quality Control Type E	Project Manager Type D & E		
Structural Items	Strength	T 22 & T 23	4000C	(M) (S) 1 Set/20 yd ³ Cumulative (Maximum 1 Set/day)	Contractor Provided Testing	Review Documentation for Acceptance	Contractor Quality Control Type E	Project Manager Type D & E		
Except Visual Acceptance Items (See section 00440.14(a))										
(S) 1 Set Represents a minimum of 3 Cylinders										
(M) Per Mix Design & Source										

FIELD TESTED MATERIALS ACCEPTANCE GUIDE				(Revised November 2020)		Same Frequency for all Tests (Minimums)		
MATERIAL AND OPERATION	DESCRIPTION OF TEST	TEST METHOD			FORM 734-734-	Quality Control		Quality Assurance
		ODOT	WAQTC	AASHTO		Contractor Quality Control Type D	Contractor Quality Control Type E	
SECTION 00442 - CONTROLLED LOW STRENGTH MATERIALS (CLSM)								
CLSM Mixture	Mix Proportions Trial Batch Strength			AASHTO		Contractor Quality Control Type D	Contractor Quality Control Type E	Project Manager Type D & E
				T 22 & T 23	4000C	1/Project or Source	Contractor Provided Testing	Review Documentation for Acceptance
Modifiers		Material must meet the requirements of Section 02030						Review Documentation for Acceptance
Admixtures		Material must meet the requirements of Section 02040						
Portland Cement		Material must meet the requirements of Section 02010					Manufacture Compliance Statement	
SECTION 00445 - SANITARY, STORM, CULVERT, SIPHON, AND IRRIGATION PIPE - INCLUDED WITH SECTION 00405								
Trench Work								
Excavation, bedding, pipe zone and trench backfill								Review Documentation for Acceptance
	See Section 00405 for pipes less than 72"					Contractor Provided Testing	Contractor Provided Testing	
Excavation, bedding, pipe zone and trench backfill								Review Documentation for Acceptance
	See Section 00510 for pipes greater than 72"					Contractor Provided Testing	Contractor Provided Testing	
Concrete Blocks								
	Material must meet the requirements of Section 00440							

FIELD TESTED MATERIALS ACCEPTANCE GUIDE				(Revised November 2020)		Same Frequency for all Tests (Minimums)		
MATERIAL AND OPERATION	DESCRIPTION OF TEST	TEST METHOD		FORM 734-	Quality Assurance			
		ODOT	WAQTC		AASHTO	Contractor Quality Control Type D	Contractor Quality Control Type E	Project Manager Type D & E
SECTION 00450 - STRUCTURAL PLATE PIPE, PIPE ARCH AND ARCH								
Commercial Grade Concrete in appurtenances	Material must meet the requirements of Section 00440							
Trench Work								
Excavation and Backfill	Operations must meet the requirements of Section 00510							
Trenches in Unstable Areas								
Granular Structural Backfill	Material must meet the requirements of Section 00510							
Establishing Maximum Density								
⁽¹⁾ Method "A"	Density Curve			⁽¹⁾ T 99	3468 B	Contractor Provided Testing	Visual	Review Documentation for Acceptance
	Bulk Specific Gravity Coarse Particle Correction	TM 223		T 85		Contractor Provided Testing	Visual	
Compaction	Nuclear Gauge			T 310	1793 B	Contractor Provided Testing	Visual	Review Documentation for Acceptance
Structure Backfill (Section 00450.46)	Material and Operation must meet the requirements of Section 00510.48(d)							
SECTION 00459 - CAST IN PLACE CONCRETE PIPE								
Concrete	Material must meet the requirements of Section 00540, with acceptance in accordance with Section 00540.17							
Backfill Material	Contractor Provided Testing					Contractor Provided Testing	Visual	Review Documentation for Acceptance
	Contractor Provided Testing					Contractor Provided Testing	Visual	

FIELD TESTED MATERIALS ACCEPTANCE GUIDE				(Revised November 2020)		Same Frequency for all Tests (Minimums)		
MATERIAL AND OPERATION	DESCRIPTION OF TEST	TEST METHOD			FORM 734-	Quality Control		Quality Assurance
		ODOT	WAQTC	AASHTO		Contractor Quality Control Type D	Contractor Quality Control Type E	
SECTION 00460 - PAVED CULVERT END SLOPES								
Commercial Grade Concrete	Material must meet the requirements of Section 00440					Contractor Provided Testing	Contractor Provided Testing	Review Documentation for Acceptance
SECTION 00470 - MANHOLES, CATCH BASINS AND INLETS								
Commercial Grade Concrete	Material must meet the requirements of Section 00440							
Base Drain Backfill	Material must meet the requirements of Section 00470.17					Contractor Provided Testing	Visual	Review Documentation for Acceptance
Excavation, Backfill and Foundation Stabilization	Material must meet the requirements of Section 00405							
SECTION 00480 - DRAINAGE CURBS								
Commercial Grade Concrete	Material must meet the requirements of Section 00440					Contractor Provided Testing	Visual	Review Documentation for Acceptance
Dense Graded HMA Mixture Level 2, (1/2")	Material must meet the requirements of Section 00744							

FIELD TESTED MATERIALS ACCEPTANCE GUIDE				(Revised November 2020)		Same Frequency for all Tests (Minimums)		
MATERIAL AND OPERATION	DESCRIPTION OF TEST	TEST METHOD		FORM 734-	Quality Control		Quality Assurance	
		ODOT	WAQTC		AASHTO	Contractor Quality Control Type D		Contractor Quality Control Type E
SECTION 00490 - WORK ON EXISTING SEWERS AND STRUCTURES								
Commercial Grade Concrete	Material must meet the requirements of Section 00440							
High Early Strength Concrete	Material must meet the requirements of Section 00440, but cement contents adjusted according to 00490.11				Contractor Provided Testing	Visual	Review Documentation for Acceptance	
Backfill Operations	Backfill Excavations according to section 405							
Filling Abandoned Pipes, Manholes and Catch Basins (See section 00490.44)								
Backfill Operations (Roadway)	Material must meet the requirements of Section 2630							
Establishing Maximum Density (¹) Method "A"	Density Curve	(¹) T 99			Contractor Provided Testing	Visual	Review Documentation for Acceptance	
	Bulk Specific Gravity Coarse Particle Correction	T 85	TM 223	3468 B				
Compaction	Nuclear Gauge	T 310		1793B	1 Test per 100 ft. and every 1.5' of Fill	Visual		
	Material must meet the requirements of Section 00330.13				Contractor Provided Testing	Visual	Review Documentation for Acceptance	
Backfill Operations Landscaped or Unimproved Roadways	Material must meet the requirements of Section 00330.11							
Top 1.0' of Backfill Region	Material must meet the requirements of Section 00330.11							
SECTION 00495 - TRENCH RESURFACING								
Resurfacing Materials	See Section 00495.40 for Material Requirements				Contractor Provided Testing	Visual	Review Documentation for Acceptance	

FIELD TESTED MATERIALS ACCEPTANCE GUIDE				(Revised November 2020)		Same Frequency for all Tests (Minimums)		
MATERIAL AND OPERATION	DESCRIPTION OF TEST	TEST METHOD		FORM 734-	Quality Control		Quality Assurance	
		ODOT	WAQTC		AASHTO	Contractor Quality Control Type D		Contractor Quality Control Type E
SECTION 00510 - STRUCTURE EXCAVATION AND BACKFILL								
Soils, Soil/Aggregate Mixtures and Graded Aggregates								
Granular Structure Backfill (See Section 02630.10)	Sampling Reducing (¹) Sieve Analysis Fracture (Method 1) Sand Equivalent			R 90	1/Sublot (Minimum 1/Project)	Requires Signed and Notarized Statement of Compliance From Contractor For All Items Under Section 00500	Review Documentation for Acceptance	
				R 76				
⁽¹⁾ Perform a minimum of 3 tests QL's required				T 27	Contractor Provided Testing	Minimum 1 per Project	Review Documentation for Acceptance	
				T 335				
Product Compliance	Abrasion Degradation Plasticity Index Sieve Analysis		TM 208	T 176	Contractor Provided Testing	Minimum 1 per Project	Review Documentation for Acceptance	
				T 96				
Establishing Maximum Density	Density Curve			T 90	Contractor Provided Testing	Minimum 1 per Project	Review Documentation for Acceptance	
				T 11				
⁽²⁾ Method "A" & ODOT TM 223 for Dense Graded Base Aggregate	Bulk Specific Gravity			(²) T 99	1/Soil type or Aggregate Gradation	Visual	Review Documentation for Acceptance	
				T 85				
Compaction	Coarse Particle Correction			T 99	Min of 1 per lift	Visual	Review Documentation for Acceptance	
				T 310				
<p style="text-align: center;">Contractor must demonstrate, by compaction testing or acceptable visual means, that the material, equipment, and process used for compaction achieves the specification requirements. If the material, equipment, or process changes, or if other conditions indicate a non-specification product, the Contractor must re-demonstrate that specification requirements are being achieved.</p>								

FIELD TESTED MATERIALS ACCEPTANCE GUIDE				(Revised November 2020)		Same Frequency for all Tests (Minimums)		
MATERIAL AND OPERATION	DESCRIPTION OF TEST	TEST METHOD		FORM 734-	Quality Control		Quality Assurance	
		ODOT	WAQTC		AASHTO	Contractor Quality Control Type D		Contractor Quality Control Type E
SECTION 00510 - STRUCTURE EXCAVATION AND BACKFILL (CONTINUED)								
Soils, Soil/Aggregate Mixtures and Graded Aggregates								
Granular Wall Backfill (See Section 02630.11) ⁽¹⁾ Perform a minimum of 3 tests QL's required	Sampling Reducing ⁽¹⁾ Sieve Analysis Fracture (Method 2)	R 90 R 76 T 27 T 335	T 96	1792	1/Sublot (Minimum 1/Project)	Contractor Provided Testing	Review Documentation for Acceptance	
					Contractor Provided Testing	Contractor Provided Testing		
					Contractor Provided Testing	Minimum 1 per Project		
Product Compliance	Abrasion Degradation	TM 208	4000		Contractor Provided Testing	Visual	Review Documentation for Acceptance	
⁽²⁾ Compaction	⁽²⁾ Deflection Testing	TM 158		1793B	1/Sublot (Minimum 1/Project)	Visual		
<p>Note: Compaction must meet the requirements of section 00330.43c</p> <p>Contractor must demonstrate, by compaction testing or acceptable visual means, that the material, equipment, and process used for compaction achieves the specification requirements. If the material, equipment, or process changes, or if other conditions indicate a non-specification product, the Contractor must re-demonstrate that specification requirements are being achieved.</p>								

FIELD TESTED MATERIALS ACCEPTANCE GUIDE				(Revised November 2020)		Same Frequency for all Tests (Minimums)					
MATERIAL AND OPERATION	DESCRIPTION OF TEST	TEST METHOD		FORM 734-734-	Quality Control		Quality Assurance				
		ODOT	WAQTC		AASHTO	Contractor Quality Control Type D		Contractor Quality Control Type E			
SECTION 00512 - DRILLED SHAFTS											
Aggregate Production											
(1) QAE may waive after 5 sublots/shifts (2) Perform a minimum of 3 tests QL's required (3) Coarse Aggregate (See Section 02690.20) (4) Fine Aggregate (See Section 02690.30)	Sampling Reducing (2)/(3)/(4) Sieve Analysis (4) Fineness Modulus (1)/(3) Wood Particles (4) Sand Equivalent Soundness Abrasion Degradation Lightweight Pieces Organics (3) Dry Rodded Unit Weight (3)/(4) Bulk Specific Gravity & Absorption	TM 225	R 90 R 76 T 27/T 11 T 27/T 11 T 176 T 104 T 96 T 113 T 21 T 19 T 84 & T 85	1792 4000 4000 1825 1825C 1825	Contractor Provided Testing	Contractor Provided Testing	Contractor Quality Control Type D	Contractor Quality Control Type E	Project Manager Type D & E		
										A Sublot equals 1000 Mg or 1000 Tons	
										Review Documentation for Acceptance	
										Review Documentation for Acceptance	
Portland Cement Modifiers Admixtures	Materials must meet the requirements of Section 02001.10				Manufacture Compliance Statement		Review Documentation for Acceptance				
Drilling Slurry	Slurry material must meet the requirements of Section 00512.14 & 00512.43(g)				Contractor Provided Testing		Review Documentation for Acceptance				
Grout	Material must meet the requirements of Section 02080				Manufacture Compliance Statement		Review Documentation for Acceptance				
Mixing Water	Material must meet the requirements of Section 02020				Manufacture Compliance Statement		Review Documentation for Acceptance				

FIELD TESTED MATERIALS ACCEPTANCE GUIDE

(Revised November 2020)

Same Frequency for all Tests (Minimums)

MATERIAL AND OPERATION	DESCRIPTION OF TEST	TEST METHOD			FORM 734-	Quality Control		Quality Assurance
		ODOT	WAQTC	AASHTO		Contractor Quality Control Type D	Contractor Quality Control Type E	
SECTION 00512 - DRILLED SHAFTS (CONTINUED)								
Portland Cement Concrete	Sampling Slump Concrete Temperature Density (Unit Weight) Yield Water/Cement Ratio	TM 2	T 119 T 309 T 121 T 121 T 121		3573WS or 4000C	(M) (S) 1 per Shaft and Test at minimum frequencies according to table 00512-1. Review specs.	(M) (S) 1 per Shaft and Test at minimum frequencies according to table 00512-1. Review specs.	Review Documentation for Acceptance
						T 22 & T 23	4000C	
(S) 1 Set Represents a minimum of 3 Cylinders								
(M) Per Mix Design & Source								

TABLE 00512-1 Frequency of Quality Control Testing

Minimum frequencies per Class of concrete based on daily production records.	
Production	Frequencies
0 to 100 yd ³ on a single day	1 Set each day
Quantity Over 100 yd³	
100 to 600 yd ³ on a single day	1 Set per each 100 yd ³ or portion thereof
over 600 yd ³ on a single day	1 Set per each 200 yd ³ or portion thereof after reaching 600 yd ³

FIELD TESTED MATERIALS ACCEPTANCE GUIDE				(Revised November 2020)		Same Frequency for all Tests (Minimums)		
MATERIAL AND OPERATION	DESCRIPTION OF TEST	TEST METHOD			FORM	Quality Control		Quality Assurance
		ODOT	ASTM	AASHTO		Contractor Quality Control Type D	Contractor Quality Control Type E	
SECTION 00535 - POST-INSTALLED ANCHOR SYSTEMS								
Resin Bonded Anchor System								
Anchor Bolts, reinforcing steel and resin (Polyester, vinyl ester or epoxy)						A Sublot equals 50 Anchors		
<i>Materials must meet the requirements of Section 00535.10</i>								
Anchor Installation								
Demonstration Testing (See Section 00535.45(a))	Strength of Anchors in Concrete Elements		E 488		5189	One demonstration Test includes 3 anchors (Resin shall be from same lot)		Visual
Production Testing (See Section 00535.45(b))	Strength of Anchors in Concrete Elements		E 488		5189	^(A) 1 Anchor/Sublot or portion thereof (Minimum 1/Shift)		Visual per Sublot
^(A) Anchor testing is required per critical element identified in the Special Provisions or Plan Drawings.								

FIELD TESTED MATERIALS ACCEPTANCE GUIDE

(Revised November 2020)

Same Frequency for all Tests (Minimums)

MATERIAL AND OPERATION	DESCRIPTION OF TEST	TEST METHOD			FORM 734-	Quality Assurance		
		ODOT	ASTM	AASHTO		Contractor Quality Control Type D	Contractor Quality Control Type E	Project Manager Type D & E
SECTION 00535 - POST-INSTALLED ANCHOR SYSTEMS (continued)								
Mechanical Anchor System								
Mechanical Anchors						A Sublot equals 50 Anchors		
<i>Materials must meet the requirements of Section 00535.10(b)</i>								
Anchor Installation	Demonstration Testing (See Section 00535.45(a))	Strength of Anchors in Concrete Elements	E 488		5292	One demonstration Test includes 3 anchors		Visual
Production Testing (See Section 00535.45(b))	Strength of Anchors in Concrete Elements	E 488		5292	^(A) 1 Anchor/Sublot or portion thereof (Minimum 1/Shift)		Visual per Sublot	
^(A) Anchor testing is required per critical element identified in the Special Provisions or Plan Drawings.								

FIELD TESTED MATERIALS ACCEPTANCE GUIDE				(Revised November 2020)			Same Frequency for all Tests (Minimums)		
MATERIAL AND OPERATION	DESCRIPTION OF TEST	TEST METHOD			FORM 734-	Quality Control		Quality Assurance	
		ODOT	WAQTC	AASHTO		Contractor Quality Control Type D	Contractor Quality Control Type E		
SECTION 00540 - CONCRETE BRIDGES									
Aggregate Production									
(1) QAE may waive after 5 sublots/shifts	Sampling Reducing (2)(3)(4) Sieve Analysis (4) Fineness Modulus (1)(3) Wood Particles (4) Sand Equivalent	TM 225		R 90 R 76 T 27/T 11 T 27/T 11	1792	Contractor Provided Testing	Contractor Provided Testing	Review Documentation for Acceptance	Project Manager Type D & E
(2) Perform a minimum of 3 tests	(3) Coarse Aggregate (See Section 02690.20)	TM 208		T 104 T 96 T 113 T 21	4000	Minimum 1 per Project	Minimum 1 per Project		
Portland Cement Modifiers Admixtures	(3) Dry Rodded Unit Weight			T 19	1825 1825C	Contractor Provided Testing Minimum 1 per Project	Contractor Provided Testing Minimum 1 per Project		
Mixing Water	(3)(4) Bulk Specific Gravity & Absorption			T 84 & T 85	1825	Contractor Provided Testing Minimum 1 per Project	Contractor Provided Testing Minimum 1 per Project		Review Documentation for Acceptance
Materials must meet the requirements of Section 02001.10									
Material must meet the requirements of Section 02020									

FIELD TESTED MATERIALS ACCEPTANCE GUIDE				(Revised November 2020)		Same Frequency for all Tests (Minimums)		
MATERIAL AND OPERATION	DESCRIPTION OF TEST	TEST METHOD			FORM 734-	Quality Control		Quality Assurance
		ODOT	WAQTC	AASHTO		Contractor Quality Control Type D	Contractor Quality Control Type E	
SECTION 00540 - CONCRETE BRIDGES (CONTINUED)								
Portland Cement Concrete	Sampling Air Content Slump Concrete Temperature Density (Unit Weight) Yield Water/Cement Ratio Strength	TM 2	T 152 T 119 T 309 T 121 T 121 T 121	3573WS or 4000C	4000C	(M) (S) Test at minimum frequencies according to table 00540-1. Review specs.	(M) (S) Test at minimum frequencies according to table 00540-1. Review specs.	Review Documentation for Acceptance
<p>(S) 1 Set Represents a minimum of 3 Cylinders</p> <p>(M) Per Mix Design & Source</p>								
<p>TABLE 00540-1 Frequency of Quality Control Testing</p> <p>Minimum frequencies per Class of concrete based on daily production records.</p> <p>Production 0 to 100 yd³ on a single day 1 Set each day</p> <p>Quantity Over 100 yd³ 100 to 600 yd³ on a single day 1 Set per each 100 yd³ or portion thereof over 600 yd³ on a single day 1 Set per each 200 yd³ or portion thereof after reaching 600 yd³</p>								

FIELD TESTED MATERIALS ACCEPTANCE GUIDE				(Revised November 2020)		Same Frequency for all Tests (Minimums)		
MATERIAL AND OPERATION	DESCRIPTION OF TEST	TEST METHOD			FORM 734-	Quality Control		Quality Assurance
		ODOT	WAQTC	AASHTO		Contractor Quality Control Type D	Contractor Quality Control Type E	
SECTION 00556 - MULTI-LAYER POLYMER CONCRETE OVERLAY								
Aggregate Production								
	Moisture Content			T 255/265	1792	At time of mixing the polymer resin. See 00556.10-b.		
						Contractor Provided Testing	Contractor Provided Testing	Review Documentation for Acceptance
Polymer Resin						Material must meet the requirements of section 00556.10		Review Documentation for Acceptance

FIELD TESTED MATERIALS ACCEPTANCE GUIDE				(Revised November 2020)		Same Frequency for all Tests (Minimums)		
MATERIAL AND OPERATION	DESCRIPTION OF TEST	TEST METHOD		FORM 734-	Quality Control		Quality Assurance	
		ODOT	WAQTC		AASHTO	Contractor Quality Control Type D		Contractor Quality Control Type E
SECTION 00557 - PREMIXED POLYMER CONCRETE OVERLAYS								
Resin Primer								
Polyester Resin Binder Including (Initiator, Accelerators & Inhibitors)								
Aggregate Production								
Product Compliance								
(Submit 2- 50 lb. samples of blended aggregate (00557.02) during the trial overlay). See Section 00557.12(d)								
(1) Maybe required during Production								
Surface Texture Sand (see section 00557.12(e))								
Premixed Polymer Concrete								
(M) 1 set Represents a minimum of 3 (4"x8") cylinders cast per 00557.44(e).								
(2) Submit to ODOT - CML								
(B) Batch is defined "Per Mixer or Portion placed".								
Material must meet the requirements of section 00557.10					Contractor Provided Testing	Contractor Provided Testing	Review Documentation for Acceptance	
Material must meet the requirements of section 00557.12 (a-c)					Contractor Provided Testing	Contractor Provided Testing	Review Documentation for Acceptance	
Bulk Specific Gravity & Absorption		T 84 & T 85		4000	1/Project or Source	1/Project or Source	Review Documentation for Acceptance	
Moisture Content		T 255/265					Review Documentation for Acceptance	
Fracture (Method 1)		T 335					Review Documentation for Acceptance	
Moisture Content		T 255/265		1792	(1) During the Trial Overlay Strip	(1) During the Trial Overlay Strip	Review Documentation for Acceptance	
Sieve Analysis		T 27/11		1792	Contractor Provided Testing	Contractor Provided Testing	Review Documentation for Acceptance	
Density		T 121		3573WS	(B) 1/Batch	(B) 1/Batch	Review Documentation for Acceptance	
Modulus of Elasticity		TM 759		4000C	(M) Minimum 1 set/batch	(M) Minimum 1 set/batch	Review Documentation for Acceptance	
					(2) 1 set per 10 batches placed or minimum 1 set/day	(2) 1 set per 10 batches placed or minimum 1 set/day	Review Documentation for Acceptance	

FIELD TESTED MATERIALS ACCEPTANCE GUIDE				(Revised November 2020)		Same Frequency for all Tests (Minimums)		
MATERIAL AND OPERATION	DESCRIPTION OF TEST	TEST METHOD		FORM 734-	Quality Control		Quality Assurance	
		ODOT	WAQTC		AASHTO	Contractor Quality Control Type D		Contractor Quality Control Type E
SECTION 00559 - STRUCTURAL CONCRETE OVERLAYS								
Aggregate Production								
⁽¹⁾ QAE may waive after 5 sublots/shifts	Sampling Reducing	TM 229	R 90 R 76	T 27/T 11	1792	Contractor Provided Testing	Contractor Quality Control Type E	Review Documentation for Acceptance
⁽²⁾ Perform a minimum of 3 tests, QL's required	⁽⁴⁾ Sieve Analysis ⁽⁴⁾ Fineness Modulus ⁽⁴⁾ Sand Equivalent	TM 208	T 96 T 104 T 113 T 21	4000 4000	Minimum 1 Per Project	Minimum 1 Per Project	Review Documentation for Acceptance	
								⁽³⁾ Coarse Aggregate (See Section 02690.20)
⁽⁴⁾ Fine Aggregate (See Section 02690.30)	Abrasion Degradation Soundness Lightweight Pieces Organics	TM 208	T 19 T 84 & T 85	1825 1825C 1825	Start of production and when changes in aggregate occurs	Start of production and when changes in aggregate occurs	Review Documentation for Acceptance	
								Portland Cement Modifiers Admixtures
Mixing Water	Material must meet the requirements of Section 02020	Material must meet the requirements of Section 02020	Material must meet the requirements of Section 02020	Material must meet the requirements of Section 02020	Material must meet the requirements of Section 02020	Material must meet the requirements of Section 02020	Review Documentation for Acceptance	

FIELD TESTED MATERIALS ACCEPTANCE GUIDE				(Revised November 2020)				Same Frequency for all Tests (Minimums)																			
MATERIAL AND OPERATION	DESCRIPTION OF TEST	TEST METHOD			FORM 734-	Quality Control		Quality Assurance																			
		ODOT	WAQTC	AASHTO		Contractor Quality Control Type D	Contractor Quality Control Type E																				
SECTION 00559 - STRUCTURAL CONCRETE OVERLAYS (CONTINUED)																											
Portland Cement Concrete	Sampling Air Content Slump Concrete Temperature Density (Unit Weight) Yield W/C Ratio	TM 2	T 152 T 119 T 309 T 121 T 121 T 121	3573WS or 4000 C	A subplot equals 1 set of tests per 50 yd3	Contractor Quality Control Type D	Contractor Quality Control Type E	Project Manager Type D & E																			
									Latex Modified Concrete	Fine Aggregate Moisture	1792	Contractor Provided Testing	Contractor Provided Testing	Review Documentation for Acceptance													
															^(M) Per Mix Design & Source	Mixer Calibration	Contractor Provided Testing	Contractor Provided Testing	Review Documentation for Acceptance								
																				Strength	^(M) ^(S) 1 Set Cylinders per 50yd ³ Minimum 1 set/shift	^(M) ^(S) 1 Set Cylinders per 50yd ³ Minimum 1 set/shift	Review Documentation for Acceptance				
																								^(S) 1 Set Represents a minimum of 3 Cylinders	Contractor Provided Testing	Contractor Provided Testing	Review Documentation for Acceptance
Broadcast Aggregate	Moisture Content	1792	Field Test at time of Mixing Polymer Resin. See Section 00590.10-c	Field Test at time of Mixing Polymer Resin. See Section 00590.10-c	Review Documentation for Acceptance																						

FIELD TESTED MATERIALS ACCEPTANCE GUIDE					(Revised November 2020)			Same Frequency for all Tests (Minimums)		
MATERIAL AND OPERATION	DESCRIPTION OF TEST	TEST METHOD			FORM 734-	Quality Control		Quality Assurance		
		ODOT	WAQTC	AASHTO		Contractor Quality Control Type D	Contractor Quality Control Type E			
SECTION 00596A - MECHANICALLY STABILIZED EARTH RETAINING WALLS										
Aggregate Production										
Gravel Leveling Pads Backfill (See Section 02630.10)										
	Abrasion Degradation	TM 208		T96	4000	Contractor Provided Testing	Minimum 1 Per Project	Review Documentation for Acceptance		
	Sampling Reducing Sieve Analysis Sand Equivalent			R 90 R 76 T 27 T 176	1792	1/Sublot	Visual	Review Documentation for Acceptance		
	Fracture (Method 1)			T 335	1792	1/5 Sublots				
					A Sublot equals 1,000 Tons Minimum 1/Project					
					Testing Frequency for Product Compliance per Source 1/5,000 Tons Minimum 1/Project					
⁽³⁾ Modular Block Core and Drainage Backfill (Product Compliance)	Soundness Abrasion Degradation Lightweight Pieces	TM 208		T 104 T 96 T 113	4000 4000	Contractor Provided Testing	Minimum 1 Per Project	Review Documentation for Acceptance		
⁽³⁾ (See Section 2690.20(a) thru 2690.20(d) & 2690.20(f)					A Sublot equals 1,000 Tons					
⁽³⁾ Modular Block Core and Drainage Backfill ⁽¹⁾ QAE may waive after 5 sublots/shifts	Sampling Reducing ⁽²⁾ Sieve Analysis ⁽¹⁾ Wood Particles Fracture (Method 2) Elongated Pieces	TM 225 TM 229		R 90 R 76 T 27/T 11 T 335	1792 1792	1/Sublot or Minimum 1 Per Project	Visual	Review Documentation for Acceptance		
⁽²⁾ Perform a minimum of 3 tests, QL's required										
Pipe Drain Backfill (Product Compliance) (See Section 00430.11)	Abrasion Degradation Sieve Analysis	TM 208		T 96 T27	4000 4000	Contractor Provided Testing 1/Sublot	Minimum 1 Per Project Visual	Review Documentation for Acceptance		

FIELD TESTED MATERIALS ACCEPTANCE GUIDE					(Revised November 2020)			Same Frequency for all Tests (Minimums)					
MATERIAL AND OPERATION	DESCRIPTION OF TEST	TEST METHOD			FORM 734-	Quality Control		Quality Assurance					
		ODOT	WAQTC	AASHTO		Contractor Quality Control Type D	Contractor Quality Control Type E	Project Manager Type D & E	Project Manager Type D & E				
SECTION 00596A - MECHANICALLY STABILIZED EARTH RETAINING WALLS													
Aggregate Production													
Gabion Basket Fill (Product Compliance) (See Section 00390.11(b))	Degradation Soundness Apparent Specific Gravity & Absorption Gradation	TM 208		T 104 T 85	4000	Contractor Provided Testing	Minimum 1 per Project	Review Documentation for Acceptance					
											1/5000 Tons Minimum 1/Project	1/Sublot (Minimum 1/Project)	Visual

FIELD TESTED MATERIALS ACCEPTANCE GUIDE				(Revised November 2020)		Same Frequency for all Tests (Minimums)										
MATERIAL AND OPERATION	DESCRIPTION OF TEST	TEST METHOD		FORM 734-	Quality Control		Quality Assurance									
		ODOT	WAQTC		AASHTO	Contractor Quality Control Type D		Contractor Quality Control Type E	Project Manager Type D & E							
SECTION 00596A - MSE RETAINING WALLS																
Aggregate Production																
MSE Granular Wall Backfill (Product Compliance) (Also reference 02630. 10)	Abrasion Degradation Sieve Analysis Plasticity Index pH Resistivity Organic Content	TM 208		T 96 T 11 T 90 T 289 T 288 T 267	4000	Contractor Provided Testing	Minimum 1 per Project	Review Documentation for Acceptance								
					4000											
					Testing Frequency for Product Compliance per Source 1/5000 Tons Minimum 1/Project											
					A Sublot Equals or 2000 Tons											
					Review Documentation for Acceptance											
MSE Granular Wall Backfill (¹) Perform a minimum of 3 tests, QL's required	Sampling Reducing (¹) Sieve Analysis Sand Equivalent			R 90 R 76 T 27 T 176	1792	1/Sublot (Minimum 1/Project)	Visual	Review Documentation for Acceptance								
					1792											
					1792											
					1792											
Placement Establishing Maximum Density (²) Method A	Density Curve Bulk Specific Gravity Coarse Particle Correction	TM 223		(2) T 99 T 85	3468	1/Aggregate Gradation/Per Source	Visual	Review Documentation for Acceptance								
					3468											
					1793B											
					1793B											
Compaction	Nuclear Gauge Deflection Testing	TM 158		T 310	1793B	1/100 yd ³ (Minimum 1/day)	Visual	Review Documentation for Acceptance								
					1793B											
<p style="text-align: center;">Contractor must demonstrate, by compaction testing or acceptable visual means, that the material, equipment, and process used for compaction achieves the specification requirements. If the material, equipment, or process changes, or if other conditions indicate a non-specification product, the Contractor must re-demonstrate that specification requirements are being achieved.</p>																

FIELD TESTED MATERIALS ACCEPTANCE GUIDE				(Revised November 2020)				Same Frequency for all Tests (Minimums)			
MATERIAL AND OPERATION	DESCRIPTION OF TEST	TEST METHOD		FORM 734-734-	Quality Control		Quality Assurance				
		ODOT	WAQTC		AASHTO	Contractor Quality Control Type D		Contractor Quality Control Type E			
SECTION 00596B - PREFABRICATED MODULAR RETAINING WALLS											
Aggregate Production											
Gravel Leveling Pads Backfill (See Section 02630.10)	Abrasion Degradation	TM 208	T96	4000	Contractor Provided Testing	Minimum 1 Per Project	Review Documentation for Acceptance				
				A Sublot equals 1000 Tons Minimum 1/Project							
				1792	1/Sublot	Visual	Review Documentation for Acceptance				
				1792	1/5 Sublots	Visual					
Soundness											
⁽³⁾ Modular Block Core and Drainage Backfill (Product Compliance)	Abrasion Degradation Lightweight Pieces	TM 208	T 104 T 96 T 113	4000	Contractor Provided Testing	Minimum 1 Per Project	Review Documentation for Acceptance				
				Testing Frequency for Product Compliance per Source 1/5000 Tons Minimum 1/Project							
				4000							
Sampling Reducing											
⁽³⁾ Modular Block Core and Drainage Backfill ⁽¹⁾ QAE may waive after 5 sublots/shifts	⁽²⁾ Sieve Analysis ⁽¹⁾ Wood Particles Fracture (Method 2) Elongated Pieces	TM 225 TM 229	R 90 R 76 T 27/T 11 T 335	1792	1/Sublot (Minimum 1 Per Project)	Visual	Review Documentation for Acceptance				
				A Sublot equals 1000 Tons							
				1792							
Performance											
Pipe Drain Backfill (Product Compliance) (See Section 00430.11)	Abrasion Degradation	TM 208	T 96	4000	Contractor Provided Testing	Minimum 1 Per Project	Review Documentation for Acceptance				
				4000	1/Sublot	Visual					

FIELD TESTED MATERIALS ACCEPTANCE GUIDE				(Revised November 2020)		Same Frequency for all Tests (Minimums)		
MATERIAL AND OPERATION	DESCRIPTION OF TEST	TEST METHOD		FORM 734-	Quality Control		Quality Assurance	
		ODOT	WAQTC		AASHTO	Contractor Quality Control Type D		Contractor Quality Control Type E
SECTION 00596B - PREFABRICATED MODULAR RETAINING WALLS								
Aggregate Production								
Gabion Basket Fill (Product Compliance) (See Section 00390.11(b))	Degradation Soundness Apparent Specific Gravity & Absorption Gradation	TM 208		T 104 T 85	4000	Contractor Provided Testing	Minimum 1 Per Project	Review Documentation for Acceptance
					1825	1/Sublot	Visual	
Testing Frequency for Product Compliance per Source 1/5000 Tons Minimum 1/Project								

FIELD TESTED MATERIALS ACCEPTANCE GUIDE				(Revised November 2020)		Same Frequency for all Tests (Minimums)		
MATERIAL AND OPERATION	DESCRIPTION OF TEST	TEST METHOD		FORM 734-734-	Quality Control		Quality Assurance	
		ODOT	WAQTC		AASHTO	Contractor Quality Control Type D		Contractor Quality Control Type E
SECTION 00596B - PREFABRICATED MODULAR RETAINING WALLS								
Aggregate Production								
Retaining Wall Granular Backfill (Product Compliance) (Also reference 02630.10)	Abrasion						Testing Frequency for Product Compliance per Source 1/5000 Tons Minimum 1/Project	
	Degradation	TM 208		T96	4000	Contractor Provided Testing	Minimum 1 Per Project	Review Documentation for Acceptance
	Sieve Analysis			T 11	4000			
	Plasticity Index			T 90				
Retaining Wall Granular Backfill								
(1) Perform a minimum of 3 tests, QL's required	Sampling Reducing			R 90			A Sublot Equals 2000 Tons	
	(1) Sieve Analysis Sand Equivalent			R 76	1792	1/Sublot (Min. 1 Per Project)	Visual	Review Documentation for Acceptance
				T 27				
	Fracture (Method 1)			T 176	1792	1/5 Sublots	Visual	
Placement								
Establishing Maximum Density	Density Curve			(2) T 99	3468	1/Aggregate Gradation/Per Source	Visual	Review Documentation for Acceptance
	Bulk Specific Gravity			T 85	3468			
(2) Method A	Coarse Particle Correction	TM 223		T 310	1793B	1/100 yd ³ (Minimum 1/day)	Visual	
	Nuclear Gauge				1793B	1 per layer	Visual	
	Deflection Testing	TM 158						
<p>Contractor must demonstrate, by compaction testing or acceptable visual means, that the material, equipment, and process used for compaction achieves the specification requirements. If the material, equipment, or process changes, or if other conditions indicate a non-specification product, the Contractor must re-demonstrate that specification requirements are being achieved.</p>								

FIELD TESTED MATERIALS ACCEPTANCE GUIDE					(Revised November 2020)			Same Frequency for all Tests (Minimums)							
MATERIAL AND OPERATION	DESCRIPTION OF TEST	TEST METHOD			FORM 734-	Quality Control		Quality Assurance							
		ODOT	WAQTC	AASHTO		Contractor Quality Control Type D	Contractor Quality Control Type E								
SECTION 00596C - CAST-IN-PLACE CONCRETE RETAINING WALLS															
Aggregate Production															
Pipe Drain Backfill (Product Compliance) (See Section 00430.11)	Abrasion Degradation	TM 208	T 96	4000	Contractor Provided Testing	Minimum 1 Per Project	Review Documentation for Acceptance								
											Sieve Analysis	T27	4000	1/Sublot	Visual
Retaining Wall Granular Backfill					Testing Frequency for Product Compliance per Source 1/5000 Tons Minimum 1/Project										
Retaining Wall Granular Backfill (Product Compliance) (Also reference 02630.10)	Abrasion Degradation Sieve Analysis Plasticity Index	TM 208	T 96 T 11 T 90	4000 4000	Contractor Provided Testing	Minimum 1 Per Project	Review Documentation for Acceptance								
											Sampling Reducing (¹) Sieve Analysis	R 90 R 76 T 27	1792	1/Sublot	Visual
Retaining Wall Granular Backfill (¹) Perform a minimum of 3 tests, QL's required					A Sublot Equals 2000 Tons										

FIELD TESTED MATERIALS ACCEPTANCE GUIDE				(Revised November 2020)		Same Frequency for all Tests (Minimums)		
MATERIAL AND OPERATION	DESCRIPTION OF TEST	TEST METHOD			FORM 734-	Quality Control		Quality Assurance
		ODOT	WAQTC	AASHTO		Contractor Quality Control Type D	Contractor Quality Control Type E	
SECTION 00596C - CAST-IN-PLACE CONCRETE RETAINING WALLS								
Placement								
Retaining Wall Granular Backfill								
Establishing Maximum Density (¹) Method A	Density Curve			(¹) T 99	3468			Review Documentation for Acceptance
	Bulk Specific Gravity			T 85	3468	1/Aggregate Gradation/Per Source	Visual	
Compaction	Coarse Particle Correction		TM 223					Review Documentation for Acceptance
	Nuclear Gauge			T 310	1793B	1/100 yd ³ (Minimum 1/day)	Visual	
	Deflection Testing		TM 158		1793B	1 per layer	Visual	
<p>Contractor must demonstrate, by compaction testing or acceptable visual means, that the material, equipment, and process used for compaction achieves the specification requirements. If the material, equipment, or process changes, or if other conditions indicate a non-specification product, the Contractor must re-demonstrate that specification requirements are being achieved.</p>								

FIELD TESTED MATERIALS ACCEPTANCE GUIDE				(Revised November 2020)		Same Frequency for all Tests (Minimums)			
MATERIAL AND OPERATION	DESCRIPTION OF TEST	TEST METHOD			FORM 734-	Quality Control			
		ODOT	WAQTC	AASHTO		Contractor Quality Control Type D	Contractor Quality Control Type E	Quality Assurance	
SECTION 00635 - GRID-ROLLED AGGREGATE SUBBASE									
Aggregate Subbase Grading (See 00635.10)	Abrasion			T 96	4000	Contractor Provided Testing		Requires Signed and Notarized Statement of Compliance For All Items Under Section 00600	Review Documentation for Acceptance
	Sampling Reducing Sieve Analysis Sand Equivalent			R 90 R 76 T 27 T 176	1792	Contractor Provided Testing			Review Documentation for Acceptance

FIELD TESTED MATERIALS ACCEPTANCE GUIDE				(Revised November 2020)				Same Frequency for all Tests (Minimums)					
MATERIAL AND OPERATION	DESCRIPTION OF TEST	TEST METHOD		FORM 734-	Quality Control		Quality Assurance						
		ODOT	WAQTC		AASHTO	Contractor Quality Control Type D		Contractor Quality Control Type E	Project Manager Type D & E				
SECTION 00641 - AGGREGATE SUBBASE, BASE, AND SHOULDERS													
Aggregate Production	Abrasion					T 96	4000	Contractor Provided Testing	Submit Required Documentation		Review Documentation for Acceptance		
Aggregate Subbase Grading (See 00641.10(b))	Sampling Reducing Sieve Analysis Sand Equivalent					R 90 R 76 T 27 T 176	1792	Contractor Provided Testing	Submit Required Documentation		Review Documentation for Acceptance		
Aggregate Base and Shoulders	Abrasion Degradation	TM 208					4000	Minimum 1 per Project	Submit Required Documentation		Review Documentation for Acceptance		
Grading							A Sublot equals 2000 Tons						
Aggregate Base (See 02630)	Sampling Reducing					R 90 R 76 T 27 T 176		Contractor Provided Testing	Submit Required Documentation		Review Documentation for Acceptance		
Aggregate Shoulder (See 02640)							1792						
Open Graded Aggregate Base (See 02630.11)	(1) Sieve Analysis (2) Sand Equivalent							Contractor Provided Testing			Review Documentation for Acceptance		
	(1) Perform at least 3 tests (2) May be waived by QAE					T 335	1792						
PLACEMENT													
Aggregate Base Plant Mix Applications Only Aggregate (Mixture)	Sampling Reducing Moisture					R 90 R 76 T 255 & T 265 (3) T 99		1/Sublot or minimum 1 per day	Visual		Review Documentation for Acceptance		
Establishing Maximum Density & Optimum Moisture (Mix Design)	Density Curve Coarse Particle Correction Bulk Specific Gravity	TM 223					3468	Each Size Per Source	Visual		Review Documentation for Acceptance		
Compaction (3) Method A						T 85			Visual		Review Documentation for Acceptance		
(D) (Individual tests must meet Specification)	Deflection Testing Nuclear Gauge	TM 158				T 310	1793B	1 per Sublot	Visual		Review Documentation for Acceptance		
							1793B	(D) 5 Tests Per Sublot	Visual		Review Documentation for Acceptance		

FIELD TESTED MATERIALS ACCEPTANCE GUIDE				(Revised November 2020)				Same Frequency for all Tests (Minimums)			
MATERIAL AND OPERATION	DESCRIPTION OF TEST	TEST METHOD			FORM	Quality Control		Quality Assurance			
		ODOT	WAQTC	AASHTO		Contractor Quality Control Type D	Contractor Quality Control Type E				
SECTION 00641 - AGGREGATE SUBBASE, BASE, AND SHOULDERS (Continued)											
Placement											
Aggregate Subbase											
Compaction	Deflection Testing	TM 158			1793 B	1 per Layer	Visual				Review Documentation for Acceptance

FIELD TESTED MATERIALS ACCEPTANCE GUIDE				(Revised November 2020)		Same Frequency for all Tests (Minimums)							
MATERIAL AND OPERATION	DESCRIPTION OF TEST	TEST METHOD		FORM 734-	Quality Control		Quality Assurance						
		ODOT	WAQTC		AASHTO	Contractor Quality Control Type D	Contractor Quality Control Type E	Project Manager Type D & E					
SECTION 00680 - STOCKPILED AGGREGATES													
Aggregate Base and Shoulders (See Section 00641)	Abrasion Degradation	TM 208		T 96	4000	Minimum 1 per Source/Project	Visual	Review Documentation for Acceptance					
					A Sublot equals 2,000 Tons								
					1792	Contractor Provided Testing	Visual	Review Documentation for Acceptance					
					1792	1/5 Sublots	Visual						
Aggregate (Sanding Aggregate)	Sampling Reducing Sieve Analysis (3) Cleaness Value	TM 227		R 90 R 76 T 27	1792	Contractor Provided Testing	Visual	Review Documentation for Acceptance					
					A Sublot equals 1000 Tons								
					4000	Minimum 1 per Source/Project	Visual						
					4000	1/5 Sublots & Start of Production	Visual	Review Documentation for Acceptance					
(3) May be waived by QAE	Abrasion Degradation Lightweight Pieces	TM 208		T 96 T 113	4000	Minimum 1 per Source/Project	Visual						
					1792	1/5 Sublots & Start of Production	Visual	Review Documentation for Acceptance					
					1792								
					1792								

FIELD TESTED MATERIALS ACCEPTANCE GUIDE				(Revised November 2020)		Same Frequency for all Tests (Minimums)											
MATERIAL AND OPERATION	DESCRIPTION OF TEST	TEST METHOD			FORM 734-	Quality Control		Quality Assurance									
		ODOT	WAQTC	AASHTO		Contractor Quality Control Type D	Contractor Quality Control Type E		Project Manager Type D & E								
SECTION 00680 - STOCKPILED AGGREGATES (CONTINUED)																	
Emulsified AC Aggregate Aggregate Production (See Sections 00705, 00706, 00710, 00711, 00712 and 00715) (1) QAE may waive after 5 sublots/shifts (2) QAE may waive wet sieve after 5 sublots/shifts if a correlation to dry sieve can be demonstrated (3) May be waived by QAE (4) Not required for Dry Key Material (5) 1/5 Sublots & Start of Production	Abrasion Degradation Soundness Lightweight Pieces Dry Rodded Unit Weight Sampling Reducing (5) Fracture (1) Wood Particles (1)(4) Elongated Pieces (2) Sieve Analysis (3) Cleanness Value Dry Rodded Unit Weight	TM 208 TM 225 TM 229 TM 227	T 96 T 104 T 113 T 19 R 90 R 76 T 335 T27/T 11 T 19	4000 4000 1792 1792 1825 1825C	A sublot equals 500 Tons. A minimum 1 per shift, whichever results in the greatest sampling frequency	Minimum 1 per Source/Project Contractor Provided Testing	Visual Visual	Review Documentation for Acceptance									
									Aggregate (Other)								
									<i>Use sampling and testing frequencies required for proposed end product use</i>								

FIELD TESTED MATERIALS ACCEPTANCE GUIDE				(Revised November 2020)		Same Frequency for all Tests (Minimums)				
MATERIAL AND OPERATION	DESCRIPTION OF TEST	TEST METHOD			FORM 734-	Quality Control		Quality Assurance		
		ODOT	WAQTC	AASHTO		Contractor Quality Control Type D	Contractor Quality Control Type E			
SECTION 00705 - ASPHALT PRIME COAT and EMULSIFIED ASPHALT FOG COAT										
Aggregate Production Aggregate Cover Material	Sampling Reducing Sieve Analysis			R 90 R 76 T 27	1792	Provide Process Control	Requires Signed and Notarized Statement of Compliance From Contractor For All Items Under Section 00700	Review Documentation for Acceptance		
Asphalt Prime and Fog Coat Asphalt Cement (Emulsion)	Compliance			R 66	4000	Provide Suppliers Certificate of Compliance		Review Documentation for Acceptance		
SECTION 00706 - EMULSIFIED ASPHALT SLURRY SEAL SURFACING										
Aggregate Production	Sampling Reducing Sieve Analysis			R 90 R 76 T 27/T 11	1792	Provide Process Control	Visual	Review Documentation for Acceptance		
Emulsified Asphalt Cement Emulsified Asphalt Polymer Modified Emulsion	Compliance				4000	Provide Suppliers Certificate of Compliance	Visual	Review Documentation for Acceptance		
Additives Mineral Filler							Visual	Review Documentation for Acceptance		
Mixture							Visual	Review Documentation for Acceptance		

FIELD TESTED MATERIALS ACCEPTANCE GUIDE				(Revised November 2020)		Same Frequency for all Tests (Minimums)				
MATERIAL AND OPERATION	DESCRIPTION OF TEST	TEST METHOD			FORM 734-	Quality Control		Quality Assurance		
		ODOT	WAQTC	AASHTO		Contractor Quality Control Type D	Contractor Quality Control Type E	Contractor Quality Control Type D & E	Project Manager Type D & E	
SECTION 00710 - SINGLE APPLICATION EMULSIFIED ASPHALT SURFACE TREATMENT										
Aggregate Production										
(1) QAE may waive after 5 sublots/shifts (2) Perform at least 3 tests (QL's required), QAE may waive wet sieve after 5 sublots/shifts if a correlation to dry sieve can be demonstrated (3) May be waived by QAE (4) Not required for Dry Key Material (5) 1/5 Sublots & Start of Production	Abrasion Degradation Soundness Lightweight Pieces Dry Rodded Unit Weight	TM 208	T 96 T 104 T 113 T 19	4000	Contractor Provided Testing	Contractor Provided Testing Minimum 1 per Project	Review Documentation for Acceptance			
	Sampling Reducing (5) Fracture (1) Wood Particles (1)(4) Elongated Pieces	TM 225 TM 229	R 90 R 76 T 335	1792	1 per Sublot	Visual	Review Documentation for Acceptance			
	(2) Sieve Analysis (3) Cleaness Value Dry Rodded Unit Weight	TM 227	T27/T 11 T 19	1792	Start of production and when changes in aggregate occurs	Visual	Review Documentation for Acceptance			
	Asphalt Cement (Emulsion)	Compliance		R 66	1825 1825C	Provide Suppliers Certificate of Compliance	Provide Suppliers Certificate of Compliance	Review Documentation for Acceptance		
					4000	Provide Suppliers Certificate of Compliance	Provide Suppliers Certificate of Compliance	Review Documentation for Acceptance		
Preproduced Aggregate										
Compliance of aggregates produced and stockpiled before the award date or notice to proceed of this contract will be determined by the following: 1. Continuing production records meeting the above requirements of Section 00710.10 and 710.15, Aggregate Production. 2. Furnish records of testing for the entire stockpile according to Section 00710.10 and 710.15 Aggregate Production except change the sampling frequency to the following: a. One Per 5 sublots means "One Set of Tests Per 2500 Tons". b. One Per sublot means "One Set of Tests Per 500 Tons" with a minimum of 3 sets of Sieve Analysis tests per project. c. Provide one stockpile sample for each set of tests required above.										

FIELD TESTED MATERIALS ACCEPTANCE GUIDE				(Revised November 2020)		Same Frequency for all Tests (Minimums)		
MATERIAL AND OPERATION	DESCRIPTION OF TEST	TEST METHOD		FORM 734-	Quality Control			
		ODOT	WAQTC		AASHTO	Contractor Quality Control Type D	Contractor Quality Control Type E	Project Manager Type D & E
SECTION 00711 - PRE-COATED AGGREGATE ASPHALT SURFACE TREATMENT								
Aggregate Production								
(1) QAE may waive after 5 sublots/shifts (2) Perform at least 3 tests (QL's required), QAE may waive wet sieve after 5 sublots/shifts if a correlation to dry sieve can be demonstrated	Abrasion Degradation Soundness Lightweight Pieces Dry Rodded Unit Weight	TM 208		T 96 T 104 T 113 T 19	4000	Contractor Provided Testing	Contractor Quality Control Type E	Review Documentation for Acceptance
(3) May be waived by QAE	Sampling Reducing (5) Fracture (1) Wood Particles (1)(4) Elongated Pieces	TM 225 TM 229		R 90 R 76 T 335	1792	1 per Sublot	Visual	Review Documentation for Acceptance
(4) Not required for Dry Key Material (5) 1/5 Sublots & Start of Production	(2) Sieve Analysis (3) Cleaness Value Dry Rodded Unit Weight	TM 227		T 27/T 11 T 19	1792	Start of production and when changes in aggregate occurs	Visual	Review Documentation for Acceptance
Asphalt Cement (Emulsion)	Compliance			R 66	4000	Provide Suppliers Certificate of Compliance	Provide Suppliers Certificate of Compliance	Review Documentation for Acceptance
Preproduced Aggregate								
Compliance of aggregates produced and stockpiled before the award date or notice to proceed of this contract will be determined by the following:								
1. Continuing production records meeting the above requirements of Section 00711.10 and 711.15, Aggregate Production. 2. Furnish records of testing for the entire stockpile according to Section 00711.10 and 711.15 Aggregate Production except change the sampling frequency to the following: <ol style="list-style-type: none"> One Per 5 sublots means "One Set of Tests Per 2500 Tons". One Per sublot means "One Set of Tests Per 500 Tons" with a minimum of 3 sets of Sieve Analysis tests per project. Provide one stockpile sample for each set of tests required above. 								

FIELD TESTED MATERIALS ACCEPTANCE GUIDE				(Revised November 2020)				Same Frequency for all Tests (Minimums)			
MATERIAL AND OPERATION	DESCRIPTION OF TEST	TEST METHOD		FORM 734-	Quality Control		Quality Assurance				
		ODOT	WAQTC		AASHTO	Contractor Quality Control Type D		Contractor Quality Control Type E	Project Manager Type D & E		
SECTION 00711 - PRE-COATED AGGREGATE ASPHALT SURFACE TREATMENT (CONTINUED)											
Mixture Acceptance											
Meter Method	Readings backed by Tank Measure & Production Records Daily	TM 321 (1) TM 322			2277	1/Sublot or Min. 1/Day	Production Control Testing	Review Documentation for Acceptance			
⁽¹⁾ Required at start of production and if meters fail to meet specification	Cold Feed Moisture		T 255/265		2043 and 2401	Daily Production	Production Control Testing				
Plant Discharge Moisture	Asphalt Mix Moist.		T 329		2277	1/Sublot or Min. 1/Day	Production Control Testing				
Asphalt Cement	Compliance		R 66		4000	1/50 Tons Submit All	Provide Suppliers Certificate of Compliance	Review Documentation for Acceptance			
A sublot equals 500 Tons. A minimum 1 per shift, whichever results in the greatest sampling frequency											

FIELD TESTED MATERIALS ACCEPTANCE GUIDE				(Revised November 2020)		Same Frequency for all Tests (Minimums)		
MATERIAL AND OPERATION	DESCRIPTION OF TEST	TEST METHOD			FORM 734-	Quality Control		Quality Assurance
		ODOT	WAQTC	AASHTO		Contractor Quality Control Type D	Contractor Quality Control Type E	
SECTION 00712 - DRY KEY EMULSIFIED ASPHALT SURFACE TREATMENT								
Aggregate Production								
Aggregate Production ⁽¹⁾ QAE may waive after 5 sublots/shifts ⁽²⁾ Perform at least 3 tests (QL's required), QAE may waive wet sieve after 5 sublots/shifts if a correlation to dry sieve can be demonstrated ⁽³⁾ May be waived by QAE ⁽⁴⁾ Not required for Dry Key Material ⁽⁵⁾ 1/5 Sublots & Start of Production Asphalt Cement (Emulsion)	Abrasion	TM 208	T 96	4000	A sublot equals 500 Tons. A minimum 1 per shift, whichever results in the greatest sampling frequency	Contractor Provided Testing	Contractor Provided Testing Minimum 1 per Project	Review Documentation for Acceptance
	Degradation		T 104					
	Soundness		T 113					
	Lightweight Pieces		T 19	4000				
	Dry Rodded Unit Weight							
	Sampling		R 90					
	Reducing		R 76					
	⁽⁵⁾ Fracture		T 335	1792				
	⁽¹⁾ Wood Particles	TM 225						
	⁽¹⁾⁽⁴⁾ Elongated Pieces	TM 229						
⁽²⁾ Sieve Analysis		T 27/T 11	1792	Review Documentation for Acceptance				
⁽³⁾ Cleaness Value	TM 227							
Dry Rodded Unit Weight					1 per Sublot	Visual		
Asphalt Cement (Emulsion)	Compliance		1825	Start of production and when changes in aggregate occurs	Provide Suppliers Certificate of Compliance	Provide Suppliers Certificate of Compliance	Review Documentation for Acceptance	
			1825C					
			4000	R 66	Provide Suppliers Certificate of Compliance			

Preproduced Aggregate

Compliance of aggregates produced and stockpiled before the award date or notice to proceed of this contract will be determined by the following:

- Continuing production records meeting the above requirements of Section 00712.10 and 712.15, Aggregate Production.
- Furnish records of testing for the entire stockpile according to Section 00712.10 and 712.15 Aggregate Production except change the sampling frequency to the following:
 - One Per 5 sublots means "One Set of Tests Per 2500 Tons".
 - One Per sublot means "One Set of Tests Per 500 Tons" with a minimum of 3 sets of Sieve Analysis tests per project.
 - Provide one stockpile sample for each set of tests required above.

FIELD TESTED MATERIALS ACCEPTANCE GUIDE				(Revised November 2020)		Same Frequency for all Tests (Minimums)		
MATERIAL AND OPERATION	DESCRIPTION OF TEST	TEST METHOD		FORM 734-	Quality Control			
		ODOT	WAQTC		AASHTO	Contractor Quality Control Type D	Contractor Quality Control Type E	Project Manager Type D & E
SECTION 00715 - MULTIPLE APPLICATION EMULSIFIED ASPHALT SURFACE TREATMENT								
Aggregate Production								
(1) QAE may waive after 5 sublots/shifts (2) Perform at least 3 tests (QL's required), QAE may waive wet sieve after 5 sublots/shifts if a correlation to dry sieve can be demonstrated	Abrasion Degradation Soundness Lightweight Pieces Dry Rodded Unit Weight	TM 208		T 96 T 104 T 113 T 19	4000	Contractor Provided Testing	Contractor Provided Testing Minimum 1 per Project	Review Documentation for Acceptance
(3) May be waived by QAE (4) Not required for Dry Key Material (5) 1/5 Sublots & Start of Production	Sampling Reducing (5) Fracture (1) Wood Particles (1)(4) Elongated Pieces	TM 225 TM 229		R 90 R 76 T 335	1792	1 per Sublot	Visual	Review Documentation for Acceptance
Asphalt Cement (Emulsion)	Compliance	TM 227		T27/T 11 T 19	1792 1825 1825C	Start of production and when changes in aggregate occurs	Visual	Review Documentation for Acceptance
Preproduced Aggregate								
Compliance of aggregates produced and stockpiled before the award date or notice to proceed of this contract will be determined by the following:								
1. Continuing production records meeting the above requirements of Section 00715.10 and 715.15, Aggregate Production. 2. Furnish records of testing for the entire stockpile according to Section 00715.10 and 715.15 Aggregate Production except change the sampling frequency to the following: <ul style="list-style-type: none"> a. One Per 5 sublots means "One Set of Tests Per 2500 Tons". b. One Per sublot means "One Set of Tests Per 500 Tons" with a minimum of 3 sets of Sieve Analysis tests per project. c. Provide one stockpile sample for each set of tests required above. 								

FIELD TESTED MATERIALS ACCEPTANCE GUIDE				(Revised November 2020)		Same Frequency for all Tests (Minimums)							
MATERIAL AND OPERATION	DESCRIPTION OF TEST	TEST METHOD		FORM 734-	Quality Control		Quality Assurance						
		ODOT	WAQTC		AASHTO	Contractor Quality Control Type D	Contractor Quality Control Type E	Project Manager Type D & E					
SECTION 00720 - COLD IN-PLACE RECYCLED ASPHALT CONCRETE PAVEMENT (CIR)													
SECTION 00721 - COLD RECYCLED EMULSIFIED ASPHALT CONCRETE PAVEMENT (CRP)													
Asphalt Cement (Emulsified Recycling Agent)	Compliance	R 66	4000	Provide Suppliers Certificate of Compliance	Provide Suppliers Certificate of Compliance	Provide Suppliers Certificate of Compliance	Review Documentation for Acceptance						
Water		Material must meet the requirements of Section 00340.10				Visual	Review Documentation for Acceptance						
Aggregate Production Choke Aggregate (See 00705)	Sampling Reducing Sieve Analysis	R 90 R 76 T 27	1792	Provide Process Control	Visual	Review Documentation for Acceptance							
										A Sublot equals 1000 Tons			
SECTION 00725 - HOT IN-PLACE RECYCLED (HIR) ASPHALT CONCRETE PAVEMENT													
<i>The type of recycling agent will be listed in the Special Provisions</i>													
Recycling Agent (See 00745.11)	Compliance	R 66	4000	Provide Suppliers Certificate of Compliance	Provide Suppliers Certificate of Compliance	Review Documentation for Acceptance							
Recycling Agent	Compliance	R 66	4000	Provide Suppliers Certificate of Compliance	Provide Suppliers Certificate of Compliance	Review Documentation for Acceptance							
Asphalt Concrete Mixture	New Asphalt Concrete mixture will meet the requirements of Section 00744												
SECTION 00730 - ASPHALT TACK COAT													
Tack	Compliance	R 66	4000	Provide Suppliers Certificate of Compliance	Provide Suppliers Certificate of Compliance	Review Documentation for Acceptance							

FIELD TESTED MATERIALS ACCEPTANCE GUIDE				(Revised November 2020)		Same Frequency for all Tests (Minimums)			
MATERIAL AND OPERATION	DESCRIPTION OF TEST	TEST METHOD			FORM 734-	Quality Control		Quality Assurance	
		ODOT	WAQTC	AASHTO		Contractor Quality Control Type D	Contractor Quality Control Type E	Contractor Quality Control Type D & E	Project Manager Type D & E
SECTION 00735 - EMULSIFIED ASPHALT CONCRETE PAVEMENT									
Aggregate production									
(1) May be waived by QAE (2) QAE may waive after 5 sublots/shifts	Abrasion Degradation Soundness Lightweight Pieces	TM 208		T 96 T 104 T 113	4000	Contractor Provided Testing Minimum 1 per Project	Contractor Provided Testing Minimum 1 per Project	Review Documentation for Acceptance	
					4000				
					A Sublot equals 1000 Tons. A minimum one per shift, whichever results in the greatest sampling frequency. (For preproduced aggregates, 1 shift shall mean 1000 Tons)				
Choke Aggregate	Sampling Reducing Sieve Analysis (1) Cleanness Value Fracture (2) Elongated Pieces (2) Wood Particles Sieve Analysis	TM 227 TM 229 TM 225		R 90 R 76 T 27/T 11 T 335 T 27	1792	1/Sublot & Start of Production	Visual	Review Documentation for Acceptance	
					1792				
					1792				

FIELD TESTED MATERIALS ACCEPTANCE GUIDE				(Revised November 2020)		Same Frequency for all Tests (Minimums)												
MATERIAL AND OPERATION	DESCRIPTION OF TEST	TEST METHOD			FORM 734-	Quality Control		Quality Assurance										
		ODOT	WAQTC	AASHTO		Contractor Quality Control Type D	Contractor Quality Control Type E	Contractor Quality Control Type D	Contractor Quality Control Type E									
SECTION 00735 - EMULSIFIED ASPHALT CONCRETE PAVEMENT (CONTINUED)																		
Mixture Acceptance																		
% Emulsified Asphalt <i>(1) Required at start of production and if meters fail to meet specification</i>	Sampling Reducing Sieve Analysis Moisture Content	R 90 R 76 T 27/T 11 T 255			2277 2277	Provide Process Control	Visual	Review Documentation for Acceptance										
											Emulsified Asphalt Cement	Compliance	TM 321 (1) TM 322	R 66	4000	Provide Suppliers Certificate of Compliance	Provide Suppliers Certificate of Compliance	Review Documentation for Acceptance
SECTION 00740 - COMMERCIAL ASPHALT CONCRETE PAVEMENT (CACP)																		
See Specifications when Testing is Required by Agency																		
						Provide Process Control	Visual	Review Documentation for Acceptance										

FIELD TESTED MATERIALS ACCEPTANCE GUIDE				(Revised November 2020)		Same Frequency for all Tests (Minimums)		
MATERIAL AND OPERATION	DESCRIPTION OF TEST	TEST METHOD			FORM 734-	Quality Control		Quality Assurance
		ODOT	WAQTC	AASHTO		Contractor Quality Control Type D	Contractor Quality Control Type E	
SECTION 00743 - POROUS ASPHALT CONCRETE (PAC)								
Aggregate Production								
(1) QAE may waive after 5 sublots/shifts	Soundness Abrasion Degradation Lightweight Pieces Plasticity Index	TM 208			4000	Contractor Provided Testing Minimum 1 per Project	Contractor Quality Control Type E	Review Documentation for Acceptance
					4000			
(2) Not required for ATPB Mix (3) Coarse Agg (+ No. 4) (4) Fine Agg (- No. 4)	Sampling Reducing (3)(4) Sieve Analysis (1)(4) Sand Equivalent				1792	1/Sublot & Start of Production	Contractor Provided Testing	Review Documentation for Acceptance
					1792			
A Sublot equals 1000 Tons. A minimum one per shift whichever results in the greatest sampling frequency								
Preproduced Aggregate								
(1)(2)(3) Elongated Pieces TM 229 (3)(4) Fracture (Method 2) (1)(2)(3) Wood Particles TM 225					1792	1/5 Sublots & Start of Production	Contractor Provided Testing	Review Documentation for Acceptance
					1792			

Compliance of aggregates produced and stockpiled before the award date or notice to proceed of this contract will be determined by the following:

1. Continuing production records meeting the above requirements of Section 00743.10 Aggregate Production.
2. Furnish records of testing for the entire stockpile according to Section 00743.10 Aggregate Production except change the sampling frequency to the following:
 - a. One Per 5 sublots means "One Set of Tests Per 5000 Tons".
 - b. One Per sublot means "One Set of Tests Per 1000 Tons" with a minimum of 3 sets of Sieve Analysis tests per project.
 - c. Provide one stockpile sample for each set of tests required above.

FIELD TESTED MATERIALS ACCEPTANCE GUIDE				FORM 734- (Revised November 2020)		Same Frequency for all Tests (Minimums)		
MATERIAL AND OPERATION	DESCRIPTION OF TEST	TEST METHOD		FORM 734-	Quality Assurance			
		ODOT	WAQTC		AASHTO	Contractor Quality Control Type D	Contractor Quality Control Type E	Project Manager Type D & E
SECTION 00743 - POROUS ASPHALT CONCRETE (PAC) (CONTINUED)								
Mixture Acceptance - PAC with RAP								
Gradation								
Ignition method	(1) Calibrate Incinerator	TM 323			2327IC	1/JMF & Each Calendar Year.		
Ignition method	Sampling Reducing			R 97 R 47		1/Sublot or Min. 1/Day		
(Residual aggregate from AASHTO T 308)	Sieve analysis			T 30		1/Sublot or Min. 1/day		Review Documentation for Acceptance
⁽¹⁾ Submit Samples a minimum of 2 Days Prior to ACP Production								
Asphalt Content								
Ignition Method	(1) Calibrate Incinerator	TM 323			2327IC	1/JMF & Each Calendar Year.		
Ignition Method	Sampling Reducing			R 97 R 47		1/Sublot or Min. 1/day		
Meter Method	Asphalt Content			T 308				Review Documentation for Acceptance
	Readings backed by Tank measure & Production Records Daily	TM 321 (2) TM 322				1/Sublot or Min. 1/day		
⁽²⁾ Required at start of production and if meters fail to meet specification								
<u>Meter Method is required for PAC even when acceptance is by Ignition Method</u>								

FIELD TESTED MATERIALS ACCEPTANCE GUIDE				(Revised November 2020)		Same Frequency for all Tests (Minimums)				
MATERIAL AND OPERATION	DESCRIPTION OF TEST	TEST METHOD		FORM 734-	Quality Control		Quality Assurance			
		ODOT	WAQTC		AASHTO	Contractor Quality Control Type D		Contractor Quality Control Type E		
SECTION 00743 - POROUS ASPHALT CONCRETE (PAC) (CONTINUED)										
Mixture Acceptance - PAC without RAP										
Gradation										
Cold Feed Method	Sampling Reducing Sieve Analysis				R 90 R 76 T 27/T 11		1/Sublot or Min. 1/Day	Production Control Testing		Review Documentation for Acceptance
Ignition method	(1) Calibrate Incinerator	TM 323			2327IC		1/JMF & Each Calendar Year.	Production Control Testing		
Ignition method	Sampling Reducing				R 97 R 47		1/Sublot or Min. 1/Day	Production Control Testing		
(1) Not required if Asphalt Content Accepted by Meter Method	Sieve analysis				T 30		1/Sublot or Min. 1/day	Production Control Testing		Review Documentation for Acceptance
(Residual aggregate from AASHTO T 308)										
(1) Submit Samples a minimum of 2 Days Prior to ACP Production										
Asphalt Content										
Ignition Method	(1) Calibrate Incinerator	TM 323					1/JMF & Each Calendar Year.	Production Control Testing		Review Documentation for Acceptance
Ignition Method	Sampling Reducing Asphalt Content				R 97 R 47 T 308		1/Sublot or Min. 1/day	Production Control Testing		
(2) Required at start of production and if meters fail to meet specification	Readings backed by Tank measure & Production Records Daily	TM 321 (2) TM 322					1/Sublot or Min. 1/day	Production Control Testing		
Meter Method					2277		Daily Production	Production Control Testing		Review Documentation for Acceptance
<u>Meter Method is required for PAC even when acceptance is by Ignition Method</u>					2043 and 2401					

FIELD TESTED MATERIALS ACCEPTANCE GUIDE				(Revised November 2020)		Same Frequency for all Tests (Minimums)				
MATERIAL AND OPERATION	DESCRIPTION OF TEST	TEST METHOD			FORM 734-	Quality Control		Quality Assurance		
		ODOT	WAQTC	AASHTO		Contractor Quality Control Type D	Contractor Quality Control Type E	Project Manager Type D & E		
SECTION 00743 - POROUS ASPHALT CONCRETE (PAC) (CONTINUED)										
Mixture Acceptance - PAC with and without RAP										
Mix Design Verification Testing										
	Cold Feed Moisture				T255/T265	2277	1/Sublot or Min. 1/Day	Production Control Testing		Review Documentation for Acceptance
	Asphalt Mix Moist.				T 329	2277	1/Sublot or Min. 1/Day	Production Control Testing		Review Documentation for Acceptance
	⁽¹⁾ RAP Moisture				T 329	2277	1/Sublot or Min. 1/Day	Production Control Testing		Review Documentation for Acceptance
	Readings backed by Tank measure & Production Records Daily		TM321 ⁽²⁾ TM 322			2401 & 2043	Daily Production	Production Control Testing		Review Documentation for Acceptance
	Asphalt Cement				R 66	4000	1/Sublot See Section 4C	Provide Suppliers Certificate of Compliance		Review Documentation for Acceptance
	⁽²⁾ Required at start of production and if meters fail to meet specification									

FIELD TESTED MATERIALS ACCEPTANCE GUIDE				(Revised November 2020)		Same Frequency for all Tests (Minimums)			
MATERIAL AND OPERATION	DESCRIPTION OF TEST	TEST METHOD			FORM 734-	Quality Control		Quality Assurance	
		ODOT	WAQTC	AASHTO		Contractor Quality Control Type D	Contractor Quality Control Type E	Project Manager Type D & E	
SECTION 00744 - ASPHALT CONCRETE PAVEMENT									
Aggregate Production									
See Specifications when Aggregate Testing is Required by Agency									
Provide Process Control									
Visual									
Review Documentation for Acceptance									
Mixture Acceptance									
Gradation									
A Sublot equals 1000 Tons									
Ignition method	(1) Calibrate Incinerator	TM 323			2327IC	1/JMF & Each Calendar Year.	Production Control Testing		Review Documentation for Acceptance
Ignition method	Sampling Reducing			R 97 R 47		1/Sublot or Min. 1/Day	Production Control Testing		
(Residual aggregate from AASHTO T 308)	Sieve analysis			T 30	2277	1/Sublot or Min. 1/Day	Production Control Testing		Review Documentation for Acceptance
(1) Submit Samples a minimum of 2 Days Prior to ACP Production									
Asphalt Content									
A Sublot equals 1000 Tons									
Ignition Method	(1) Calibrate Incinerator	TM 323			2327IC	1/JMF & Each Calendar Year.	Production Control Testing		Review Documentation for Acceptance
Ignition Method	Sampling Reducing			R 97 R 47		1/Sublot or Min. 1/day	Production Control Testing		
	Asphalt Content			T 308	2277				
A Sublot equals 1000 Tons									
Mix Design Verification Testing									
Plant Discharge Moisture									
	Asphalt Mix Moist.			T 329	2277	1/Sublot			
Maximum Density Test G _{mm}	Max. Specific Gravity MAMD	TM 305		T 209	2050	1st Sublot Daily or Min. 1/Day	Production Control Testing		Review Documentation for Acceptance

FIELD TESTED MATERIALS ACCEPTANCE GUIDE				(Revised November 2020)			Same Frequency for all Tests (Minimums)		
MATERIAL AND OPERATION	DESCRIPTION OF TEST	TEST METHOD			FORM	Quality Control			
		ODOT	WAQTC	AASHTO		Contractor Quality Control Type D	Contractor Quality Control Type E	Quality Assurance	
SECTION 00744 - ASPHALT CONCRETE PAVEMENT (CONTINUED)									
Compaction	Nuclear Density			T 355	1793A	(D) Average 10 tests per Sublot or Min. 10/Day, See Section 00744.49	Production Control Testing	Review Documentation for Acceptance	

FIELD TESTED MATERIALS ACCEPTANCE GUIDE				(Revised November 2020)		Same Frequency for all Tests (Minimums)		
MATERIAL AND OPERATION	DESCRIPTION OF TEST	TEST METHOD		FORM 734-	Quality Control			
		ODOT	WAQTC		AASHTO	Contractor Quality Control Type D	Contractor Quality Control Type E	Project Manager Type D & E
SECTION 00745 - ASPHALT CONCRETE PAVEMENT - STATISTICAL ACCEPTANCE								
Aggregate Production ⁽¹⁾ QAE may waive after 5 sublots/shifts ⁽²⁾ Perform a minimum of 3 tests QL's required ⁽³⁾ Coarse Agg (+ No. 4) ⁽⁴⁾ Fine Agg (- No. 4) Note: Sample Aggregate before Lime Treatment RAS Production (Reclaimed Asphalt Shingles)	Soundness				4000	Contractor Provided Testing Minimum 1 per Project	Contractor Quality Control Type E	Review Documentation for Acceptance
	Abrasion	TM 208		T 104 T 96	4000	Contractor Provided Testing Minimum 1 per Project	Contractor Quality Control Type E	Review Documentation for Acceptance
	Degradation			T 113 T 90	4000			
	Lightweight Pieces					A Sublot equals 1000 Tons. A minimum one per shift whichever results in the greatest sampling frequency		
	Plasticity Index							
	Sampling			R 90 R 76 T 27/T 11 T 176	1792	1/Sublot & Start of Production	Contractor Provided Testing	Review Documentation for Acceptance
	Reducing							
	⁽²⁾⁽³⁾⁽⁴⁾ Sieve Analysis							
	⁽¹⁾⁽⁴⁾ Sand Equivalent							
	⁽¹⁾⁽³⁾ Elongated Pieces	TM 229		T 335	1792	1/5 Sublots & Start of Production	Contractor Provided Testing	Review Documentation for Acceptance
⁽³⁾⁽⁴⁾ Fracture (Method 2)								
⁽¹⁾⁽³⁾ Wood Particles	TM 225							
Sieve Analysis								
Deleterious Materials	TM 335		T 27	4000	Contractor Provided Testing 1/500 Tons	Contractor Provided Testing	Review Documentation for Acceptance	
Sampling								
Reducing			R 90 R 76 T 27					
Sieve Analysis								
Deleterious Materials	TM 335			1792				
Preproduced Aggregate								
Compliance of aggregates produced and stockpiled before the award date or notice to proceed of this contract will be determined by the following: 1. Continuing production records meeting the above requirements of Section 00745.10 Aggregate Production. 2. Furnish records of testing for the entire stockpile according to Section 00745.10 Aggregate Production except change the sampling frequency to the following: a. One Per 5 sublots means "One Set of Tests Per 5000 Tons". b. One Per sublot means "One Set of Tests Per 1000 Tons" with a minimum of 3 sets of Sieve Analysis tests per project. c. Provide one stockpile sample for each set of tests required above.								

FIELD TESTED MATERIALS ACCEPTANCE GUIDE				Same Frequency for all Tests (Minimums)			
MATERIAL AND OPERATION	DESCRIPTION OF TEST	TEST METHOD		FORM 734-	Quality Control		Quality Assurance
		ODOT	WAQTC		AASHTO	Contractor Quality Control Type D	
SECTION 00745 - ASPHALT CONCRETE PAVEMENT - STATISTICAL ACCEPTANCE (CONTINUED)							
Mixture Acceptance - ACP "With and Without RAP"							
Gradation							
Ignition method	(1) Calibrate Incinerator	TM 323			2327IC	A Sublot equals 1000 Tons	
Ignition method	Sampling Reducing Sieve analysis		R 97 R 47 T 30		1/JMF & Each Calendar Year. 1/Sublot	Production Control Testing	Review Documentation for Acceptance
(Residual aggregate from AASHTO T 308)					2277		
(1) Submit Samples a minimum of 2 Days Prior to ACP Production							
Asphalt Content							
Ignition Method	(1) Calibrate Incinerator	TM 323			2327IC	A Sublot equals 1000 Tons	
Ignition Method	Sampling Reducing Asphalt Content		R 97 R 47 T 308		1/JMF & Each Calendar Year. 1/Sublot or Min. 1/day	Production Control Testing	Review Documentation for Acceptance
(2) RAP Percentage	Meter Method	TM 321 (3) TM 322			2277		
(2) If Applicable							
(3) Required at start of production and if meters fail to meet specification	(2) RAP Moisture Cold Feed Moisture		T 329 T255/T265		1/Sublot or Minimum 1/Day	Production Control Testing	Review Documentation for Acceptance
<u>Meter Method is required for ACP even when acceptance is by Ignition Method</u>	Readings backed by Tank measure & Production Records Daily	TM 321 (3) TM 322			2401 ACP	Production Control Testing	Review Documentation for Acceptance

FIELD TESTED MATERIALS ACCEPTANCE GUIDE				Same Frequency for all Tests (Minimums)			
MATERIAL AND OPERATION	DESCRIPTION OF TEST	TEST METHOD		FORM 734-	Quality Control		Quality Assurance
		ODOT	WAQTC		AASHTO	Contractor Quality Control Type D	
SECTION 00745 - ASPHALT CONCRETE PAVEMENT - STATISTICAL ACCEPTANCE (CONTINUED)							
Mixture Acceptance - ACP "With and Without RAP"							
A Sublot equals 1000 Tons							
Mix Design Verification Testing							
Fabrication	Gyratory Specimen	TM 326					
Maximum Density Test	Max. Specific Gravity			T 209	2050GV 2050 *5068 *2560 *5069	1/Sublot & according to Section 00745.16 (b)-1-d	Production Control Testing Review Documentation for Acceptance
Determination of G_{mb}	Bulk Specific Gravity			T 166			
Stripping Susceptibility	Tensile Strength Ratio			T 283	2050tsr	1/JMF See Section 00745.16 (b)-1-f	Production Control Testing Review Documentation for Acceptance
*Cat-II complete & submit as required, See Section 745.16(b)							
Plant Discharge Moisture	Asphalt Mix Moist.			T 329	2277	1/Sublot	
Maximum Density Test G_{mm}	Max. Specific Gravity MAMD			T 209	2050	1st Sublot Daily or Min. 1/Day	Production Control Testing Review Documentation for Acceptance
Performing Control Strip	Control Strip	TM 305					
Compaction	Nuclear Density	TM 306		T 355	2084 *5069 1793A	Develop Rolling Pattern See Specs. (D) Average 5 tests per Sublot or Min. 1/Day, See Section 00745.49 (b)-2	Production Control Testing Review Documentation for Acceptance
Asphalt Cement	Compliance			R 66	4000	1/Sublot See Section 4C	Provide Suppliers Certificate of Compliance Review Documentation for Acceptance
(D) See T 355 YellowSheet for Density Test Locations							

FIELD TESTED MATERIALS ACCEPTANCE GUIDE				(Revised November 2020)		Same Frequency for all Tests (Minimums)			
MATERIAL AND OPERATION	DESCRIPTION OF TEST	TEST METHOD			FORM 734-	Quality Control		Quality Assurance	
		ODOT	WAQTC	AASHTO		Contractor Quality Control Type D	Contractor Quality Control Type E		Project Manager Type D & E
SECTION 00754 - PLAIN CONCRETE PAVEMENT REPAIR									
SECTION 00755 - CONTINUOUSLY REINFORCED CONCRETE PAVEMENT									
SECTION 00756 - PLAIN CONCRETE PAVEMENT									
SECTION 00758 - CONTINUOUSLY REINFORCED CONCRETE PAVEMENT REPAIR									
Aggregate Production									
⁽¹⁾ QAE may waive after 5 sublots/shifts	Sampling Reducing ^{(2),(3),(4)} Sieve Analysis ⁽⁴⁾ Fineness Modulus ⁽⁴⁾ Sand Equivalent			R 90 R 76 T 27/T 11	1792		Contractor Provided Testing	Contractor Quality Control Type E	Review Documentation for Acceptance
⁽²⁾ Perform a minimum of 3 tests, QL's required				T 176	1792		Contractor Provided Testing		
⁽³⁾ Coarse Aggregate (See Section 02690.20)	^{(1),(3)} Wood Particles ⁽³⁾ Fracture (Method 2) ^{(1),(3)} Elongated Pieces	TM 225		T 335	1792		Contractor Provided Testing 1/5 Sublots & Start of Production	Contractor Quality Control Type E	Review Documentation for Acceptance
⁽⁴⁾ Fine Aggregate (See Section 02690.30)	Abrasion Degradation Soundness Lightweight Pieces Organics	TM 208		T 96 T 104 T 113 T 21	4000		Minimum 1 per Project	Contractor Quality Control Type E	Review Documentation for Acceptance
	⁽³⁾ Dry Rodded Unit Weight ^{(3),(4)} Bulk Specific Gravity & Absorption			T 19 T 84 & T 85	1825 1825C 1825		Start of production and when changes in aggregate occurs	Contractor Quality Control Type E	Review Documentation for Acceptance
A Sublot equals 1000 Tons									

FIELD TESTED MATERIALS ACCEPTANCE GUIDE				(Revised November 2020)		Same Frequency for all Tests (Minimums)		
MATERIAL AND OPERATION	DESCRIPTION OF TEST	TEST METHOD			FORM 734-	Quality Control		Quality Assurance
		ODOT	WAQTC	AASHTO		Contractor Quality Control Type D	Contractor Quality Control Type E	
SECTION 00754 - PLAIN CONCRETE PAVEMENT REPAIR								
SECTION 00755 - CONTINUOUSLY REINFORCED CONCRETE PAVEMENT								
SECTION 00756 - PLAIN CONCRETE PAVEMENT								
SECTION 00758 - CONTINUOUSLY REINFORCED CONCRETE PAVEMENT REPAIR (CONTINUED)								
Portland Cement Concrete								A Sublot equals 1000 lane feet of slip formed pavement or 100 yd ³ of non-slip formed PCC
Portland Cement Modifiers Admixtures		Materials must meet the requirements of Section 02001.10						
Curing Compounds		Material must meet the requirements of Section 02050						
Mixing Water		Material must meet the requirements of Section 02020						
Mixture	Sampling Air Content Slump Density (Unit Weight) Yield Concrete Temperature Water/Cement Ratio Batching	TM 2	T 152 T 119 T 121 T 121 T 309 T 121	3573WS or 4000C	Contractor Provided Testing - 1/sublot or Minimum 1 per Day	Visual	Provide Suppliers Certificate of Compliance	Review Documentation for Acceptance
(^S) 1 Set Represents a minimum of 3 Cylinders	Strength		T 22 & T 23	4000C	(^M) (^S) 1 Set of Cylinders per sublot or Minimum 1 set per Day	Visual		Review Documentation for Acceptance
(^M) Per Mix Design & Source		TM 769 TM 772			See Special Provisions	Production Control Testing		
Smoothness Certification of Profiler Equipment Determining IRI with an Inertial Laser Profiler					See Specs	Visual		
Thickness of Pavement	Sitting Measure	TM 775						

FIELD TESTED MATERIALS ACCEPTANCE GUIDE				(Revised November 2020)			Same Frequency for all Tests (Minimums)		
MATERIAL AND OPERATION	DESCRIPTION OF TEST	TEST METHOD			FORM 734-	Quality Control		Quality Assurance	
		ODOT	WAQTC	AASHTO		Contractor Quality Control Type D	Contractor Quality Control Type E		Project Manager Type D & E
SECTION 00850 - COMMON PROVISIONS FOR PAVEMENT MARKINGS									
Placement Evaluation "Retroreflectivity"									
In-Place Procedure evaluates Durable and High Performance Pavement Markings	Evaluation of Retroreflectivity Using Hand-Operated Instrument	TM 777			4101 thru 4105	See Special Provisions and Test Procedure for Testing Frequency	Visual	Review Documentation for Acceptance	

FIELD TESTED MATERIALS ACCEPTANCE GUIDE				(Revised November 2020)		Same Frequency for all Tests (Minimums)			
MATERIAL AND OPERATION	DESCRIPTION OF TEST	TEST METHOD			FORM 734-	Quality Control		Quality Assurance	
		ODOT	WAQTC	AASHTO		Contractor Quality Control Type D	Contractor Quality Control Type E		
SECTION 00921 - MAJOR SIGN SUPPORT DRILLED SHAFTS									
Aggregate Production									
(1) QAE may waive after 5 sublots/shifts	Sampling Reducing				R 90 R 76				Review Documentation for Acceptance
	(2)(3)(4) Sieve Analysis				T 27/T 11 T 27/T 11		Contractor Provided Testing	Contractor Provided Testing	
(2) Perform a minimum of 3 tests, QL's required	(4) Fineness Modulus				T 176				Review Documentation for Acceptance
	(1)(3) Wood Particles	TM 225					Contractor Provided Testing	Contractor Provided Testing	
(3) Coarse Aggregate (See Section 02690.20)	(4) Sand Equivalent								Review Documentation for Acceptance
	Soundness Abrasion				T 104 T 96		Contractor Provided Testing	Contractor Provided Testing	
(4) Fine Aggregate (See Section 02690.30)	Degradation Lightweight Pieces Organics	TM 208			T 113 T 21		Contractor Provided Testing	Contractor Provided Testing	Review Documentation for Acceptance
	(3) Dry Rodded Unit Weight				T 19			Minimum of 1 per Project	
Portland Cement Modifiers Admixtures	(3)(4) Bulk Specific Gravity & Absorption				1825 1825C 1825			Minimum of 1 per Project	Review Documentation for Acceptance
								Manufacture Compliance Statement	
Drilling Slurry	Slurry material must meet the requirements of Section 00921.14 & 00921.43(g)							Contractor Provided Testing	Review Documentation for Acceptance
								Manufacture Compliance Statement	
Grout	Material must meet the requirements of Section 02080							Contractor Provided Testing	Review Documentation for Acceptance
Mixing Water	Material must meet the requirements of Section 02020							Manufacture Compliance Statement	

FIELD TESTED MATERIALS ACCEPTANCE GUIDE

(Revised November 2020)

Same Frequency for all Tests (Minimums)

MATERIAL AND OPERATION	DESCRIPTION OF TEST	TEST METHOD			FORM 734-	Quality Control			Quality Assurance
		ODOT	WAQTC	AASHTO		Contractor Quality Control Type D	Contractor Quality Control Type E	Project Manager Type D & E	
SECTION 00921 - MAJOR SIGN SUPPORT DRILLED SHAFTS									
Portland Cement Concrete									
	Sampling Slump	TM 2			3573WS or 4000C			(M) (S) 1 per Shaft and Test at minimum frequencies according to table 00512-1. Review specs.	Review Documentation for Acceptance
	Concrete Temperature								
	Density (Unit Weight) Yield								
	Water/Cement Ratio								
	Strength				4000C				
<p>(S) 1 Set Represents a minimum of 3 Cylinders</p> <p>(M) Per Mix Design & Source</p>									

TABLE 00512-1 Frequency of Quality Control Testing

Minimum frequencies per Class of concrete based on daily production records.	
<u>Production</u>	<u>Frequencies</u>
0 to 100 yd ³ on a single day	1 Set each day
<u>Quantity Over 100 yd³</u>	
100 to 600 yd ³ on a single day	1 Set per each 100 yd ³ or portion thereof
over 600 yd ³ on a single day	1 Set per each 200 yd ³ or portion thereof after reaching 600 yd ³