

**Chapter 5**

**Contents**

**5 Signal Plan ..... 5-1**

5.1 Roadway Design ..... 5-1

    5.1.1 Number of Lanes and Lane use ..... 5-1

    5.1.2 Pedestrian Crosswalks Closures ..... 5-1

    5.1.3 Selecting & Locating Curb Ramps for Proper Crosswalk Alignment ..... 5-2

    5.1.4 Signal Poles and Pedestals ..... 5-12

    5.1.5 Raised Median Islands and Crosswalk Alignment ..... 5-12

    5.1.6 Driveway Approaches at Signalized Intersections..... 5-18

    5.1.7 Maintenance Pads ..... 5-21

    5.1.8 Truck Turning Templates ..... 5-22

    5.1.9 Lane Shift Through Intersection (Off-set lane lines) ..... 5-27

5.2 Vehicle Signal Head Layout ..... 5-30

    5.2.1 Head Types ..... 5-30

    5.2.2 Head Placement..... 5-33

    5.2.3 Supplemental signal heads ..... 5-50

    5.2.4 Head Mounting ..... 5-56

    5.2.5 Signal Head Louvers and Angle Visors ..... 5-57

    5.2.6 Tattletale Indicators ..... 5-58

5.3 Sign Requirements and Layout..... 5-59

    5.3.1 Layout of Regulatory Signs ..... 5-62

    5.3.2 Street Name Signs and Guide Signs (Custom Designed Signs) ..... 5-63

    5.3.3 Part Time Restriction Signs (PTR)..... 5-63

    5.3.4 Materials and Mounting..... 5-64

5.4 Pedestrian Signal Equipment Layout..... 5-65

    5.4.1 Use of Pedestrian Detection..... 5-65

    5.4.2 Pushbutton Requirements ..... 5-65

    5.4.3 Deviations from Pushbutton Location Requirements ..... 5-66

    5.4.4 Verifying Pushbutton Requirements..... 5-67

5.4.5	Deviation: Pushbutton Mounted on a Large Pole .....	5-87
5.4.6	Deviation: Two Pushbuttons Mounted on a Single Pedestal.....	5-91
5.4.7	Deviation: Use of an Extension Bracket Mount .....	5-101
5.4.8	Deviation: Vertical Reach of Pushbutton.....	5-104
5.4.9	Pushbuttons Located Behind Guardrail .....	5-105
5.4.10	Extended Pushbutton Press Feature.....	5-105
5.4.11	Pedestrian Signal Location.....	5-106
5.4.12	Indication Type.....	5-108
5.4.13	Audible Pedestrian Signals.....	5-108
5.5	Pole Selection and Placement .....	5-108
5.5.1	Right-of-Way.....	5-108
5.5.2	Overhead Structures and Vertical Clearance Standards .....	5-108
5.5.3	Height Restrictions.....	5-109
5.5.4	Utility Conflicts .....	5-109
5.5.5	Roadside Placement Requirements .....	5-111
5.5.6	Mast Arm Poles .....	5-112
5.5.7	Strain Poles.....	5-112
5.5.8	Vehicle Pedestals – No Longer Used.....	5-112
5.5.9	Pedestals .....	5-113
5.5.10	Recessed Terminal Cabinet.....	5-113
5.5.11	Pushbutton Posts – No Longer Used .....	5-113
5.5.12	Non-Standard Design: Dual Mast Arm Poles, Strain Poles, Sign Bridge, Monotube, Luminaire Poles.....	5-113
5.5.13	Reusing or Altering the Loading on Existing Signal Supports.....	5-114
5.5.14	Use of Other Agency (Non-ODOT) Approved Poles .....	5-114
5.6	Illumination .....	5-115
5.6.1	Light Emitting Diode (LED) fixtures.....	5-116
5.6.2	Photo Electric Control Relay.....	5-116
5.6.3	Illumination Wiring .....	5-116
5.7	Fire Preemption.....	5-117

5.8 Power Source .....	5-118
5.9 Battery Back-Up .....	5-119
5.10 Controller Cabinets.....	5-120
5.10.1 Location .....	5-120
5.10.2 332S Controller Cabinet.....	5-122
5.10.3 332 Controller Cabinet.....	5-122
5.10.4 336 and 336S Controller Cabinet.....	5-122
5.10.5 Controller Cabinet Power .....	5-122
5.10.6 ATC Controller .....	5-123
5.11 Service Cabinets .....	5-125
5.11.1 Base Mounted Service Cabinet (BMC) .....	5-125
5.11.2 Base Mounted Service Cabinet with illumination (BMCL).....	5-125
5.11.3 Base Mounted Service Cabinet, Flashing Beacons (BMCF, and BMCFL) .....	5-125
5.11.4 Pole Mounted Service Cabinet (SC) and Meter Base (MC) .....	5-125
5.11.5 Remote Post Mounted Service (RPS).....	5-125
5.11.6 Wiring.....	5-125
5.12 Junction Boxes .....	5-126
5.12.1 Junction Box Type and Size .....	5-126
5.12.2 Junction Box Placement.....	5-126
5.12.3 Use of Existing Junction Boxes.....	5-128
5.12.4 Elevation Adjustments & Considerations for Existing Junction Boxes .....	5-129
5.12.5 Deviations From Junction Box Placement Standards .....	5-131
5.13 Conduit.....	5-132
5.13.1 Conduit Size.....	5-133
5.13.2 Conduit Materials .....	5-138
5.13.3 Expansion Fittings.....	5-138
5.13.4 Routing Conduit to Pedestals.....	5-139
5.13.5 Conduit Trenching Depths & Underground Conflicts.....	5-142
5.14 Wiring.....	5-143
5.14.1 Wire Types .....	5-143

5.14.2 Wire Gauge .....5-145

5.14.3 Voltage Drop.....5-145

5.14.4 Bonding/Grounding Requirements .....5-146

5.14.5 Common/Neutral (Shared) Wire .....5-146

5.14.6 Wiring Signal Heads (From Head to Terminal Cabinet).....5-147

5.14.7 Wiring Pedestrian Signals and Pushbuttons.....5-156

5.14.8 Wiring Signal Phases (from Terminal Cabinet to Controller) .....5-158

5.14.9 Wire Fill at the Terminal Cabinet Entrance and Mast Arm Connection .....5-160

5.14.10Wiring Part Time Restriction (PTR) signs.....5-163

5.15 Background/Reference Information .....5-163

5.15.1 Wiring History .....5-163

5.15.2 Type 3LCF Signal Heads for Flashing Yellow Arrow.....5-163

5.15.3 Sign History .....5-165

## 5 Signal Plan

This chapter will discuss all the design elements that are shown on a sign plan sheet, in order of the recommended process for designing a new traffic signal.

There are many ways to design a traffic signal. In this chapter, there is flexibility for some design elements based on the region electrical crew preferences. It is critical to coordinate with the region electrical crew during the design phase to ensure maintenance concerns are addressed.

### 5.1 Roadway Design

The signal design work starts with the roadway base map and geometric design. It is important to review the roadway geometric design and work with the roadway designer early in the process, as fundamental roadway features such as the number of lanes, the lane use, horizontal/vertical alignment, and the curb ramp locations all have a direct impact on how the signal will be designed.

For projects without any roadway design work or survey data, see chapter 21 for information on drafting the necessary roadway features.

#### 5.1.1 Number of Lanes and Lane use

The operational approval for the traffic signal will show the required number of lanes, lane use, and signal phasing. The roadway design must match what is shown in the operational approval. Any discrepancy between the roadway design and the operational approval must be resolved, either by amending the operational approval (typically requires an additional engineering study) or by correcting the roadway design.

#### 5.1.2 Pedestrian Crosswalks Closures

The operational approval for the traffic signal will indicate where the signalized pedestrian crossings are located and will identify any crosswalk closures. Crosswalk closures will normally be approved in a separate approval letter where the requirements for closure treatments will be specified. Closure treatments will normally be required in both visual and detectable formats. Sign OR 22-7 is the standard visual treatment for a crosswalk closure; this sign will nearly always be required at crosswalk closure at a signalized intersection. The crosswalk closure support shown in standard drawing TM240 is a typical treatment to meet the requirements for a detectable barrier/feature, but other treatments may be used such as a buffer strip or a railing. The detectable feature must convey that the crossing is closed to all pedestrians (including those with visual impairments) to comply with ADA. A detectable barrier/feature will nearly always be required when there is a sidewalk at a closed crosswalk. See the ODOT Traffic Manual for additional information on crosswalk closures.

Crosswalk closure supports (TM240) and “CROSSWALK CLOSED” signs (OR22-7) used at signalized intersections are typically shown on the signal plan sheet, NOT on the signing plan sheet. Crosswalk closure supports are also required to be shown on the curb ramp detail sheet. The signal designer should review the curb ramp detail sheet to ensure it matches what is shown in the signal plans. Crosswalk closure supports are no longer included in the traffic signal lump sum bid item. Instead, use the bid item in specification 00902 (see chapter 19).

It is likely that a project will include crosswalk closure supports at unsignalized intersections. These are typically shown on the signing plan sheet and will use the same 00902 specification and bid item. Coordinate with the sign designer to determine the EOR for the 00902 specifications and ensure the bid item quantity is correct.

Verify that all crosswalk closures (even existing closed crosswalks) have been approved by the state traffic-roadway engineer. If there is no documented operational approval for the closure, either the crosswalk must be opened OR a request for closure will need to be submitted by region traffic.

Follow the requirements stated in the crosswalk closure operational approval. If these requirements are not met, the crosswalk closure will not pass ADA inspection.

### 5.1.3 Selecting & Locating Curb Ramps for Proper Crosswalk Alignment

Each signalized crosswalk shall:

- Be marked with appropriate crosswalk pavement markings as per the ODOT Traffic Line Manual.
- Have a separate curb ramp at each end of the crosswalk if sidewalk is present. If no sidewalk is present, (e.g. rural locations and interchange ramps), a level pedestrian pad outside the normal roadway shoulder in lieu of curb ramps should be used. If a pedestrian pad outside the normal roadway shoulder isn't feasible, a level landing area within the shoulder that will not be encroached by vehicles is acceptable. See section 5.1.8, Figure 5-21 and Figure 5-22 for more information on verifying the vehicle swept path does not encroach on the pedestrian access route.

**Note that an ADA curb ramp design exception is required when a single curb ramp is used for more than 1 crosswalk, a level area is not provided, or fails to meet the clear space dimensions. The signal designer or the roadway designer will need to prepare the design exception request – contact the roadway designer for assistance.** While having separate curb ramps at the end of each crosswalk is the default standard because it provides better information for a visually impaired pedestrian to line-up and navigate the crossing, there are situations where providing this standard may result in the following:

- Crosswalk alignment that has extremely poor driver visibility to pedestrians when making permissive right or left turns. See Figure 5-1 and Figure 5-2 for examples. This requires a solution that will maximize the available sight distance or mitigate the concern in an acceptable manner.
- Extremely poor driver visibility to other vehicles that requires the addition of NO TURN ON RED signs. See Figure 5-3 for example. This requires further evaluation from region traffic to determine if restricting right turns on red is acceptable. Overuse of NO TURN ON RED have a higher risk of being disregarded and drivers may block the crosswalk to increase their line of sight. Correction of this behavior requires regular enforcement, which is difficult to get with limited resources.
- A significant reduction in left/right turn storage. See Figure 5-4 for example. This requires further evaluation from region traffic to determine if a decrease in storage length is acceptable. Inadequate storage lengths for turning movements can result in an increased risk of rear-end, run-off the road, or sideswipe crashes due to spill back into through lanes.

These situations tend to occur at intersections with small radii and/or where buildings or vegetation are close to the back of curb as it is very difficult to install two adjacent curb ramps on a small radius without pushing the crosswalk alignments further away from the intersection. In these situations, the sight lines and potential safety/operational impacts (for all modes or travel) must be evaluated to determine the best placement of curb ramp(s) and crosswalks. Solutions could include using different ramp styles, closing crosswalk(s), and changing signal phasing/timing, but the best solution may be one single curb ramp on the radius. A design exception is still required, but should be approved with brief documentation of the sight line issues or inadequate storage distance that would result if using two adjacent curb ramps.

Evaluate sight lines when revising any existing or adding any new curb ramp locations/crosswalk alignments.

Intersections with tight radii or buildings/vegetation close to the back of curb deserve additional attention. The best solution is likely one single curb ramp on the radius (design exception is required).

Figure 5-1 | Poor Visibility to Pedestrians (Permissive Right Turn) Example

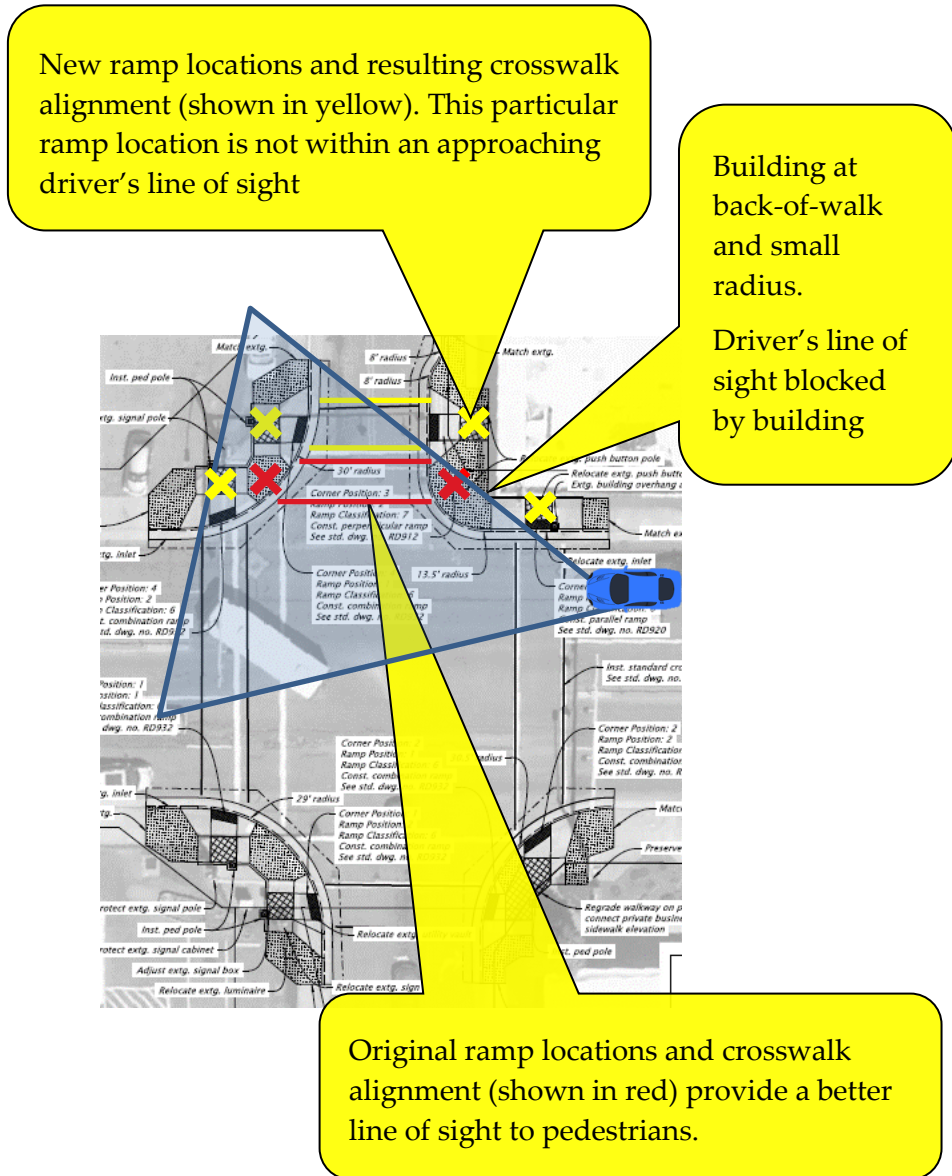






Figure 5-3 | Poor Visibility to Vehicles (NO TURN ON RED Signs) Example

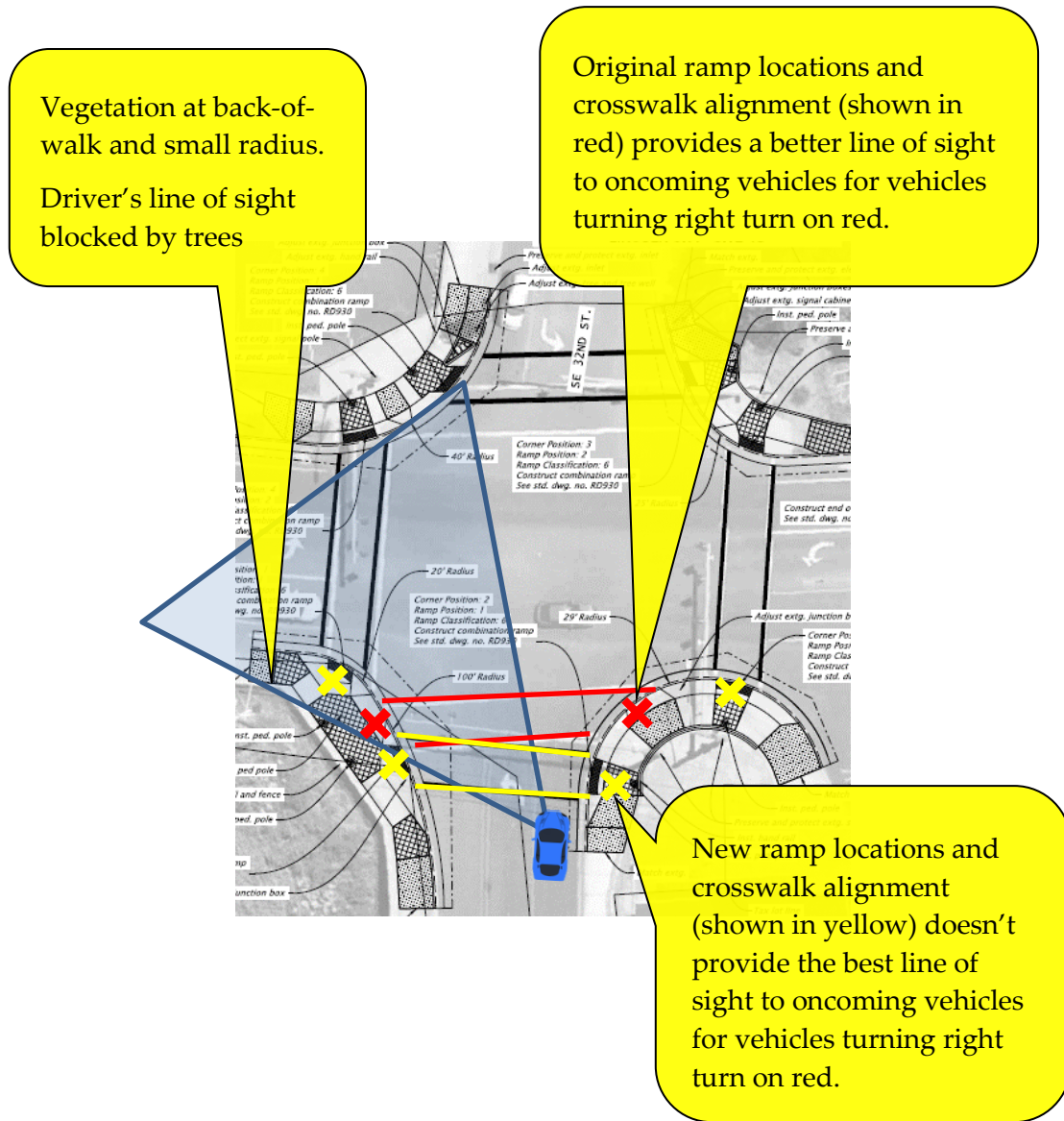
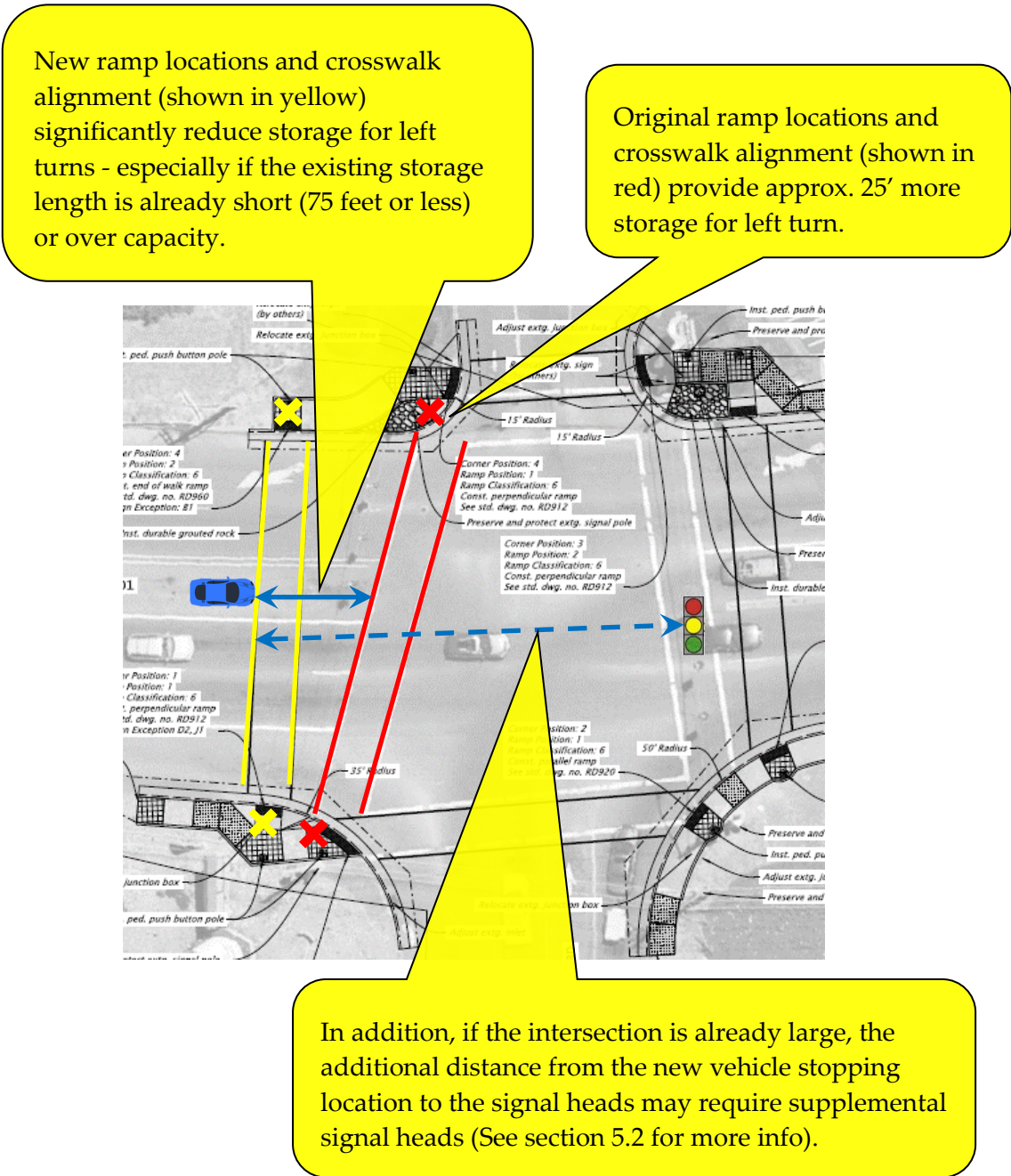


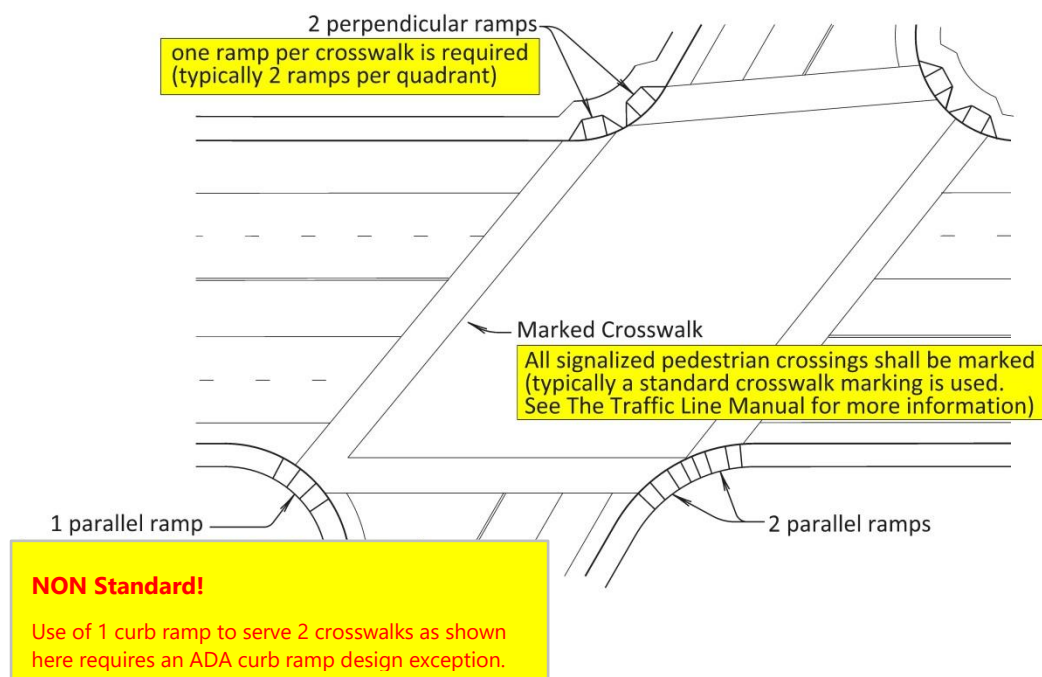
Figure 5-4 | Significant Reduction in Turn Lane Storage Example



When locating curb ramps and crosswalks, consult the latest roadway standard drawings for current curb ramp configurations and discuss with the roadway designer. See Figure 5-5 for an example showing the basic curb ramps requirements. The roadway designer is responsible for the curb ramp design, but the signal designer should be involved in the selection and placement of the curb ramps as the following signal design features are dependent on curb ramp type and placement:

- Crosswalk alignment and stopping location for vehicles (affects line of sight, storage lengths, signal timing parameters, and detection system)
- Location of signal poles
- Location of pedestals
- Location of pushbuttons

Figure 5-5 | Basic Curb Ramp Requirements for Signalized Intersection



There are three main objectives for proper crosswalk alignment:

1. **To maximize the visibility of the pedestrian and maintain a good line of sight between the pedestrian and the motorist.** To accomplish this, place the crosswalk as close to intersection as possible (as opposed to crosswalk located beyond the intersection radii). Figure 5-6 illustrates this crosswalk placement. Note: this configuration may result in needing advance stop lines at heavily skewed intersections.
2. **To reduce the amount of exposure the pedestrian has in the intersection.** To accomplish this, place the crosswalk perpendicular to the travel lanes that are crossed. This results in the shortest path for the pedestrian and the most efficient signal timing. Figure 5-7 illustrates crosswalks this crosswalk placement. Having the shortest path is a very important consideration when the traffic signal is interconnected to a rail crossing, as it may not be feasible to obtain extra seconds from the rail equipment to accommodate the pedestrian clear-out interval (PCOI). However, this configuration does not really meet the first objective (especially for the side street right turning vehicles in Figure 5-7 which will be able to pick up quite a bit of speed before the crosswalk).
3. **To provide proper alignment cues for visually impaired pedestrians.** To accomplish this, place the crosswalk parallel to the concurrent vehicular traffic movement. Figure 5-6 illustrates this crosswalk placement. Note: skewed intersections are more difficult for those with vision impairments to align and orient themselves to cross the street compared to 90-degree intersections.

As Figure 5-6 and Figure 5-7 illustrate, the first two objectives will often times be in conflict with each other. The benefits of each strategy will need to be considered to determine the right balance. Figure 5-8 shows a good compromise. When possible, fixing the skew of the intersection is the preferred option to best address all three objectives (90-degree intersections are ideal for many reasons). Coordinate with region traffic concerning the needs of the pedestrian signal timing and the roadway designer for fixing or improving the intersection skew.

Selection and placement of curb ramps shall be done with the assistance of the roadway designer to determine the curb ramp type that best addresses all ADA and geometric design issues, while still addressing the signal design needs.

Figure 5-6 | Crosswalk Example 1

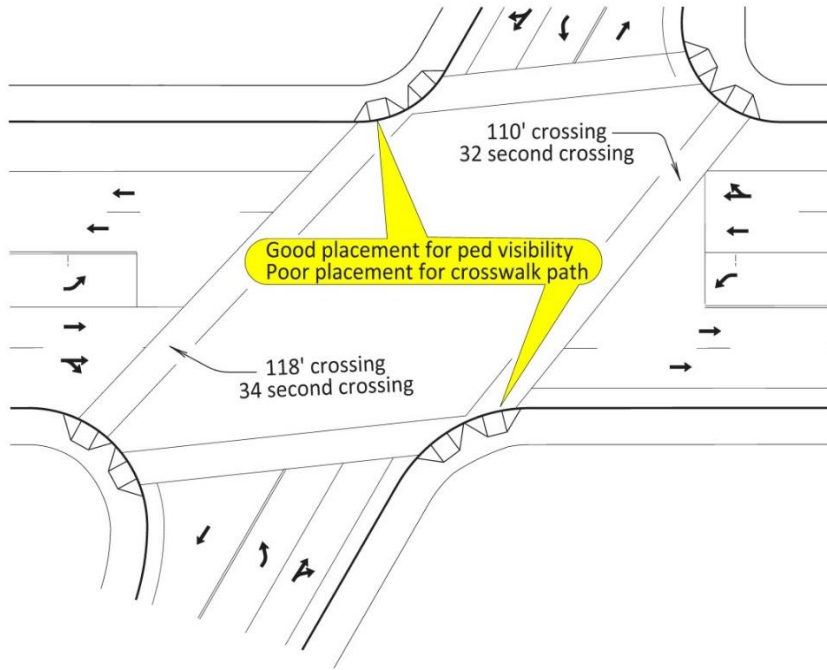


Figure 5-7 | Crosswalk Example 2

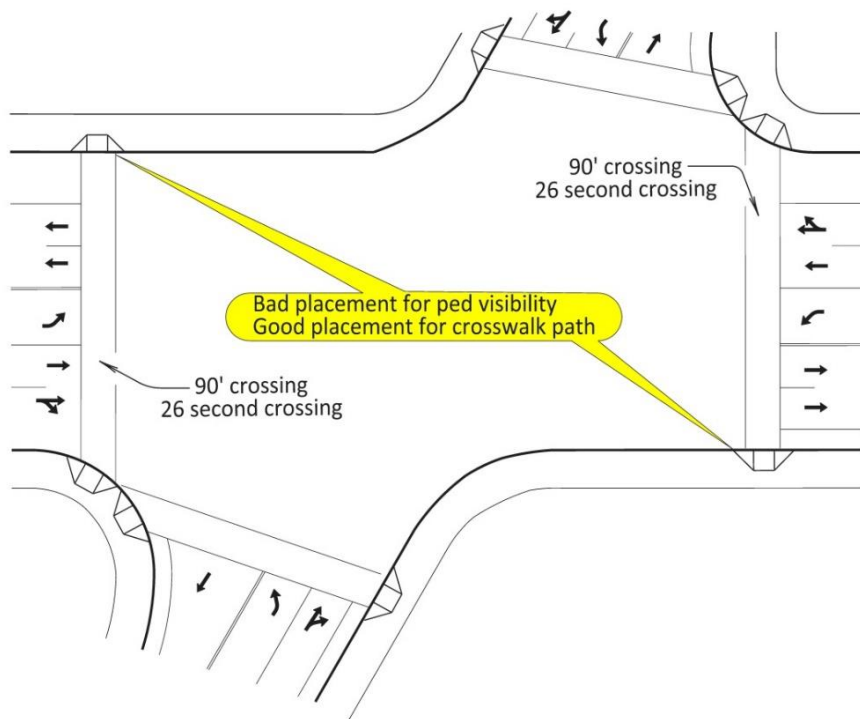
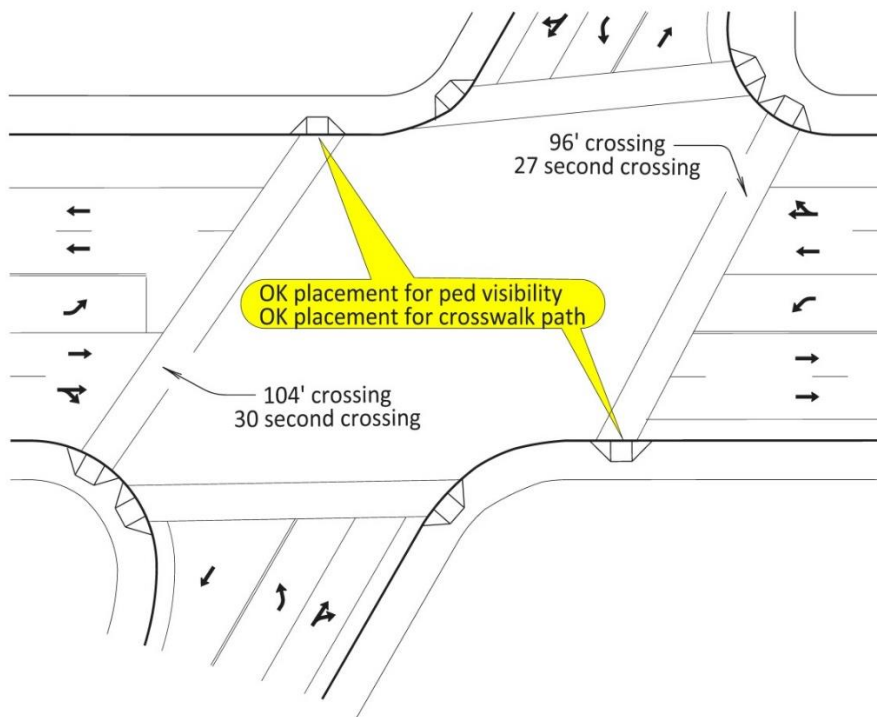


Figure 5-8 | Crosswalk Example 3



## **5.1.4 Signal Poles and Pedestals**

As per [technical bulletin RD17-01\(B\), ADA sidewalk curb ramp detail – minimum requirements in construction plans](#), roadway designers are required to show full detail of each curb ramp in the contract plans. This includes showing the exact location and critical elevations for signal poles, pedestals, and pushbutton locations. See roadway standard details DET1720 and DET1721 for examples of curb ramp details. The signal designer will need to work closely with the roadway designer during curb ramp design, following the guidance in section 5.4 to provide accurate pole and pedestal locations. The signal plan sheets should reference the curb ramp detail plan sheets.

## **5.1.5 Raised Median Islands and Crosswalk Alignment**

Raised median islands are recommended by the ODOT Highway Design Manual and Oregon Highway Plan based on the highway classification (e.g., statewide NHS routes) and to address certain safety, operational, and access concerns. The type of end treatment for the raised median island at signalized intersections should be carefully considered as it directly impacts the design of the pedestrian equipment and signal phasing.

### **Two-Phase Pedestrian Crossing**

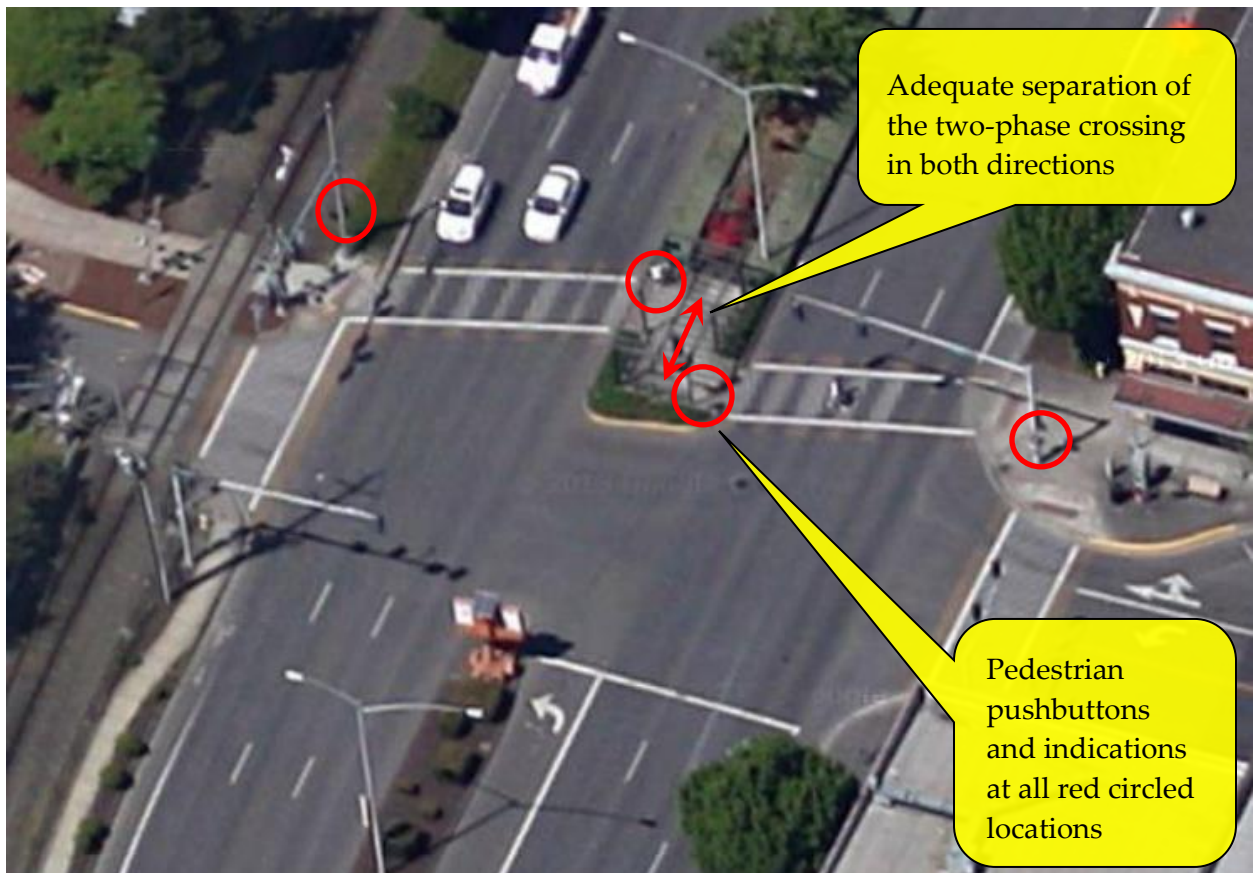
If a two-phase pedestrian crossing is required (according to the operational approval) the crosswalk configuration should be staggered with enough distance such that each phase of the pedestrian crossing is clearly defined. The pedestrian indications for the first phase of the crossing should not be visible to pedestrians using the second phase of the crossing (and vice-versa). See Figure 5-9 and Figure 5-10. This eliminates the potential confusion of which signal indication pertains to which crossing and the pedestrian using the wrong indication. Louvers and programmed heads are not an option for pedestrian indications. Count down heads can eliminate the confusion associated with non-staggered two-phase crossings (if the time for each of the two-phases is the same), but non-staggered two-phase crossings should be avoided when possible. Pushbuttons for each phase should also be separated and clearly indicate which crossing they apply to, preferably located on the same pedestal as the applicable pedestrian indication.



Figure 5-9 | Two-Phase Pedestrian Crossing (Staggered Crosswalk Alignment) Example 1



Figure 5-10 | Two-Phase Pedestrian Crossing (Staggered Crosswalk Alignment) Example 2



**Single Phase Pedestrian Crossing**

If a two-phase pedestrian crossing is NOT required (according to the operational approval) the crosswalk should be aligned as per section 5.1.3 with a median that ends prior to the crosswalk. This eliminates the need for a pushbutton located in the median as the design provides clear direction to the pedestrian that they will be crossing the entire crosswalk in one stage. See Figure 5-11 and Figure 5-12. Pushbuttons in the median, as shown Figure 5-13, in shall NOT be installed for a single phase pedestrian crossing where the raised median ends prior to the crosswalk (pedestrians should not be encouraged to take refuge where there is no pedestrian refuge).

Figure 5-11 | Single Phase, One Stage Pedestrian Crossing (Recommended Crosswalk & Median Design) Example 1



Figure 5-12 | Single Phase, One Stage Pedestrian Crossing (Recommended Crosswalk & Median Design) Example 2

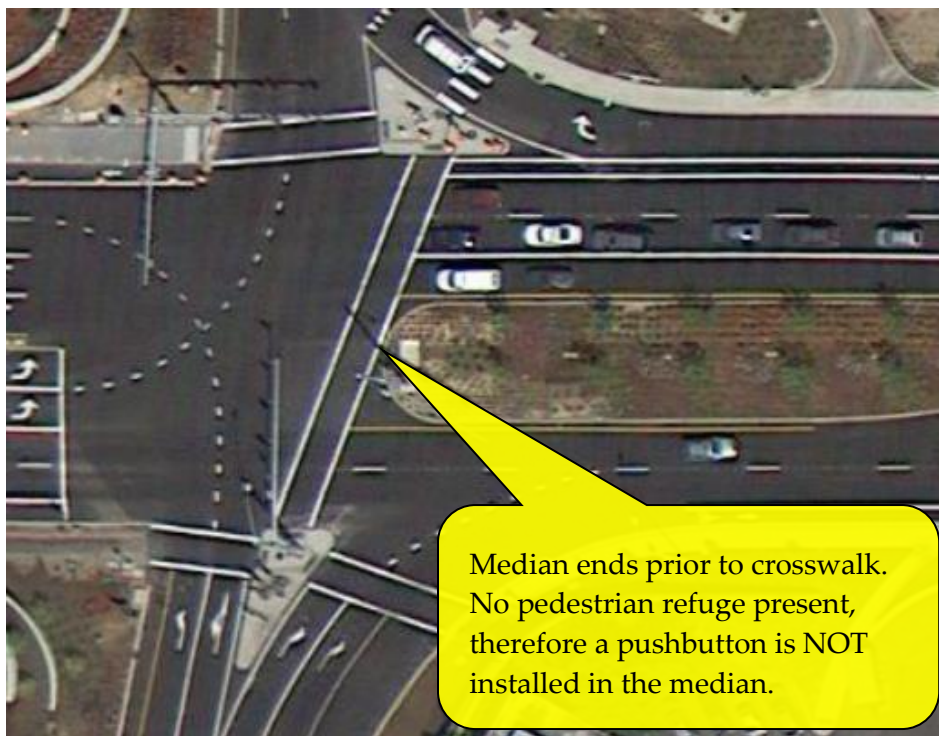
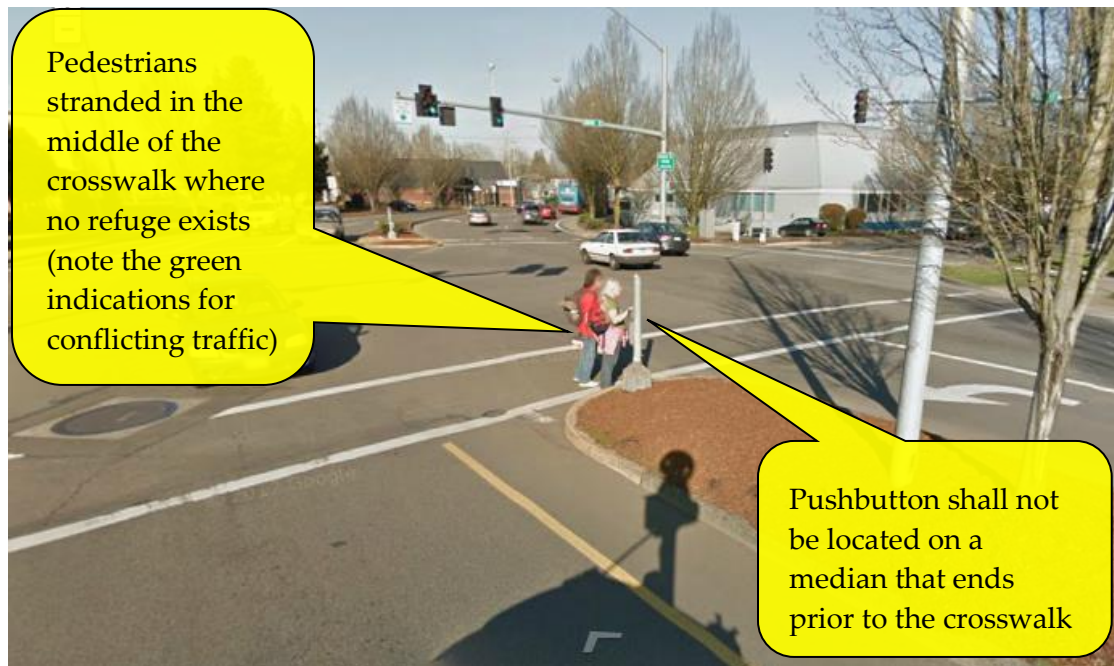


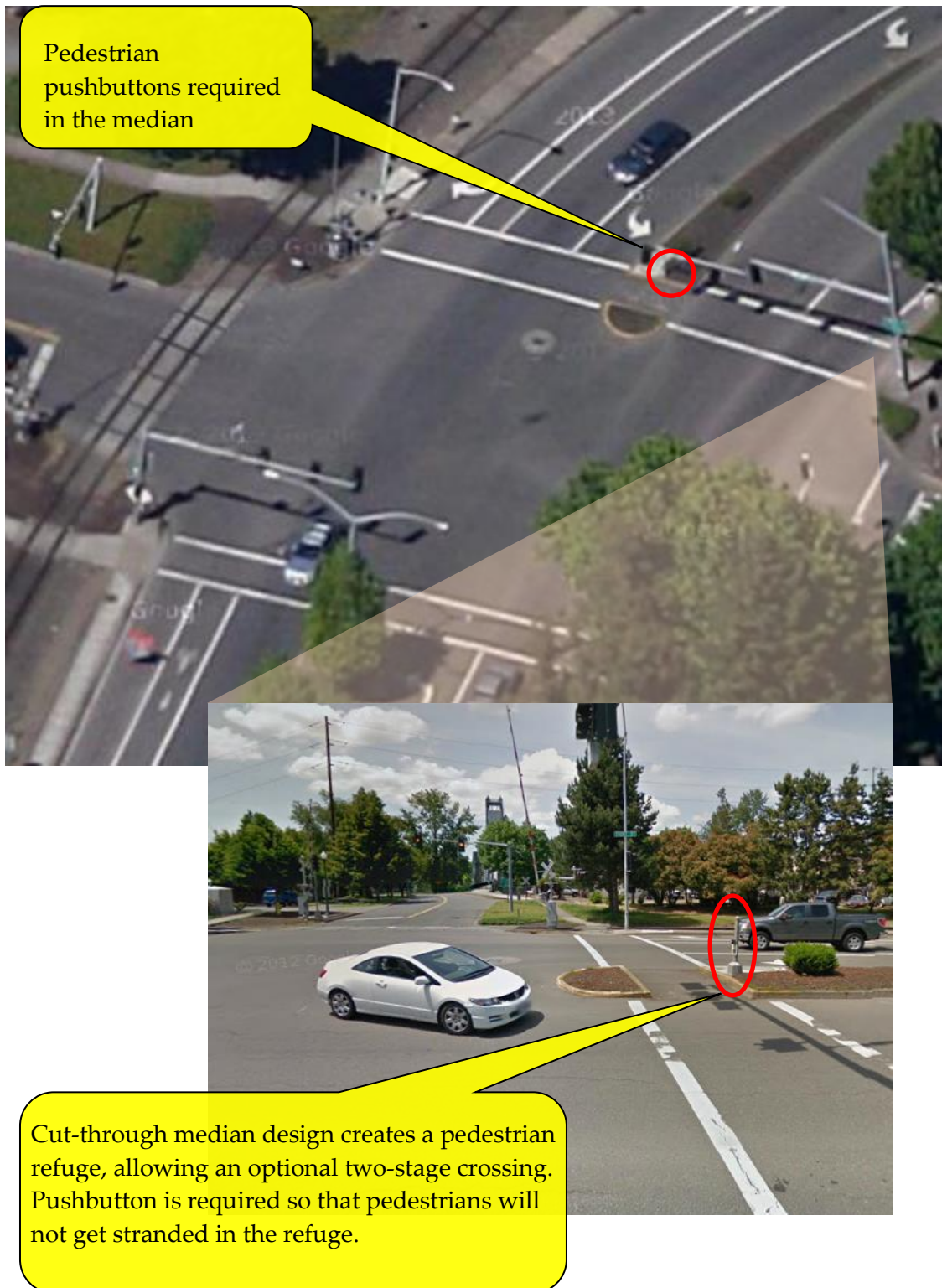
Figure 5-13 | Single Phase, Two Stage Pedestrian Crossing (Incorrect use of Median Pushbutton)



If the median is extended beyond the crosswalk with an accessible island (which may be cut-through), a pushbutton is required. See Figure 5-14. This is because the cut-through design allows pedestrians the option of a two-stage crossing, even though the pedestrian crossing is only a single phase (e.g., the pedestrian phase is timed to allow a pedestrian to cross the entire crosswalk, not just to the median). **A straight aligned crosswalk with a median cut-through should not operate as a two-phase pedestrian crossing (see two-phase pedestrian crossing requirements above).** Single phase, two-stage pedestrian crossings are not desirable and should be avoided for two reasons:

- The pushbutton in the median is often pushed by pedestrians even if they have no intention of making a two-stage crossing. This results in inefficient signal operations due to the pedestrian phase being serviced again in the next cycle when there is no demand. This is especially problematic if the signal is operating near, at, or over capacity.
- By placing a pedestrian refuge with a pushbutton in the median, pedestrians may be unsure if they should stop in the median and wait for the next walk/flashing don't walk to finish the crossing. The use of countdown pedestrian signal heads has largely eliminated this concern, as pedestrians now have info about the duration of the pedestrian phase and can make an informed decision if they should wait in the pedestrian refuge or not. However, this remains a concern for visually impaired pedestrians as audible information about the pedestrian phase duration is not provided by audible pedestrian signals.

Figure 5-14 | Single Phase, Two-Stage Pedestrian Crossing (Avoid This Crosswalk & Median Design)



## 5.1.6 Driveway Approaches at Signalized Intersections

All approaches of an intersection shall be signalized, even if an approach is only a driveway or alley and serves a very limited amount of traffic.

Figure 5-15 shows an example of a driveway forming the fourth approach of an intersection. Half signals or an unsignalized approach at the intersection are not allowed (this excludes right turn slip lanes which may be signalized, STOP or YIELD controlled as specified in the operational approval).

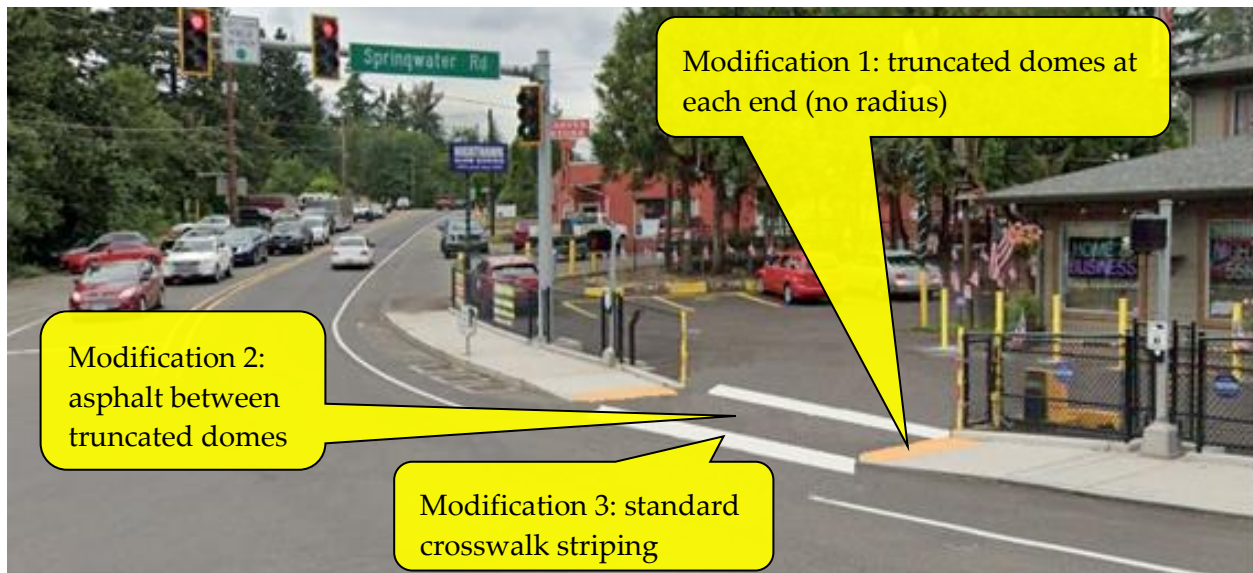
Figure 5-15 | Signalized Driveway Example



Typically, a driveway approach is designed according to the roadway standard drawings RD715 (non-sidewalk driveways) or RD725 thru RD750 (sidewalk driveways). Sidewalk driveway options shown in RD725 thru RD750 may only be used for a signalized driveway approach with the following modifications (see Figure 5-16 for example):

1. Truncated domes are required at each end to define the signalized pedestrian crossing. Coordinate with the traffic-roadway section to determine the proper site-specific location of the truncated domes and to address any slope/elevation issues.
2. Asphalt is required between the truncated domes (e.g. do NOT continue the sidewalk concrete)
3. Standard crosswalk striping is required

Figure 5-16 | Signalized Sidewalk Driveway Using Modified Roadway Standard Drawings



Another option that may be used when a driveway approach will be signalized is a small radius with curb ramps (and standard crosswalk striping) as shown in RD756. See Figure 5-18. Keep in mind that it may be difficult to get the geometrics to conform with roadway requirements and design exceptions are likely with this option.

Both options (driveway approach with the three listed modifications or a small radius with curb ramps) will make the approach look and feel like a typical signalized approach; drivers should be more likely to stop at the proper location and watch for pedestrians and pedestrians should be more likely to notice the pedestrian indications and comply. For comparison purposes, see Figure 5-17 showing the before photo of a signalized sidewalk driveway that lacks the “feel” of a typical signalized approach and Figure 5-18 showing the after photo with a new small radius, curb ramps and crosswalk striping.

Figure 5-17 | Signalized Sidewalk Driveway (Before Photo) – Avoid This Approach Design

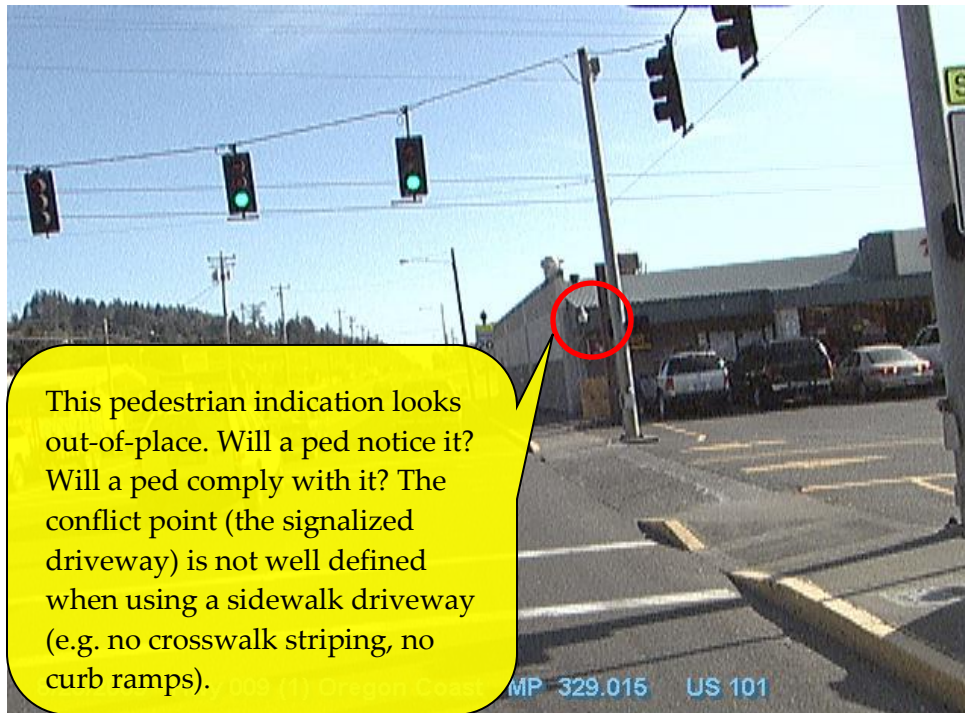


Figure 5-18 | Signalized Driveway with Small Radius and Curb Ramps (After Photo) – Use This Approach Design





## 5.1.7 Maintenance Pads

A maintenance pad provides a safe parking spot for near the intersection for electrical crews, TSSU and signal timers to use. See standard drawing RD160. Maintenance pads should be considered when requested by signal maintenance staff or under the following conditions:

- There are no parking lots near the signal
- There are steep slopes near the signal
- A maintenance vehicle could get stuck in mud during poor weather conditions
- A maintenance vehicle could block sidewalk, bike lanes, and/ or curb ramps
- Signal locations with high ADT (such as interchange ramps)
- Inadequate shoulder width

When used, work with the roadway designer and maintenance staff to determine the best location for the maintenance pad. It is also important to consider the location and design features that will discourage/minimize use by the public (intentional or non-intentional). For example, a maintenance pad might be construed as an extension of the pedestrian sidewalk/facility for those with vision impairments. Consult the ADA design team for assistance.

## 5.1.8 Truck Turning Templates

Truck turning templates of the design vehicle's swept path should be provided to verify the signal can operate as intended. It is best to verify the truck turning templates with a conceptual design as part of the operation approval. However, it is still necessary to check the actual design during the design phase and address any issues that may come up (either revise the design or revise the operational approval). The templates are provided by the roadway designer and should be verified by the signal designer and/or the region signal operations engineer.

If the truck turning templates identify any problems, the preferred solution is to fix the roadway geometry. Unfortunately, this may not always be feasible depending on right-of-way, scope, and/or budget constraints. If the roadway geometry cannot be fixed, other less desirable solutions that may be considered are discussed in the bullet points below.

The following movements should be verified:

- **Verify opposing left turns have enough room in the intersection to complete their movement and do not encroach on stopped vehicles.** Heavy skew angles, narrow lane widths, offset lane lines, and small intersections may have issues with overlapping swept paths or encroachment. If the roadway geometry can't be fixed, other solutions include split phasing (for overlapping swept paths) or adding advance stop lines (for encroachment). Advance stop lines shall be no more than 20 feet offset from the adjacent staggered stop line. The downside to these options should be considered before moving forward (split phasing is a very inefficient operation. Advance stop lines may have issues with compliance and detection coverage may be shortened). See Figure 5-19 and Figure 5-20.
- **Verify dual turns do not encroach on adjacent lanes or on stopped vehicles.** The same problems and solutions discussed in the above bullet apply. See Figure 5-19.
- **Verifying right turns do not encroach on sidewalk or pedestrian landing areas.** Tight radii, narrow sidewalks, or narrow shoulders can result in the design vehicle off-tracking where pedestrians wait to use the crosswalk. In addition, signal equipment that is placed along the radius (e.g. pedestrian signal indications, pushbuttons, pedestals/poles) can be vulnerable to damage. A minimum area of 4 feet for is needed for pedestrians, more is desirable. See Figure 5-21. If the roadway geometry can't be fixed (e.g., revise sidewalk, add shoulder width, or add a pedestrian landing area), another solution is pavement marking adjustments to define the pedestrian area and help modify the driver's path. See Figure 5-22. The downside to this option should be considered before moving forward (compliance issues and added cost of maintenance).

Figure 5-19 | Truck Turning Templates – Verifying Opposing Left Turns and Dual Turns

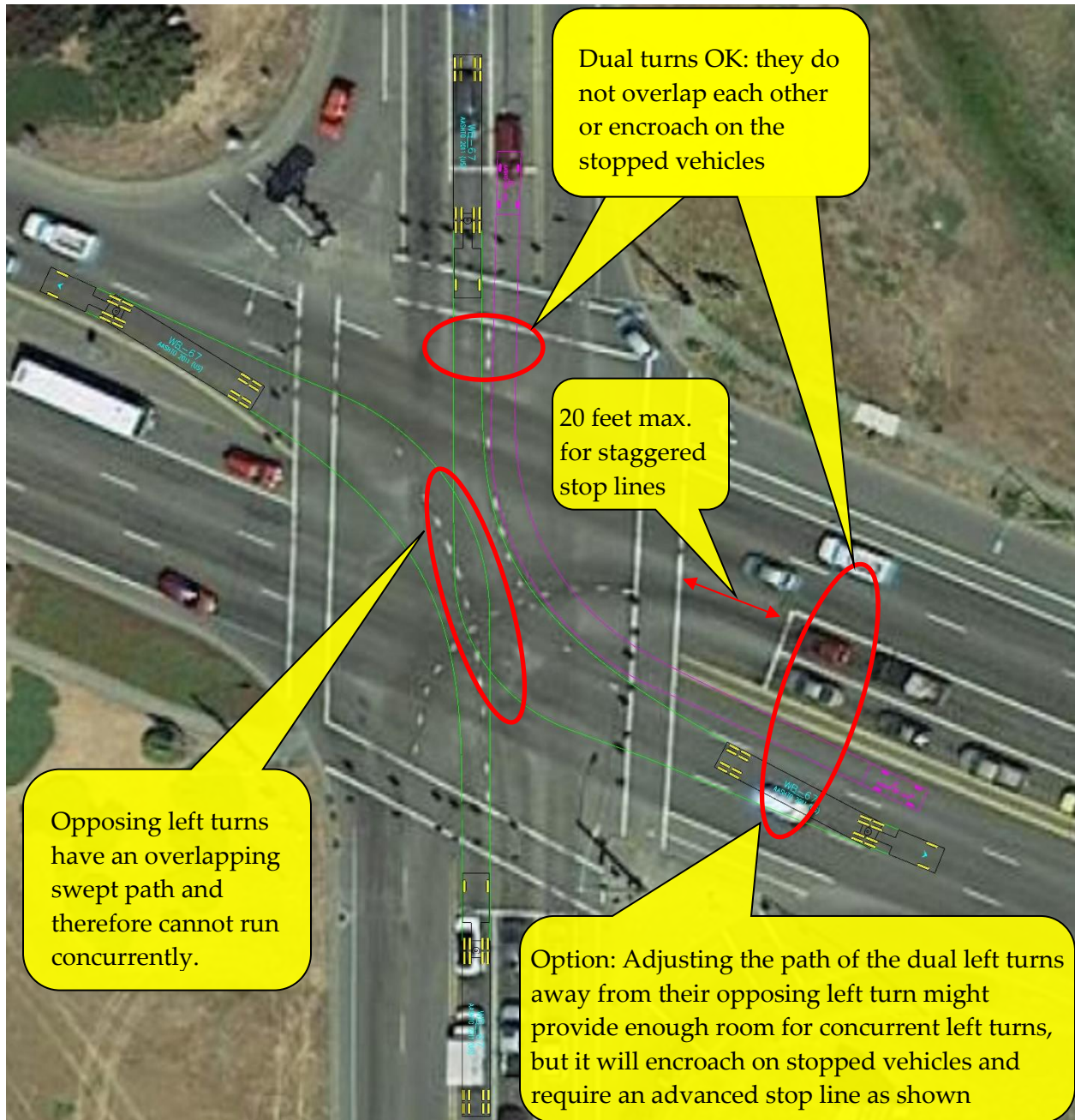


Figure 5-20 | Truck Turning Templates – Verifying Left Turns

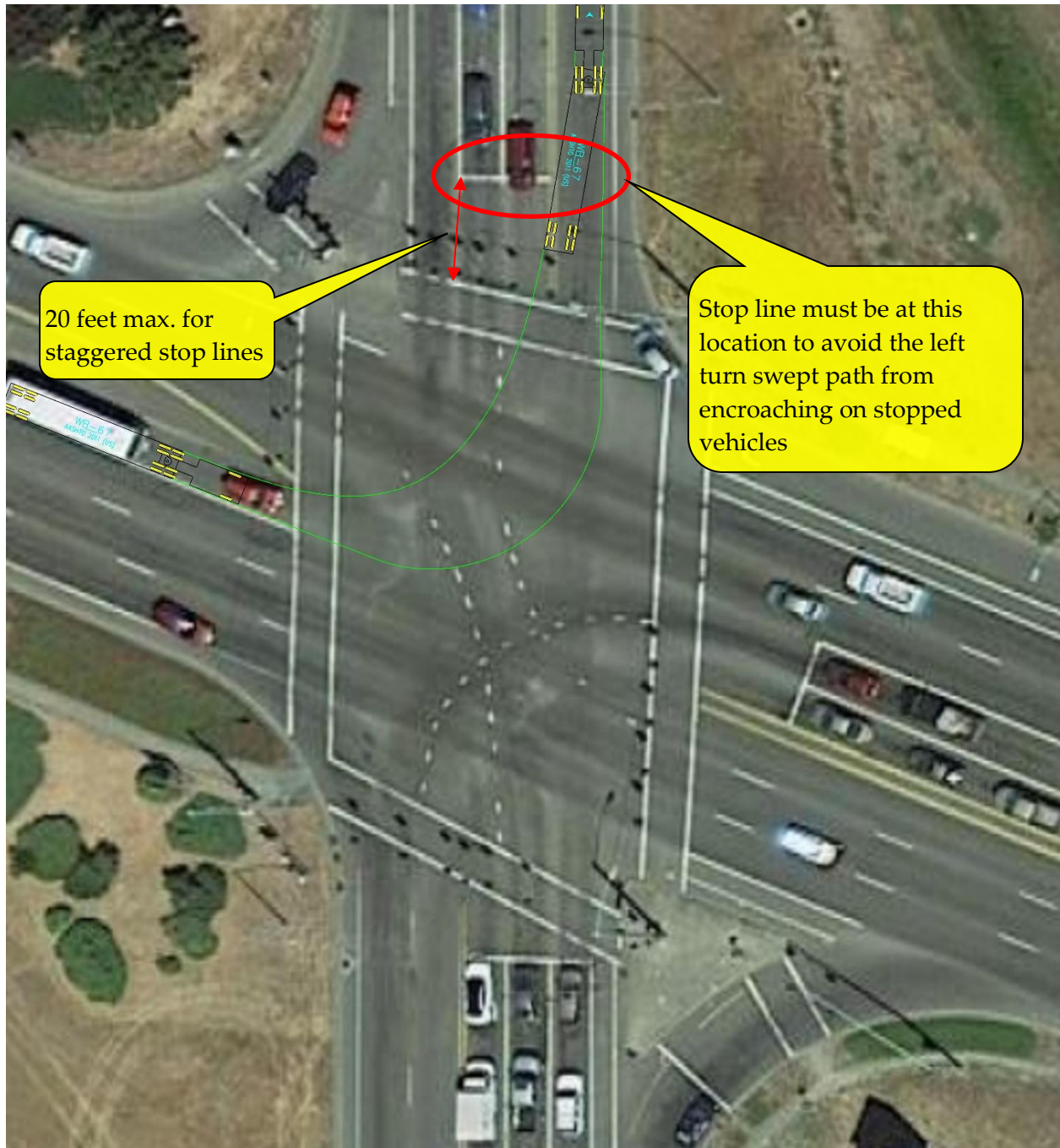


Figure 5-21 | Truck Turning Templates – Verifying Right Turns

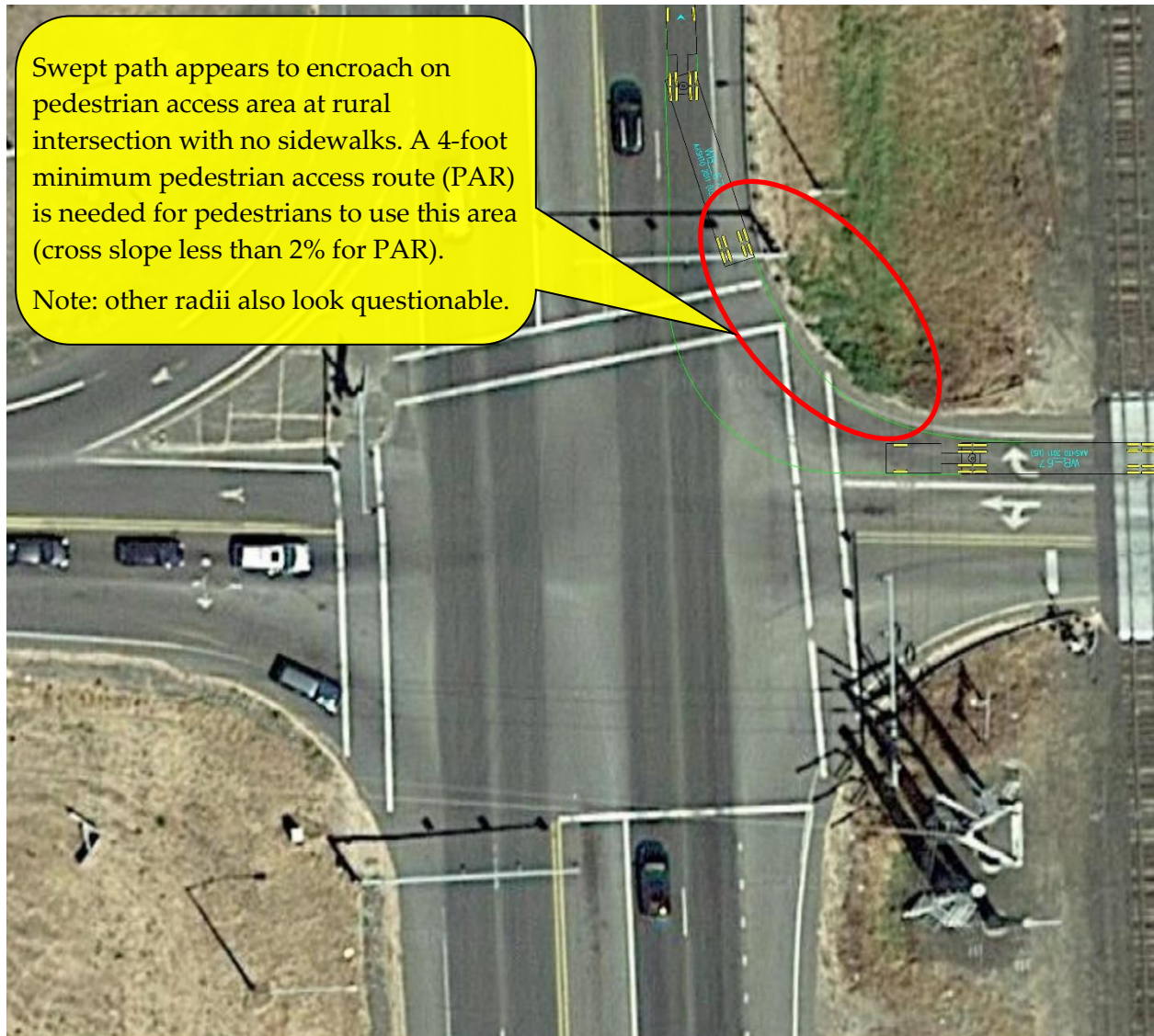
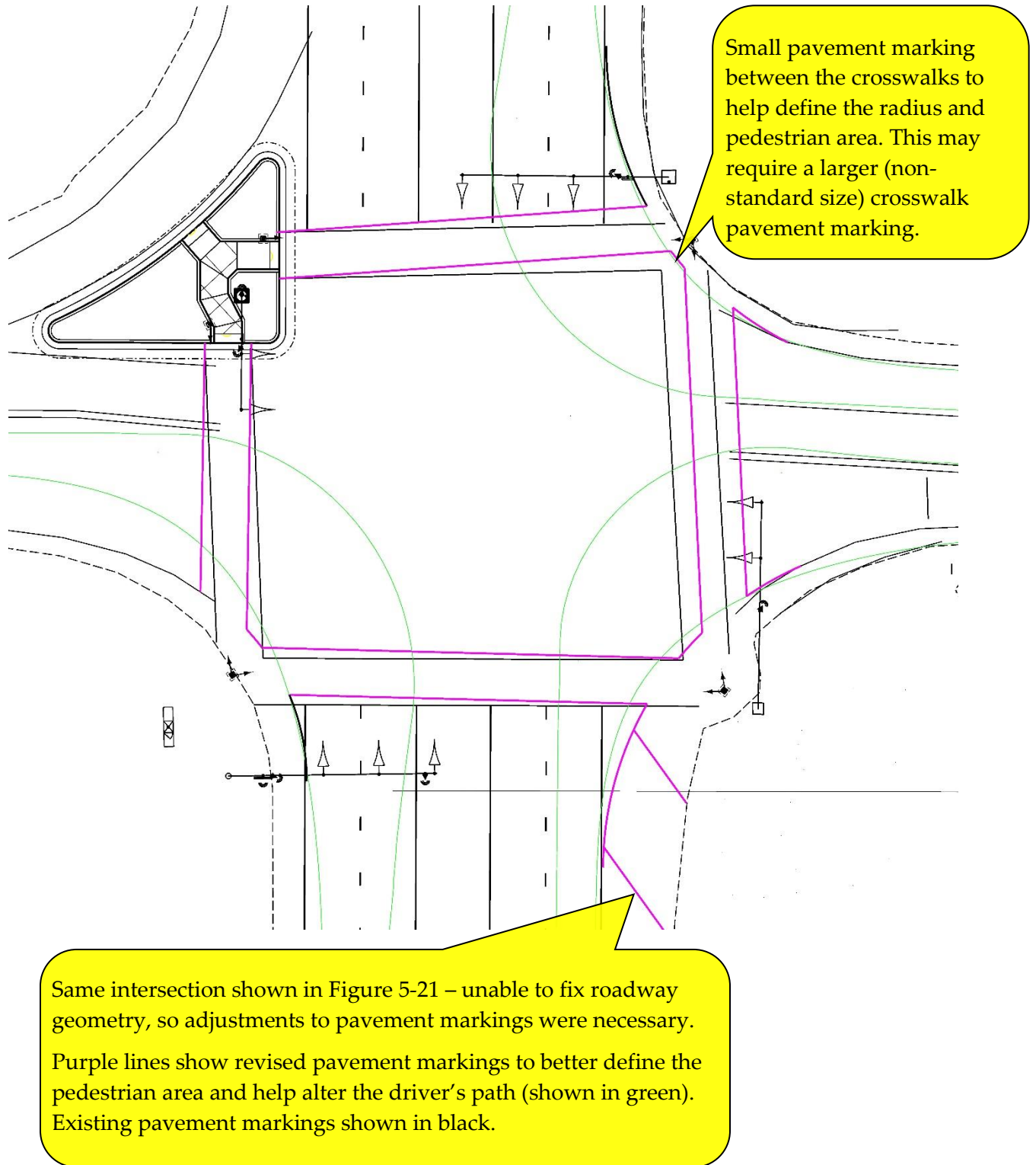


Figure 5-22 | Truck Turning Templates – Verifying Right Turns, Pavement Marking Adjustment



## 5.1.9 Lane Shift Through Intersection (Off-set lane lines)

It is important that approach lanes align well with their receiving lane. Drivers do not expect to make a steering correction when traveling through an intersection and may end up driving in areas they shouldn't if they don't recognize the lane shift in time. It also can be challenging to place signal heads in the correct location resulting in decreased visibility to the signal indications. Ideally there should no offset from the approach lane to the receiving lane through the intersection. The ODOT Highway Design Manual states a maximum of 4 feet offset is allowed through the intersection. If there is more than 4 feet of offset, fixing the roadway alignment or changes to lane use are recommended. See Figure 5-23 and Figure 5-24. If this is not feasible, a roadway general design exception and approval by the state traffic signal engineer is required. Extension pavement markings through the intersection may also be helpful, but these markings tend to wear fast and require more maintenance. See Figure 5-25.

Figure 5-23 | Lane Shift – Example 1

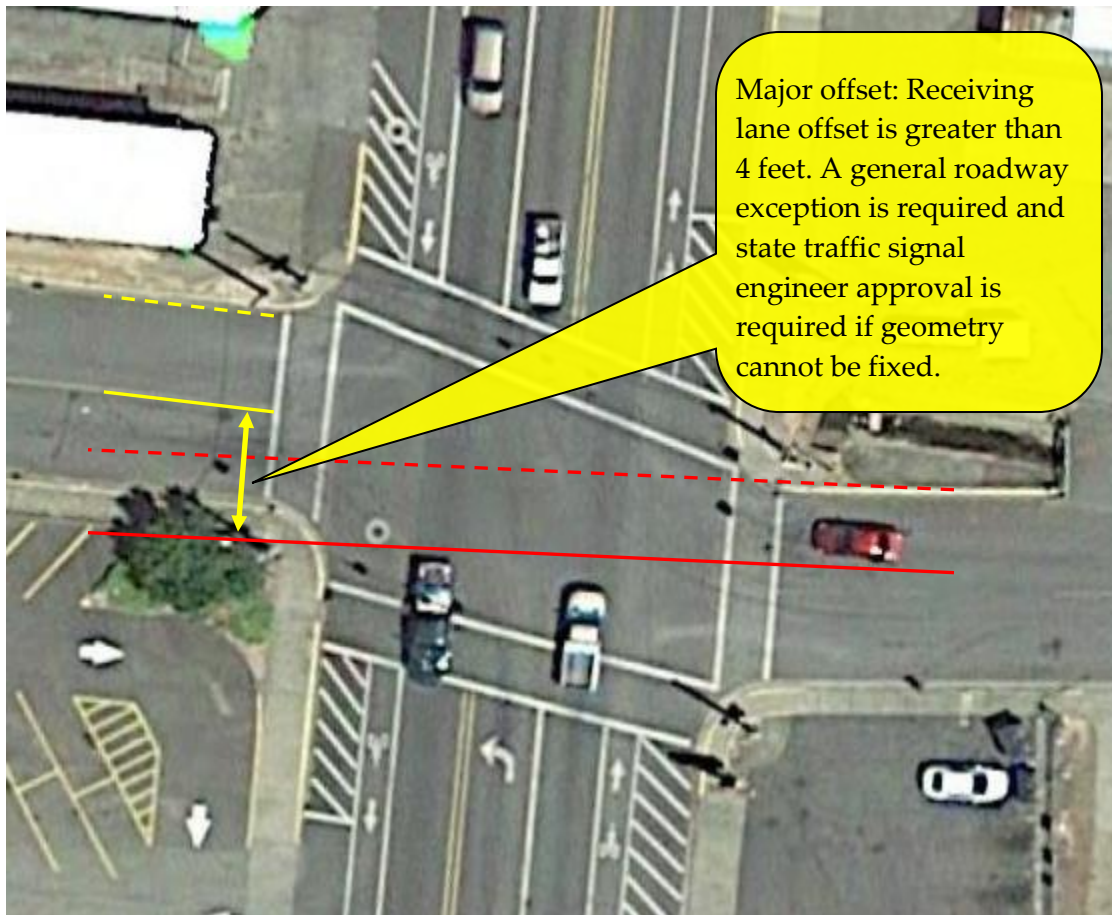


Figure 5-24 | Lane Shift – Example 2

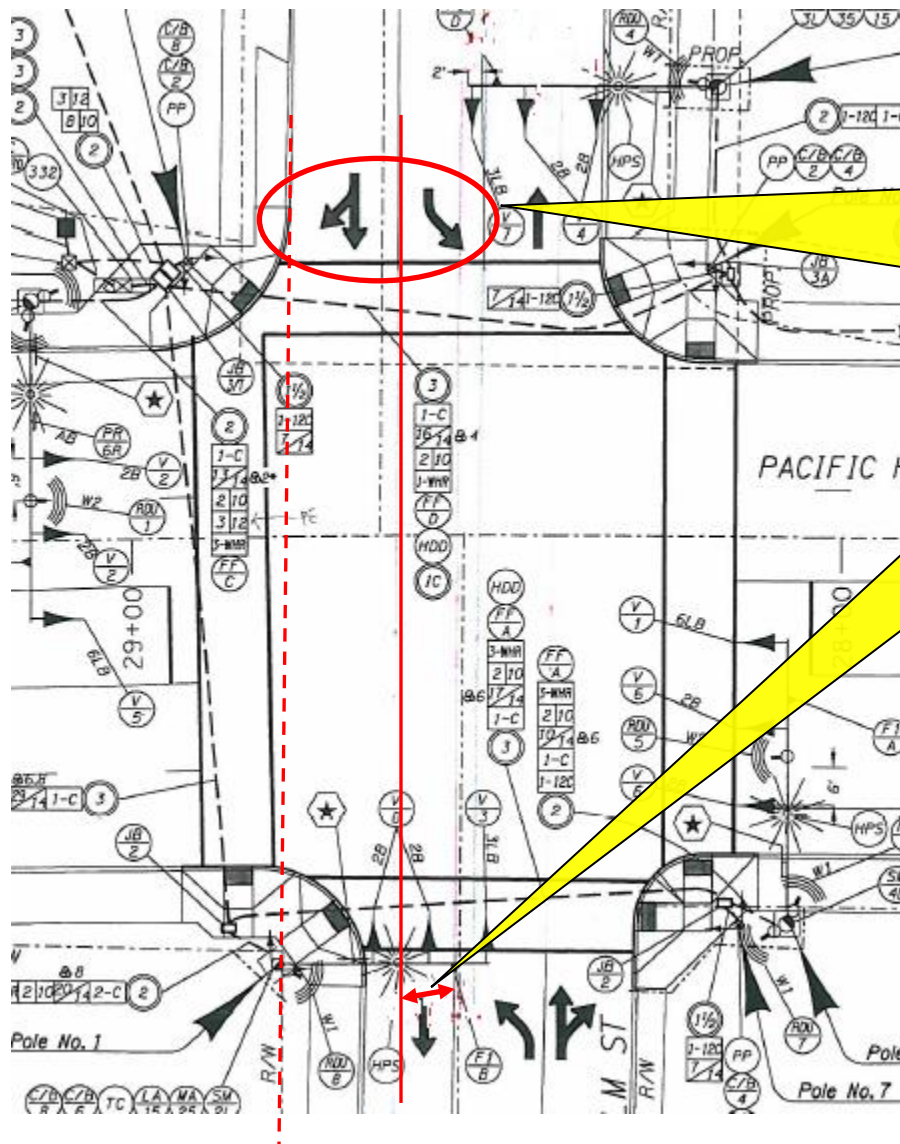
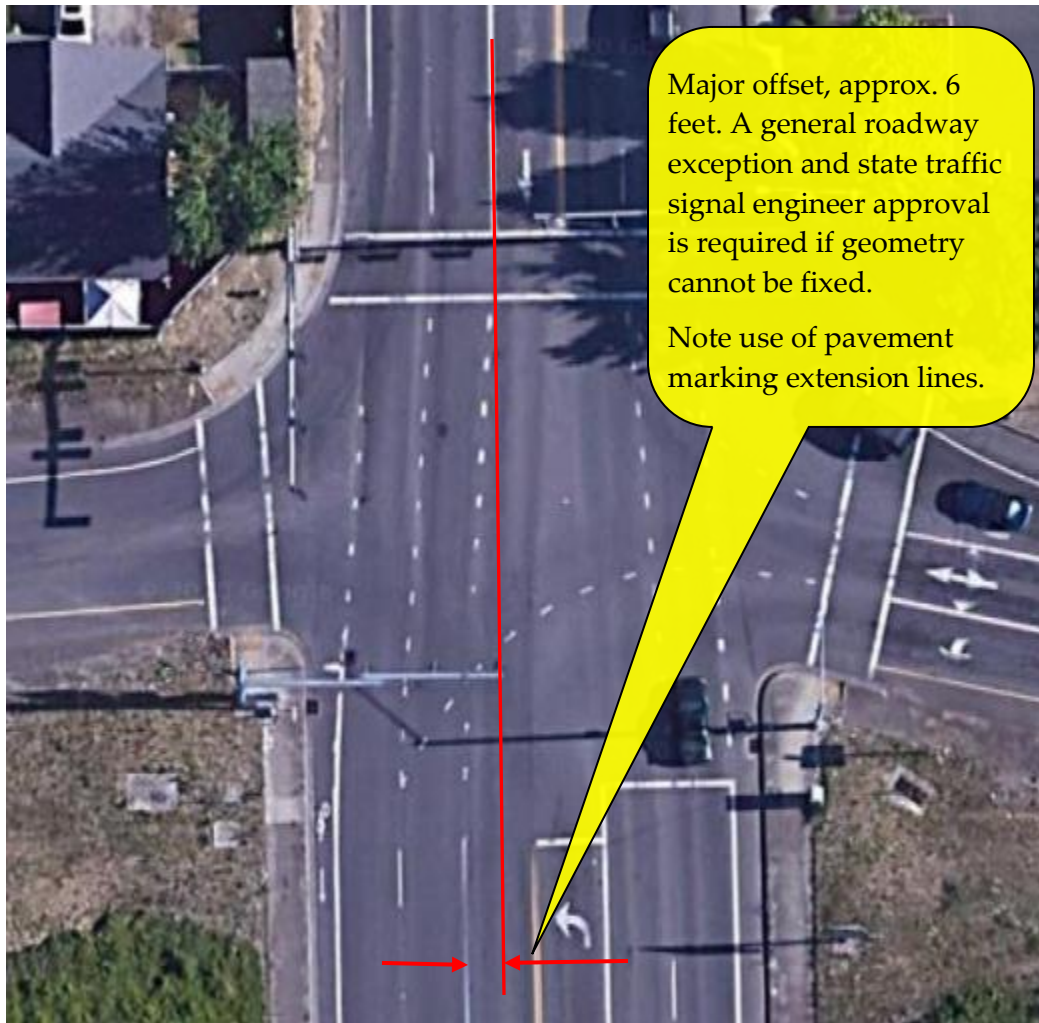




Figure 5-25 | Lane Shift – Example 3



## 5.2 Vehicle Signal Head Layout

Signal head location is guided by the Manual on Uniform Traffic Control Devices (MUTCD) and the Oregon Supplement to the MUTCD. Once the number of lanes, lane use, location of crosswalks, signal phasing and roadway geometry are known, the vehicle signal heads can be laid out. This, in conjunction with the pedestrian signal equipment layout (see Section 5.4), will be the basis for determining what type of signal support structures (mast arms, pedestals, or custom design) should be used at the intersection.

The operational approval and the roadway geometry MUST match!

Some basic guidelines per approach:

- Signal heads should be mounted overhead on mast arms (or span wires for temporary signals) for all movements. Supplemental signal heads may be ground mounted on pedestals.
- Signal heads should be aligned vertically (vs. horizontally).
- A minimum of two signal faces shall be provided for the through movement on the approach. If no through movement exists, a minimum of two signal faces shall be provided for the major movement from the approach.
- A signal face per lane shall be used when there are 3 or more through lanes on the approach.
- Heads for the same phase shall not be located closer than 8 feet apart (horizontally from each other). They should be located at least 10 feet apart when possible.
- Heads shall not be less than 45 feet (based on the standard 18 to 19 foot mounting height) from the “STOP” line (or nearside crosswalk line if there is no stop line). Heads located greater than 180 feet from the “STOP” line require a near-side supplemental head.

### 5.2.1 Head Types

The standard signal heads types that can be used for new construction are defined in standard drawing TM460 and shown in Figure 5-26. Head types are designated by a number or a combination of number and letter(s). Each signal head type has a specific use. Standard detail DET4401 contains signal head types that are either no longer used for new construction or their use is for a site-specific operation that is typically discouraged. See Figure 5-27. Use of this standard detail should only be necessary when replacing existing signal heads in-kind due to a very limited project scope that makes installing the current standard signal heads infeasible.

If the need arises to use a signal head type or layout that that is not covered by this manual, contact the state traffic signal engineer to discuss and resolve the unique situation. Also, see chapter 2 for more information on non-standard and experimental design.

Figure 5-26 | Standard Signal Head Types (TM460)



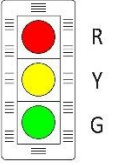
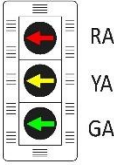


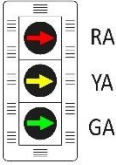
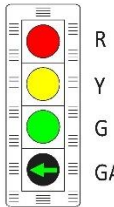
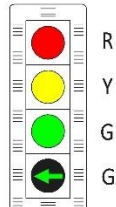
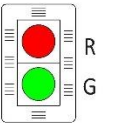
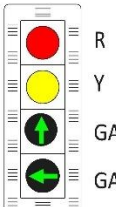

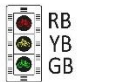
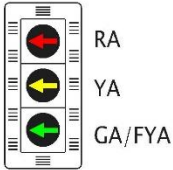

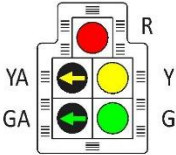
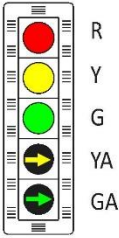
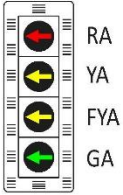
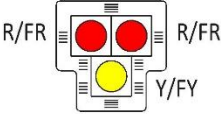
<p><b>TYPE 1R</b> Red flashing beacon</p>  <p>FR</p>	<p><b>TYPE 1Y</b> Yellow flashing beacon</p>  <p>FY</p>	<p><b>TYPE 2</b> Basic signal (allows through and permissive left &amp; right turns)</p>  <p>R Y G</p>	
<p><b>TYPE 3L</b> Left turn signal (protected only)</p>  <p>RA YA GA</p>	<p><b>TYPE 3LCF</b> Left turn signal (protected/permittted)</p>  <p>RA YA/FYA GA</p>	<p><b>TYPE 3R</b> Right turn signal (protected only: overlap phase)</p>  <p>RA YA GA</p>	<p><b>TYPE 3RCF</b> Right turn signal (protected/permittted)</p>  <p>RA YA GA</p> <p>See "proposed update for PPRT Type 3RCF signal head" document on the signal design manual webpage!</p>
<p><b>TYPE 4</b> Split phasing signal (protected left turn &amp; through move)</p>  <p>R Y G GA</p>	<p><b>TYPE 7</b> Railroad preemption signal (ONLY used when the track clearance phase has a permissive left turn)</p>  <p>R Y G GA</p>	<p><b>TYPE 8</b> Ramp meter</p>  <p>R G</p>	<p><b>TYPE 9</b> Split phasing signal (ONLY used with a specific lane use configuration)</p>  <p>R Y GA GA</p>
<p><b>TYPE 12</b> Bike signal (ONLY used for bike phases)</p>  <p>RB YB GB</p>	<p><b>TYPE 12M</b> Mini bike signal (ONLY used near-side for bike phases)</p>  <p>RB YB GB</p> <p>4" diameter indications</p>		
<p>Color Indication Abreviations. All Indications are 12" diameter unless otherwise noted.</p> <p>R = Red Circular Ball      RA = Red Arrow      FYA = Flashing Yellow Arrow      RB = Red Bike Symbol              Y = Yellow Circular Ball      YA = Yellow Arrow      FR = Flashing Red Circular Ball      YB = Yellow Bike Symbol              G = Green Circular Ball      GA = Green Arrow      FY = Flashing Yellow Circular Ball      GB = Green Bike Symbol</p>			

Figure 5-27 | Non-Standard Signal Head Types (DET4401) – Not for New Construction

<p><b>TYPE 3LBF</b> Left turn signal (protected/permited)</p>  <p>RA YA GA/FYA</p>	<p><b>TYPE 3U</b> U-turn signal (protected)</p>  <p>RUA YUA GUA</p> <p>RUA = Red U-Turn Arrow YUA = Yellow U-Turn Arrow GUA = Green U-Turn Arrow</p>	<p><b>TYPE 4L</b> "Doghouse" left turn signal (protected/permited)</p>  <p>R YA Y GA G</p>	<p><b>TYPE 5</b> right turn signal (protected/permited)</p>  <p>R Y G YA GA</p>
<p><b>TYPE 6L</b> Left turn signal (protected/permited)</p>  <p>RA YA FYA GA</p>	<p><b>TYPE 10</b> Pedestrian hybrid beacon (PHB)</p>  <p>R/FR R/FR Y/FY</p>	<p><b>Not used for new construction unless approved by the state traffic signal engineer during the design review.</b></p>	

## 5.2.2 Head Placement

The even phases (ph. 2, ph. 4, ph. 6, and ph. 8) are typically the through movements. These phases typically require two type 2 heads. The location of the heads depends on the number of receiving lanes and the roadway geometry. See Table 5-1. The alignment of the through signal heads is based on the receiving lanes (Figure 5-28), NOT the projected approach lanes (Figure 5-29).

Table 5-1 | Standard Signal Heads for Through Movement Phases

<b>Standard Signal Heads for Through Movement Phases</b>	
<b>Number of receiving lanes</b>	<b>Number and placement of signal heads</b>
Single receiving lane	Two type 2 signal heads, placed one foot inside the projected receiving lane lines
Two receiving lanes	Two type 2 signal heads, one placed in the center of each receiving lane
More than two receiving lanes	One type 2 signal head for each receiving lane, placed in the center of each receiving lane

Signal head alignment for THROUGH movements are based on the RECEIVING lane lines (See Figure 5-28).

Signal head alignment for TURN movements are based on the PROJECTED lane lines (See Figure 5-32 and Figure 5-33).

Figure 5-28 | Signal Head Placement For Through Movement Using Receiving Lane Lines (CORRECT METHOD)

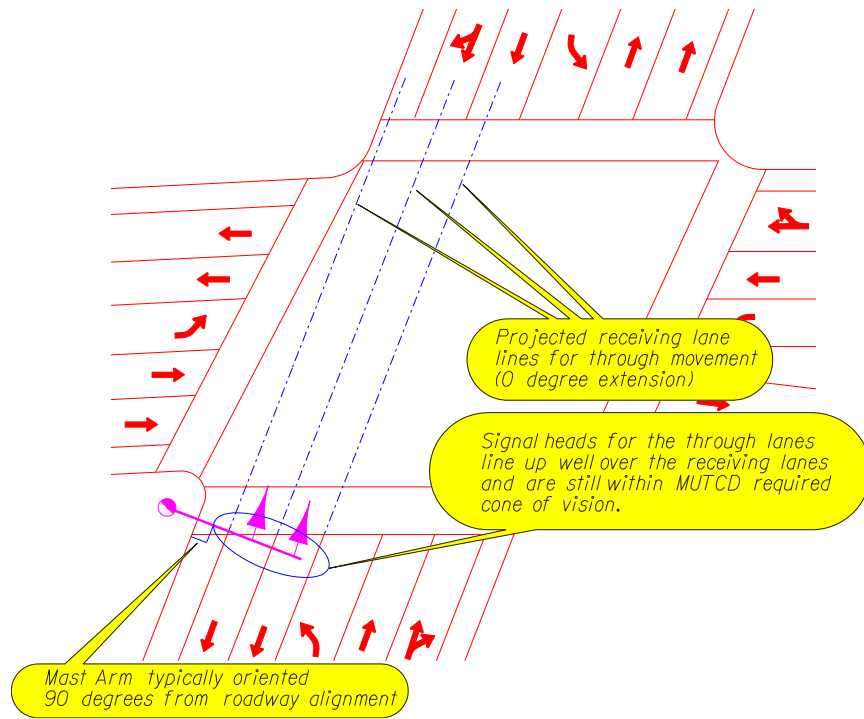
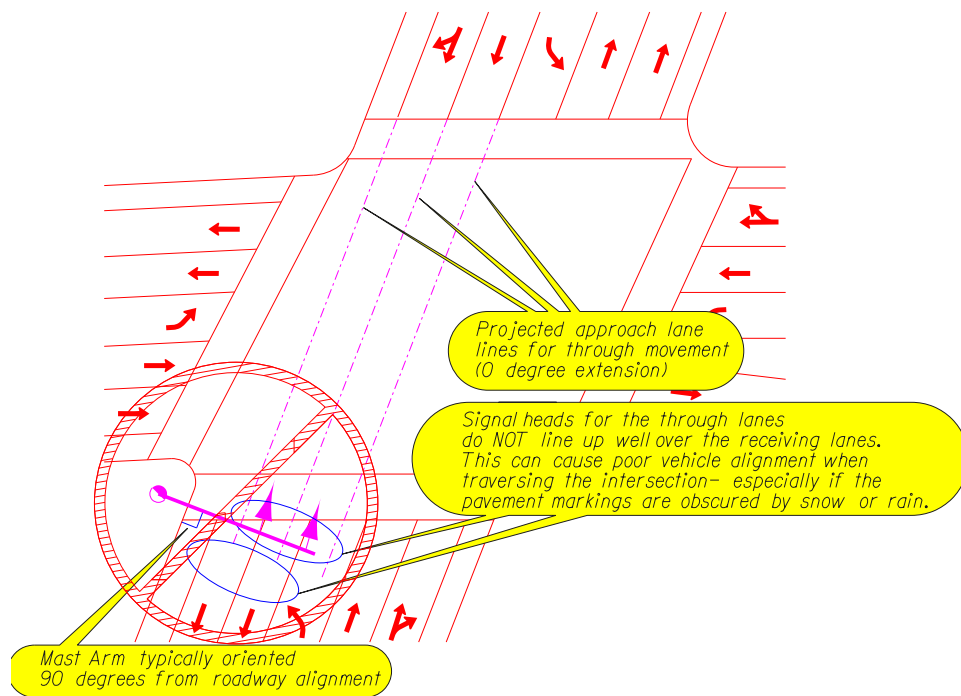


Figure 5-29 | Signal Head Placement For Through Movement Using Projected Lane Lines (INCORRECT METHOD)



When the intersection is located within a horizontal curve, strict adherence to signal alignment based on the receiving lane lines (through movements) and projected lane lines (turn movements) may not be possible; it could result in the left turn heads being located to the right of the through movement heads in one direction and the left turn heads being located to the left of the through movement heads by a ridiculous distance in the other direction. In these cases, the signal head alignment for the through phases takes precedence and should be determined first, according to the receiving lane lines. This is because the through movements are more likely to be approaching and proceeding through the intersection at speed, while the turn movements are more likely to be coming to a stop and will proceed through the intersection at a slower speed. The turn signal head alignment is determined next, with the left turn head always located to the left of the through movement heads and the right turn heads always located to the right of the through movement heads, regardless of the projected lane lines. The turn signal heads should be kept within a reasonable distance of the through movement heads if possible, approximately 6 to 12 feet. See Figure 5-30 and Figure 5-31.

Figure 5-30 | Horizontal Curves and Signal Head Alignment, Example 1

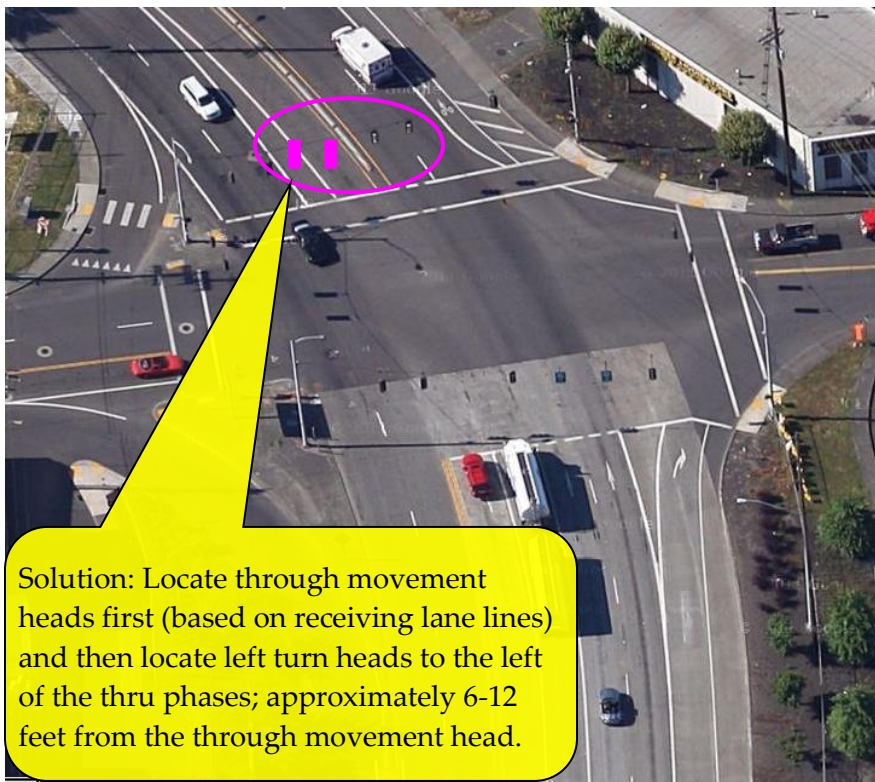
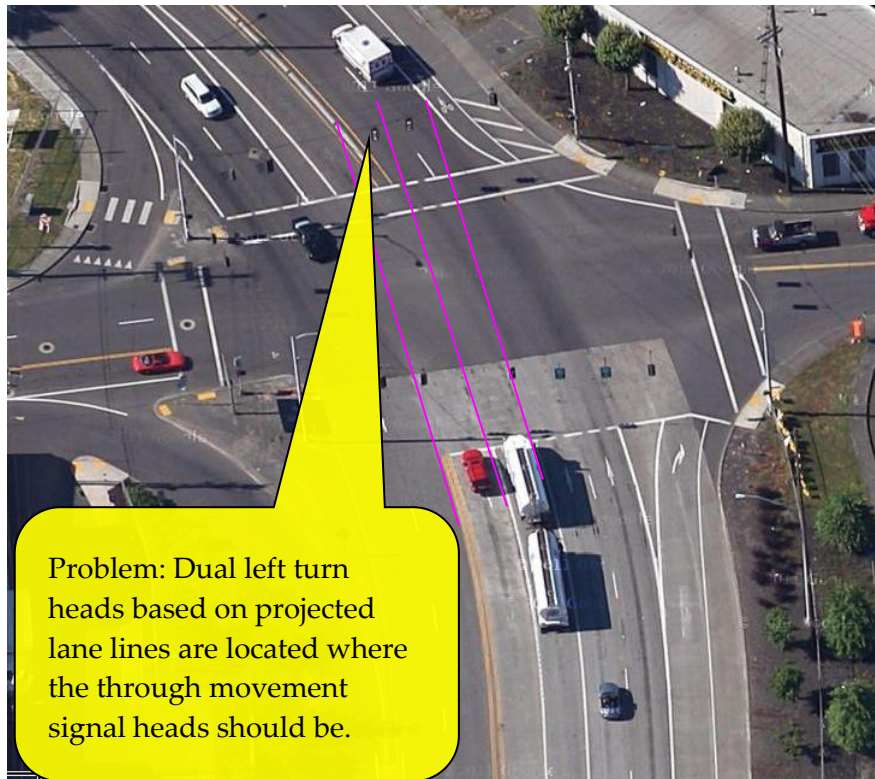
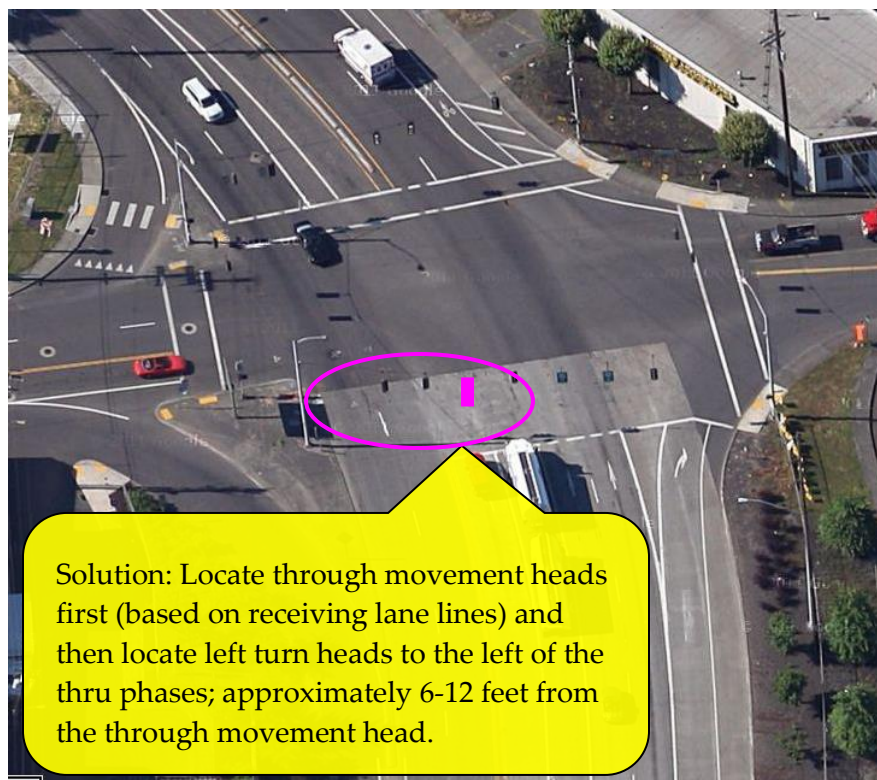




Figure 5-31 | Horizontal Curves and Signal Head Alignment, Example 2



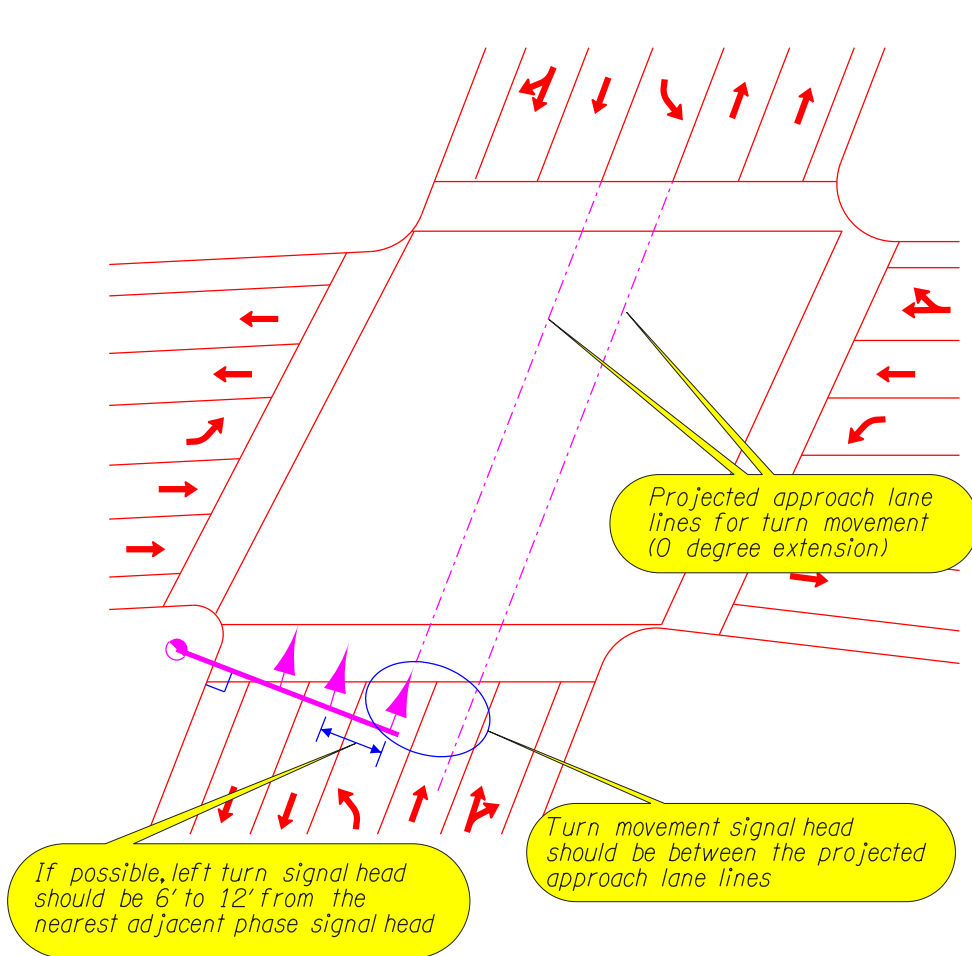
The odd phases (ph. 1, ph. 3, ph. 5, and ph. 7) are typically the left turn movements. These phases typically require one signal head. Dual turn movements require two signal heads. The signal head type will depend on the operation of the left turn phase as stated in the operational approval. The alignment of the left turn signal heads is based on the projected approach lanes. See Table 5-2 and Figure 5-32.

Table 5-2 | Standard Signal Heads for Left Turn Phases

<b>Standard Signal Heads for Left Turn Phases</b>	
<b>Type of Operation</b>	<b>Number and placement of signal heads</b>
Protected only phasing	One type 3L signal head, placed in the center of the projected lane lines*
Protected/permitted phasing	One type 3LCF signal head, placed in the center of the projected lane lines.* The type 3LBF, 4L and 6L heads are no longer used. <b>The location of the type 3LCF needs to be inventoried by the state traffic operations engineer until the adoption of the next version of the MUTCD.</b>
	Only for a shared through-left turn lane: One type 4L (doghouse) signal head, use signal head placement as described for through movement phases. Note: This operation and use of a type 4L head is discouraged – providing a left turn only lane with a standard type 3LCF signal head is preferred.
Permissive only phasing (Note: applicable when dual left turns are allowed at an intersection where both streets are one-way)	Signal head PROHIBITED from being located within the left turn only lane projected lane lines. Use signal head placement as described for through movement phases.
Dual left turns (protected only phasing)	Two type 3L signal heads, one placed in the center of each projected lane lines*

\* If possible, left turn phase signal heads should be located within 6 to 12 feet of the nearest adjacent phase signal head.

Figure 5-32 | Signal Head Placement for Left Turn Phases Using Projected Lane Lines



Right turn movements are typically permissive only, and as such require no additional signal heads. However, if a right turn only lane is to be operated other than permissive only, the signal head type will depend on the desired operation as stated in the operational approval. Dual turn movements require two signal heads. The alignment of the signal heads is based on the projected approach lanes, with the exception of right turn slip-lanes. See Table 5-3 and Figure 5-33.

Table 5-3 | Standard Signal Heads for Right Turn Phases

<b>Standard Signal Heads for Right Turn Phases</b>	
<b>Type of Operation</b>	<b>Number and placement of signal heads</b>
Protected only phasing (Overlap)	One type 3R signal head, placed in the center of the projected lane lines*.
Protected/permitted phasing Use of this operation is discouraged (for operational and/or hardware issues). Preferred options include: <ul style="list-style-type: none"> <li>• Providing the requirements to use a type 3R signal head</li> <li>• Operating the right turn as permissive only</li> </ul>	One type 5 signal head, placed in the center of the projected lane line*. This is a 2-phase signal head. One type 3RCF signal head, placed in the center of the projected lane line*. <i>See the “Proposed Update for PPRT Type 3RCF Signal Head” document on the <a href="#">traffic signal design manual website</a> if using this signal head.</i>
Permissive only phasing (Note: applicable when dual left turns are allowed at an intersection where both streets are one-way)	No signal head required. Use signal head placement as described for through movement phases.
Dual right turns (protected only phasing)	Two type 3R signal heads, one placed in the center of each projected lane lines*.
Signalized right turn slip lanes, single lane (protected only phasing)	Two type 3R signal heads, placed one foot inside the approach lane line.
Signalized right turn slip lanes, dual lanes (protected only phasing)	Two type 3R signal heads, one placed in the center of each approach lane.
<b>NOTE: When installing a type 3R signal head these requirements apply (see Figure 5-38):</b> <ul style="list-style-type: none"> <li>• Negative ped phasing is required, or the conflicting crosswalk must be closed.</li> <li>• If the opposing left turn phasing is permissive only or protected/permissive, a separate receiving lane for the left and right turn movements is required (MUTCD 4D.05F, 1)</li> </ul>	

\* If possible, right turn phase signal heads should be located within 6 to 12 feet of the nearest adjacent phase signal head.

Figure 5-33 | Signal Head Placement for Right Turn Phases Using Projected Lane Lines

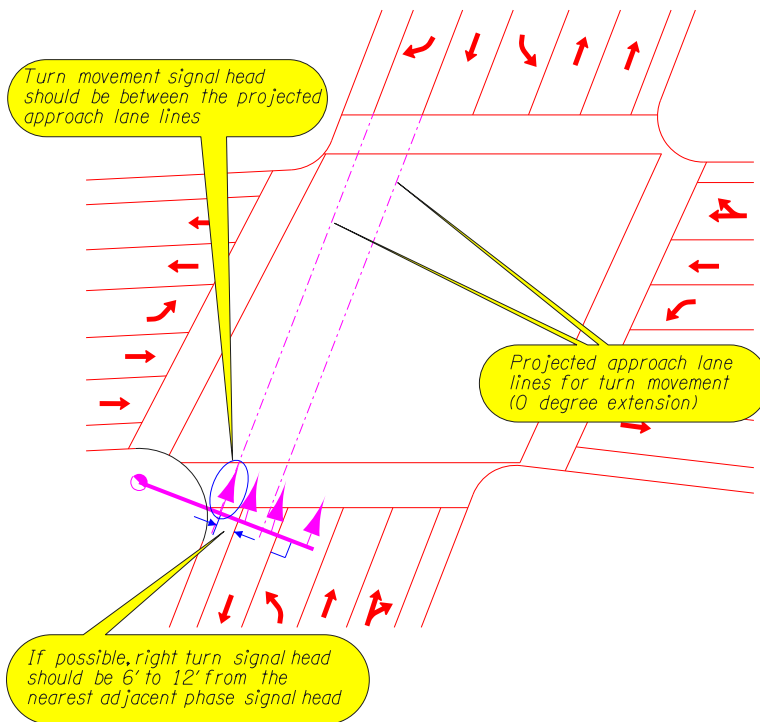
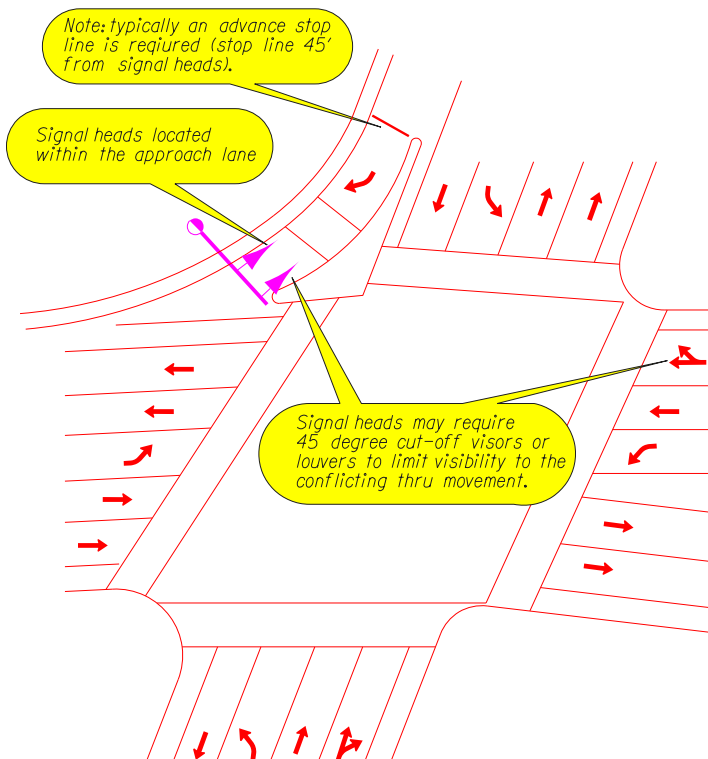


Figure 5-34 | Signal Head Placement for Right Turn Phases –Right Turn Slip Lanes



There are a few special signal phasing/lane configurations that are noted below. While they are not used frequently, they are not uncommon and therefore have standards associated with them. See Table 5-4.

Table 5-4 | Standard Signal Heads for Special Phasing/Lane Configurations

<b>Signal Heads for Special Phasing/Lane Configurations</b>	
<b>Type of Operation</b>	<b>Number and placement of signal heads</b>
Split phasing	A type 4, 3L or 9 signal head is required if the approach has a left turn movement. The signal type is dependent on the lane use. See Figure 5-39 and Figure 5-40
Approach with a vehicle clear-out interval (railroad preemption) AND a permissive left turn phase.	A type 7 signal head is required, placed as shown in Figure 5-41

Figure 5-35 through Figure 5-41 show examples of typical signal head placements.

Figure 5-35 | Signal Head Placement for Lanes Sharing the Same Phase

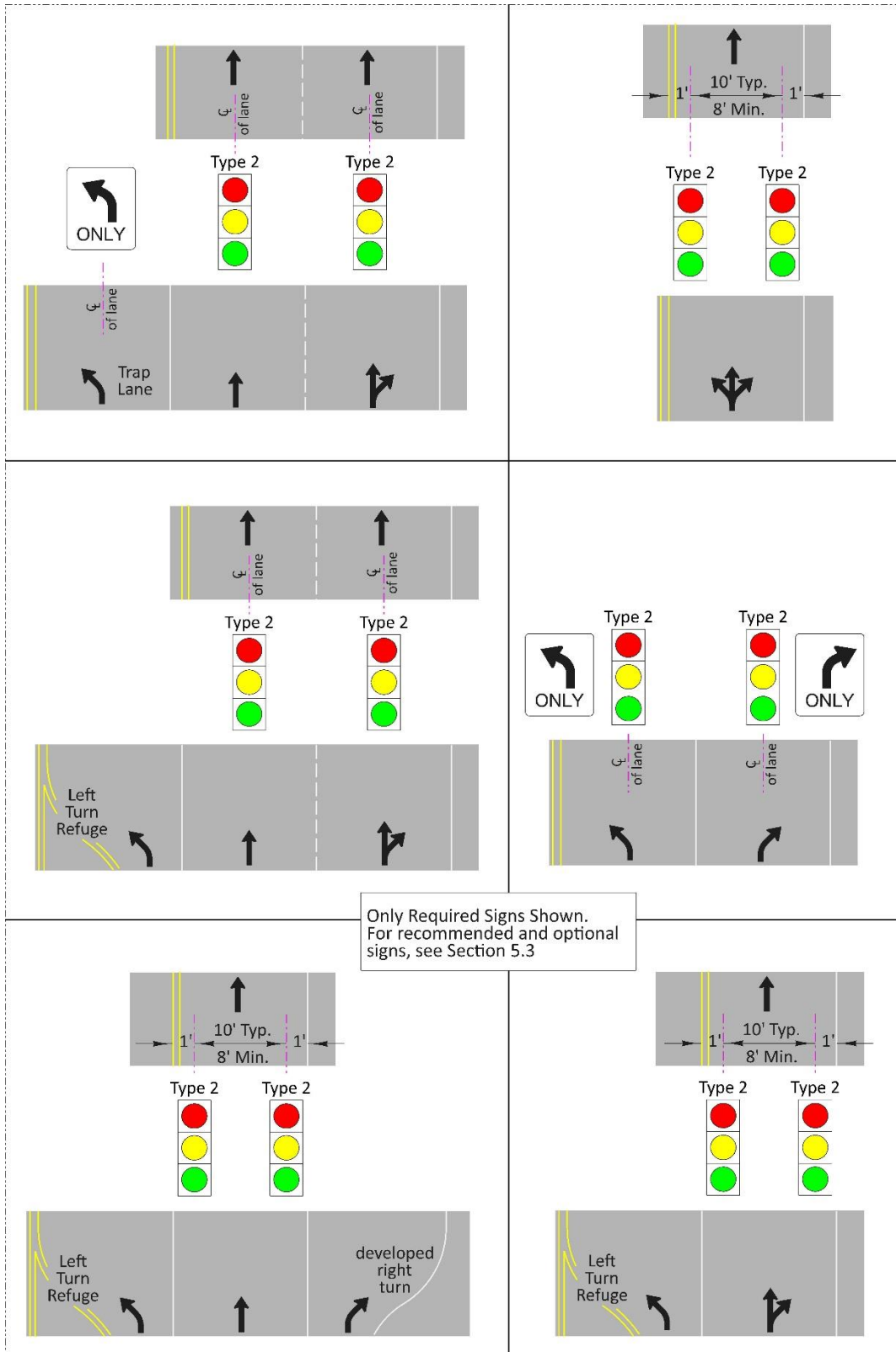


Figure 5-36 | Signal Head Placement for Lanes Sharing the Same Phase (cont.)

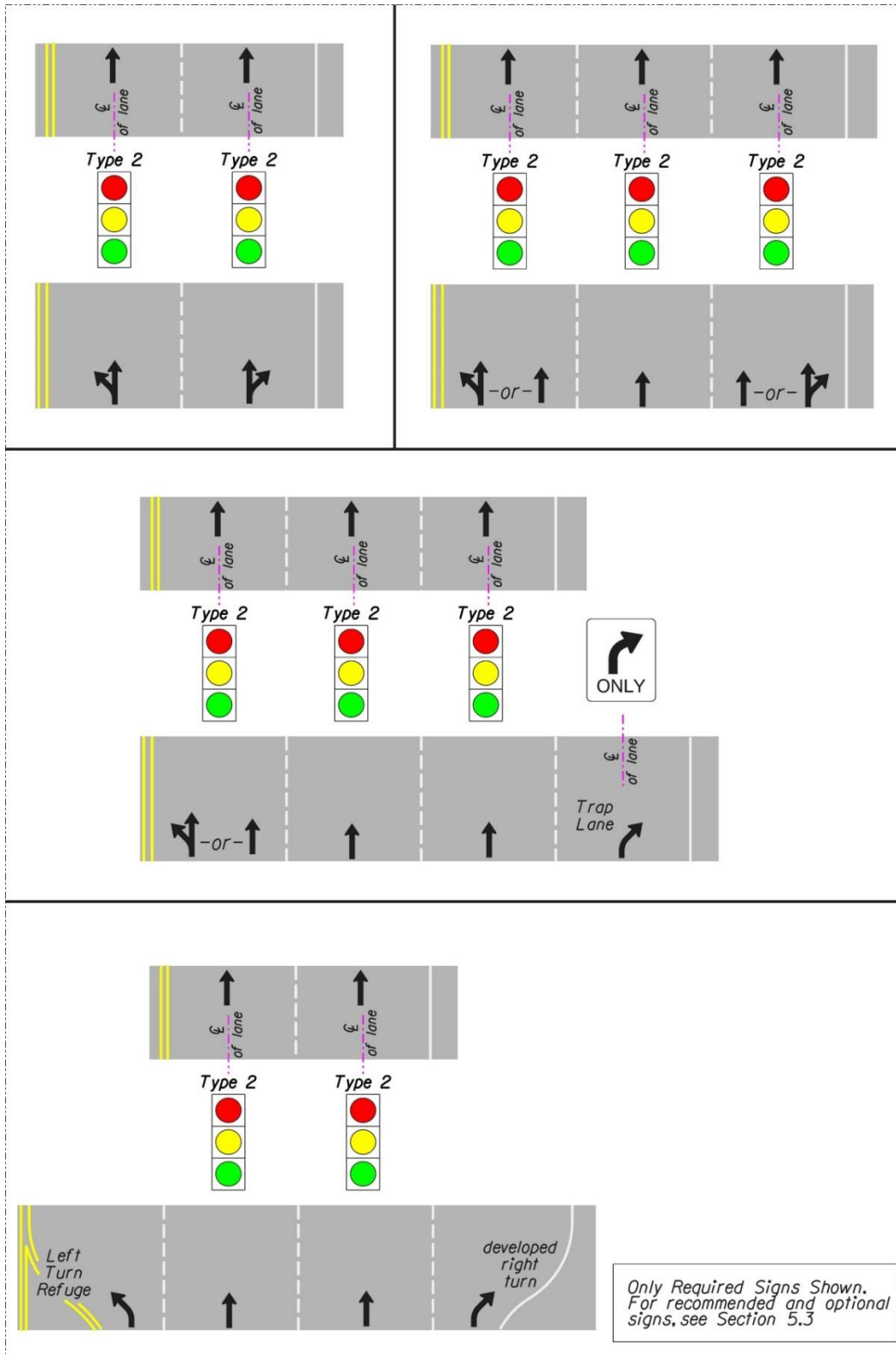




Figure 5-37 | Signal Head Placement for Left Turn Phasing

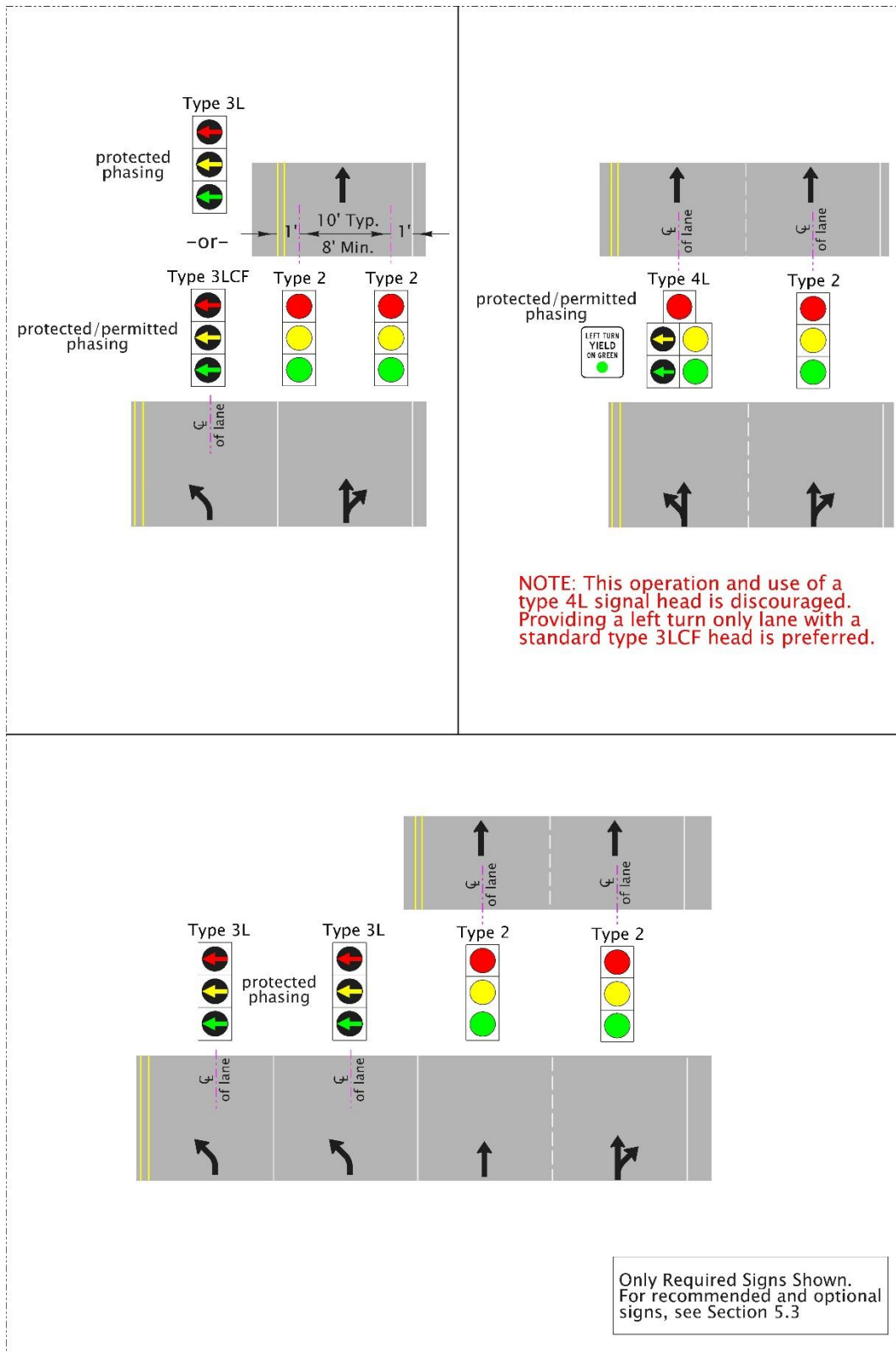


Figure 5-38 | Signal Head Placement for Right Turn Phasing

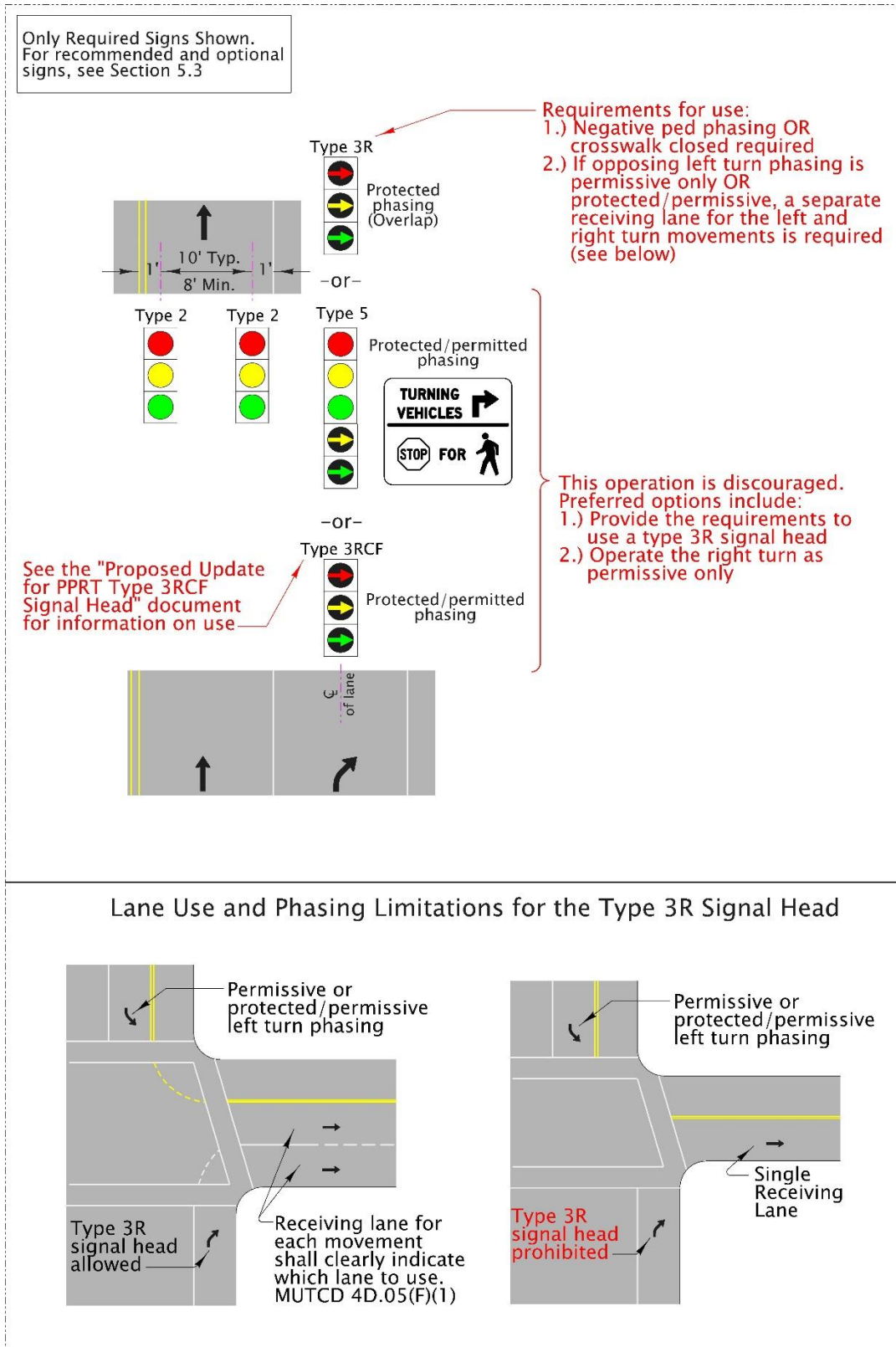


Figure 5-39 | Signal Head Placement for Split Phasing

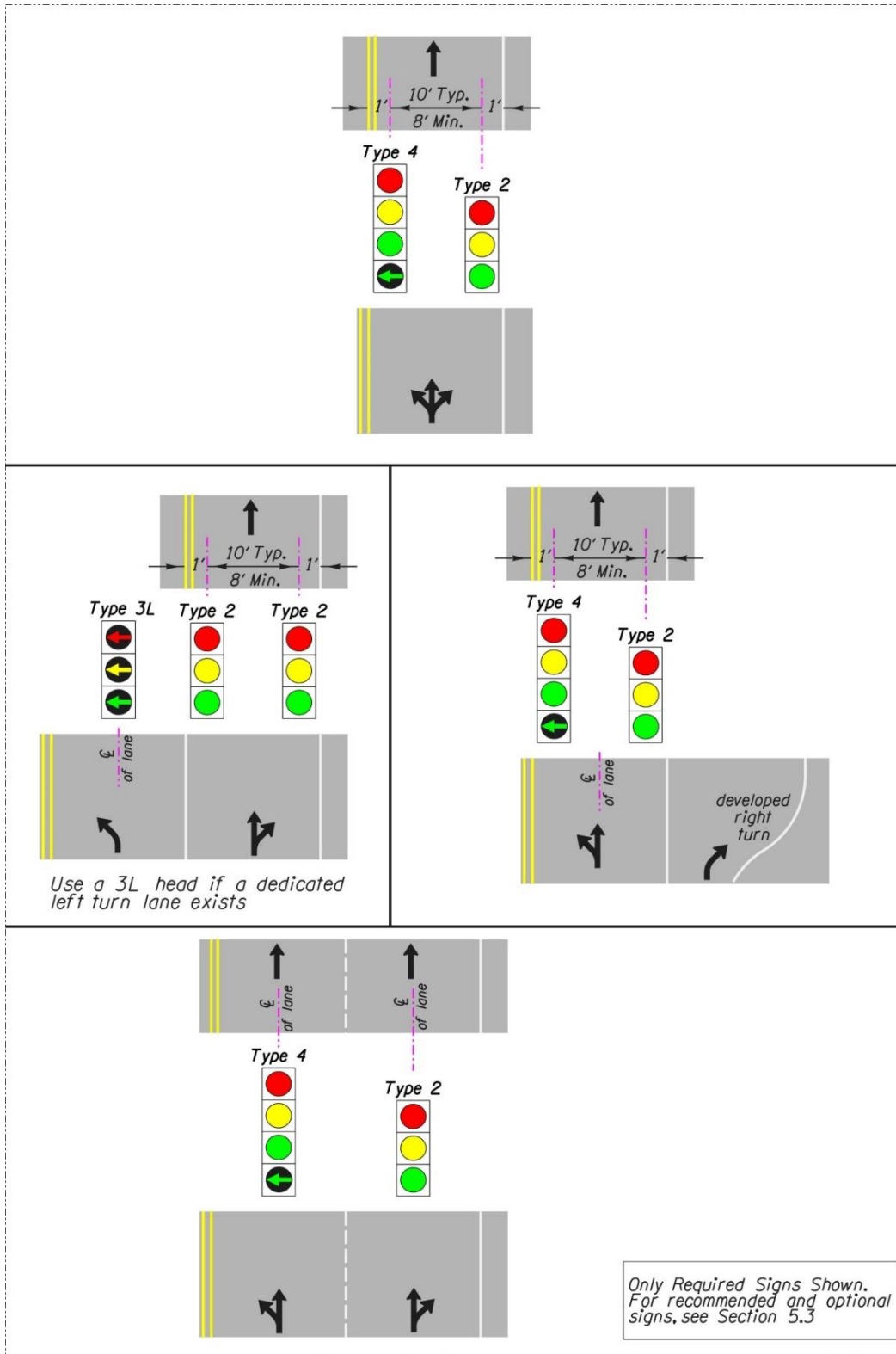


Figure 5-40 | Signal Head Placement for Split Phasing (cont.)

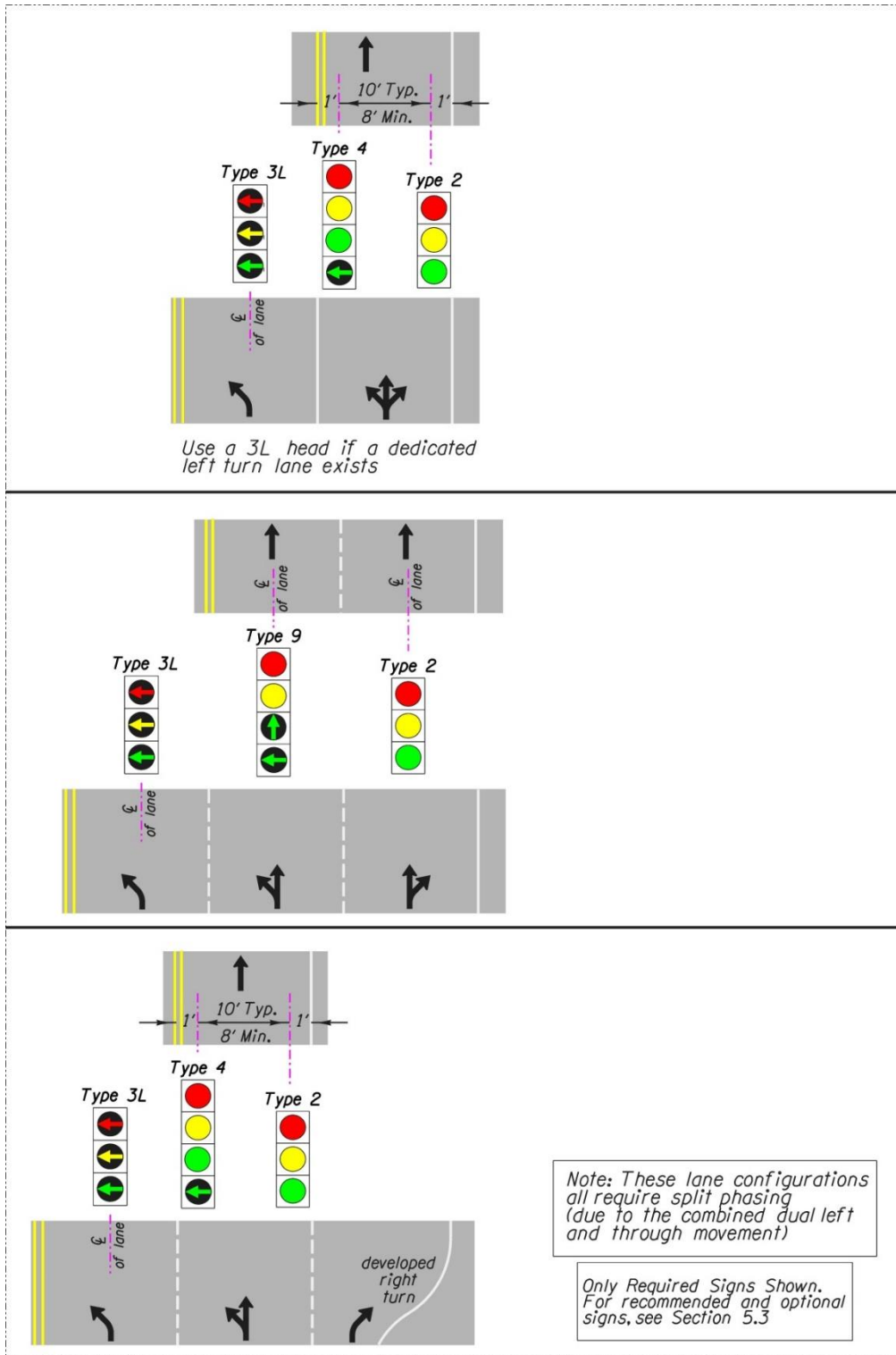
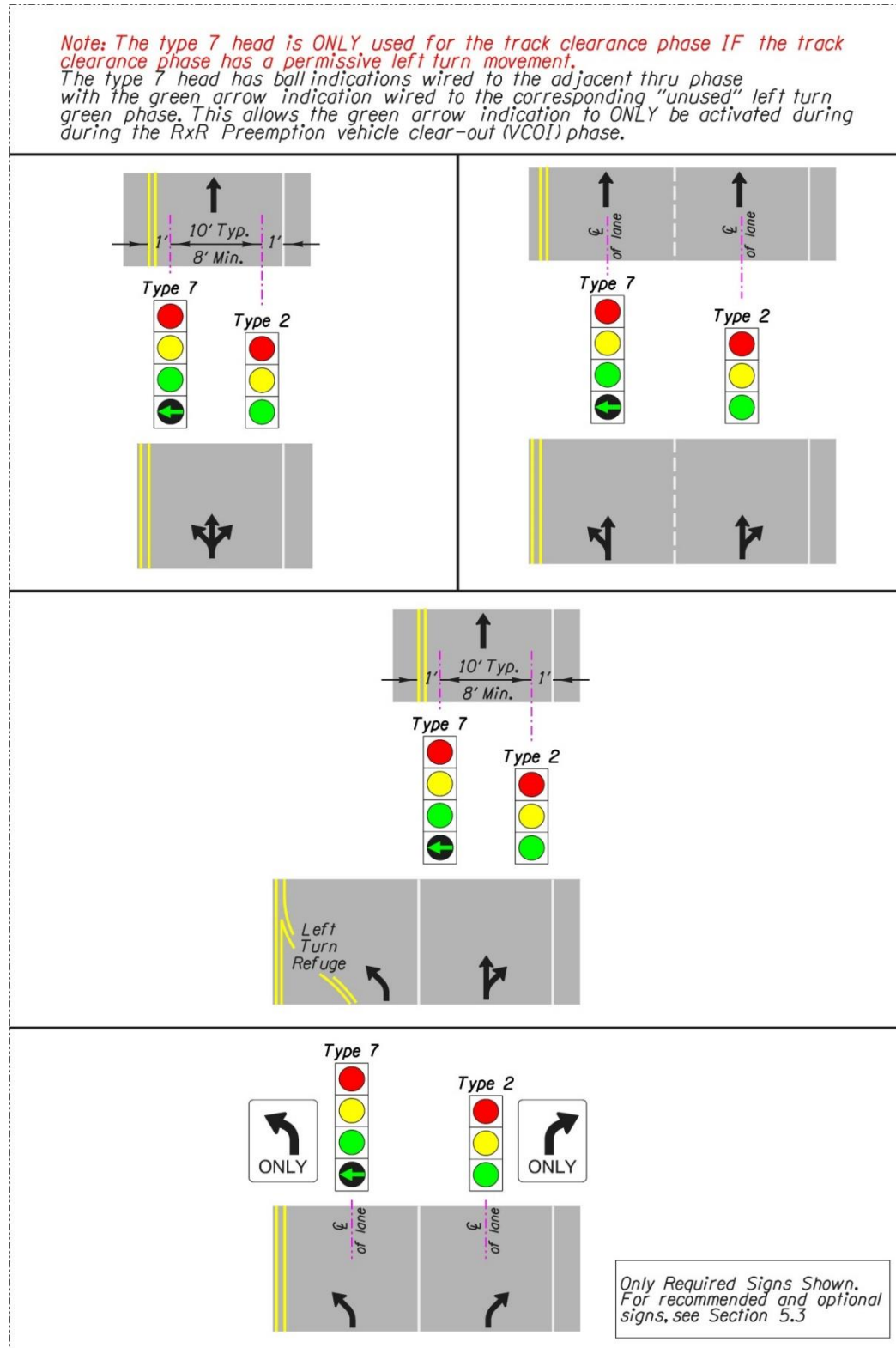


Figure 5-41 | Signal head Placement for Railroad Preemption



## 5.2.3 Supplemental signal heads

As per the MUTCD, supplemental near side signal heads are required when signal heads are located greater than 180 feet from the stop line. They may also be used to improve conspicuity and visibility to the signalized intersection. Supplemental signal heads are not wired to an independent phase (overlap phase), they are hardwired to phase they are supplementing. There are two main locations where supplemental signal heads can be placed:

- Near-side supplemental heads: signal heads are located before the intersection. This is the most common location, and typically will be for the thru phase. See Figure 5-42. It may also be used for left turn phases. See Figure 5-43. The head will be on the vertical signal pole (left or right side of the road, depending on the roadway curvature) or overhead if the supporting structure allows proper alignment (e.g. the mast arm is long enough).
- Far-side supplemental heads: signal heads are located across the intersection. This location is not as common as the near-side location. The typical application is for left turn phases. See Figure 5-45. It may also be for thru phases. See Figure 5-44. The head will be on the vertical signal pole (on the left side for a left turn phases, or on the right side for a thru phase).

Figure 5-42 | Supplemental Near-Side Signal Heads – Typical Placement for Thru Phase

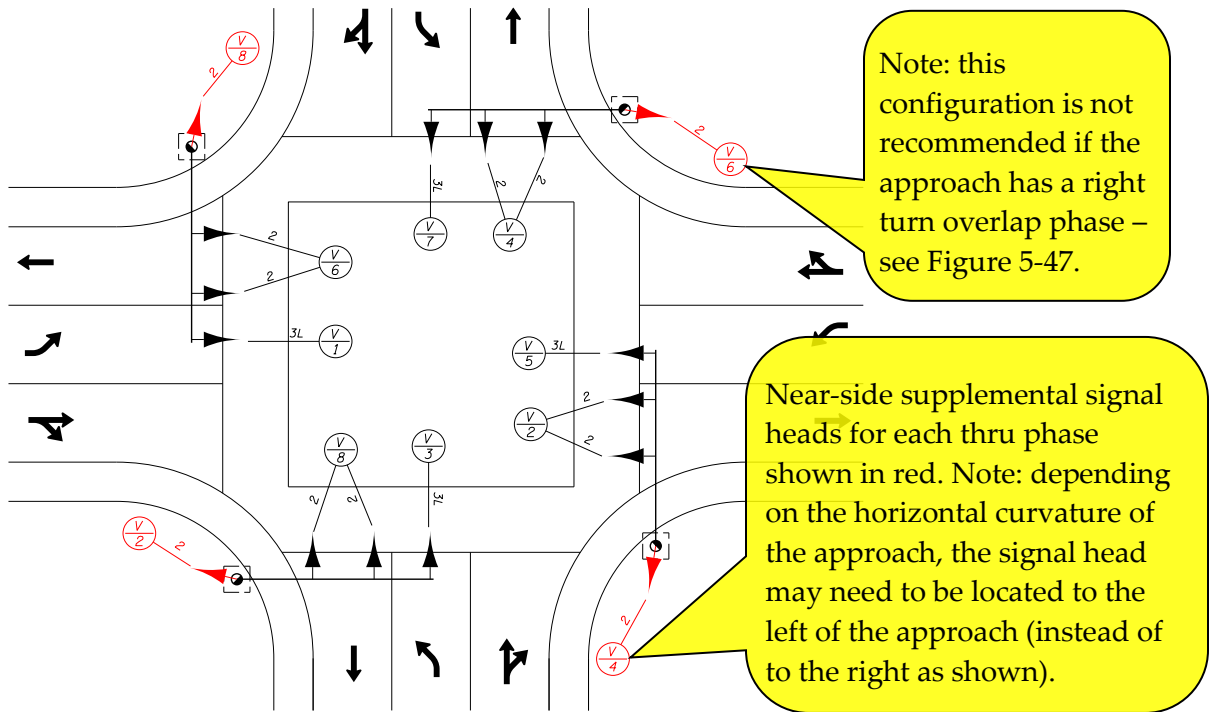


Figure 5-43 | Supplemental Near-Side Signal Heads – Typical Placement for Left Turn Phase

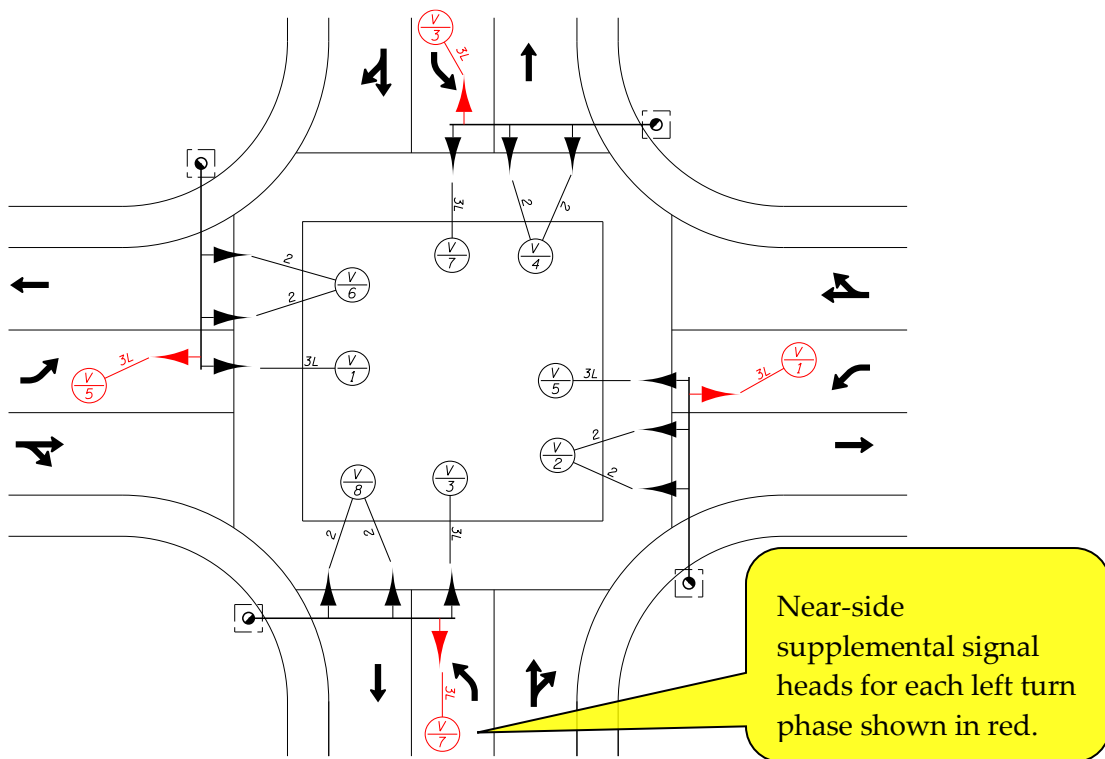


Figure 5-44 | Supplemental Far-Side Signal Heads – Typical Placement for Thru Phase

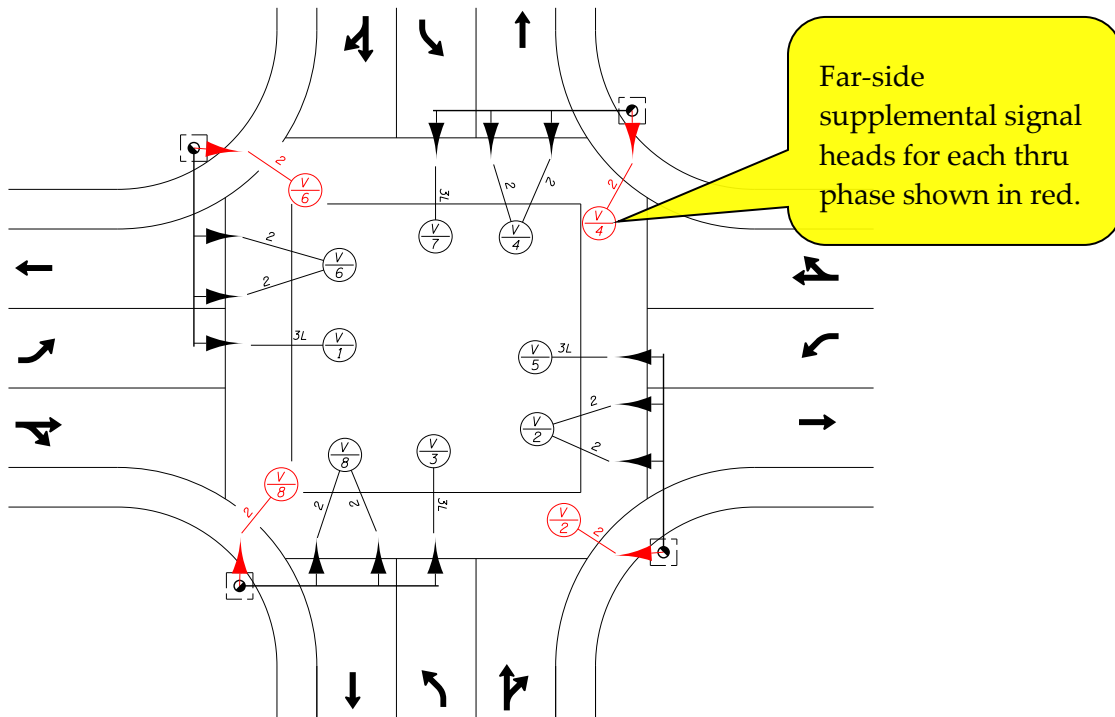
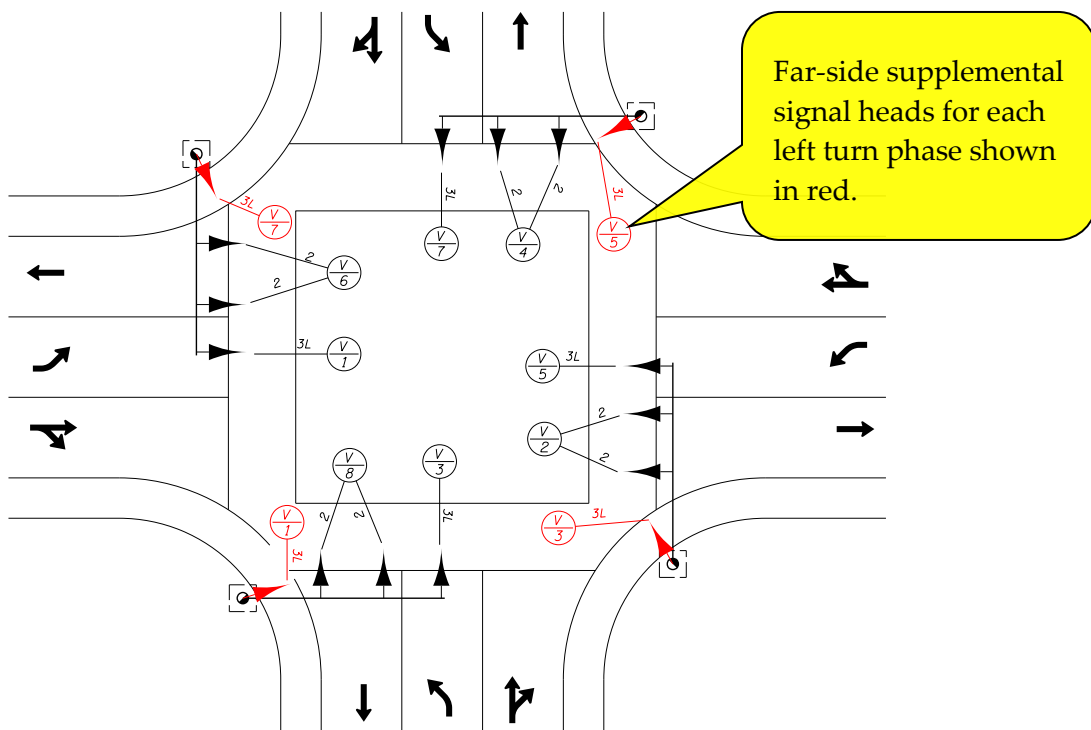


Figure 5-45 | Supplemental Far-Side Signal Heads – Typical Placement for Left Turn Phase





The use and placement of supplemental heads needs to be carefully considered to avoid motorist confusion. Supplemental signal heads can be very beneficial if the signal phasing and geometry allow proper placement. See Figure 5-46. However, there are situations where they should not be installed. For example, near-side supplemental heads should not be used on the right side of the road for the thru movement of an approach that has a right turn only lane with overlap phasing (e.g., the right turn lane is phased differently than the thru phase). See Figure 5-47 which illustrates the potential confusion. Louvers and cut-off visors can help in some situations (see section 5.2.5).

Figure 5-46 | Supplemental near-side signal head placement: Example 1

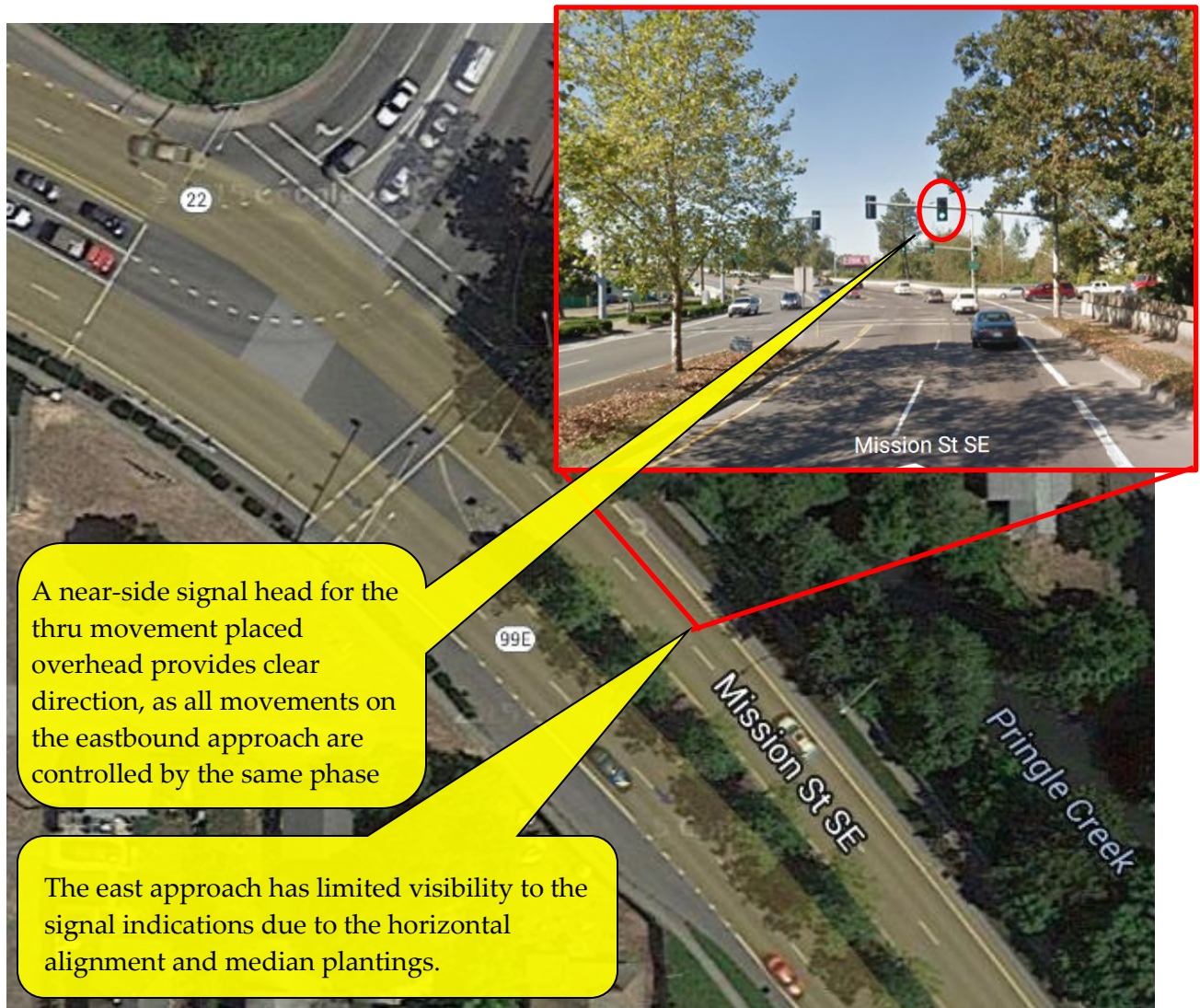
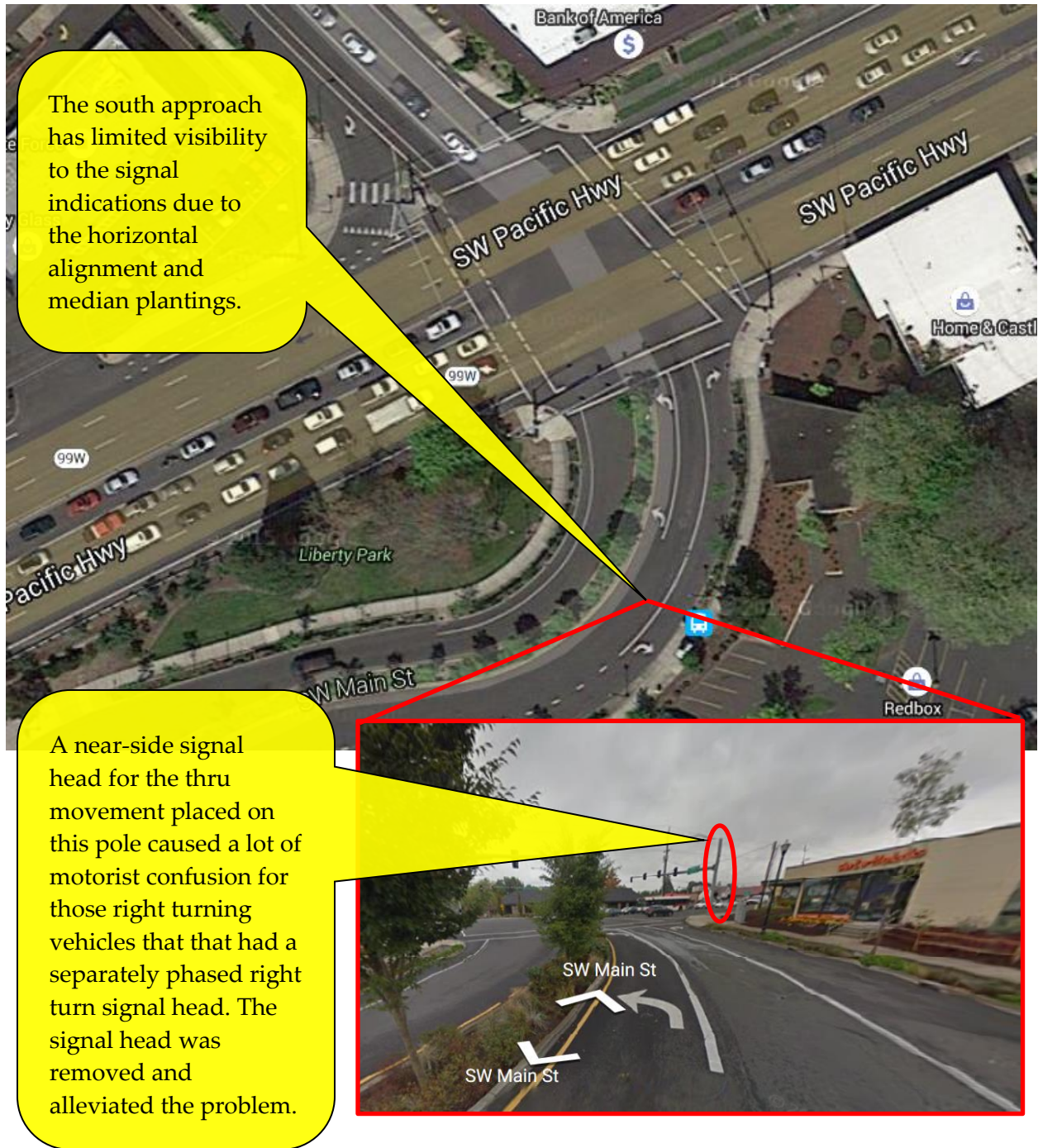
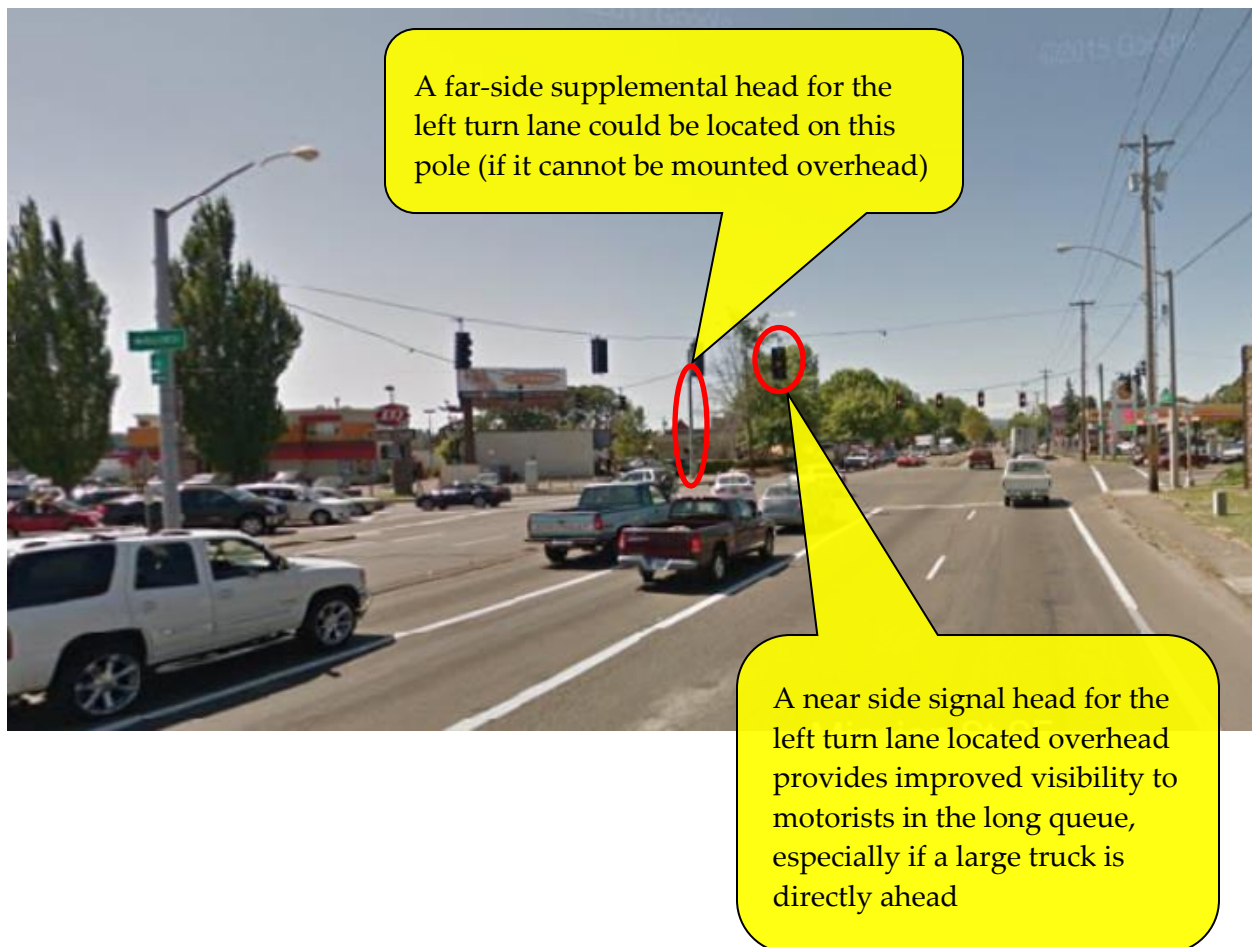


Figure 5-47 | Supplemental near-side signal head placement: Example 2



Supplemental signal heads can help improve the operation and reduce the likelihood of red light running for minor phases under certain conditions. For example, a left turn phase that has a high volume (the phase typically maxes out rather than gaps out and has long queues) with a high volume of large trucks (cars behind the large truck have an obstructed view of the signal indications the closer you get to the intersection) can benefit from a supplemental left turn signal head located overhead (preferred) or on the far-side pole to the left of the left turn phase. See Figure 5-48.

Figure 5-48 | Supplemental near-side signal head placement: Example 3



Supplemental signal heads can be beneficial for locations with known sun glare issues where the east/west facing signal heads are in direct alignment with the sunrise or sunset during certain times of the year. Sun glare can make it difficult to maintain continuous visual contact with the signal indication while approaching the intersection (temporary blindness) or difficult to determine what signal indications are on or off. While current signal indication standards have helped solve the issue of sun reflection falsely “lighting up” indications that are not actually on (clear lens with only the LEDs providing the color vs. older versions indications where red/yellow/green colored lens were used with white incandescent bulbs), maintaining continuous visual contact remains an issue. A supplemental signal head may be able to provide a better position or angle that helps direct the driver’s eye away from the sun. See Figure 5-49.

Figure 5-49 | Supplemental Signal Head Placement – Sun Glare Example



## 5.2.4 Head Mounting

There are two approved ways to mount signal heads:

- Vehicle signal bracket for attachment to a mast arm or mast arm pole
- Spanwire hanger for attachment to a span wire (note: span wire only applicable to temporary signals)

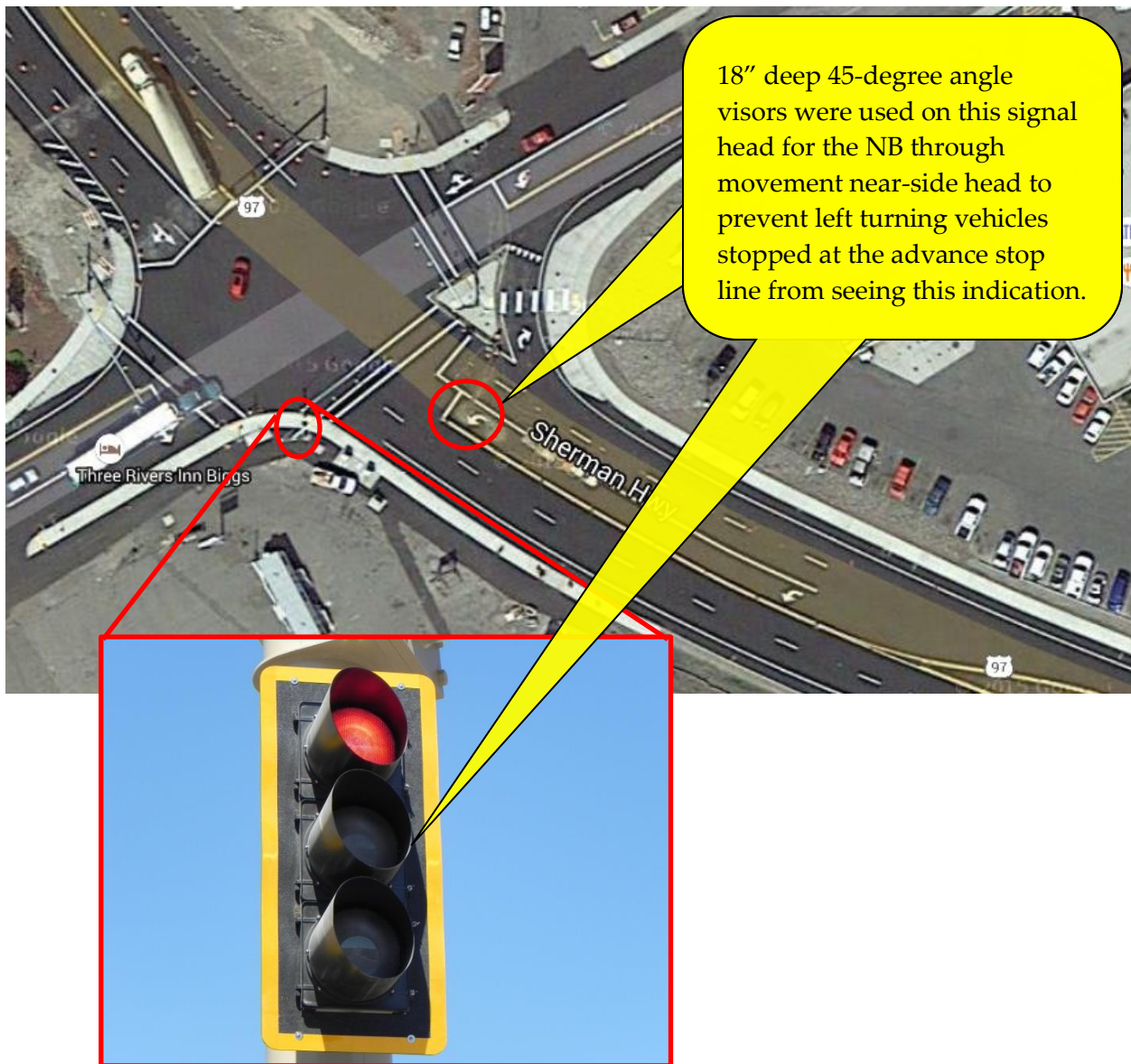
In the past, the use of plumbizers (and elevated plumbizers) to attach signal heads to mast arms was the standard, common practice. This practice required very precise control of vertical constraints, as plumbizers didn’t allow much flexibility for installation. Vehicle signal brackets, on the other hand, offer much more flexibility of the control of the vertical elevation.

## 5.2.5 Signal Head Louvers and Angle Visors

In situations where it is possible to view multiple conflicting phases of traffic signal indications which may lead to motorist confusion, signal louvers and/or 18" deep 45-degree angle visors should be used. See Figure 5-50.

Programmed signal heads were used in the past but are no longer an option.

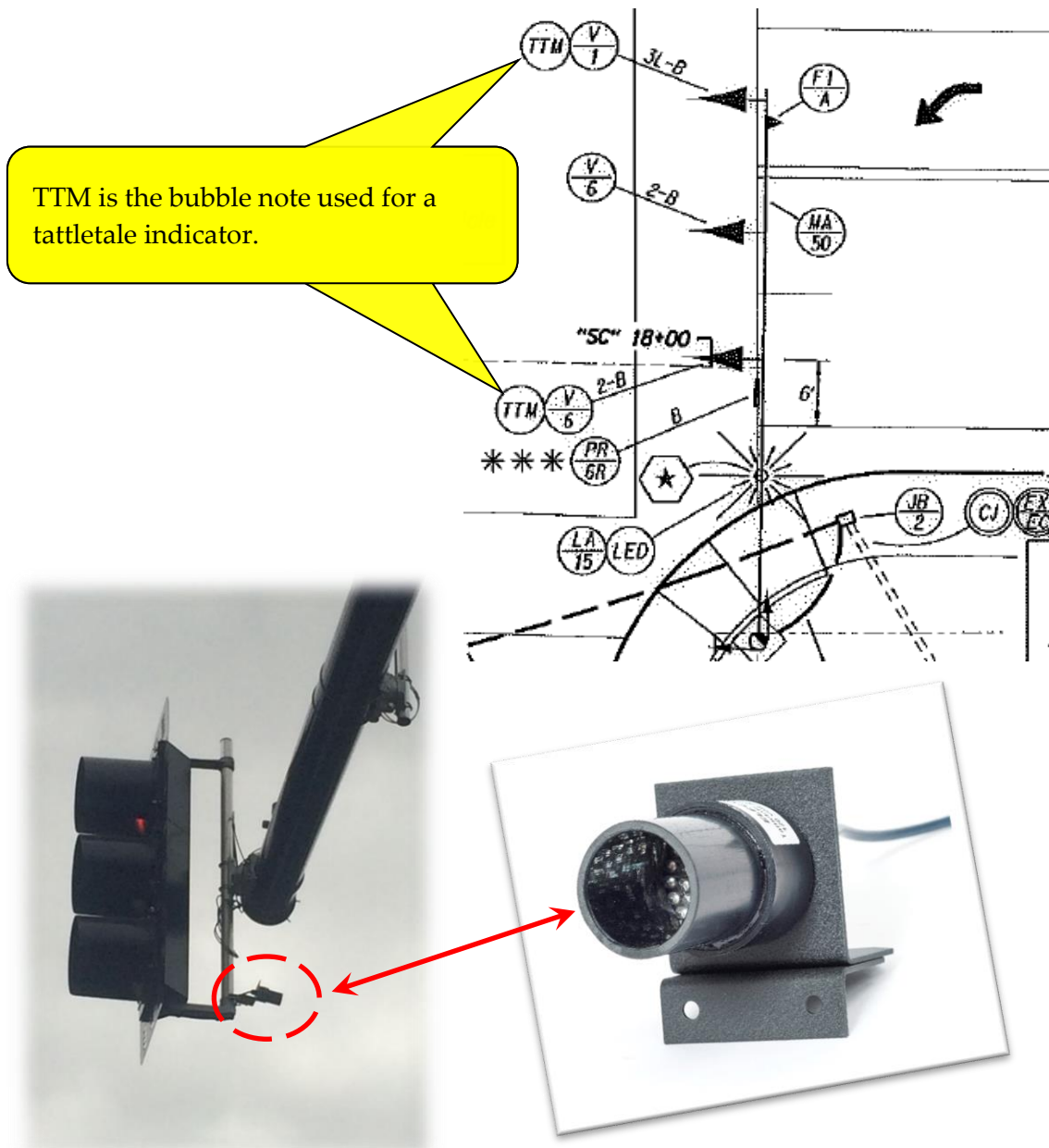
Figure 5-50 | Cut-Off Visor Example



### 5.2.6 Tattletale Indicators

Tattletale indicators are used at the request of law enforcement to aid in enforcing red light running violations by clearly indicating a red indication is active from certain viewing angles. The tattletale light is directly hardwired to the red indication. Work with region traffic to determine if there is a need for tattletale indicators. Use standard detail DET4400 and coordinate with the law enforcement to determine the best placement for the tattletale, as it is a directional device. See Figure 5-51 for an example.

Figure 5-51 | Tattletale Indicator Example



## 5.3 Sign Requirements and Layout

Depending on the operation of the intersection and type of signal heads used, certain signs may be required. Other signs may be recommended or optional. The following figures show common signs associated with traffic signal control. Note that positive message signs (e.g., “THROUGH ONLY” sign, which tells the motorist what to do) are preferred over negative message signs (e.g., “NO RIGHT TURN” sign, which tells the motorist what NOT to do).

All the signs listed in Figure 5-52 and Figure 5-53 are typically shown and detailed on the signal plan sheet, NOT on the signing plan sheet.

Signs are a common item that have the potential to be detailed on another discipline’s plan sheet. Always coordinate with the other discipline’s designer to ensure that the design item is only **detailed** in one plan sheet, not both. See chapter 21 for more information on “shown and detailed” vs. “shown and referenced” work and how to properly draft it on plan sheets.

Figure 5-52 | Common Signs Used for Traffic Control























































SIGN NUMBERS & SIZE (signs beginning with an "O" are Oregon specific)	SIGN TYPES		RECOMMENDED OR REQUIRED
	Aluminum	Part Time Restriction	
R6-2L 30"x36" 			Required for one-way streets. One way signs can be installed on the mast arm (R6-2L) OR ground mounted (R6-1L). See MUTCD 2B.40(P10)
R6-2R 30"x36" 			Required for one-way streets. One way signs can be installed on the mast arm (R6-2R) OR ground mounted (R6-1R). See MUTCD 2B.40(P10)
R10-11A 30"x36" 			Region Traffic Engineer Operational Approval Required
OR3-12 30"x36" 			State Traffic-Roadway Engineer Operational Approval Required
R5-2 30"x30" 			State Traffic-Roadway Engineer Operational Approval Required (typically used in conjunction with U-turn permitted sign)
OR3-5TD 30"x36" 			
R3-6L 30"x36" 			
R3-6R 30"x36" 			
OR3-5TT 30"x36" 			
R3-5L 30"x36"  ONLY			Required for a trap lane (where a through lane becomes a mandatory turn lane at the intersection) if the trap lane does not have a signal head with arrow indications
R3-5R 30"x36"  ONLY			Required for a trap lane (where a through lane becomes a mandatory turn lane at the intersection) if the trap lane does not have a signal head with arrow indications
R3-5A 30"x36"  ONLY			
R3-3 36"x36" 			Use of appropriate lane use signs is preferred over R3-3



Figure 5-53 | Common Signs Used for Traffic Control (Cont.)

SIGN NUMBERS & SIZE (signs beginning with an "O" are oregon specific)	SIGN TYPES		RECOMMENDED OR REQUIRED
	Aluminum	Part Time Restriction	
R3-2 36"x36" 			Use of appropriate lane use signs is preferred over R3-2. PTR version used for RxR applications
R3-1 36"x36" 			Use of appropriate lane use signs is preferred over R3-1. PTR version used for RxR applications
R5-1 36"x36" 			
R10-28 24"x30" 			For overhead mounting
OR20-1 24"x12" 			
R10-6 24"x36" 			
R10-12 30"x36" 			Required with a Type 4L signal head. Recommended when a permissive left turn phase has an exclusive left turn lane. Optional otherwise.
OR10-15 30"x36" 			Required with a Type 5 signal head
W3-8 36"x36" 			
OR20-5 24"x30" 			
W3-4 36"x36" 			
W16-13p 24"x18" 			
OR3-7a 30"x9" 			

### **5.3.1 Layout of Regulatory Signs**

Regulatory signs installed on overhead (on a mast arm) should either be located near the signal head that they apply to or centered within the lane that they apply to. For example, the “TURNING VEHICLES YIELD TO PEDS” sign should be placed near the right turn signal head and the “LEFT TURN YIELD ON green ball” sign should be centered within the left turn lane. When placing signs next to signal heads, they will need to be a minimum of 3 feet apart (measured for the center of the signal head to the center of the sign). This accommodates placement of a standard regulatory sign next to all signal indications except for a type 4L (doghouse) head. If placing a sign next to a type 4L head, the sign needs to be a minimum of 4 feet apart.

In the situation where the signal head and the sign should both be centered over the lane (e.g., three through lanes each with a “THROUGH ONLY” sign), the location of the signal head takes precedence (center over lane), and the sign should be located just to the left or right of the signal head. The message on sign will help determine which side of the signal head to place it on. For example, in the left-most through only lane, the “THROUGH ONLY” sign would be more beneficial if placed to the left of the signal head where it is more in the motorist’s line of sight if they attempt to make an incorrect left turn. In the right-most through only lane, the “THROUGH ONLY” sign would be more beneficial if placed to the right of signal head for the same reason. In the center through only lane, the placement of the sign to the left or right of signal head would both be equally beneficial.

Occasionally, there are times when two regulatory signs may be desired for one lane. For example, an exclusive right turn lane with a type 5 signal head; The “RIGHT TURN YIELD TO PEDS ON green ball” sign is required and the “RIGHT TURN ONLY” sign may also be appropriate to install. In this case, it is recommended to install one sign to the left of the signal head and one sign to the right of the signal head.

Some signs are applicable to all lanes of traffic, such as the “ONE WAY” signs. In this case, the sign should be placed in the location where the information would be the most critical. For example, on a three-lane approach where a “ONE WAY left arrow” sign is required, the location where this information is most critical is the right-most travel lane (of the three approach lanes, a motorist in the right-most lane is most likely to make wrong-way movement).

For large and/or complex intersections, locating the appropriate signing can sometimes be challenging and ideal spacing and location of signs and signal heads may not always be achievable. In these cases, aligning all necessary equipment becomes a bit of an art, but the final product should broadcast clear, unmistakable information to the approaching motorist.

## **5.3.2 Street Name Signs and Guide Signs (Custom Designed Signs)**

Street name signs and guide signs are custom designed signs (vs. standard MUTCD regulatory signs). Custom designed signs that are mounted to signal poles, mast arms or temporary span wires are detailed on a separate sign plan sheet and only referenced on the signal plan sheet. Custom signs are NOT part of the lump sum traffic signal bid item; they are paid for under the signing bid items (type of sign by the square foot and sign mount type). See chapter 21 for more information on “shown and detailed” vs. “shown and referenced” work and how to properly draft it on plan sheets.

Street name signs are required at each intersection, for each approach leg. The standard location for the street name sign is on the mast arm. If possible, the street name sign should be the sign located closest to the signal pole. All other appurtenances on the mast arm should be located to the left of the street name sign.

Standard signal pole design, as per standard drawing TM650, allows a maximum street name sign area of 21 square feet (mounted on the mast arm) and a maximum guide sign of 60 square feet (mounted on the signal pole). Always verify the size of custom signs to ensure they do not exceed the maximum dimensions. If a sign does exceed the maximum dimensions there are a couple of solutions, listed in order of preference:

1. Contact the sign designer and request a re-design of the sign to fall within maximum dimensions.
2. Ground mount the sign near the signal pole.
3. Contact the traffic structures engineer and request an analysis/recommendation for the oversized sign. A non-standard signal pole (SMX) will likely be required.

## **5.3.3 Part Time Restriction Signs (PTR)**

Part time restriction (PTR) signs are sometimes used depending on the desired operation (see the operational approval). PTR signs are electronic signs that appear black (blank-out) when not in use and display text/symbols when in use. The most common applications for use of a PTR sign includes signals with railroad/light rail preemption. Other unique applications include restricting turning movements by time-of-day/day-of-week or during certain portions of the signal phasing.

## **5.3.4 Materials and Mounting**

The standard material for small signs mounted on signal structures (poles, mast arms, temporary span wires, pedestals) is sheet aluminum. Extruded aluminum is used for larger signs. In the past, interior illuminated signs were used on signal installations due to the poor performance of sign sheeting when signs were mounted overhead. However, with the vast improvement of modern sign sheetings, coupled with the effort to be more energy efficient, interior illumination is no longer necessary or desirable. Modern sign sheetings are extremely effective and visible when mounted overhead and do not have the extra maintenance and power costs that are associated with interior illuminated signs.

There are two approved ways to mount signs that are part of the traffic signal lump sum bid item:

- Sign bracket (Type B) for attachment to a mast arm
- Sign bracket (Type A) for attachment to a span wire using a span wire hanger (note: span wire only applicable to temporary signals)

Mounts for custom designed signs (street name signs and guide signs) which are detailed on the sign plans and paid for under the signing bid items consist of the following:

- Mast arm street name sign mounts for street name signs as per TM679
- Signal pole mounts for guide signs as per TM680

## 5.4 Pedestrian Signal Equipment Layout

Pedestrian signal equipment location is guided by the Manual on Uniform Traffic Control Devices (MUTCD), the Oregon Supplement to the MUTCD, Americans with Disabilities Act Accessibility Guidelines (ADAAG), and Public Rights of Way Accessibility Guidelines (PROWAG). It should be determined in conjunction with the curb ramp and crosswalk layout. This is an iterative process, typically requiring adjustments of each feature (e.g., curb ramp, crosswalk, and pedestrian equipment) to achieve the best possible design. This process should be coordinated with the roadway designer and be done early in the design process (DAP plans) so that right-of-way needs can be addressed in a timely manner.

If raised medians are present, additional pushbuttons and/or pedestrian signal equipment may be required depending on the configuration of the median and the crosswalk. See Section 5.1.5.

### 5.4.1 Use of Pedestrian Detection

Pedestrian detection is required for all crosswalks except when the pedestrian phase will be recalled at all times. Pedestrian recalled phases are common in central business districts.

### 5.4.2 Pushbutton Requirements

Pushbuttons shall meet the following criteria. Note: An ADA curb ramp design exception is required if unable to meet any of these requirements. Contact roadway designer for assistance.

- Horizontal reach to the pushbutton shall be 10 inches maximum (using a side reach, not a forward reach). See Figure 5-54.
  - Pedestal cannot be located behind a curb. See Figure 5-57
- Clear space to access the pushbutton shall be within the 10-inch horizontal reach and unobstructed. The clear space is 30" x 48" for a parallel approach or 36" x 48" for a head-in/back-in maneuver with a maximum design slope of 1.5% (Max. 2.0% finished slope surface). The clear space shall connect to a pedestrian access route (PAR). See Figure 5-54 and Figure 5-63 thru Figure 5-69.
  - Pedestal foundation shall be installed on a level surface (1.5% max. design slope, max. 2.0% finished slope surface). See Figure 5-61 and Figure 5-62.
- Turning space is 4.5' x 5.5' (signal equipment is a vertical obstruction). See Figure 5-72.
- Vertical reach to the pushbutton is 42" to 48" from the adjacent finish grade. See Figure 5-73 and Figure 5-74.

Pushbuttons should meet the following criteria:

- Mounted on a pedestal.
- 15 feet maximum path of travel length from the pushbutton to curb ramp edge. See Figure 5-75 and Figure 5-76.
- 8-foot minimum separation between buttons (one pushbutton per pedestal). Note this criterion doesn't apply to (see Section 5.4.6):
  - Diagonal curb ramps allowed by ADA curb ramp design exception
  - Two curb ramps that share a single turning space/level area

## **5.4.3 Deviations from Pushbutton Location Requirements**

Meeting all the criteria listed in section 5.4.2 may be impossible at certain locations and compromises in the design will need to be made. The shall criteria are the highest priorities and should be met before attempting to meet any other criteria, as not meeting these criteria requires an ADA curb ramp design exception. The should criteria, while important, are a lower priority and can usually be acceptably mitigated by the deviations discussed in sections 5.4.5, 5.4.6, and 5.4.7.

If unable to meet any of the above listed criteria in section 5.4.2, deviations may be considered. Common deviations are listed below. Any deviations require approval of the state traffic signal engineer during the design approval process.

- Pushbutton mounted on a large pole. See Section 5.4.5.
- Two pushbuttons per pedestal/pole (note: this is the preferred solution for diagonal curb ramps and two curb ramps that share a single turning space). See Section 5.4.6.
- Use of an extension bracket mount. See Section 5.4.7.
- Vertical reach to the pushbutton is less than 42". See Section 5.4.8.

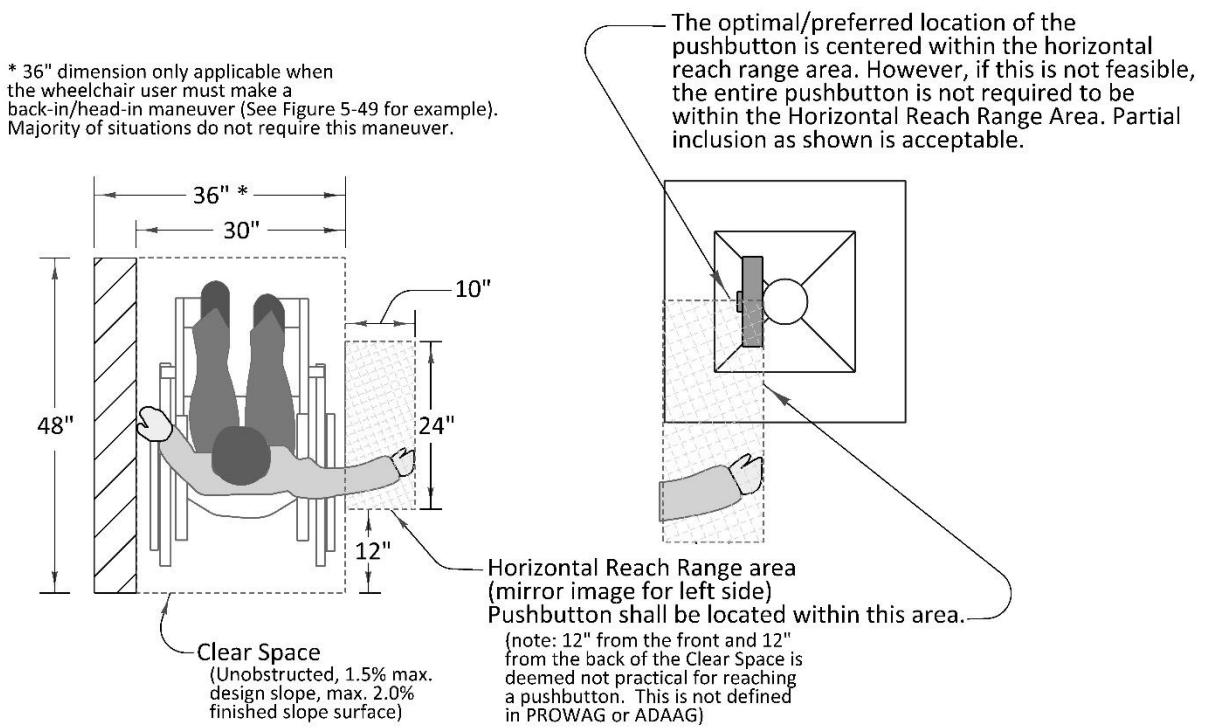
## 5.4.4 Verifying Pushbutton Requirements

Pushbuttons are mounted with the face of the pushbutton parallel to crosswalk it serves (it should be in-line with the crosswalk striping). It can be mounted on either side of the pedestal as long as all the requirements in section 5.4.2 are met.

During design, the horizontal reach and clear space requirements for the pushbutton should be verified using the design vehicle (wheelchair user) in CADD. See Figure 5-54. The design vehicle should be simulated for each pushbutton in both approach directions. **The results of each simulation shall accompany the plan sheets when submitted to the state traffic signal engineer for design approval.**

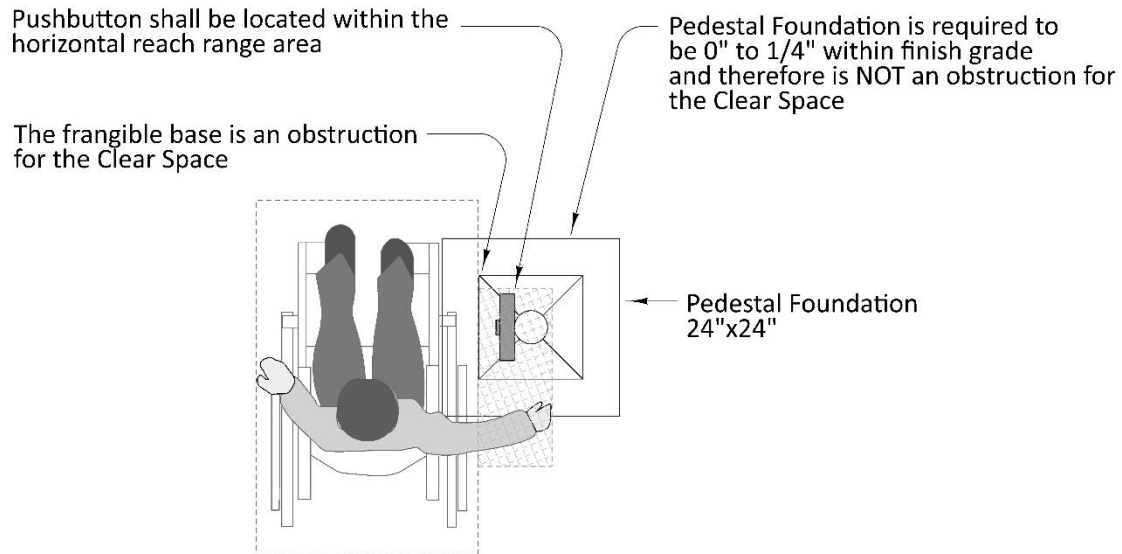
An obstruction to the clear space is defined as any vertical difference that is greater than ¼" or any slope that is designed at greater than 1.5% (maximum 2.0% finished slope surface). When running simulations at each pushbutton, the clear space shall be unobstructed. At intersections with sidewalk and curb ramps, the clear space shall not extend into the vehicular travel way or roadway shoulder. At intersections without sidewalk (rural signals with a pedestrian pad or level landing area on the shoulder), the clear space and connected pedestrian access route shall be free of vehicle encroachment. See section 5.1.8, Figure 5-21, Figure 5-22 for more information on verifying the vehicle swept path.

Figure 5-54 | Design Vehicle (Clear Space with 10" Max Horizontal Reach)



The horizontal reach is measured from the obstruction to the pushbutton. For a pedestal, the obstruction is the edge of the frangible base. The foundation edge is not considered an obstruction as standard drawing TM457 requires the top of foundation to be flush with finish grade (0" to 1/4" vertical tolerance). See Figure 5-55.

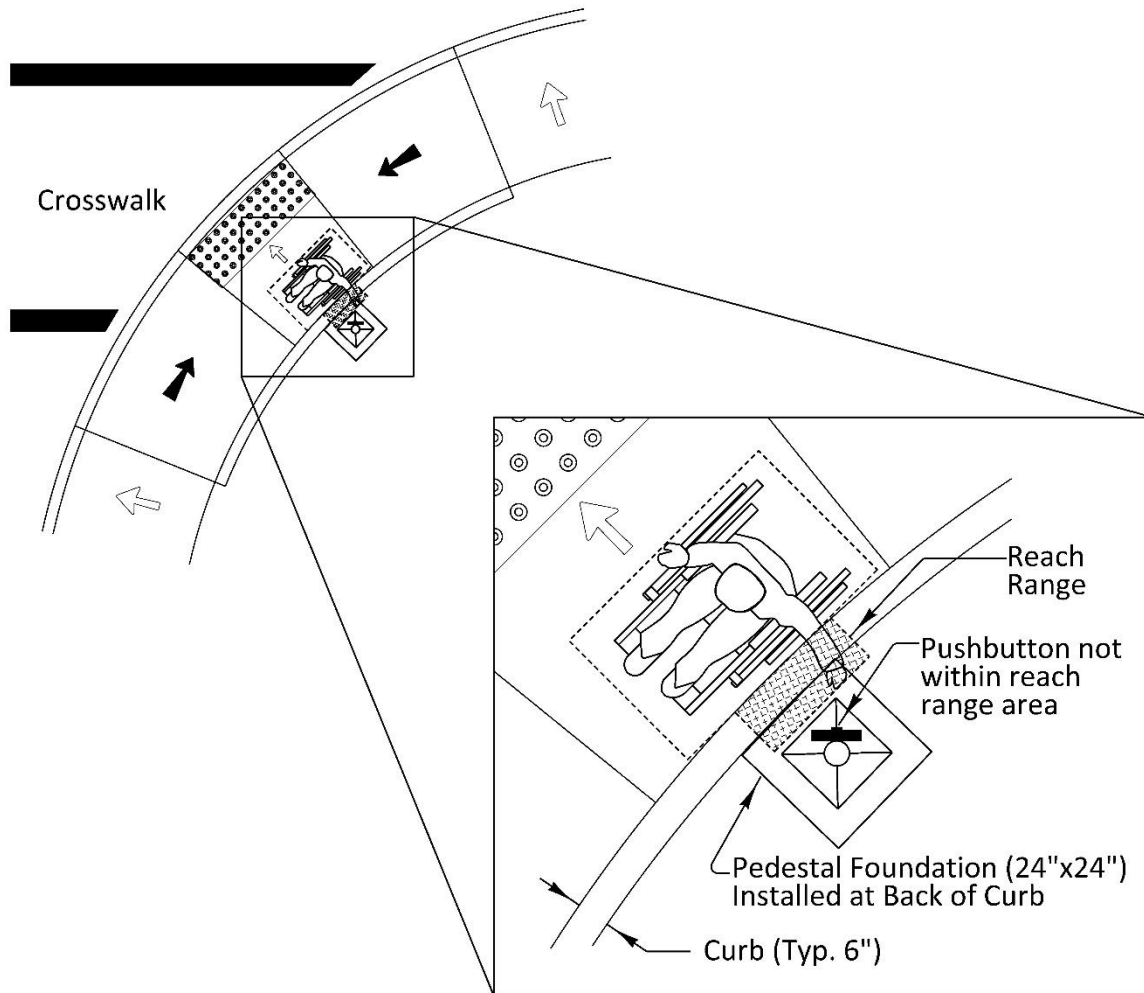
Figure 5-55 | Measuring Horizontal Reach to Pushbutton Mounted on Pedestal





The 10-inch horizontal reach eliminates the placement of the pedestal behind curbs. Curbs are typically 6 inches wide and with a standard construction of the foundation against the back-of-curb, the horizontal reach becomes approximately 13 inches. See Figure 5-56.

Figure 5-56 | Pedestals Located Behind Curbs Do NOT Meet 10 Inch Horizontal Reach Requirement

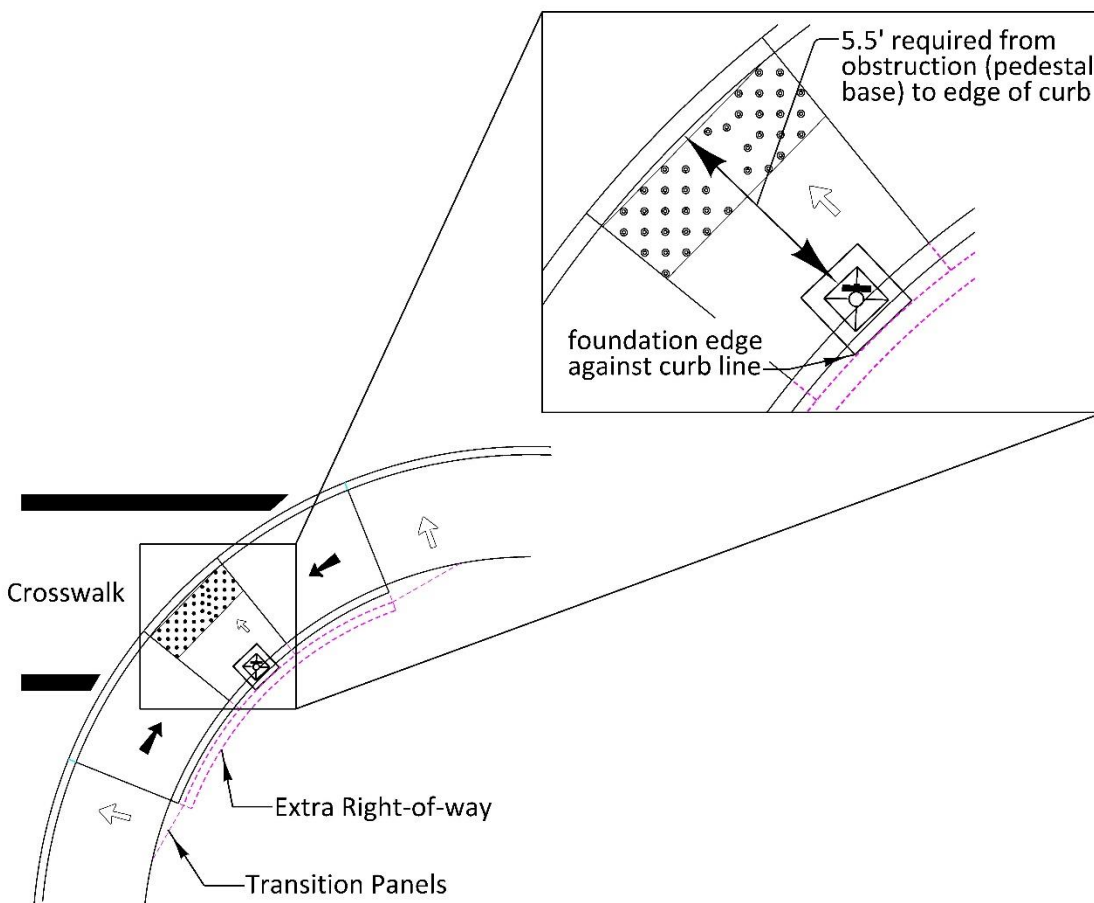


While it may be possible to integrate the pedestal foundation with the curb installation or modify the pedestal foundation to achieve the 10-inch horizontal reach, it is not recommended for two reasons:

- Pedestals located behind a curb makes finding the pushbutton more difficult for low vision pedestrians using a cane (cane sweeps typically don't go over curbs).
- The increased complexity of construction and increased risk of error (requires custom design details and excellent coordination and/or cooperation between subcontractors).

Always place the pedestal in front of the curb. This will likely require transition panels and slightly more right-of-way to achieve the required 5.5 feet between the curb at the crosswalk and the pedestal (obstruction), shown in dashed purple lines in Figure 5-57.

Figure 5-57 | Pedestals Should be Located in Front of Curbs



When placing a pedestal in front of a curb, do not wrap the curb around the pedestal foundation creating tight angles as shown in Figure 5-58. This type of design is more complicated for construction and tends to create maintenance issues (e.g., ponding and trash/debris collection). Install the curb as straight as possible and gently taper/transition to a match point as shown in Figure 5-59. This creates a slightly wider useable path and more room to maneuver a mobility device near the pushbutton. Some additional right-of-way may be required to install a gentle taper/transition for retrofits, but it is highly recommended as this provides a much better installation for the user and for maintenance. See Figure 5-57 and Figure 5-60 for additional examples.

Figure 5-58 | Pedestal with Curb Around Foundation – Avoid Tight Angles

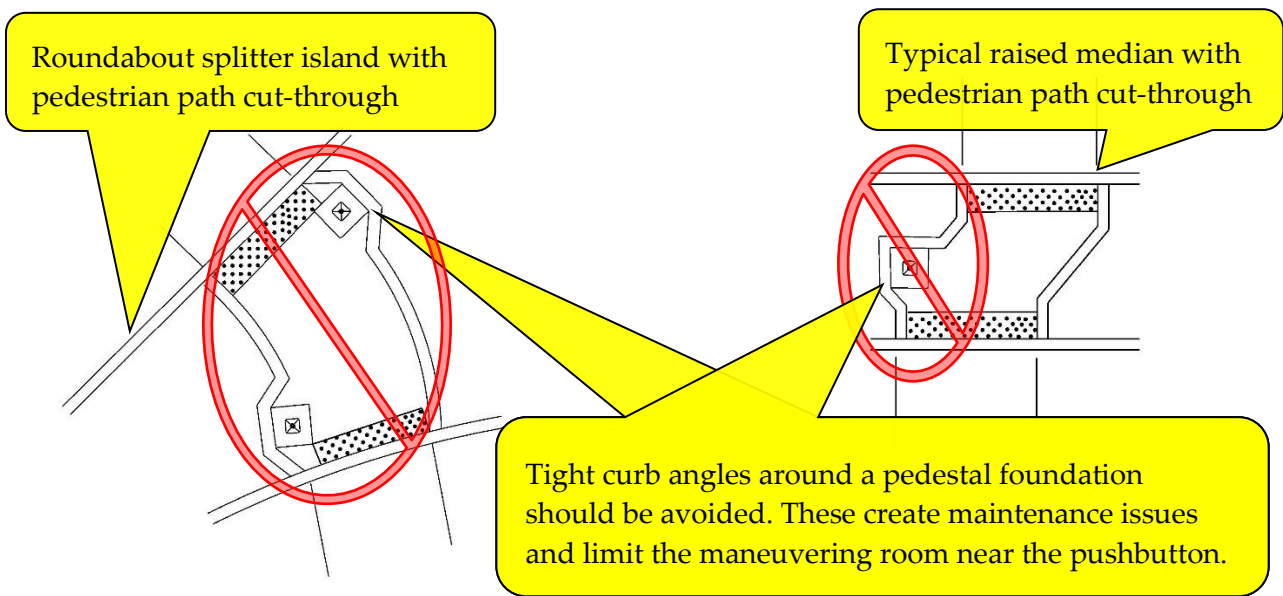


Figure 5-59 | Pedestal with Curb Around Foundation – Use Gentle Tapers

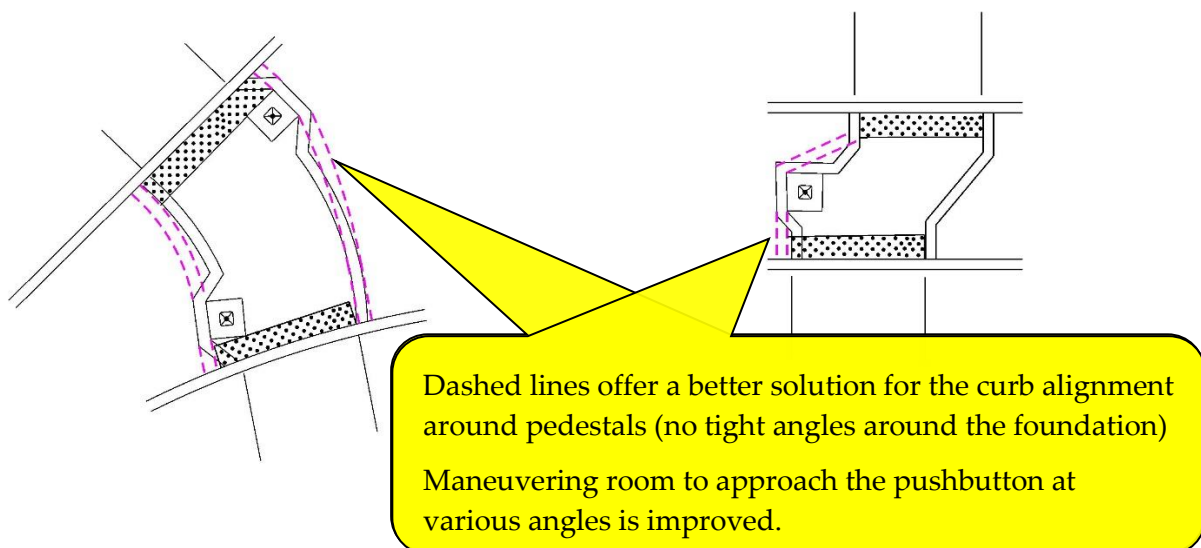
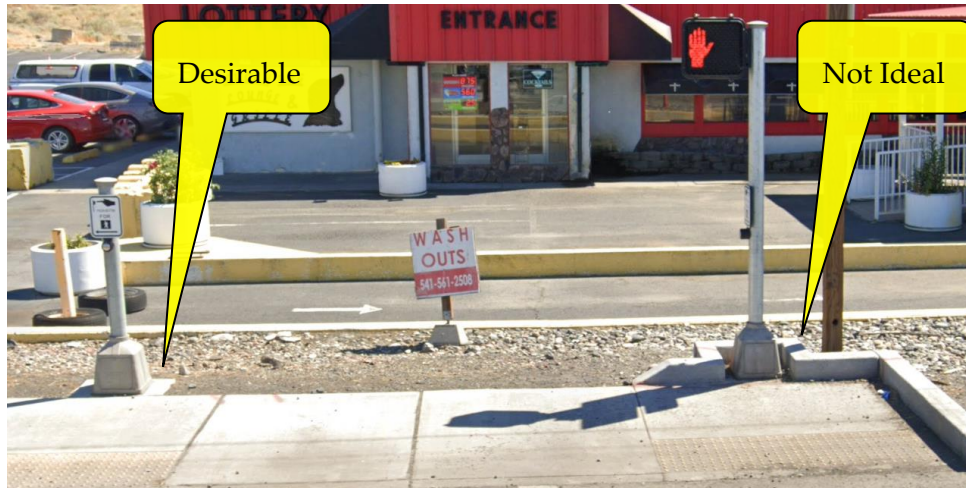
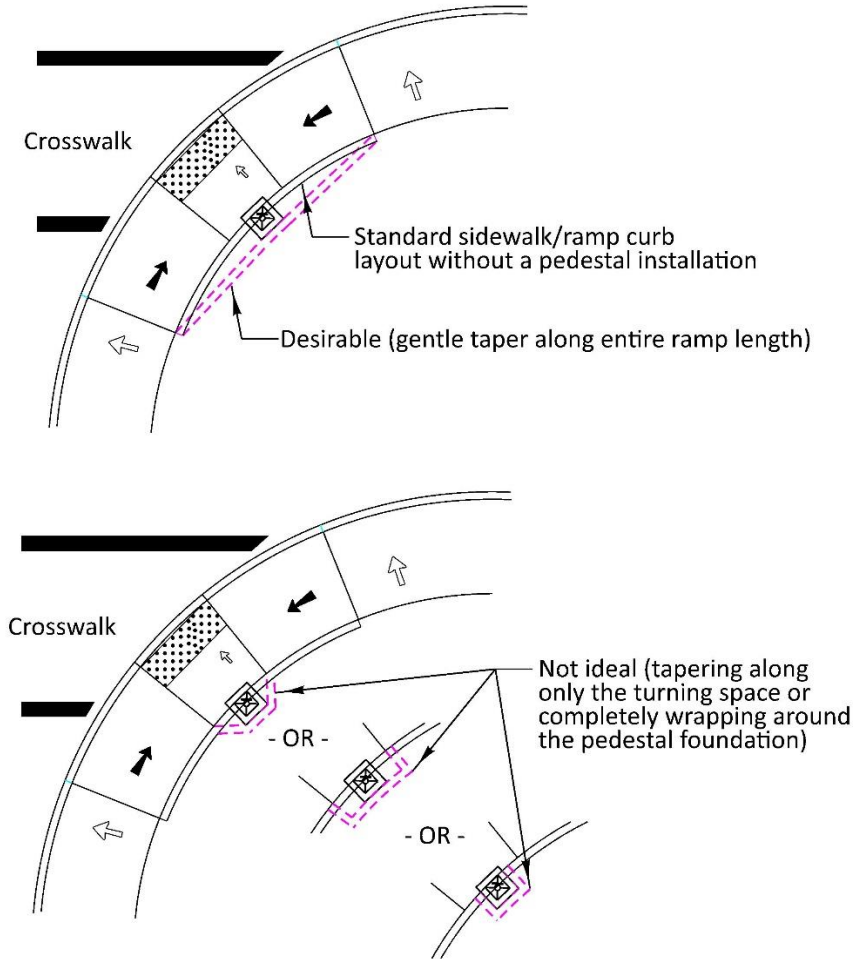


Figure 5-60 | Pedestal with Curb Around Foundation – Examples of Desirable and Not Ideal Curb Layouts



Pedestal foundations must be placed on a level surface (1.5% max. design slope) to meet the requirements for the 10-inch horizontal reach and clear space. See Figure 5-61. Do not place a pedestal foundation across more than one plane (e.g., different concrete panels with different slopes). See Figure 5-62.

Figure 5-61 | Pedestal Foundation Placement – Example 1

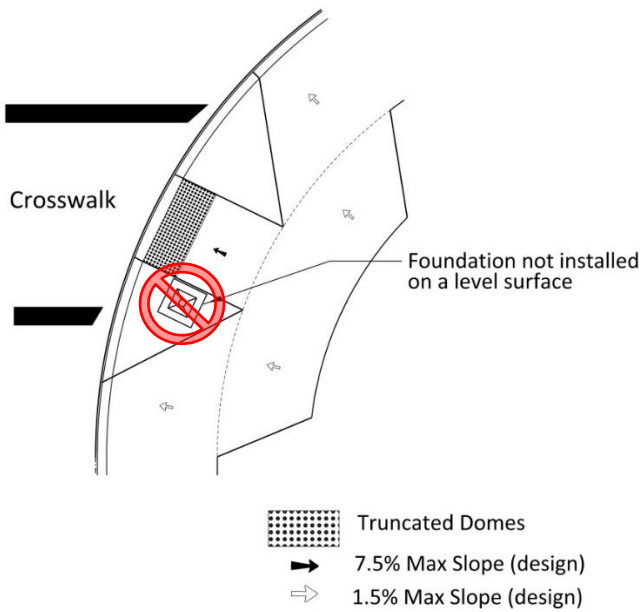
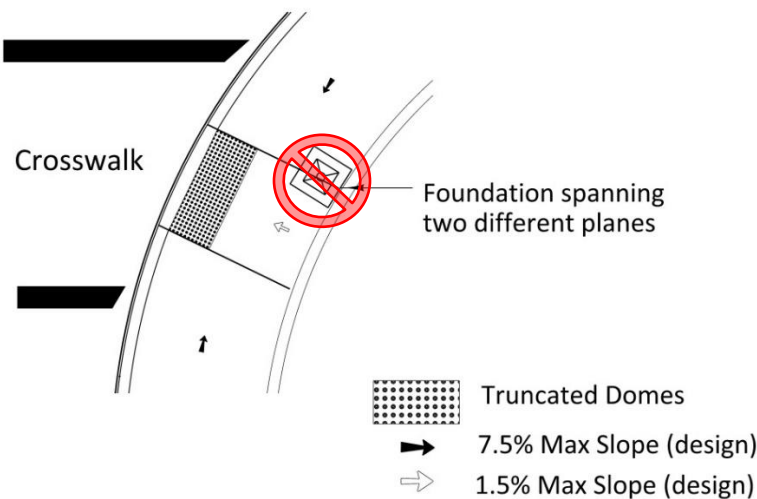


Figure 5-62 | Pedestal Foundation Placement – Example 2



The clear space is the area defined as being level (having a maximum design slope of 1.5%) and is 30" x 48" for a typical parallel approach. If the wheelchair user has to back-in/head-in to access the pushbutton, the clear space requirement becomes a little larger: 36" x 48". Typically, the only time a wheelchair user will have to back-in/head-in is when the pushbutton is located on a large pole at perpendicular style curb ramp. See Figure 5-63. Due to the additional effort required for a back-in/head-in maneuver, curb ramp design and pushbutton locations that require this maneuver should be avoided.

The curb ramp turning space (with an obstruction at back-of-walk, such as a pedestal or signal pole) is defined as the 4.5' x 5.5' unobstructed area located in front of the curb ramp, with the longer dimension towards the curb ramp. The clear space and turning space are independent of each other; they may coincide, overlap, or not touch depending on the curb ramp type and geometrics. **The ideal pushbutton location occurs when the turning space and clear space coincide or have a large overlap for the following reasons:**

- The path the wheelchair user takes to push the button and use the curb ramp is the most direct path
- The pushbutton location is more likely to meet the other ODOT and MUTCD section 4E.08 criteria (e.g. distance from crosswalk: see Figure 5-88, distance from edge of curb ramp: see Figure 5-75, etc.)
- Typically easier to meet the sidewalk and curb ramp slope requirements

Figure 5-63 | Turning and Clear Space – Back-in/Head-in Maneuver Required

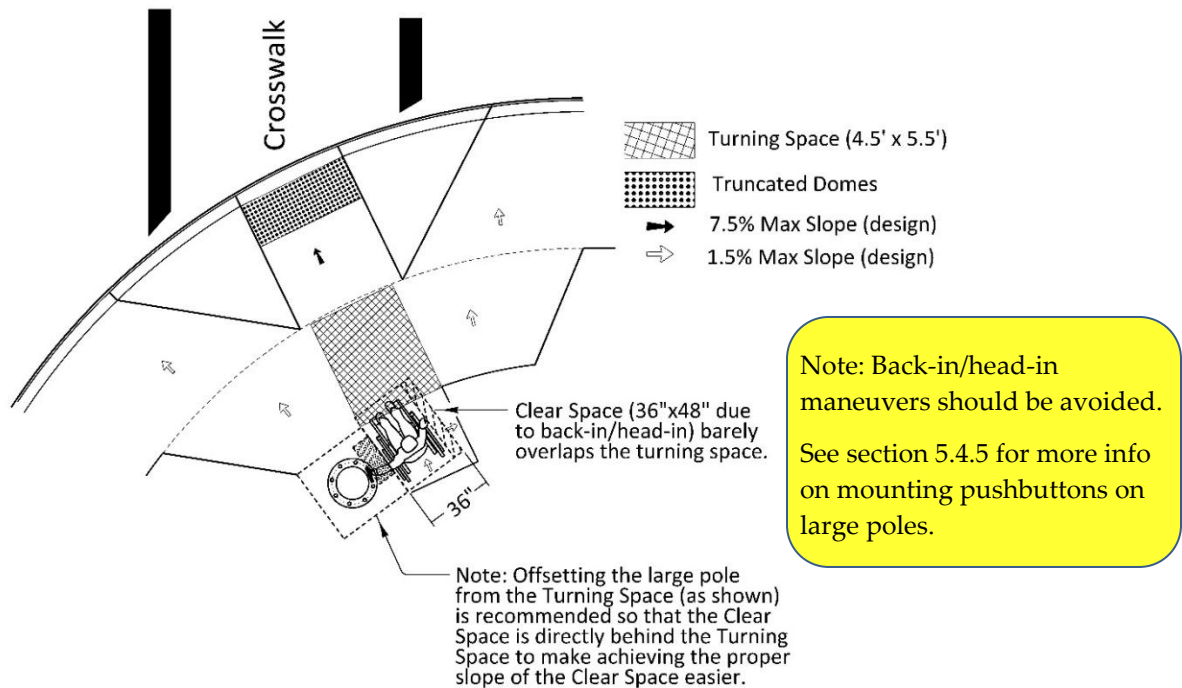


Figure 5-64 through Figure 5-66 show pushbutton placement examples for a parallel approach that meets the shall requirements for horizontal reach and clear space for the three standard types of curb ramps (perpendicular, parallel, and combo), while also showing how the clear space and turning space relate to each other.

Figure 5-64 | Turning and Clear Space – Perpendicular Curb Ramp (Parallel Approach)

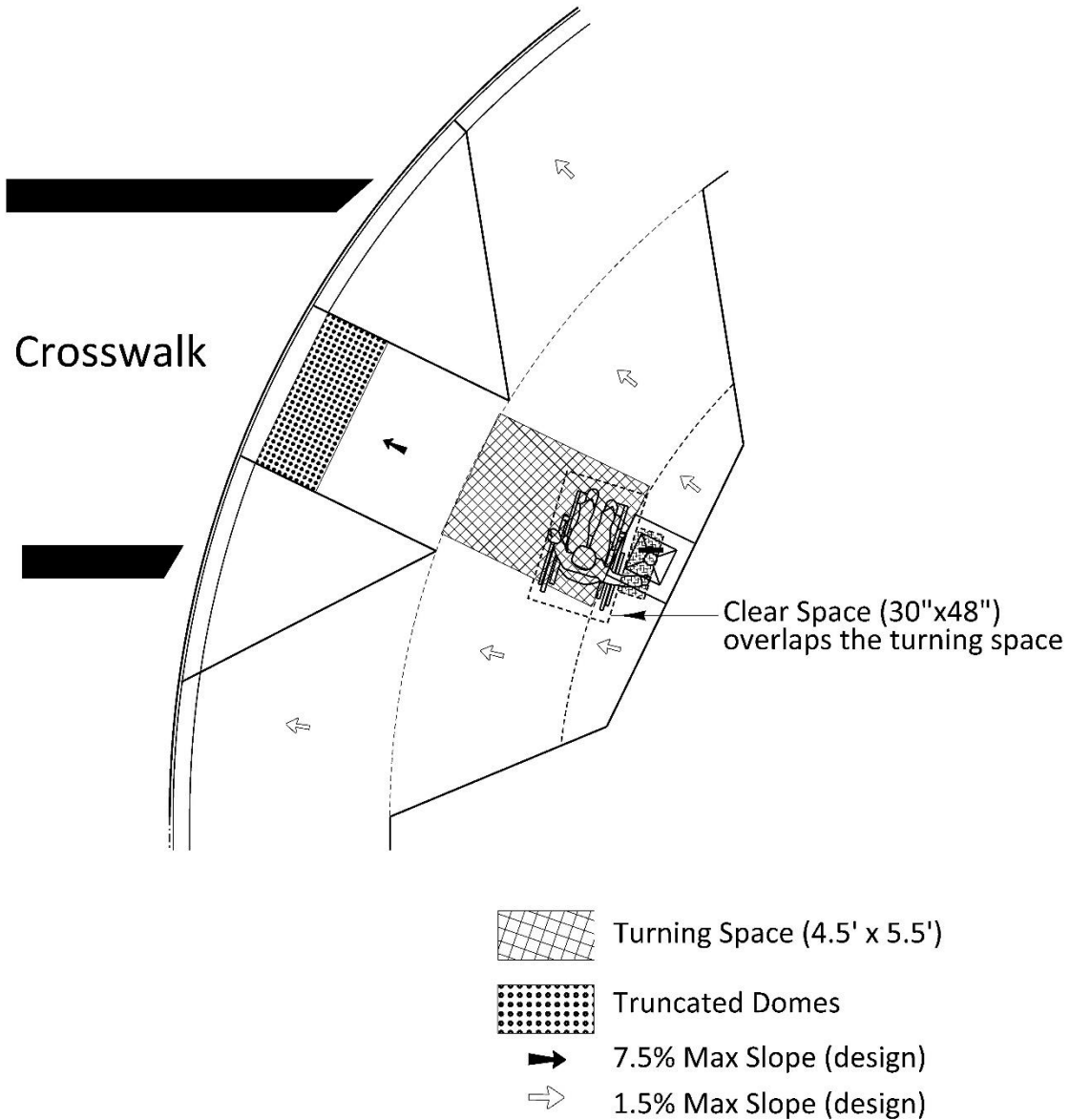
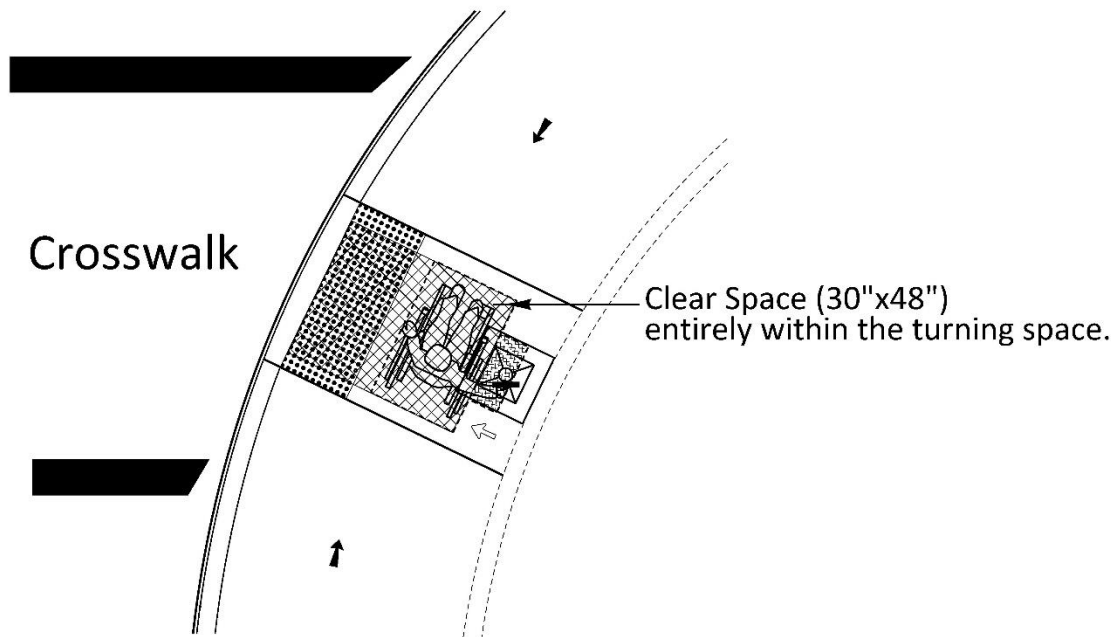


Figure 5-65 | Turning and Clear Space – Parallel Curb Ramp (Parallel Approach)



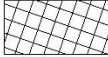

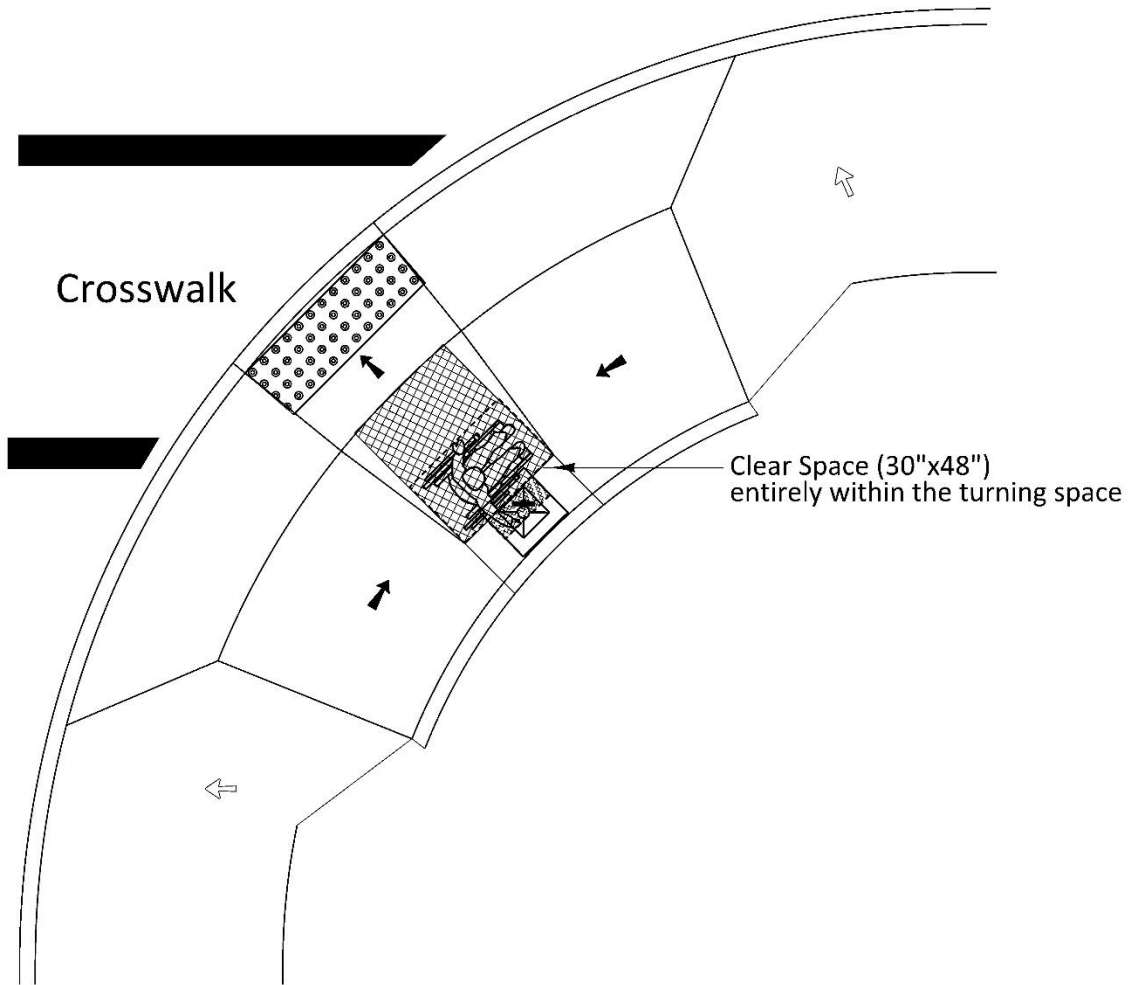
-  Turning Space (4.5' x 5.5')
-  Truncated Domes
-  7.5% Max Slope (design)
-  1.5% Max Slope (design)




Figure 5-66 | Turning and Clear Space – Combo Curb Ramp (Parallel Approach)



 Turning Space (4.5' x 5.5')

 Truncated Domes

 7.5% Max Slope (design)

 1.5% Max Slope (design)

When a wheelchair user is accessing the pushbutton, the clear space (30"x48" or 36"x48" as required) cannot be located within any surface that has a designed slope greater than 1.5% (max. 2.0% finished slope surface). See Figure 5-67 through Figure 5-69.

Figure 5-67 | Accessing the Pushbutton – Clear Space within 1.5% Slope (design), Example 1

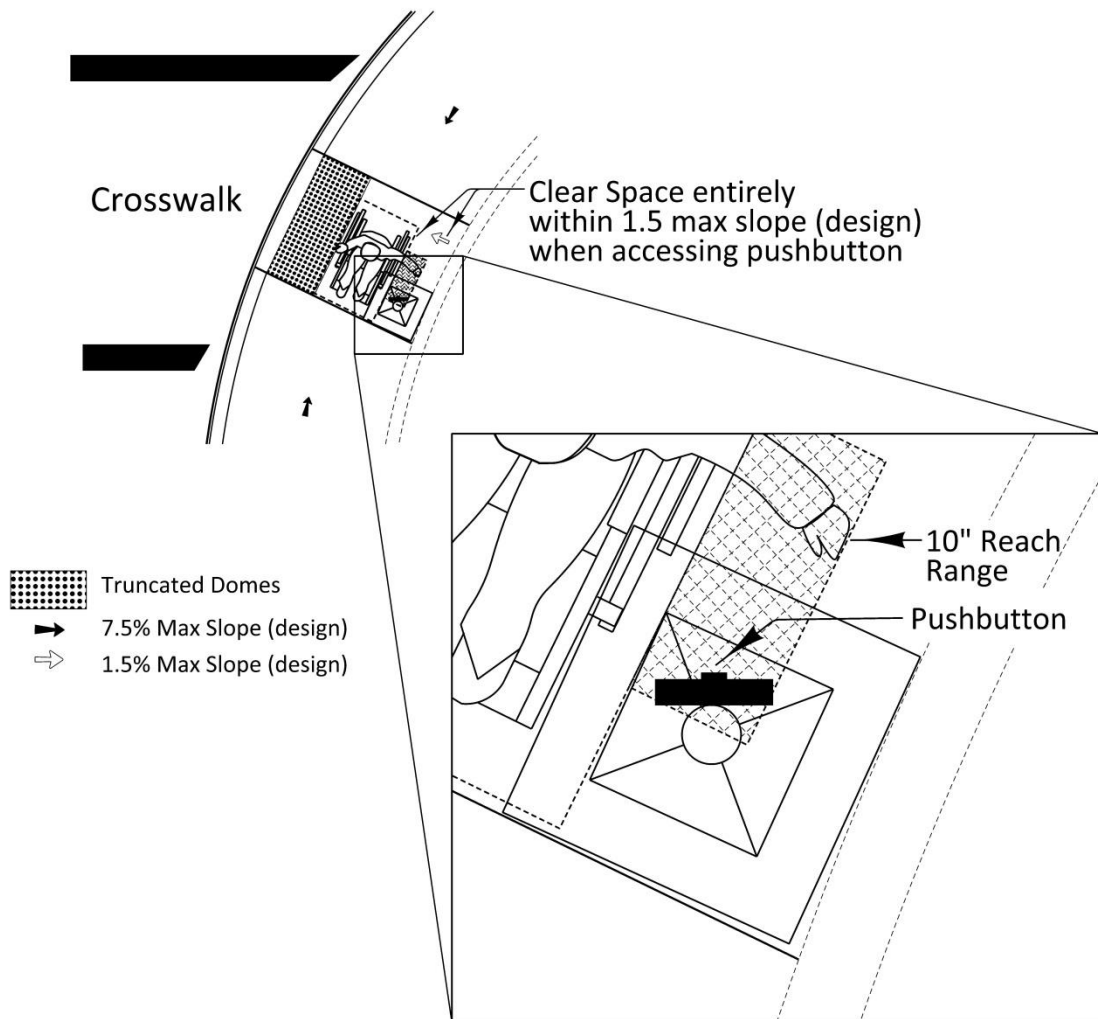


Figure 5-68 | Accessing the Pushbutton – Clear Space within 1.5% Slope (design), Example 2

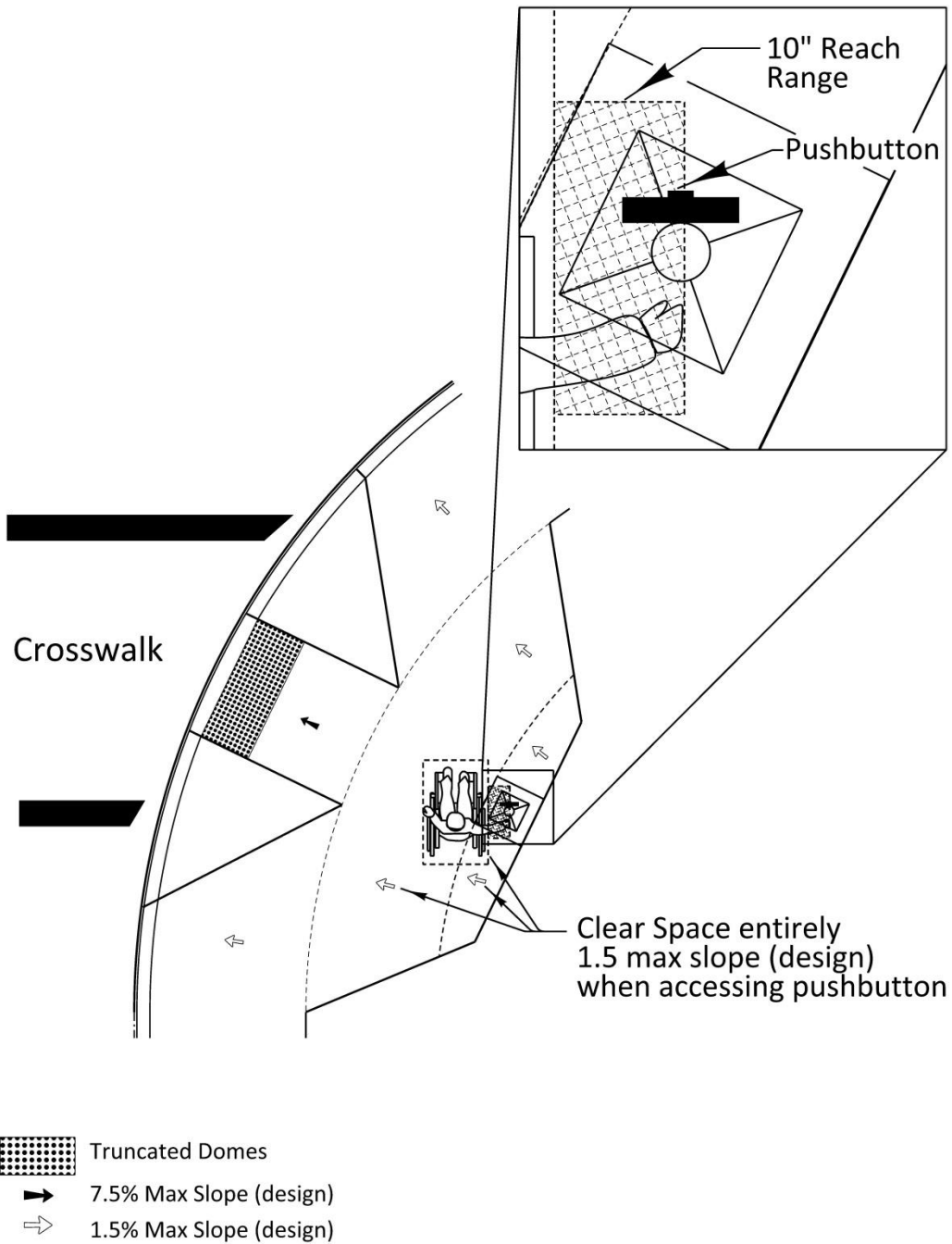
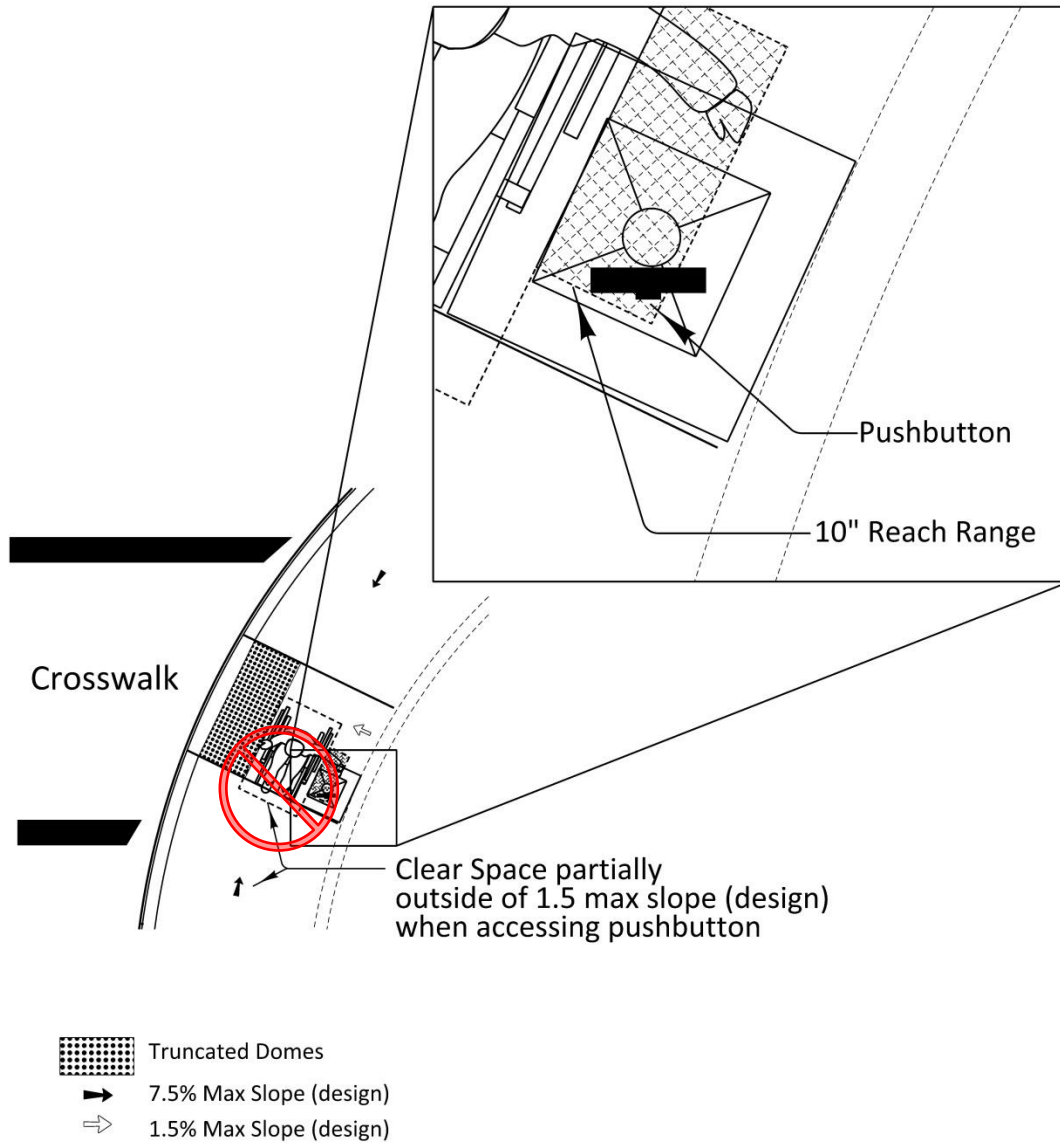


Figure 5-69 | Accessing the Pushbutton – Clear Space NOT within 1.5% Slope (design)



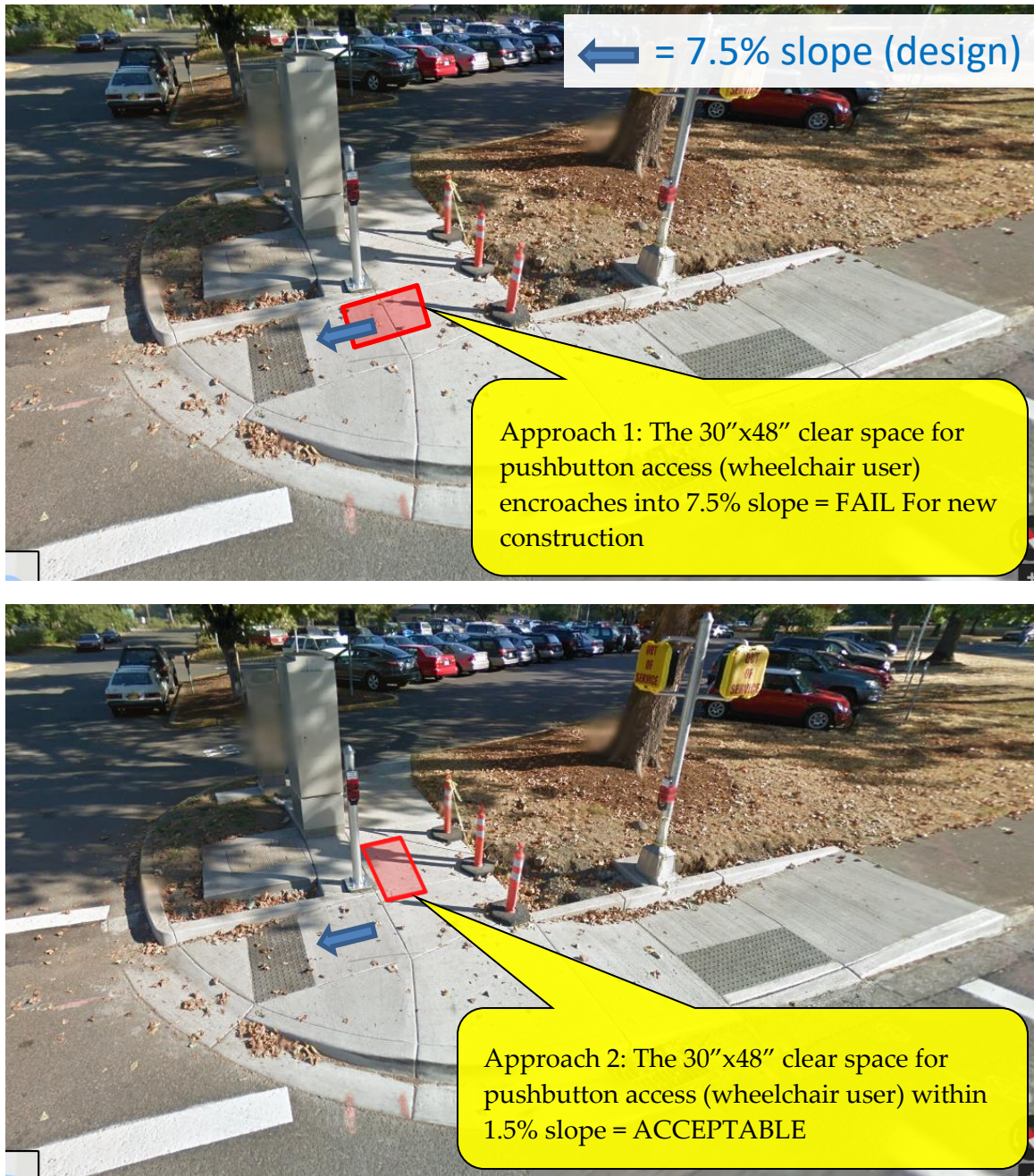
The clear space surface shall be comprised of a material that is solid (e.g., concrete, asphalt). Use of a poorly compacted material (pea gravel, uncompacted aggregate, or soil) will make it difficult or impossible for a wheelchair user to access the pushbutton. This is especially important to consider for temporary signals. See Figure 5-70.

Figure 5-70 | Poorly Compacted Material Example



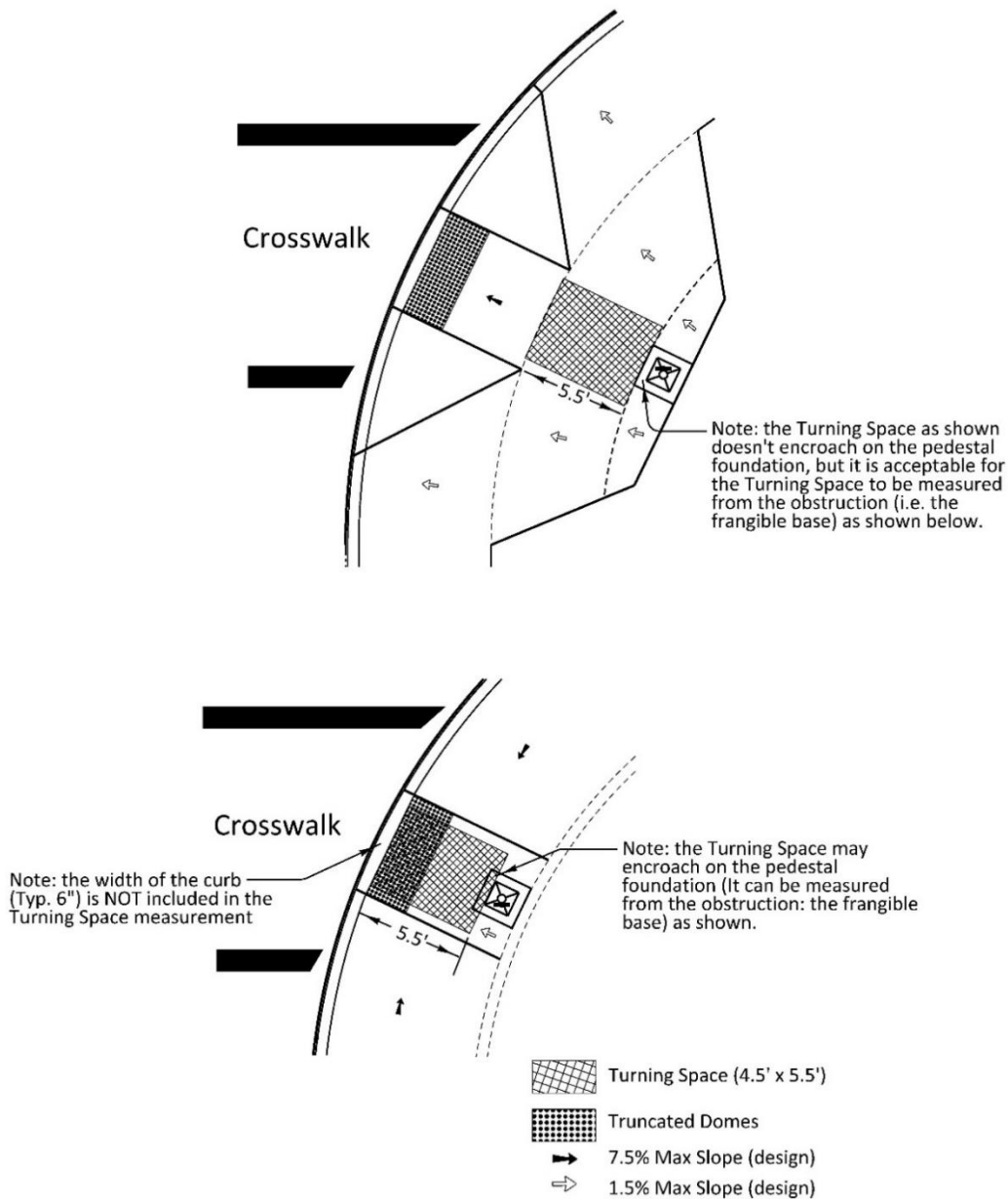
Depending on the curb ramp geometry, there may be multiple ways to parallel approach the pushbutton, which can mean the difference between meeting or failing the clear space slope requirement (1.5% design slope). See Figure 5-71. Be sure to verify the clear space from all possible approaches with the design vehicle in CADD. While only one approach is required to meet the requirements, accessing each approach to the pushbutton can lead to a better overall design that minimizes the amount of maneuvering for the wheelchair user.

Figure 5-71 | Multiple Ways to Parallel Approach the Pushbutton



The turning space for a curb ramp with pedestals or signal poles (obstructions) is required to be 4.5' x 5.5' with the 5.5' dimension measured from the obstruction towards the curb ramp. The width of the curb shall NOT be included in the measurement. An obstruction to the turning space is defined as any vertical difference that is greater than 1/4" or any slope that is designed at greater than 1.5% (Maximum 2.0% finished slope surface). See Figure 5-72.

Figure 5-72 | Turning Space Measurement for Curb Ramp with Signal Equipment



The vertical reach requirements for the pushbutton will always be met when using standard traffic signal pedestals, poles, and pushbuttons. Pushbuttons mounted to non-standard equipment, structures, or in unusual locations require verification of the vertical requirements. This includes poles with ornamental bases and poles located behind or above barriers. See examples shown in Figure 5-73 and Figure 5-74.

Figure 5-73 | Verification of Pushbutton Vertical Height Required (Non-Std. Equipment) – Example 1



Figure 5-74 | Verification of Pushbutton Vertical Height Required (Non-Std. Equipment) – Example 2





Pushbuttons should be located no more than 15 feet from the access to the crosswalk (edge of curb ramp). See Figure 5-75. This distance should be measured going through the middle of the turning space to the edge of the curb ramp, which may not always be a straight line. See Figure 5-76. To achieve the most direct measurement (straight line) the clear space and the turning space should coincide or have a large overlap.

Note that the MUTCD section 4E.08 states that the pushbutton should be 1.5 feet to 6 feet from the edge of curb ramp and allows up to 10 feet when physical constraints make closer placement impractical. While it is desirable to follow the MUTCD guidance and stay within 6 feet, we know that many curb ramps designed using ODOT standards will not even allow the placement of a pushbutton within 10 feet due to the slope requirements and the 7-inch standard curb exposure. Therefore, ODOT allows up to 15 feet to accommodate the majority of curb ramp designs.

If it is not feasible to place the pushbutton within 15 feet, adjustments to the signal timing walk phase can be made to mitigate the longer distance. Coordinate with the region signal timer if this distance will exceed 15 feet.

Figure 5-75 | Distance from Pushbutton to Crosswalk (Edge of Curb Ramp)

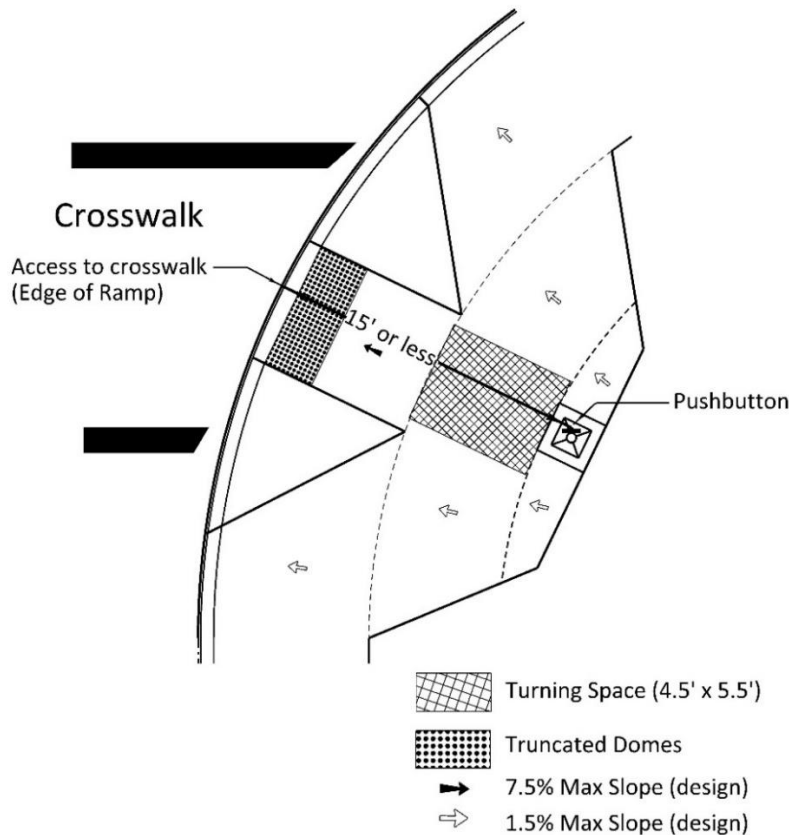
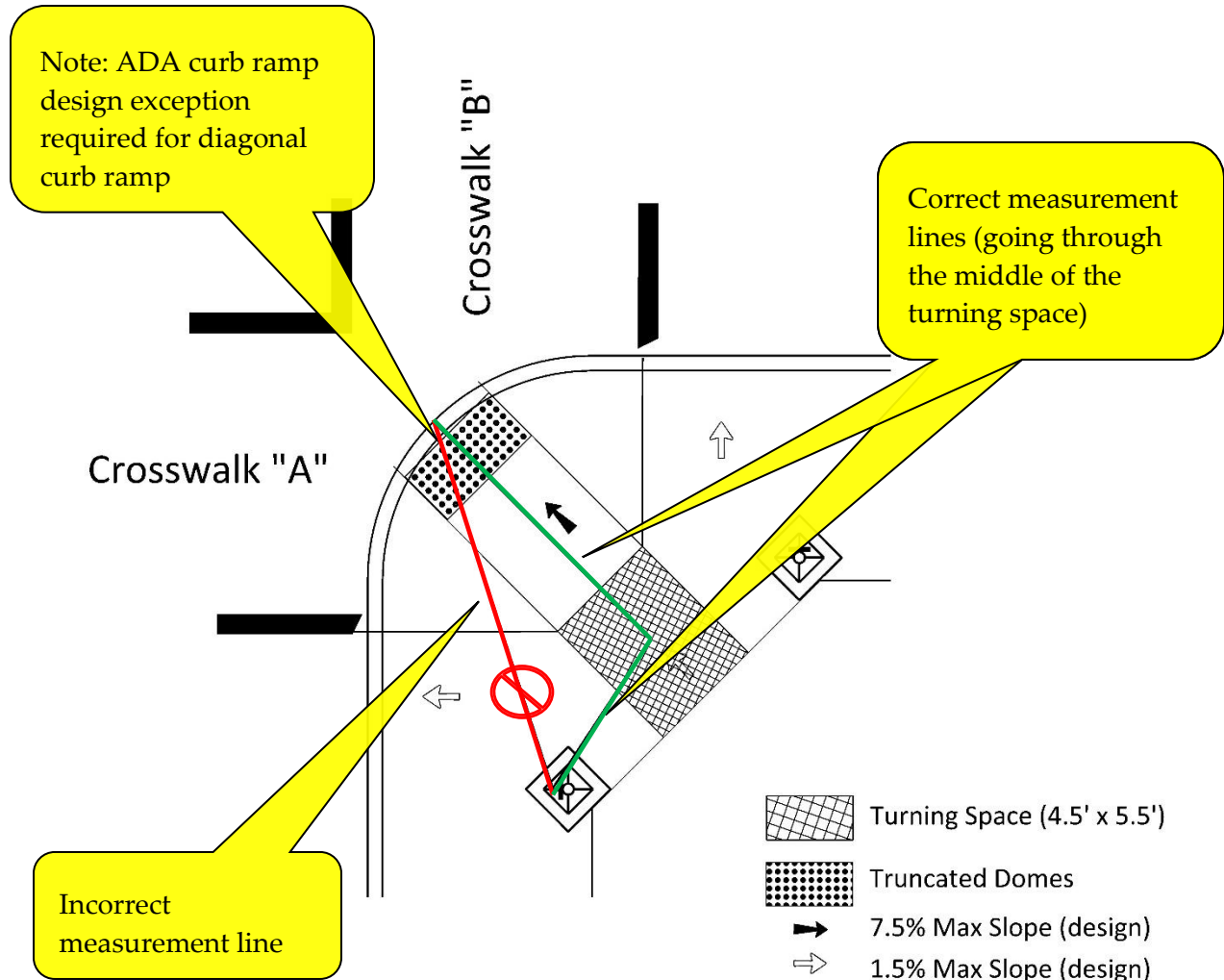


Figure 5-76 | Measuring Distance from Pushbutton to Crosswalk (Edge of Curb Ramp) Example

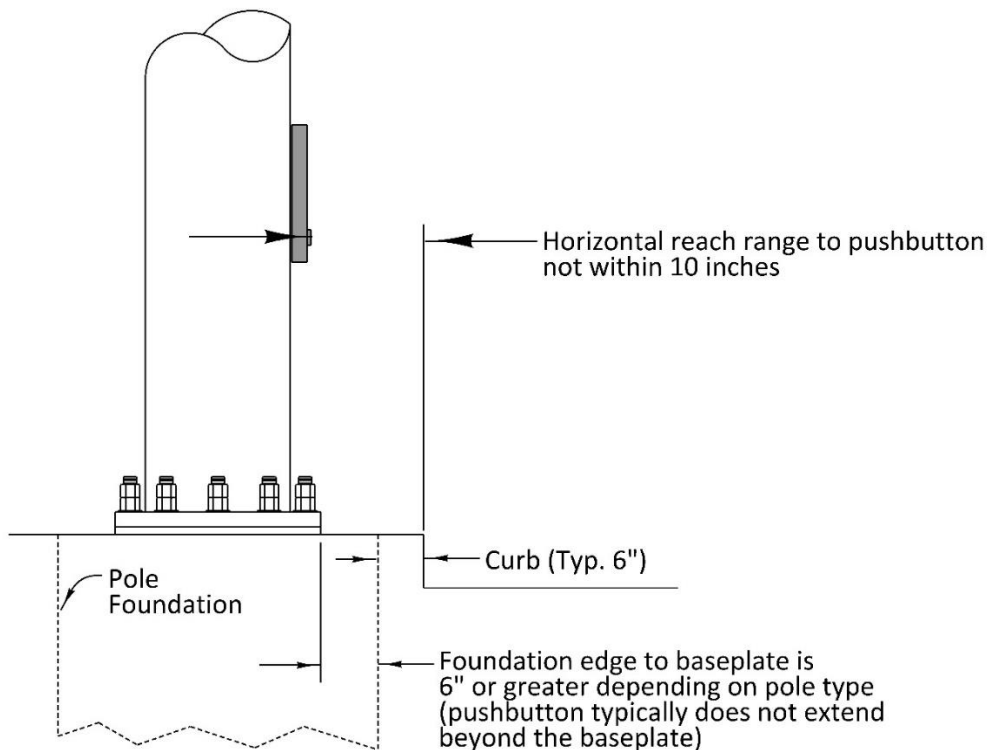


### 5.4.5 Deviation: Pushbutton Mounted on a Large Pole

Pushbuttons mounted on large poles are discouraged due to the tight tolerances for the 10-inch horizontal reach and high probability of requiring an extension bracket mount. *As such, pushbuttons mounted on a large pole should only be considered in rare cases where a pedestal cannot be installed (e.g., areas with limited right-of-way, utility conflicts, etc.).*

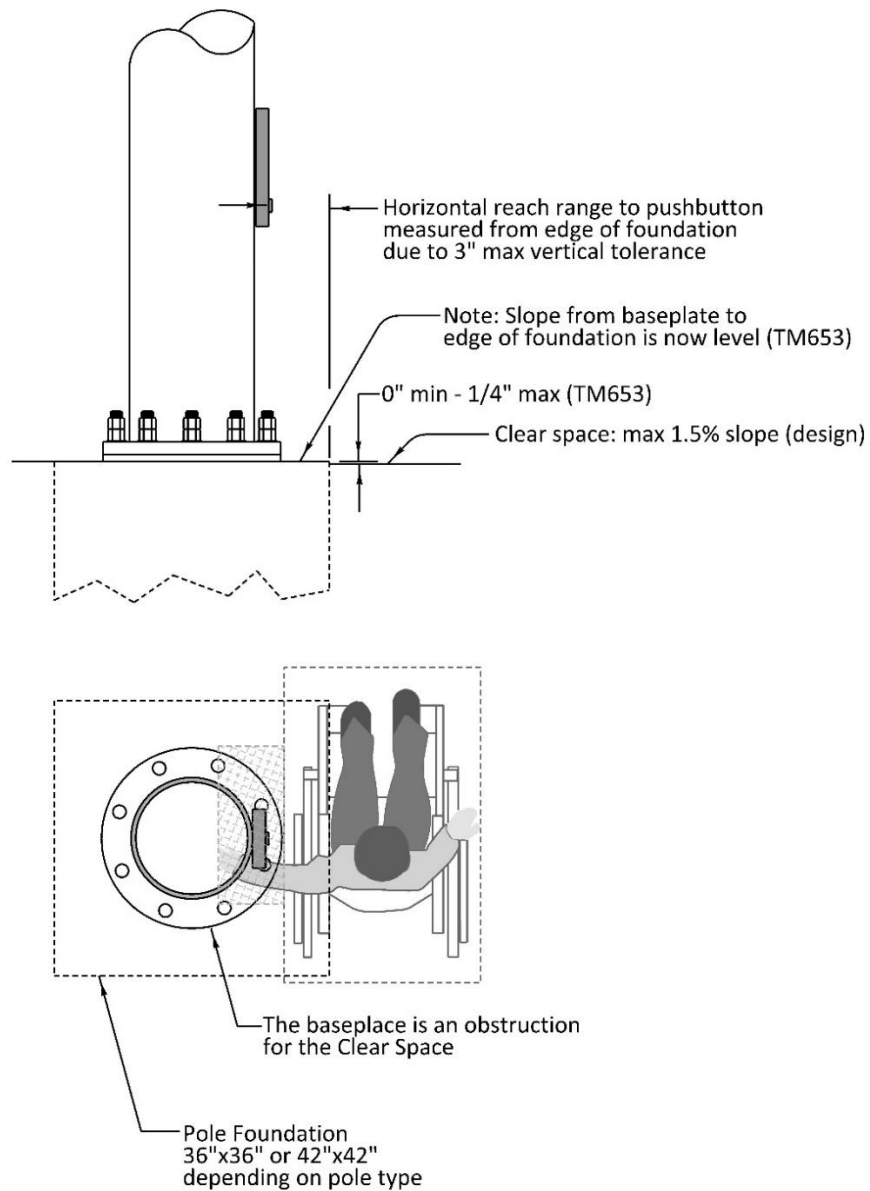
Mounting a pushbutton to a large pole limits the type of curb ramp that may be used. Typically, only a perpendicular curb ramp style will work, with a larger clear space to accommodate the back-in/head-in maneuver. See Figure 5-63. The two other curb ramp styles (parallel and combo) both include a curb which will not meet the 10-inch horizontal reach if the pole is placed behind the curb. See Figure 5-77. Unlike a pedestal foundation, it is typically not practical to place the large pole foundation in front of the curb. Integrating the pole foundation with the curb installation, to achieve the 10-inch horizontal reach, is also not recommended due to the increased the complexity of construction (requires custom design details and excellent coordination/cooperation between sub-contractors).

Figure 5-77 | Poles Located Behind Curbs Do NOT Meet 10-Inch Horizontal Reach Requirement



The foundation of the large pole is no longer an obstruction to the clear space due to recent changes to standard drawing TM653 (the slope from baseplate to edge of foundation is now level and the vertical tolerance of the foundation to the adjacent asphalt or concrete finish grade is now 0" to 1/4"). For large poles constructed after January 2020, the baseplate is the obstruction to the clear space. See Figure 5-78.

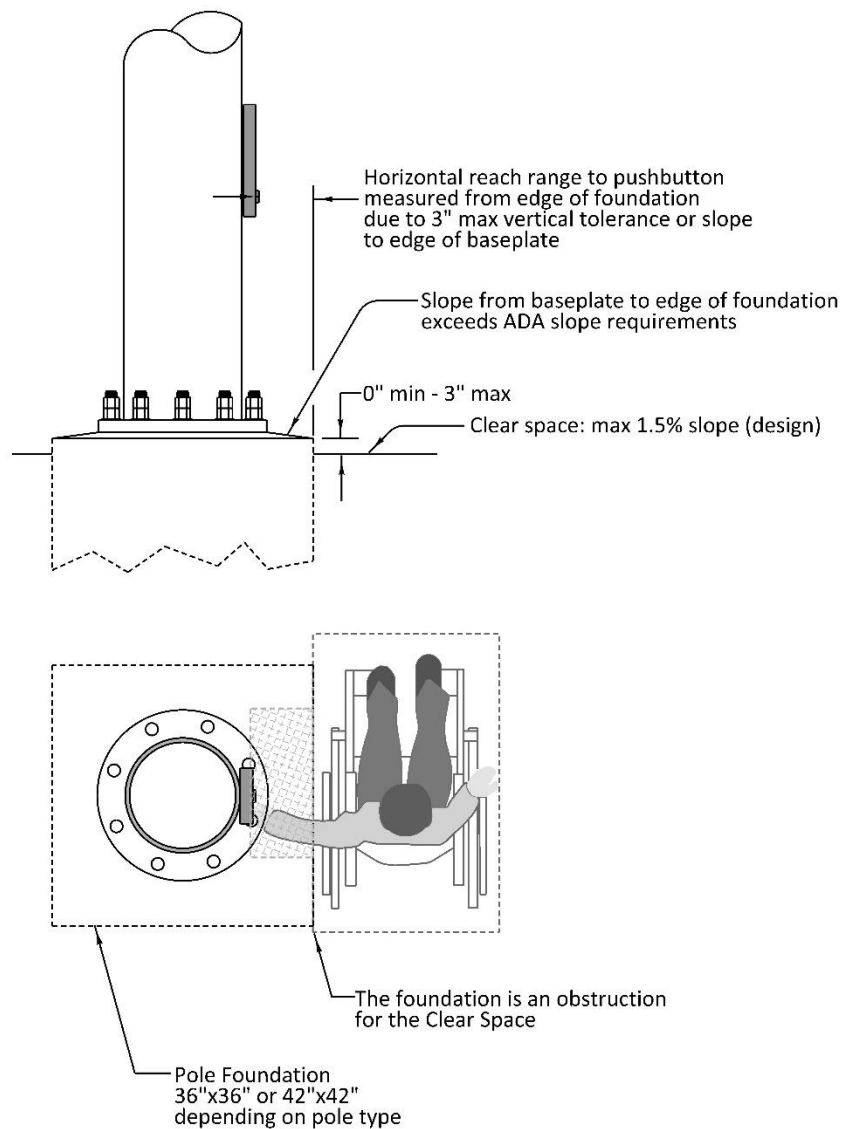
Figure 5-78 | Measuring Horizontal Reach to Pushbutton Mounted on Large Pole (POLES CONSTRUCTED AFTER JANUARY 2020)



For poles constructed before January 2020, the foundation is likely an obstruction to the clear space for two reasons (see Figure 5-79):

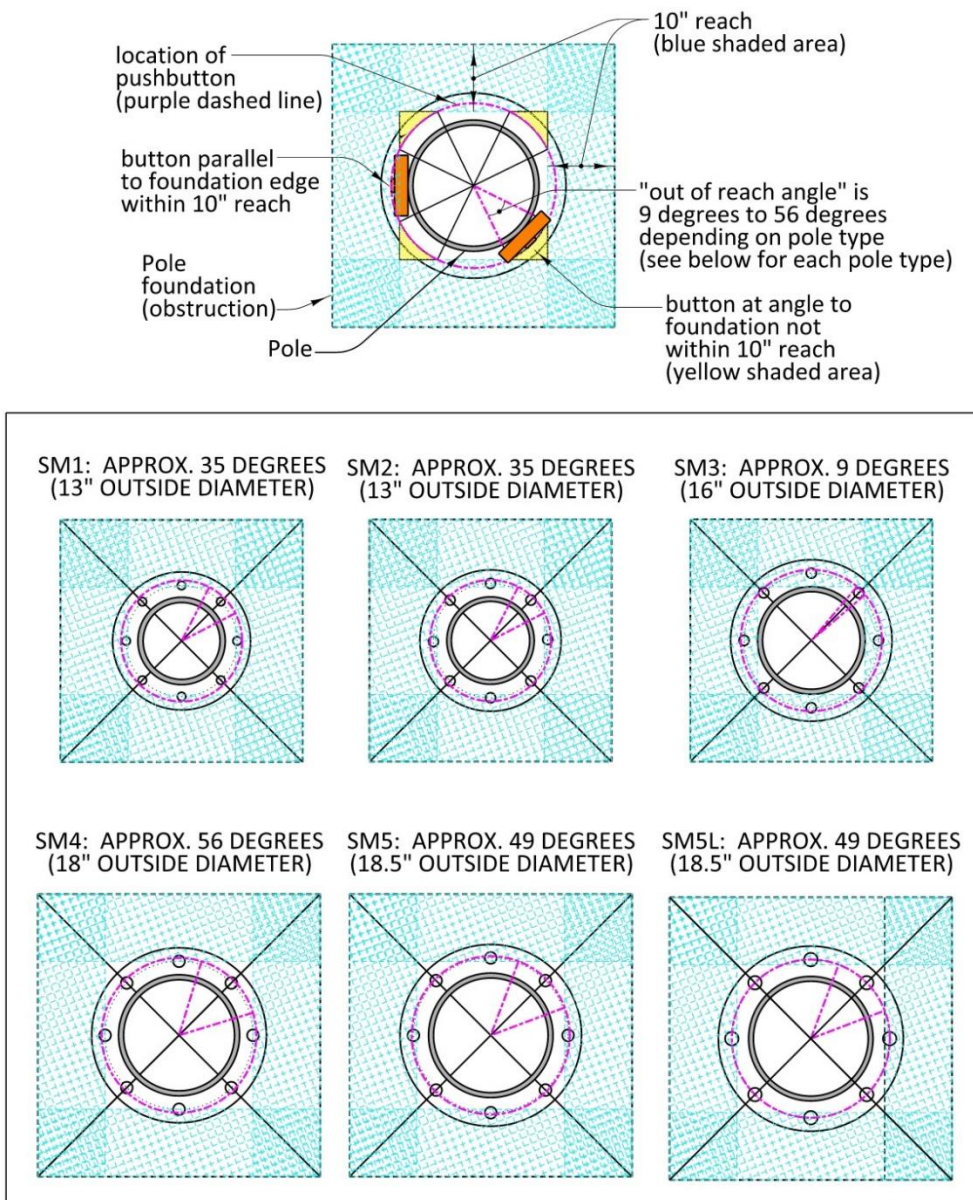
- The 3-inch max vertical tolerance for foundation exposure with respect to the adjacent finish grade, or
- The slope from the foundation control point to the edge of the baseplate exceeds ADA slope requirements.

Figure 5-79 | Measuring Horizontal Reach to Pushbutton Mounted on Large Pole (POLES CONSTRUCTED BEFORE JANUARY 2020)



For poles where the foundation is an obstruction for the clear space (poles constructed before January 2020), the reach distance measured from the edge of the signal pole foundation to the pushbutton will just barely meet the 10-inch horizontal reach for MOST all pole types and pushbuttons listed on the approved blue sheets IF THE PUSHBUTTON IS MOUNTED PARALLEL TO THE EDGE OF THE FOUNDATION. See Figure 5-79. If the pushbutton is installed at an angle to the foundation, there is a point where it will fall outside the 10-inch horizontal reach (“out-of-reach angle”). See Figure 5-80.

Figure 5-80 | Out-of-Reach Angle for Pushbuttons Located on Large Poles (POLES CONSTRUCTED BEFORE JANUARY 2020)



## 5.4.6 Deviation: Two Pushbuttons Mounted on a Single Pedestal

Two pushbuttons on the same pedestal is the preferred solution for two scenarios:

- For two curb ramps that share a single turning space
- When an ADA curb ramp design exception has been granted for a diagonal curb ramp (one curb ramp that will serve two crosswalks)

Trying to accommodate the 8-foot pushbutton separation for these two scenarios is not recommended due to the following drawbacks:

- The turning space and the clear space would be separated by a large distance. This creates a longer (and unnecessary) path for the wheelchair user in certain directions. For example, a parallel style diagonal curb ramp the wheelchair user would have to traverse the 7.5% slope three times if approached from a certain direction. See Figure 5-81
- Unable to meet the MUTCD requirement of 60 inch maximum from the outside edge of the crosswalk striping to the pushbutton in most cases. When pedestrian signal indications are mounted on the same pedestal as the pushbutton, they would likely be blocked from the pedestrian's view by cars stopped at the intersection. See Figure 5-81.
- If the pushbuttons are placed adjacent to the turning space (so that the clear space will coincide with or overlap the turning space), typically only 5 to 6 feet of separation can be achieved. Short separation distances are not desirable as they can create an "obstacle course" on the sidewalk that may be difficult for the sight impaired to navigate. See Figure 5-82.

Note that the MUTCD section 4E.08 states that the pushbuttons should be separated by 10 feet and allows the pushbuttons to be placed closer or on the same pole when it is impractical to achieve the 10-foot separation. While it is desirable to follow the MUTCD guidance and separate the pushbuttons by 10 feet, we have encountered enough locations where pushbutton separation between 8 to 10 feet provides the best access to the pushbuttons within the site constraints. Pushbutton separation of 8 to 10 feet still allows a reasonable amount of separation to avoid creating an "obstacle course" and alternative audible pedestrian messages for buttons less than 10 feet apart are allowed as per the MUTCD. Therefore, ODOT allows a minimum pushbutton separation of 8 feet. If it is not feasible to separate the pushbutton 8 feet, both pushbuttons should be mounted on a single pedestal.

Figure 5-81 | Drawbacks to the 10-foot Separation of Pushbuttons at Diagonal Curb Ramps

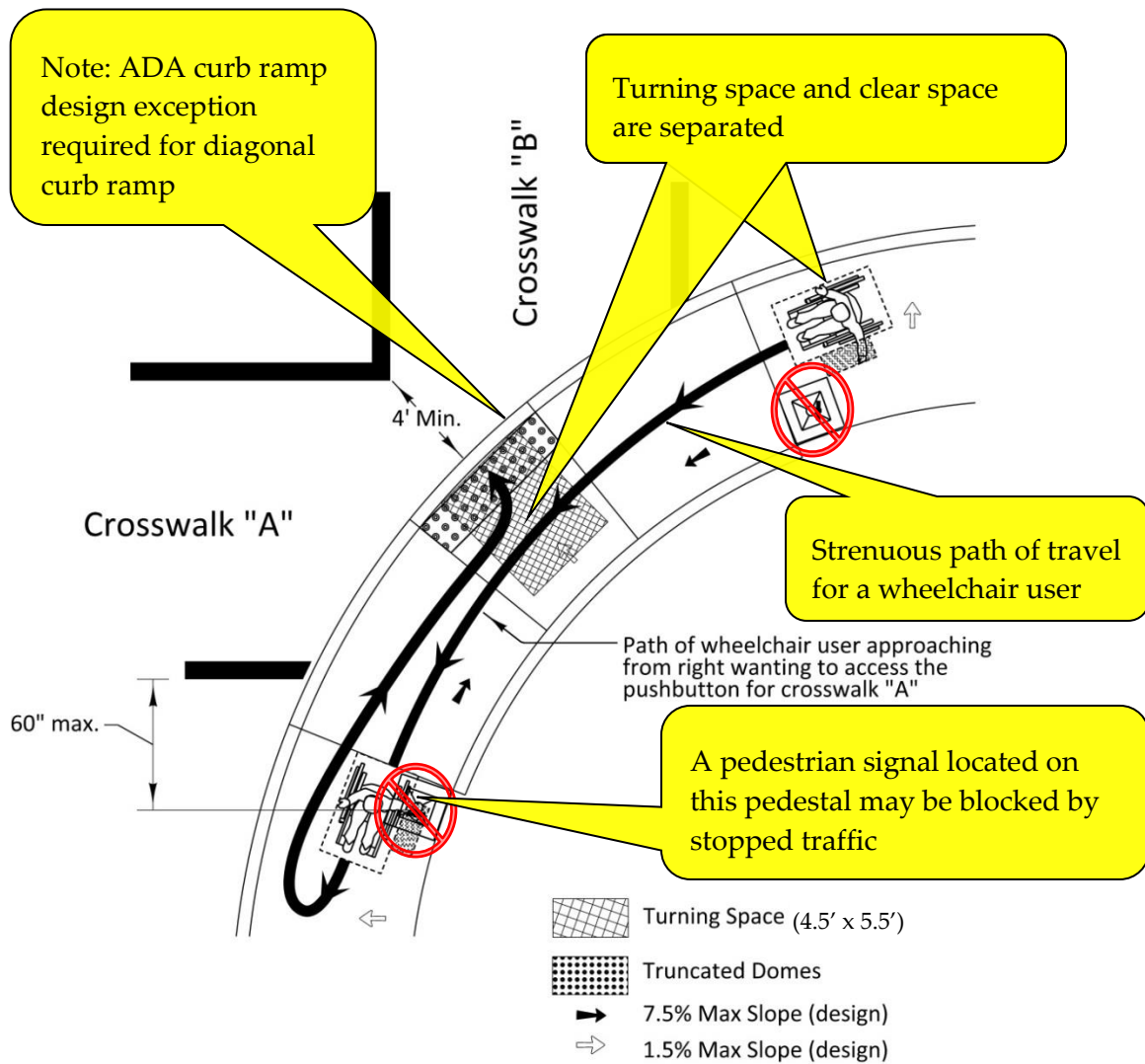
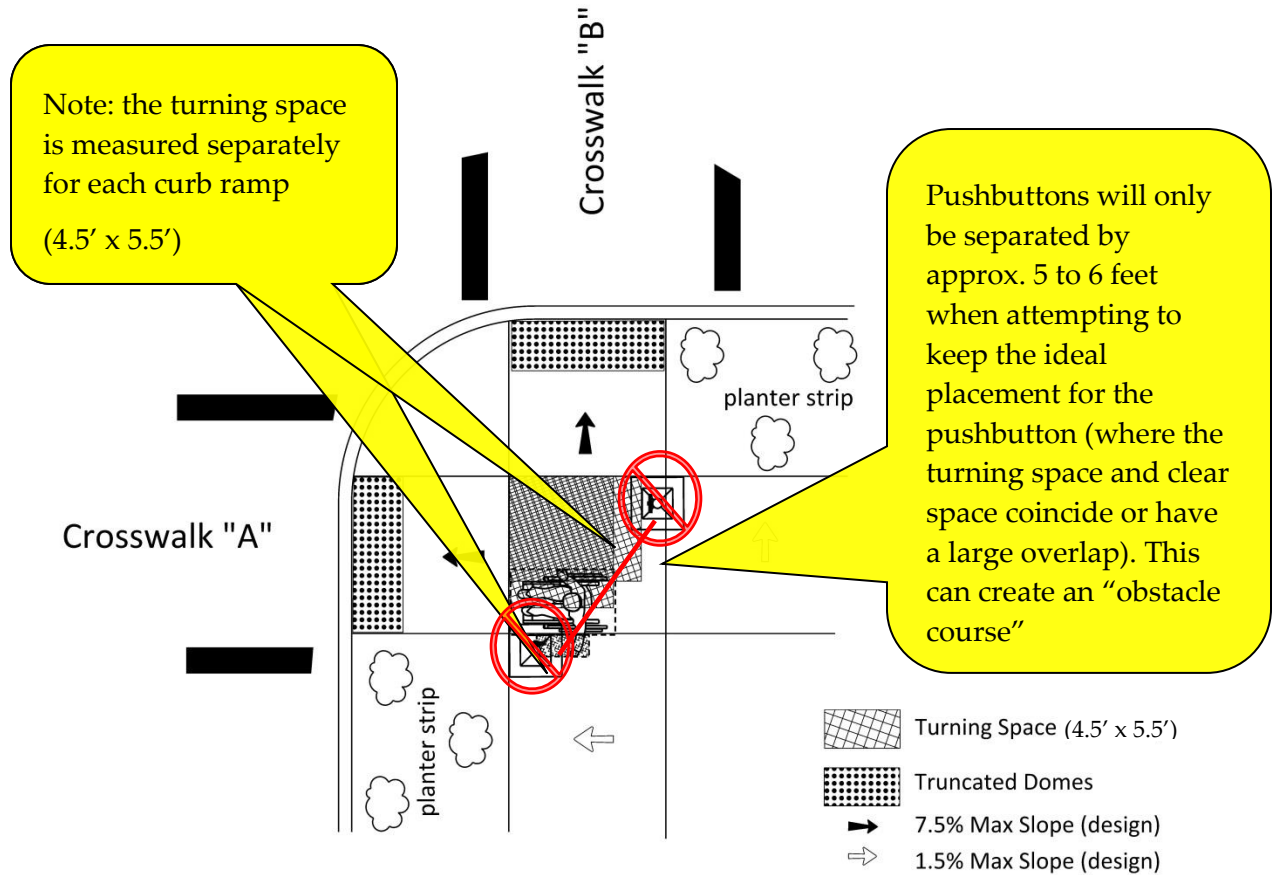




Figure 5-82 | Drawbacks to the 10-foot Separation of Pushbuttons at Two Curb Ramps That Share a Turning Space



See Figure 5-83 for an example of the preferred placement for two curb ramps that share single turning space and Figure 5-84 through Figure 5-87 for the preferred placement for common styles of diagonal curb ramps.

Figure 5-83 | Preferred Pushbutton Placement for Two Curb Ramps That Share a Turning Space (Two Buttons on Pedestal)

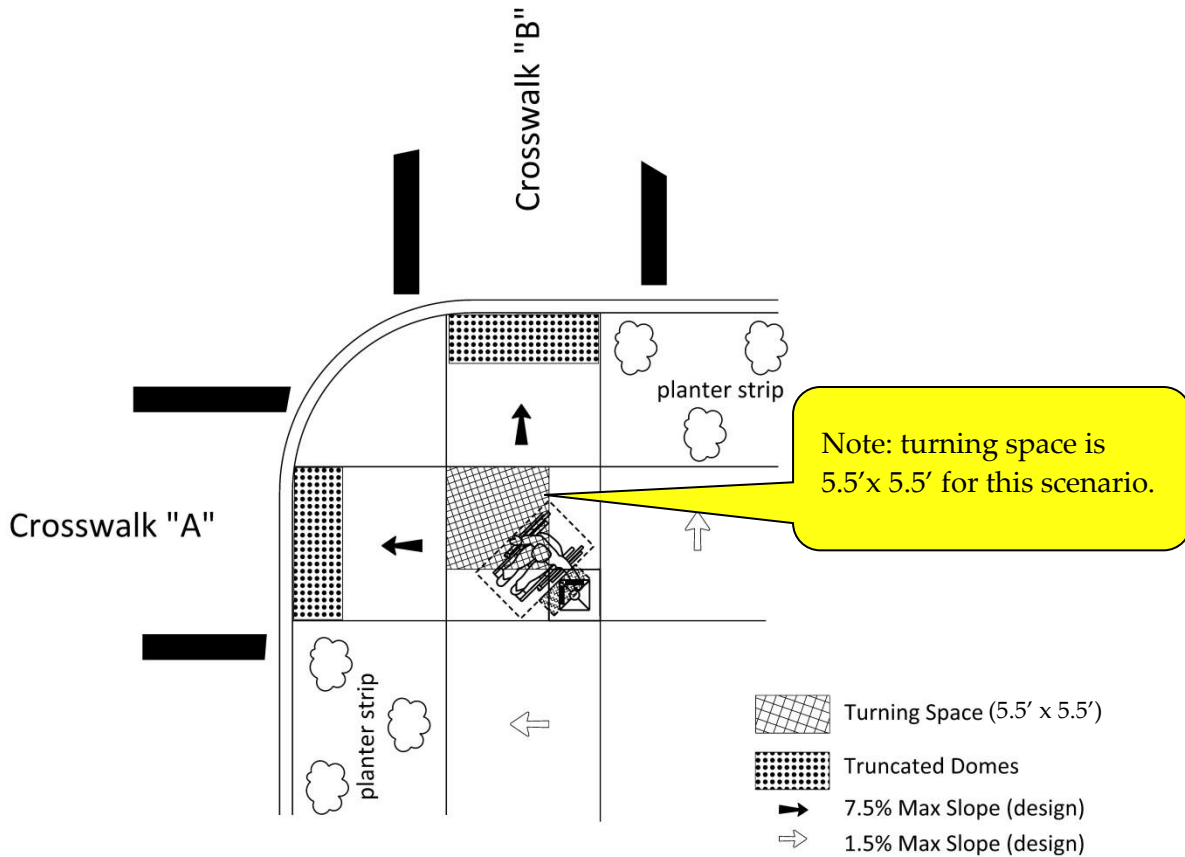


Figure 5-84 | Preferred Pushbutton Placement for Diagonal Perpendicular Style Curb Ramp (Two Buttons on Pedestal)

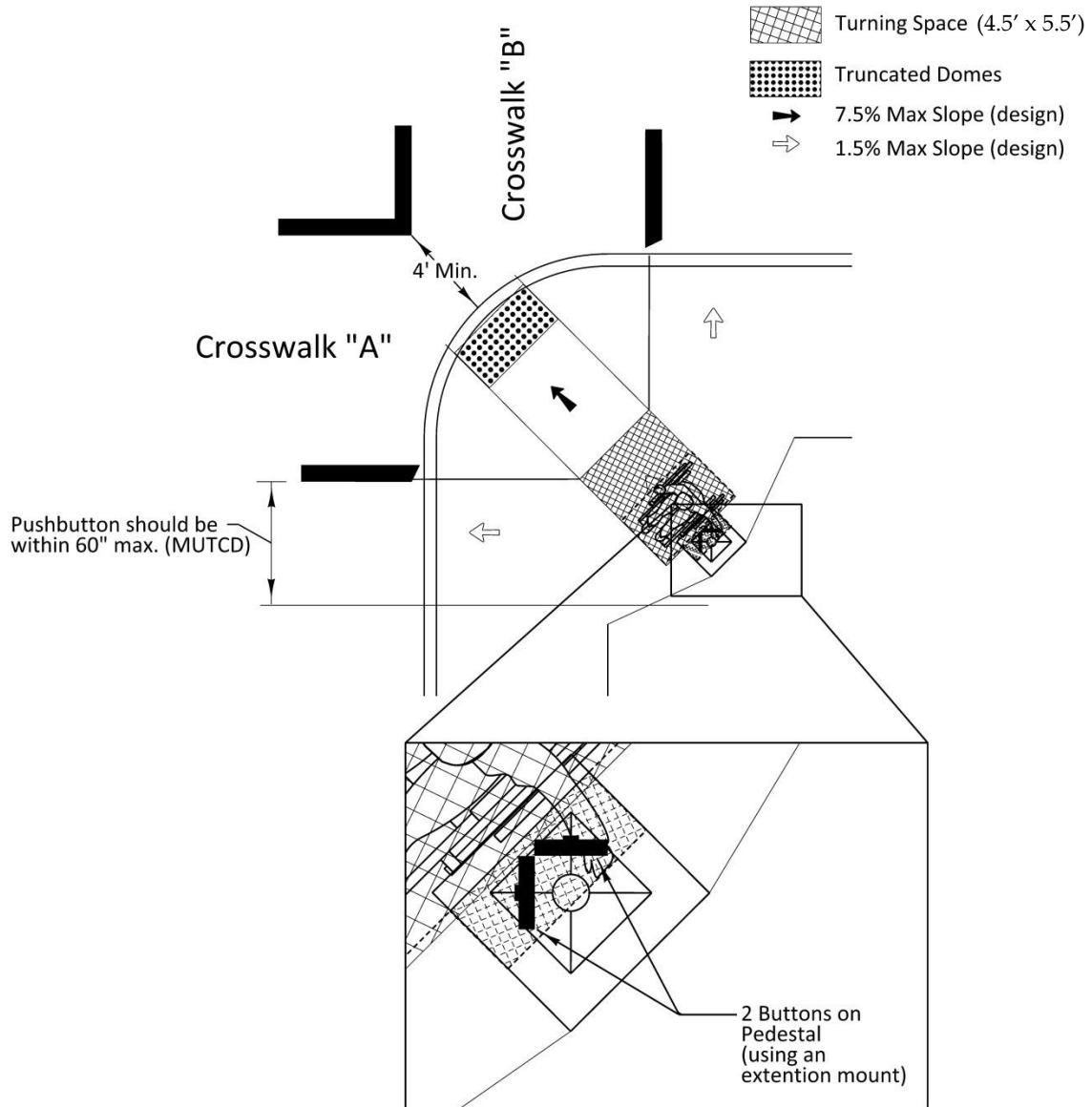


Figure 5-85 | Preferred Pushbutton Placement for Diagonal Parallel Style Curb Ramp (Two Buttons on Pedestal) – Example 1

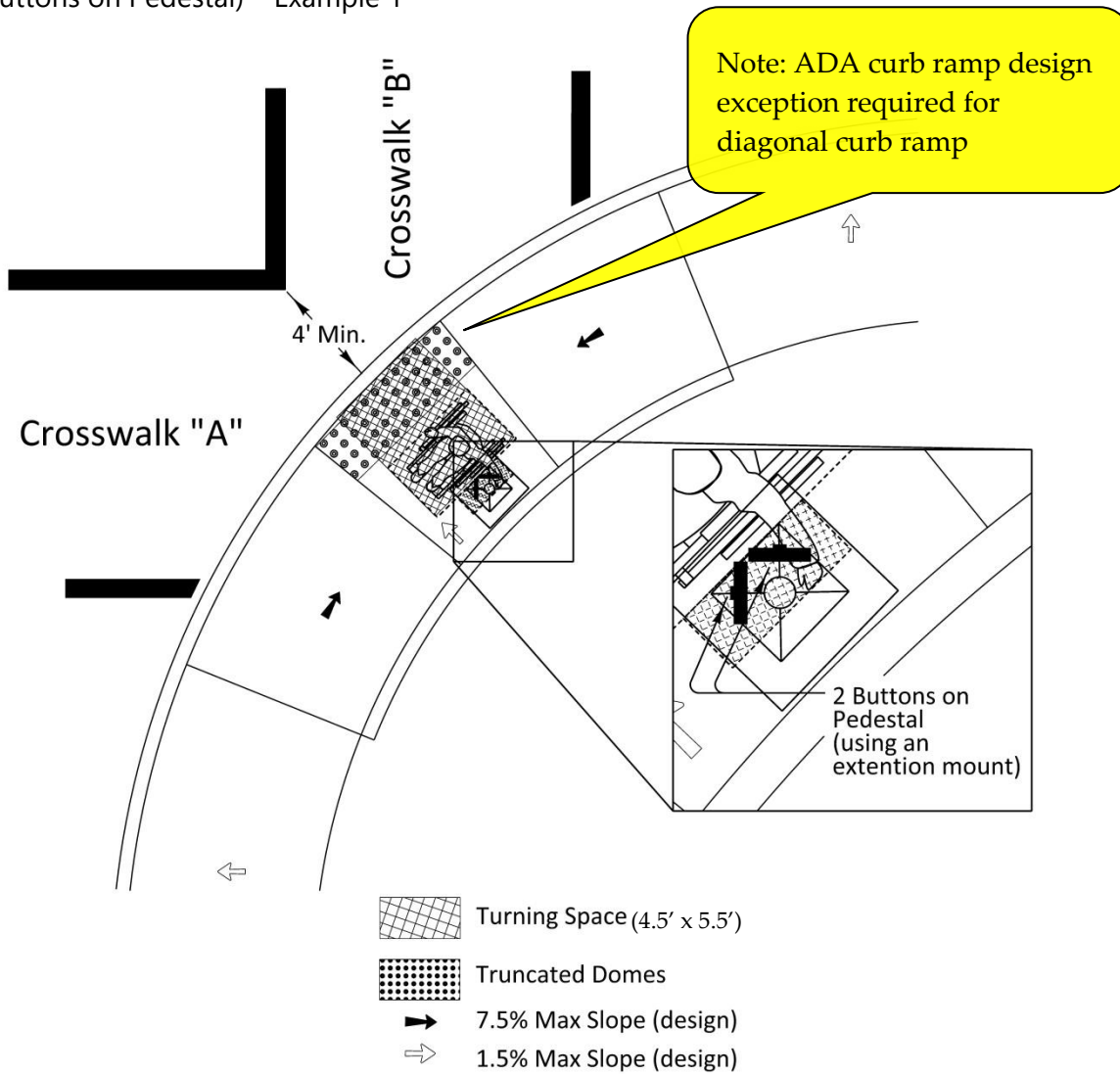


Figure 5-86 | Preferred Pushbutton Placement for Diagonal Parallel Style Curb Ramp (Two Buttons on Pedestal) – Example 2

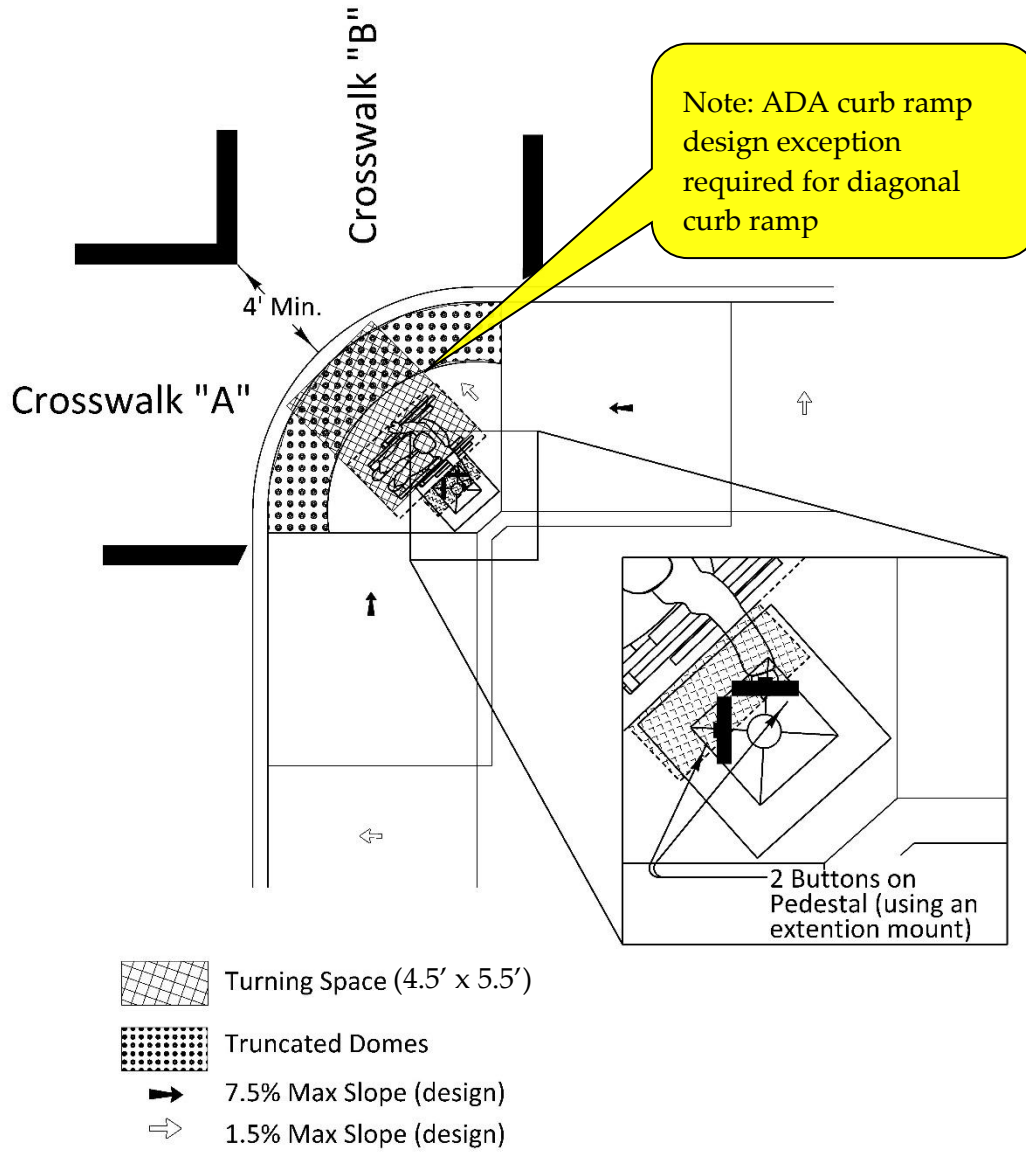
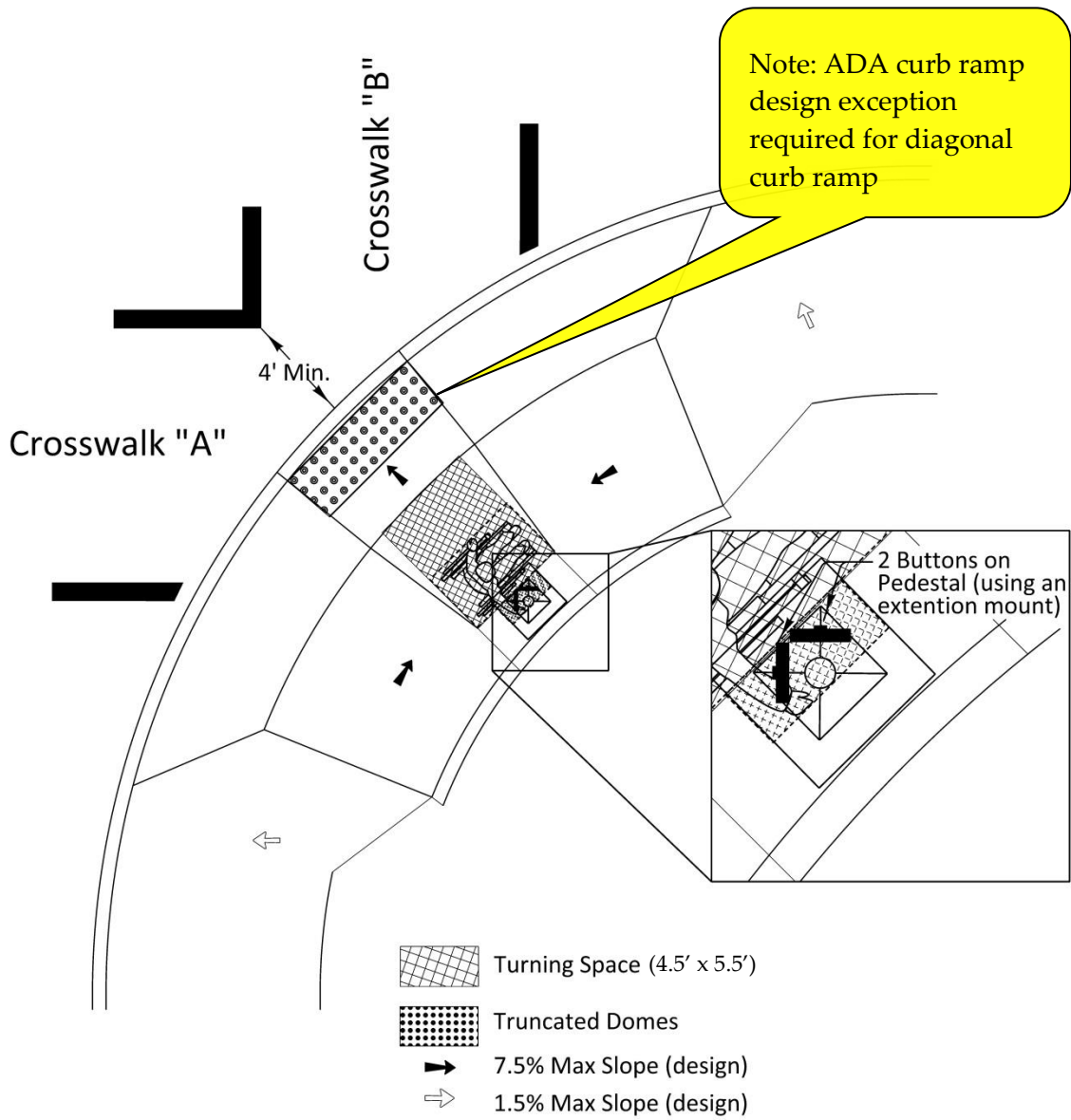


Figure 5-87 | Preferred Pushbutton Placement for Diagonal Combo Style Curb Ramp (Two Buttons on Pedestal)



Several items need extra attention when a diagonal curb ramp serves two crosswalks. Verify the following:

- The pushbutton is located within 60 inches of the outside edge of the crosswalk striping. See Figure 5-88.
- The location of the pedestrian indications will not be blocked by from view by traffic stopped at the stop line. This can be challenging when the radius is small. Advance stop lines may be an appropriate solution to preserve the pedestrian’s line of sight to the pedestrian indications.
- There is 4’ minimum between the curb ramp and the inside crosswalk striping. This distance provides the wheelchair user a location to maneuver to the desired crosswalk and should be outside of the travel way (including bike lanes). Note that meeting this 4’ minimum dimension may not be possible with a small radius. See Figure 5-89.

Figure 5-88 | Pushbutton 60” From Outside Edge of Crosswalk Striping at Diagonal Curb Ramp

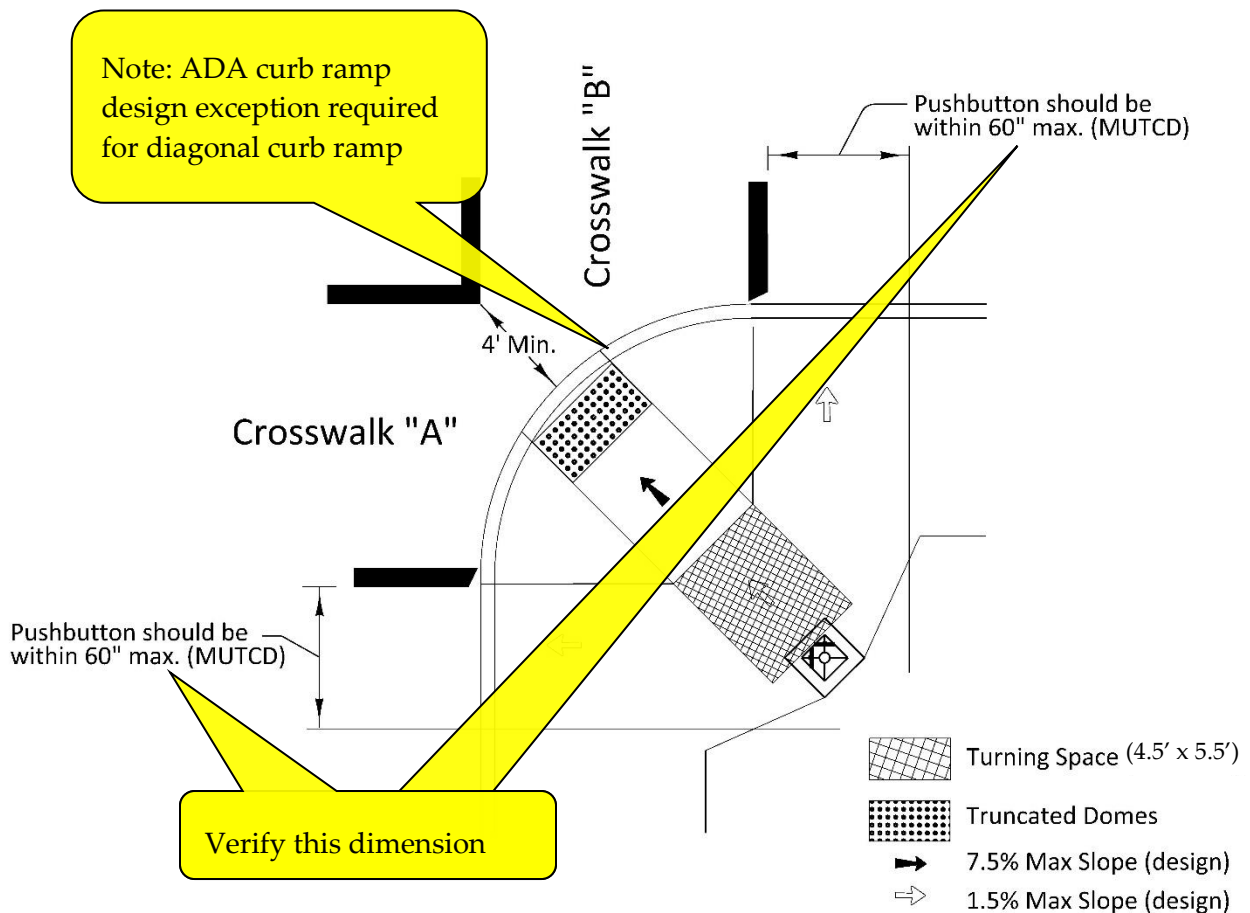
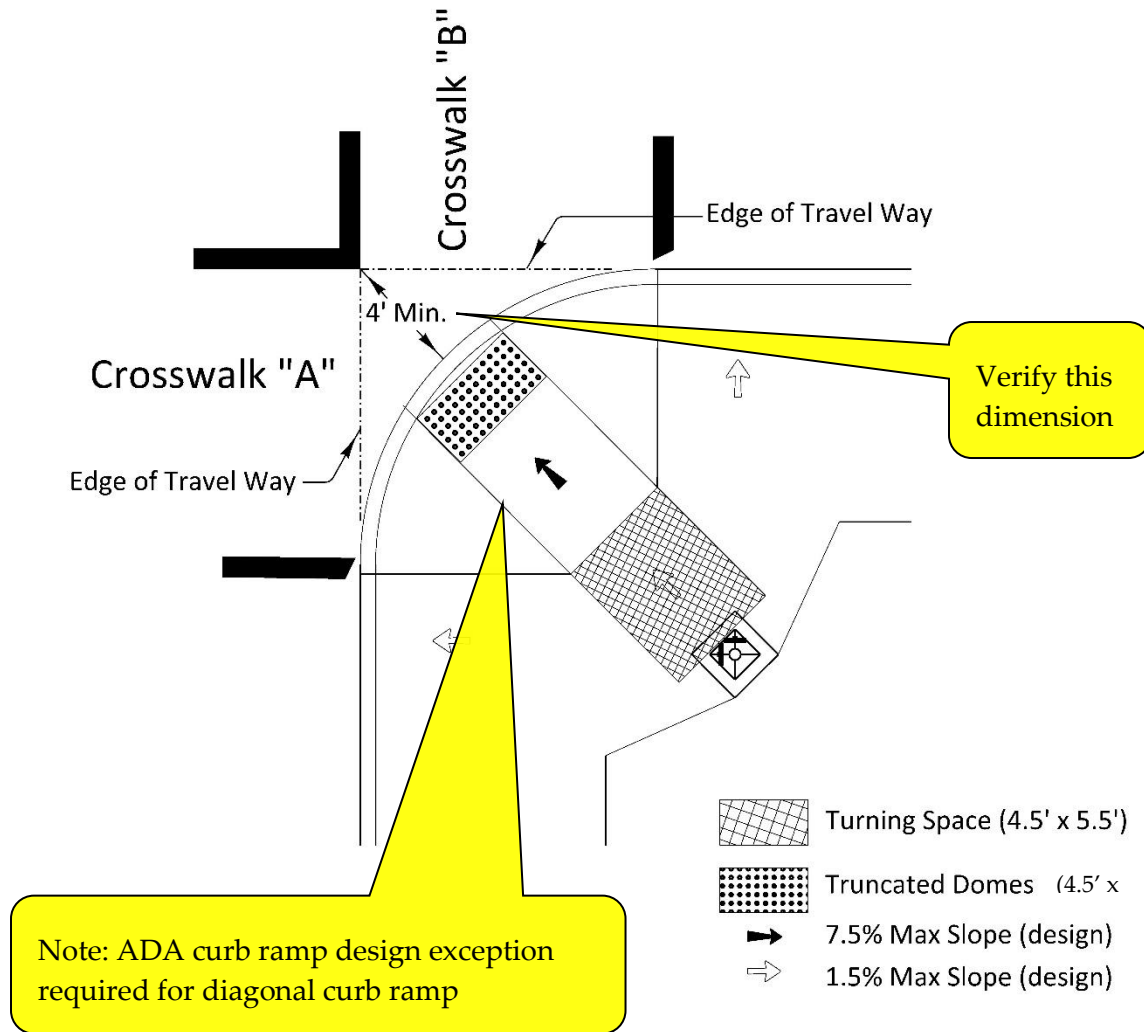


Figure 5-89 | 4' Minimum Distance Between Curb Ramp and Inside of Crosswalk Striping at Diagonal Ramp





## 5.4.7 Deviation: Use of an Extension Bracket Mount

Pushbuttons mounted on extensions are discouraged due to the potential for increased maintenance problems and they can also be a potential hazard for pedestrians if they protrude into the clear circulation path. The extension bracket should not be longer than 12 inches to minimize damage caused from improper use (e.g., pedestrian sitting/leaning/pushing/pulling on the extension bracket). Pushbuttons using an extension bracket may not extend more than 4 inches into the clear circulation path (see standard drawing RD720). As such, they should only be used in two specific cases:

- When two pushbuttons must be mounted on 4" diameter pole, as required by TM467. See Figure 5-90.
- Retro-fitting existing installations that do not meet the 10-inch horizontal reach due to a detectable obstacle located on the ground (typically a curb). See Figure 5-91 and Figure 5-92. Do NOT use an extension bracket if reach cannot be obtained due to a slope (as the bracket will protrude more than 4 inches into the circulation path as shown in Figure 5-93).

Figure 5-90 | Extension Bracket Mount for Two Pushbuttons on 4 Inch Diameter Pole



Figure 5-91 | Extension Bracket Mount Example – Standard Button Style



Figure 5-92 | Extension Bracket Mount Example – H-Frame



Figure 5-93 | Extension Bracket Mount Photoshop Example – Extending More Than 4 Inches into the Pedestrian Circulation Path



## 5.4.8 Deviation: Vertical Reach of Pushbutton

The traffic signal standard drawings state the pushbutton vertical mounting height is 42" to 48". This height should work for most installations. However, the PROWAG requirements allow mounting heights from 15" to 48" to accommodate a wide variety of users and applications. At locations where a request has been made or high volume of children are expected to use the pushbuttons, it may be beneficial to mount the pushbutton slightly lower at 36" rather than the standard location shown on the standard drawings.

While the PROWAG requirements allow placement down to 15", mounting pushbuttons below 36" begins to become less accessible for a large portion of users (requiring them to stoop down to use the pushbutton) and is not recommended. In cases where a mounting height of lower than 36" is necessary to accommodate a user (e.g., access via a wheelchair foot rest), consider the following solutions:

- The use of two pushbuttons (one mounted at the standard height and one mounted at the requested height). See Figure 5-94.
- The use of passive pedestrian detection
- The use of recalled pedestrian phases

Work with the state traffic signal engineer when considering a vertical reach deviation to determine the proper site-specific solution. Deviations to mounting height should be shown on the signal plan sheets with a prominent, custom note. Highlighting this deviation to the project manager's office and contractor is also recommended during the pre-construction meeting.

Figure 5-94 | Deviation to Vertical Reach Example



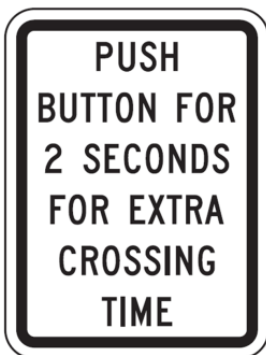
### 5.4.9 Pushbuttons Located Behind Guardrail

While not ideal, pushbuttons may be located behind guardrail if they meet the criteria specified in section 5.4.2. This can be accomplished by positioning the pedestal between the guardrail posts. Additional coordination between the guardrail installer and the signal installer during construction will be necessary to ensure compliance.

### 5.4.10 Extended Pushbutton Press Feature

The extended pushbutton press feature provides slower pedestrians an opportunity to request and receive a longer pedestrian clearance time. The region signal operations engineer will determine if this feature is needed. If this feature is used, an additional sign PUSH BUTTON FOR 2 SECONDS FOR EXTRA CROSSING TIME (R10-32P) is required to be mounted adjacent to the pedestrian pushbutton (see Figure 5-95). The Oregon specific sign shown in Figure 5-96 combines the two required federal signs and is preferred over installing the two federal signs.

Figure 5-95 | Extra Crossing Time Sign R10-32P



R10-32P

Figure 5-96 | Extra Crossing Time Sign OR-32



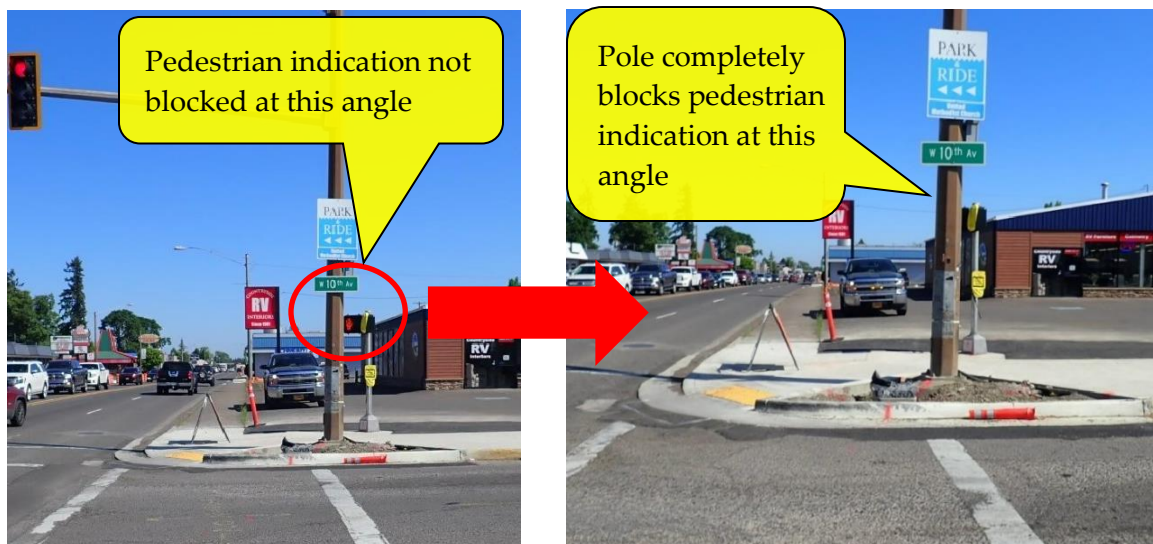
### 5.4.11 Pedestrian Signal Location

All pedestrian signals shall have clear line of sight from within the crosswalk lines from one end of the crosswalk to the pedestrian signal at the other end of the crosswalk. See Figure 5-97. Verify the pedestrian signal will be visible the entire length of the crossing. This is best accomplished by ensuring there are no potential obstructions located in front of the pedestrian signal. See Figure 5-98. Potential obstructions can also include vehicles properly stopped at the crosswalk line.

Figure 5-97 | Good Pedestrian Signal Visibility

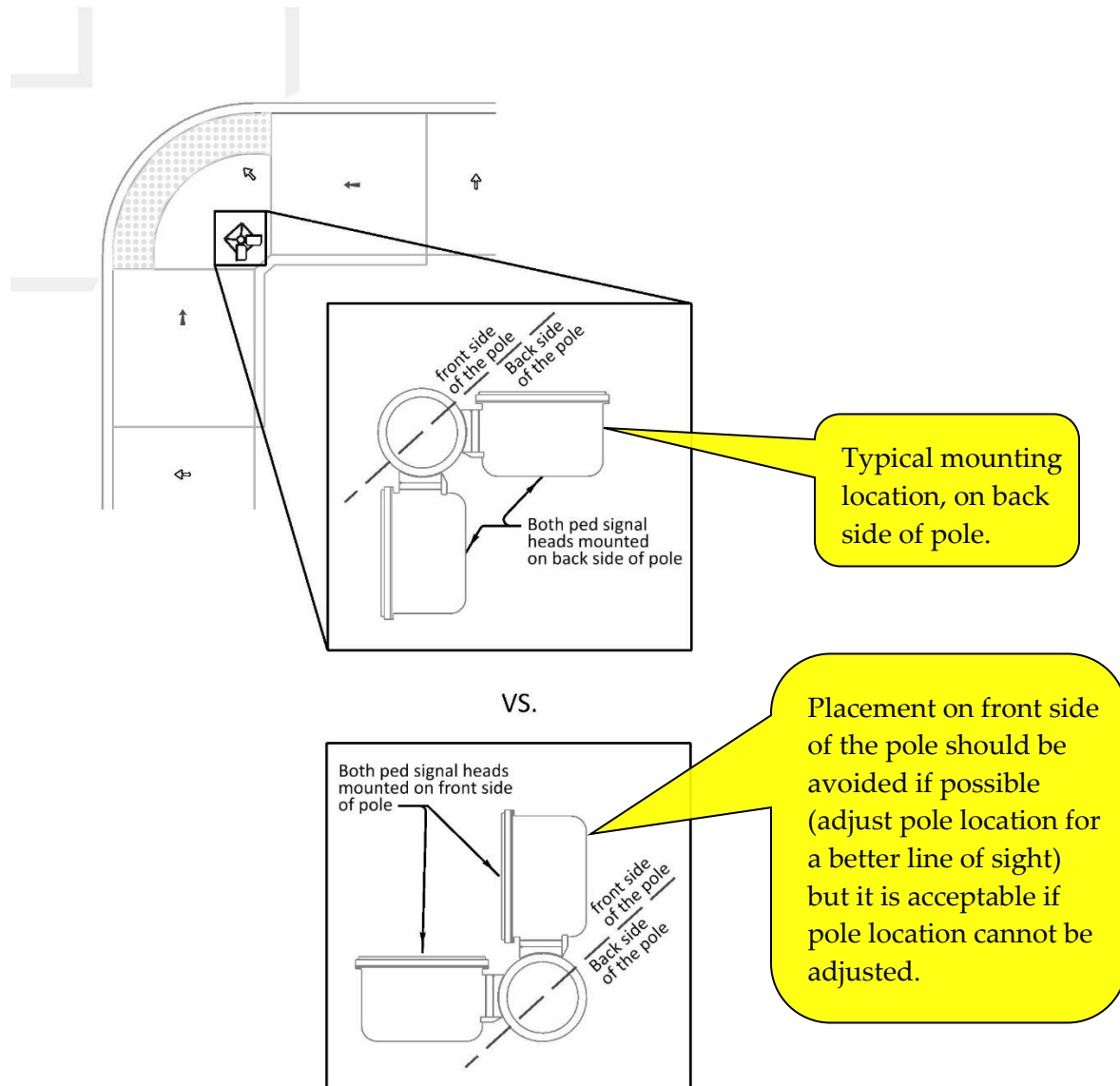


Figure 5-98 | Poor Pedestrian Signal Visibility



Typically, the orientation of the pedestrian signal head is placed on the back side of the pole/pedestal. This results in slightly more room for the swept path of a large truck making a right turn, lowering the risk of the pedestrian signal head getting hit and damaged. However, pedestrian signal heads should be placed on the front side of the pole if it will improve the line of sight to the indication AND the pedestal/pole location cannot be adjusted. See Figure 5-99.

Figure 5-99 | Pedestrian signal orientation (back side vs. front side)

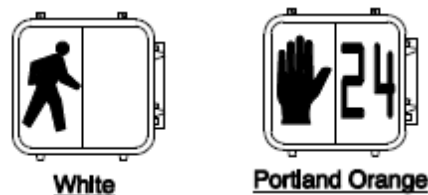


For retro-fit projects where the existing pedestrian signal head is a candidate to remain in place, verify the angle/aim of pedestrian signal head is appropriate for the proposed new ramp and crosswalk alignment. There is a high probability that the existing pedestrian signal head will require adjustment and if that is the case, a new pedestrian head at the correct angle should be installed (vs. re-mounting the existing pedestrian signal head).

## 5.4.12 Indication Type

All pedestrian signal indications shall be the countdown type. See Figure 5-100. If the scope of the project necessitates the need to install only one new pedestrian signal indication but there are other existing non-countdown pedestrian signal indications at the intersection, all pedestrian signal indications for the entire intersection should be updated.

Figure 5-100 | Countdown Pedestrian Signal Indications



## 5.4.13 Audible Pedestrian Signals

The operational approval for the traffic signal will state if audible pedestrian signals are required. Verify with the region traffic engineer. See the ODOT Traffic Signal Policy and Guidelines for additional information.

## 5.5 Pole Selection and Placement

Mast arm poles are the standard for all new signal and retrofit installations. Span wire installations are no longer allowed for permanent signals. Custom supports (such as bridge or sign structures) should only be considered if standard supports are not feasible.

### 5.5.1 Right-of-Way

All equipment (including foundations) must be located within right-of-way or permanent easements and shall not overhang private property.

### 5.5.2 Overhead Structures and Vertical Clearance Standards

Contact the region mobility liaison when any proposed project (new construction, reconstruction, preservation, or maintenance) adds a new or modifies an existing overhead structure (truss sign bridge, monotube cantilever, signal mast arm, and signal strain pole) regardless of meeting the existing minimum vertical clearance standards. In addition, contact the region mobility liaison for any project that reduces the existing vertical clearance regardless of meeting the minimum vertical clearance standards. The region mobility liaison will provide the appropriate coordination with the region, and MCTD. This coordination should address not only project specific mobility requirements, but also any corridor level vertical clearance and



mobility needs. Vertical clearance greater than 19'-0" for sign, VMS, and signal support structures are considered non-standard and require a design exception. The signal designer is to follow the procedures outlined in chapter 14 of the ODOT Highway Design Manual. The design exception request process for increasing the vertical clearance greater than the above mentioned 19'-0" will need to consider safety, operations, and impact to other design features to support the approval of the design exception.

### 5.5.3 Height Restrictions

When working on signals located near airports, there is the possibility of height restrictions which can have an impact on pole selection, especially poles with illumination. Check with the airport regarding flight paths and height restrictions.

### 5.5.4 Utility Conflicts

Always verify the possibility of overhead and underground utility conflicts when locating poles. Conflicts with overhead and underground utilities will need to be addressed during the design of the signal and resolved before the design is complete.

A minimum of 10 feet from overhead high voltage lines is required as per OAR 437-002-0047. For low voltage lines (e.g., communication, fiber optic, cable, etc.), the following minimum clearances should be provided (see Figure 5-101):

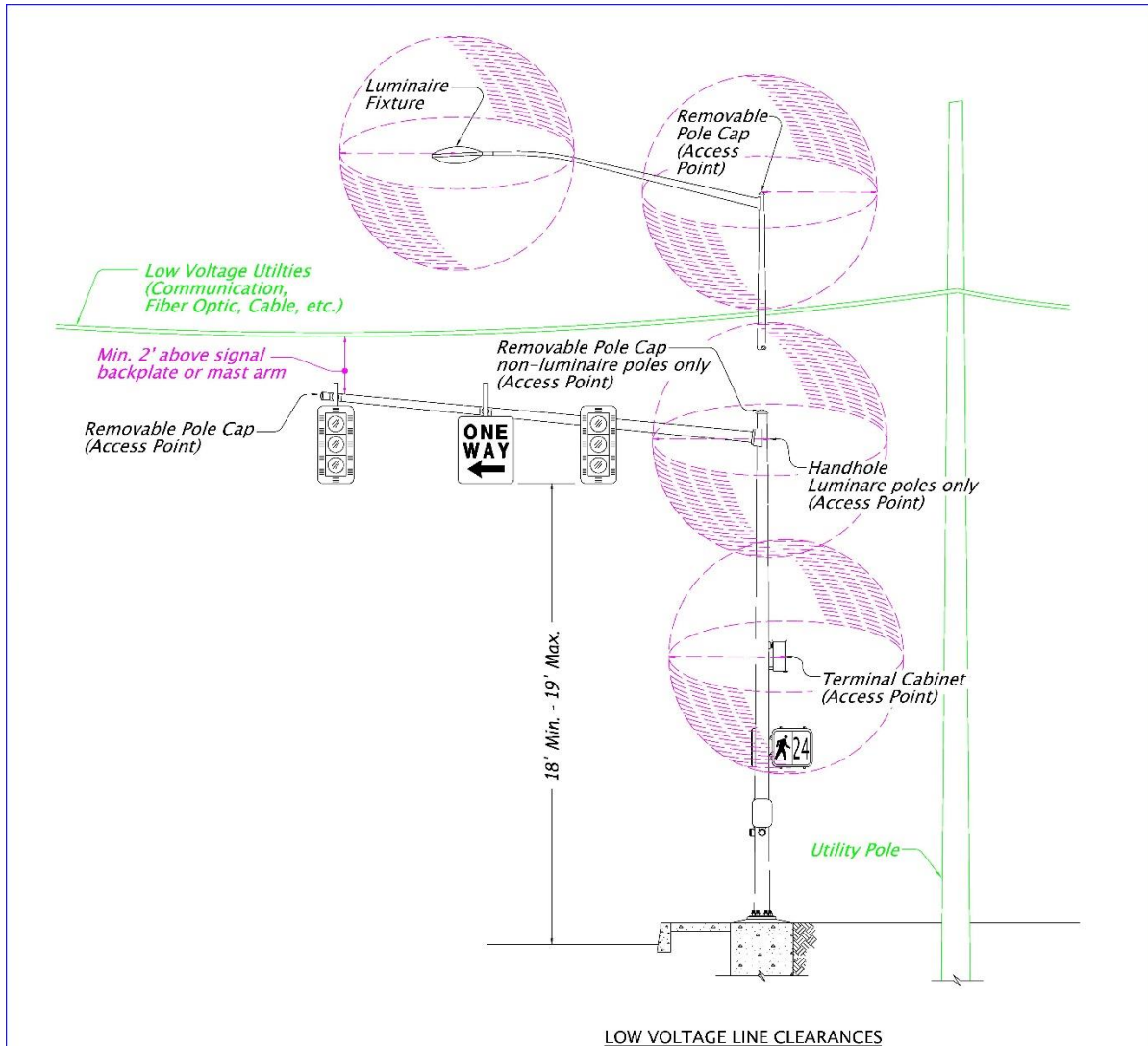
- A minimum of 5 feet from access points (e.g., removable pole caps, handholes, and terminal cabinets) and illumination fixtures
- A minimum of 2 feet from above the mast arm or backplates

The minimums shown in Figure 5-101 meet and exceed the National Electric Safety Code (NESC) requirements for low voltage lines, which typically will have a minimum clearance requirement of 2 foot vertical and 3 foot horizontal. In cases where it is not feasible to obtain the desired clearances shown in Figure 5-101, clearances that meet the minimum requirements of the NESC may be used with agreement from the utility company and the region electrical crew. Note: the NESC typically applies only to utilities (providing power), which is different than the National Electric Code which typically applies to electricians (using the power provided from the utility).

Verify the utility's clearance requirements when placing any signal equipment within 10 feet of a utility pole/cable/cabinet. The region utility specialist will facilitate this communication and provide help if there are any conflicts. See chapter 8 for more detailed information about identifying conflicts and working with the region utility specialist. There are three possible solutions depending on the situation:

1. The signal pole location may need to be adjusted;
2. The utility may need to be relocated; or
3. A combination of number one and two.

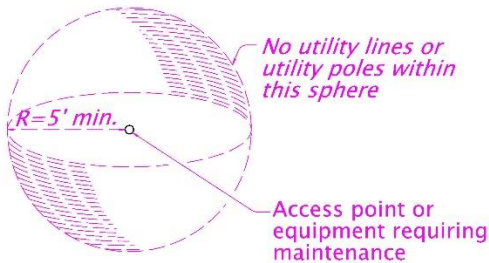
Figure 5-101 | Low Voltage Utility Clearances



LOW VOLTAGE LINE CLEARANCES

GENERAL NOTES:

1. Clearance of access points such as removable pole caps, handholes, terminal cabinets and equipment such as luminaire fixtures should be as shown to allow for maintenance activities.
2. Clearance above signal backplate shall be as shown to allow for unobstructed view of signal head indications and maintenance activities and meet NEC requirements.
3. Verify utility provider clearances. Use utility provider clearances if greater than these.
4. Clearances shown apply only to low voltage utilities. For high voltage utilities, follow clearance requirements set forth in OAR 437-002-0047

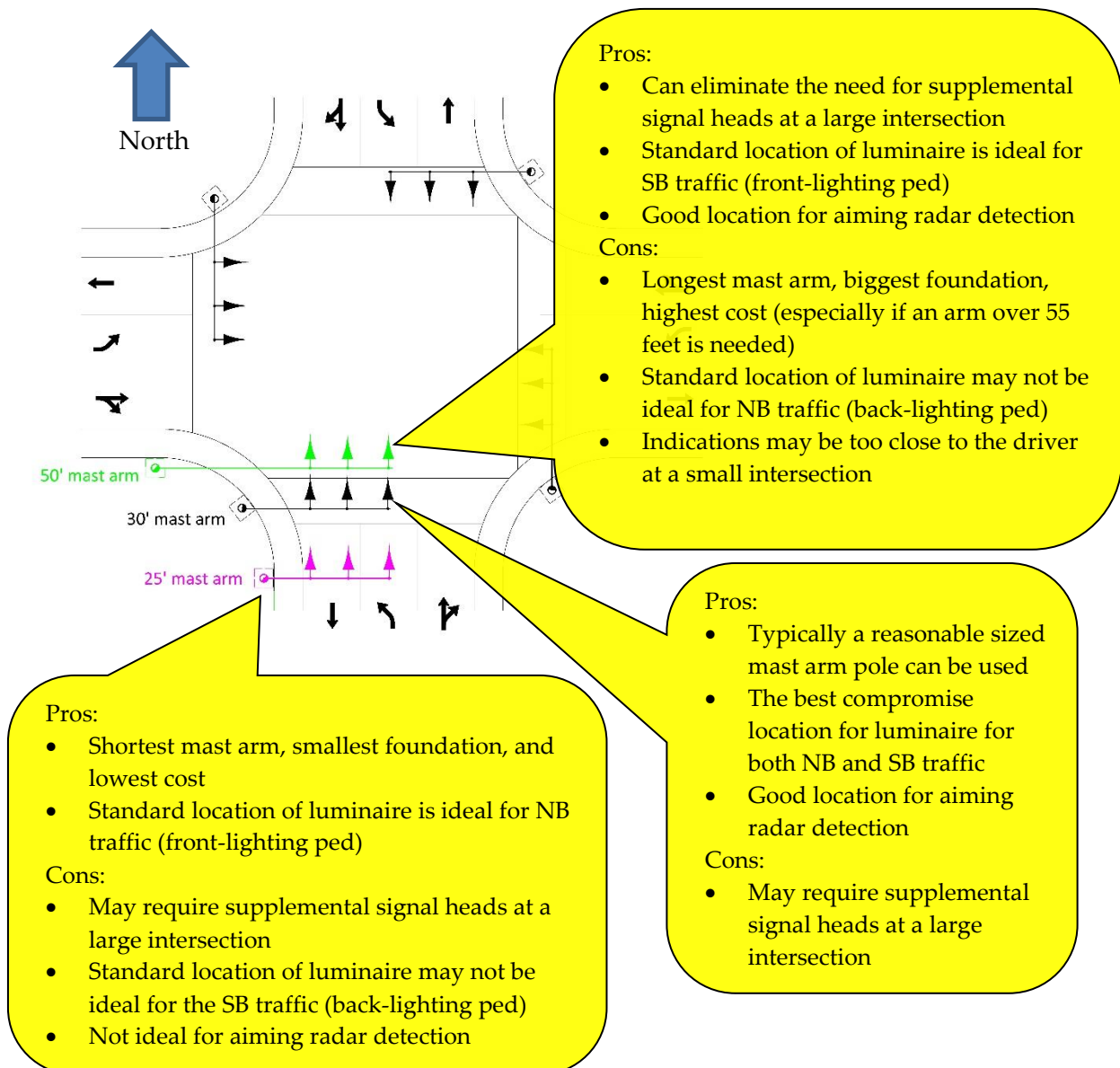


## 5.5.5 Roadside Placement Requirements

Traffic signal poles shall be located no closer than 5 feet from face of curb to the face of pole or 6 feet from normal edge of pavement when curb is not present. Poles may be located in raised islands if 5 feet clearance can be maintained on all sides of the pole.

Now that pushbuttons, and even pedestrian signals, are typically not installed on the mast arm pole anymore, there is more freedom to locate the mast arm pole anywhere near or along the radius. There are pros and cons for each of the three typical mast arm pole location as shown in Figure 5-102 that should be considered if you have the fortune of being able to locate the mast arm pole anywhere near or along the radius.

Figure 5-102 | Typical Mast Arm Pole Locations (Pros and Cons)



## 5.5.6 Mast Arm Poles

Mast arms come in sizes ranging from 15 feet to 75 feet in 5-foot increments. Mast arms that are 60 feet to 75 feet were added as a standard option in 2019 to replace span wire installations. These longer mast arms have a bigger foundation and are more expensive than mast arms less than 60 feet. As such, the signal designer should strive to use mast arms less than 60 feet whenever possible. Also note that dual mast arms are not an option when using 60 to 75 foot mast arms. Mast arm poles are normally positioned with the mast arm perpendicular to the centerline alignment.

The furthestmost piece of equipment on the mast arm (e.g., signal head, sign, or fire preemption detector) shall be located no closer than 6 inches from the tip of the mast arm. This is measured from the centerline of the mount location (which is typically the centerline of the equipment).

Illumination is typically included on all the mast arm poles at an intersection. The orientation of the illumination (location of the illumination relative to the mast arm) is usually located in-line with the mast arm, but it can be located at any degree on a standard mast arm pole as necessary.

When designing a mast arm for permissive left turn phasing operation, the mast arm should be long enough to allow proper placement of a future left turn signal head for protected only or protected/permitted operation.

Pedestrian signals and pushbuttons should not be mounted to a mast arm pole. See section 5.4 for more information about placement of pedestrian signals and pushbuttons.

## 5.5.7 Strain Poles

Strain poles are no longer allowed for permanent installations. Mast arms that are 60 feet to 75 feet were added as a standard option in 2019 to replace permanent span wire installations. Span wire installations with wood poles are only used for temporary signals. See chapter 11 for more information on span wire/wood pole design and installation.

## 5.5.8 Vehicle Pedestals – No Longer Used

Vehicle pedestals are no longer used for new construction as per the completely revised standard drawing TM457 effective in December 2022. A frangible base (formally called a pedestrian pedestal) on a pedestal foundation no. 3 (large foundation) is now used to mount vehicle signals (and other higher equipment loading such as RRFBs). See section 5.5.9. If the project work impacts an existing vehicle pedestal, it should be replaced with the new frangible base and pedestal foundation no.3 shown in TM457.

Pedestal mounted vehicle signals shall NOT be used as a substitute for a mast arm for through movement phases. They also should not be used as a substitute for a mast arm for the stem of a T-intersection unless there is no other option (such as height limitations due to a bridge). This is because vehicle signals mounted on pedestals are only 12' high (from the ground to the bottom of the signal) which makes them not as visible, especially for vehicles in the back of a platoon,

as a standard 18' – 19' overhead mounted signal. If used at the stem of a T-intersection, additional supplemental heads may be required to mitigate the loss of visibility.

## **5.5.9 Pedestals**

Pedestals (formally called pedestrian pedestals) consist of a frangible base that can be installed on three different foundations (see TM457):

- Foundation no. 1 – small. This foundation is used only to mount pedestrian pushbuttons
- Foundation no. 2 – medium. This foundation is used only to mount pedestrian signals and pedestrian pushbuttons.
- Foundation no. 3 – large. This foundation is used to mount vehicle signals, signs, detection units, and flashing beacons/RRFBs.

See section 5.4 for more information about mounting pedestrian equipment on pedestals.

## **5.5.10 Recessed Terminal Cabinet**

Recessed terminal cabinets are the standard. Applicable standard drawings in the TM400 and TM600 series should be used.

## **5.5.11 Pushbutton Posts – No Longer Used**

Pushbutton posts are no longer used for new construction as per the completely revised standard drawing TM457 effective Dec. 2022. A frangible base (formally called a pedestrian pedestal) on a pedestal foundation no. 1 (small foundation) is now used to mount only pedestrian pushbuttons. See section 5.5.9.

Foundation no. 1 should only be used if the pushbuttons cannot be located on same support as the pedestrian indications. See section 5.4 for more information about placement of pushbuttons.

## **5.5.12 Non-Standard Design: Dual Mast Arm Poles, Strain Poles, Sign Bridge, Monotube, Luminaire Poles**

A non-standard structure is any structure that does not meet current standard drawing requirements or does not have a current standard drawing associated with it. These types of structures typically include poles for dual mast arms, steel strain poles, or diagonal structures. Note that dual mast arms are not an option when using poles that support mast arms 60 to 75 feet in length. These non-standard structures are custom designed by a structural engineer and require stamped contract plans sheets that contain the specific details for steel fabrication and foundation installation. In the case of sign bridges and monotubes, specially designed mounts for the signal equipment may also be required.

Mounting signal equipment (typically pedestrian equipment) to a stand-alone luminaire pole is discouraged because the use of a standard pedestal is usually feasible. If the use of a standard

pedestal is not feasible, a stand-alone luminaire may be used to mount signal equipment only if the luminaire is operating from the same service as the traffic signal.

Contact the traffic structures engineer and see the [ODOT Traffic Structures Design Manual](#) for more information on non-standard design.

## 5.5.13 Reusing or Altering the Loading on Existing Signal Supports

Reusing an existing traffic structure is generally not recommended for a few reasons:

- The age of the structure may make analysis difficult. It will require a lot of assumptions if the necessary information cannot be found. The assumptions must be conservative, which typically leads to the analysis indicating reuse is not an option.
- The structure may be at or near its lifespan or not in great shape.
- Reusing an older pole requires a custom designed foundation (the standard drawings do not apply). This involves more engineering cost and extended review time. An old standard drawing may be used to as a starting point for analysis and design when creating a custom foundation detail sheet, but it cannot just be referenced and used without modification. This is because the old standard drawings (and specification references within) have not been maintained and therefore most likely contain out-of-date and erroneous information which must be modified and sealed by an engineer.
- For span wire installations – moving just one pole or installing just one new pole will often require adjustments to the other poles, thus necessitating more than one new pole anyway.
- Reusing a signal pole often results in more cost due to more extensive workzone traffic control. For example, moving an existing mast arm to accommodate a wider radius will require either a temporary signal while the existing mast arm is moved to its new location (the existing signal must remain in operation) or 24-7 flagging (if a temporary signal is not used).

For more info on how to analyze existing mast arm poles and strain poles, and additional information on when it may be appropriate to reuse an existing structure, refer to the [ODOT Traffic Structures Design Manual](#).

Reusing an existing signal support is often less cost effective than installing a new signal support.

## 5.5.14 Use of Other Agency (Non-ODOT) Approved Poles

This practice is typically not allowed. Contact the traffic structures engineer for guidance and approval if use of non-ODOT poles is desired.

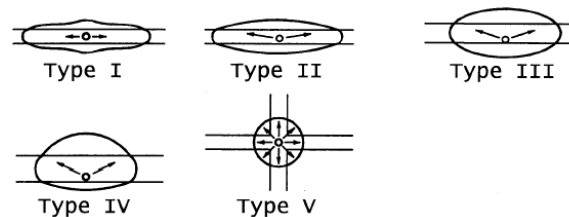
## 5.6 Illumination

Providing illumination on all traffic signal poles at an intersection is the standard. A separate stand-alone luminaire pole may be used if a mast arm pole is not located in a quadrant. If a stand-alone luminaire pole is used at the intersection, it should be powered from the same service as the traffic signal and designed according to standard drawings TM629 and TM630. The [ODOT Lighting Policy and Guidelines](#) and [Traffic Lighting Design Manual](#) contain additional information for illumination design requirements.

Standards for illumination design at signalized intersections are:

- 0-degree luminaire arm orientation (in-line with the mast arm)
- 15' arm length
- 40 feet maximum height. Contact the region electrical crew to verify the maximum height that can be reached by their equipment.
- Light emitting diode (LED) fixtures (see section 5.6.1 for more info). Contact the region electrical crew to verify the wattage of the replacement bulbs they normally stock. Note: high pressure sodium (HPS) fixtures may be used when it is necessary to match the existing illumination system.
- A type 3 light distribution pattern (see Figure 5-103)

Figure 5-103 | Illumination Engineering Society (IES) Light Distribution Patterns



Photometric analysis for signalized intersections is required to verify the default standards provide adequate illumination levels. This is typically performed by the illumination designer. A CADD file of the intersection plan view with signal pole locations is needed to perform the photometric analysis. The illumination designer will provide the following design requirements based on the photometric analysis:

- Luminaire arm orientation
- Length of luminaire arm (as per standard drawing TM629, standard lengths of luminaire arms are 6', 8', 10', 12', 15' and 20')
- Mounting height
- Type and wattage of luminaires
- If any stand-alone luminaire poles are necessary

Intersections that are big and/or complex are more likely to require deviation from the default standards. A copy of the photometric analysis should be saved in the project files (e.g., ProjectWise).

## 5.6.1 Light Emitting Diode (LED) fixtures

LED fixtures should be used on new projects or on modification projects (that are converting/changing existing fixtures). The specific LED fixtures used on the project shall be approved by the region electrical manager and/or the illumination engineer. See standard specification section 02926.54 and special provision section 00970.15 for LED fixture information. Contact the [illumination engineer](#) for any questions on use of LED fixtures.

The general guidance for LED power requirements at standard intersections of two-way, two-lane highways to comply with ODOT illumination standards is as follows:

- 250-275 watt LED (2 locations, far corners on the mainline)
- 130-140 watt LED (4 locations, at each corner of the intersection)

## 5.6.2 Photo Electric Control Relay

The photo electric control relay is a device used for turning on luminaires based on the ambient lighting conditions. It should be placed on the signal pole that is closest to the base mounted service cabinet (BMCL). The photo electric control relay should be oriented towards the north sky.

## 5.6.3 Illumination Wiring

The wiring for the illumination that is part of the traffic signal (located on the signal poles) is wired directly from the service cabinet to luminaire and photo electric control relay.

Illumination wiring shall not be routed through the signal controller cabinet.

- Three No. 12 AWG THWN wires are needed from the BMCL to the photo electric control relay.
- Two No. 10 AWG XHHW wires are needed from the BMCL to each luminaire (each luminaire must have independent wires directly from the BMCL). Daisy chaining the illumination wiring from luminaire to luminaire is no longer allowed. This wiring will be spliced to the TC cable (see bullet below) via an in-line fuse holder at the pole base.
- TC cable is used from the pole base (splice point using an in-line fuse holder) to the luminaire ballast. This wiring is NOT shown on the plan sheets but is contained in specification 00970.42.
- The ground/bond wire to the signal/illumination pole is a No. 6 AWG THWN. This wiring is NOT shown on the plan sheets but is contained in specification 00960.45(b).



## 5.7 Fire Preemption

Fire preemption should only be included at a traffic signal if the area/operators have been approved for use. Typically, if fire preemption is present at an existing intersection, it has already been approved and should be replaced if the signal is re-built. The state traffic operations engineer maintains a list of approved fire preemption areas/operators. The signal designer should contact the state traffic operations engineer to verify the approval is documented. If the project scope does not mention fire preemption, verify that fire preemption is not needed or wanted with region traffic. Region traffic will then work with the local operators in the area and submit a request for operation approval to the STRE if needed.

If fire preemption used, the detector must be located with a clear line of sight for a minimum distance of 1500 feet. Preferred placement of the detector is on the near side of a mast arm. Remote detectors, multiple barrel devices or alternate locations will be necessary if the roadway curves prior to entering the intersection.

One specialty cable for the fire preemption system is needed from the device mounted in the field back to the signal controller cabinet. No splices are allowed.

All pre-approved (see the green sheets) fire preemption equipment can provide encryption (to assign IDs to those that use the system). However, ODOT does not currently have any jurisdictions using this feature.

## 5.8 Power Source

Commercial power is used to power all electrical installations (except where solar power has been allowed as an option: e.g., flashing beacons, RRFB, etc.). When installing a new traffic signal, the nearest location to draw power from (the power source) should be used. Power can only be tapped off of a transformer. The Figure 5-104 shows a typical example of a transformer.

Figure 5-104 | Transformer Example



It is critical to work with the region utility specialist to determine what type of power is available and the location of the power source. The traffic signal service requires commercial power of 120V (or 120V/240V if illumination will be provided on the traffic signal). If the existing power source is unacceptable or needs modifications to work, the region utility specialist will handle these issues.

Sometimes the project will necessitate moving the existing power source location to a new location. If this is the case, the signal plan sheets will need to show this.

The wiring from the power source shall enter the service cabinet via a conduit (no aerial connections, except for temporary signals). The design of the conduit and wiring from the power source to the service cabinet is per the requirements of the power company. The plan sheet should just show a reference to the conduit and wiring indicating this. The contractor is responsible for installing the conduit and pull line from the service cabinet to the power source, and the power company is responsible for installing and terminating the wiring from the service cabinet to the power source.

## 5.9 Battery Back-Up

A battery back-up system can provide emergency power to a traffic signal in the event of a power outage or interruption of a minor duration. Some intersections, due to their location, and operational/geometric characteristics, may experience congestion or be intimidating to drive through in the event of a power outage. However, a dark signal treated as an all-way stop is a safe, albeit inefficient and sometimes frustrating, mode of operation in the interim. Battery back-up may be beneficial to ease congestion/queuing in the following situations where there is a history of frequent power outages of a duration between 15 minutes to 2 hours:

- Isolated location (long travel times for region electrical crew to get to the signal)
- High volume intersections (ADT >20,000 on the mainline)
- Unusual geometry (e.g., single point urban diamonds, more than 4 approach legs, etc.)
- Six or more travel lanes per road
- Railroad interconnection

Battery back-up does have some drawbacks (based on field experience) that should be considered before making the decision to install it:

- It requires more labor/time resources. A significant amount of maintenance and monitoring is needed to ensure that it will be ready to perform when needed.
- It will not work well for extended power outages. Alternate solutions such as flagging, installing STOP signs, or an external generator will likely be necessary.
- If the signal with battery back-up is located in a coordinated corridor with other traffic signals that don't have battery back-up, congestion/queuing will not improve that much when the power outage affects the entire corridor.
- The transfer of power from commercial power to the battery back-up is not always seamless and may cause the signal to go into flash mode which has to be manually reset.

The decision to install battery back-up is made at the district level in conjunction with input from the region traffic engineer.

If battery back-up is deemed necessary, the following standard applies:

- The operating electrical load of the intersection shall be calculated to confirm the battery back-up equipment meets the current specifications (see the ODOT Standard Specification for Microcomputer Signal Controller and the approved products listed in the green sheets). Adjustment for a higher capacity battery back-up system to accommodate larger operating loads will be made on an as needed basis.

## 5.10 Controller Cabinets

### 5.10.1 Location

If possible, locate the controller on the right side of a side street approach and try to obtain a power source in that quadrant. There may be limitations that preclude this location such as R/W, power source locations, sidewalk, or businesses located in the quadrant. Contact the region electrical crew for their preference on the location of the controller cabinet.

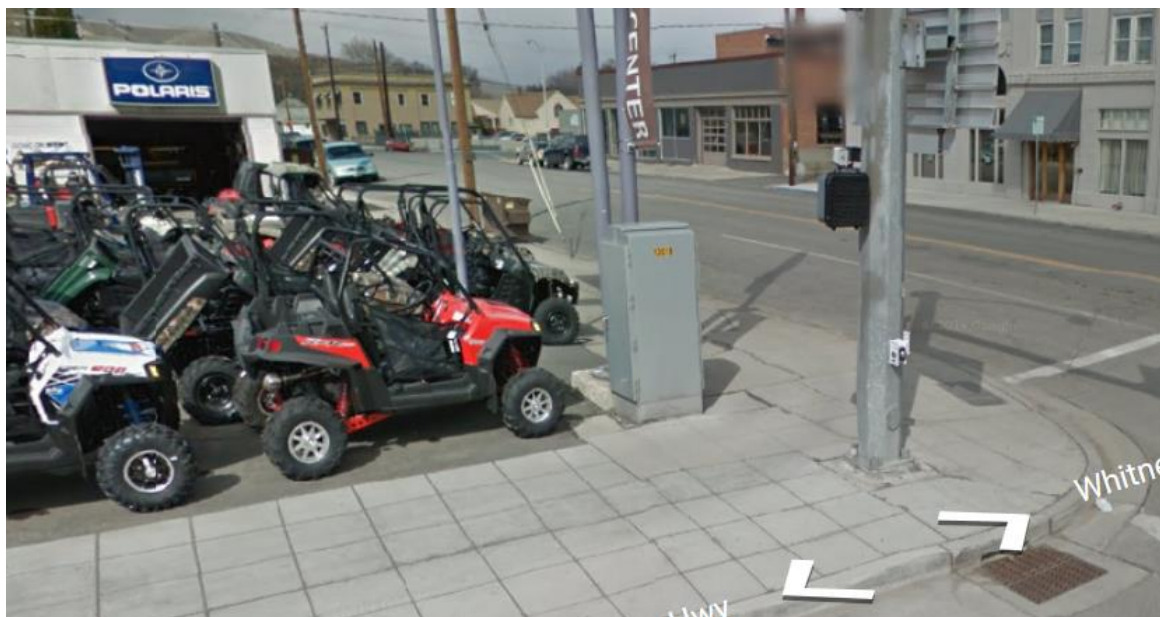
The controller cabinet and the service cabinet should be located together in the same quadrant for ease of maintenance, spaced a minimum of 10 feet apart.

Locate the controller cabinet so that it does not obstruct the view for a side street vehicle turning right-on-red. The controller cabinet has a front louvered door that swings open to the left and a back solid door that swings open to the right. Orient the controller cabinet:

- To have the cabinet doors swing away from traffic, and
- To have the louvered front door positioned to allow a view of a minimum of two traffic signal phases for a person standing in front of and facing the louvered front door (for when electricians or region traffic signal timers are working in the cabinet).

The right-of-way, adjacent properties, and the pedestrian clear circulation path may also have influence on the location and orientation of the controller cabinet. Figure 5-105 shows an example of controller cabinet that is difficult to open and maintain. Make sure that the cabinet door can fully open and does not encroach on private property when fully open. Also maintain the pedestrian clear circulation path (5' minimum) when the door is open if possible.

Figure 5-105 | Controller Cabinet Front Louvered Door Encroaching on Private Property



The controller cabinet is also required to have a minimum of 3 feet working space all around it to meet applicable codes (NEC, OSHA, and NFPA) for worker safety. This needs to be verified on retro-fit projects. Figure 5-106 shows an example of curb ramp and pedestal retro-fit proposal where the 3 foot minimum working space cannot be met and will require additional design iterations to satisfy this requirement. It is also good practice to verify other project features (such as signing, barriers, etc.) for permanent or temporary installation also meet the 3 foot minimum from the cabinet. See Figure 5-107 for example where a temporary sign blocked access to the controller cabinet.

Figure 5-106 | Controller Cabinet Without the 3 Foot Minimum Working Space

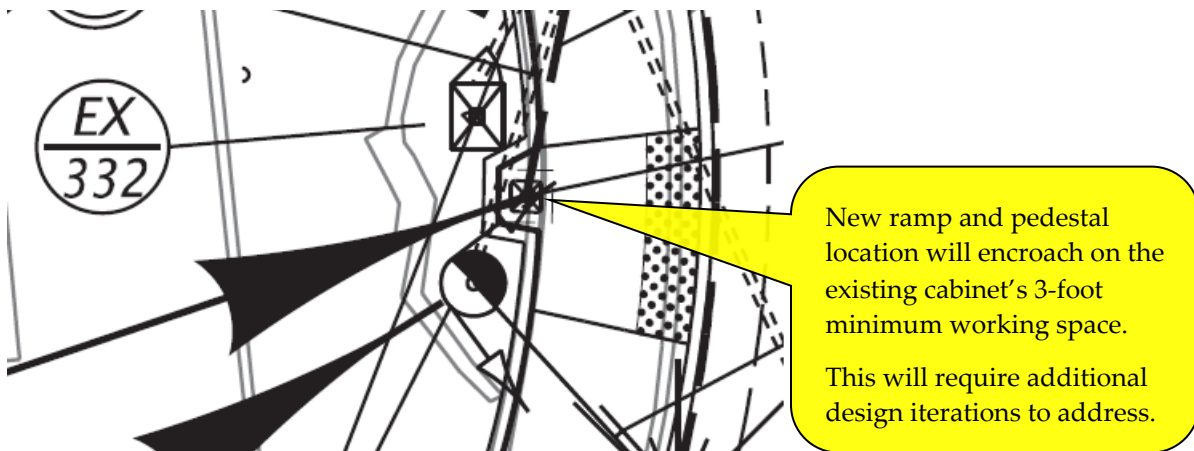
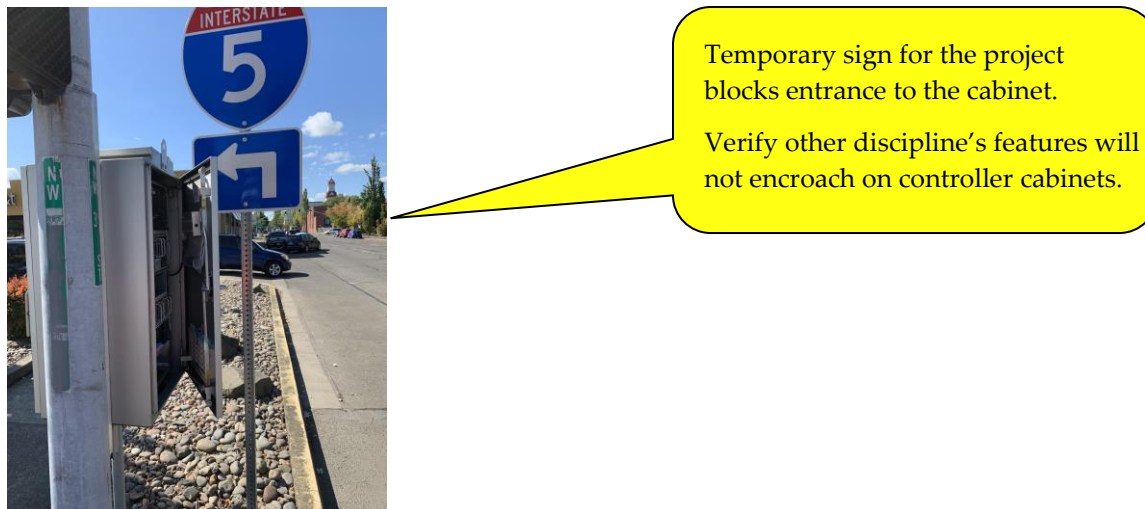


Figure 5-107 | Controller Cabinet Without the 3 Foot Minimum Working Space Due to Other Features Installed on the Project



As per standard drawing TM482, the controller cabinet will have landing pads at the front and back of the cabinet. If there is sidewalk where the controller cabinet is located, it will be placed flush to the back of the sidewalk. If sidewalk is not present where the controller cabinet is

located, a 3-foot-wide concrete walkway for the controller cabinet (and service cabinet) is required. Coordinate with the roadway designer for showing and detailing this concrete walkway on the plan sheets. The landing pads and the walkway are important features that improve the maintainability (and thus service life) of the traffic signal.

## 5.10.2 332S Controller Cabinet

The 332S controller cabinet is a ground mounted cabinet which is the standard for both permanent and temporary traffic signals. It provides more room and options than the old 332 cabinet.

## 5.10.3 332 Controller Cabinet

The 332 controller cabinet is a ground mounted cabinet. It is no longer used in new construction.

## 5.10.4 336 and 336S Controller Cabinet

The 336 and 336S controller cabinets are pole mounted cabinets, smaller than the 332 cabinet. These cabinets are no longer used for permanent or temporary signals.

In the past, these cabinets were commonly used in downtown corridors where the traffic signals operation is simple and pre-timed. However, there are a few reasons why the pole mounted cabinet is no longer used for a permanent or temporary installation:

- They have limited space inside and still take up the same amount of room (width and depth) as a standard 332S cabinet. The only room that is saved is directly underneath the cabinet, which isn't useable.
- They produce challenges for meeting ADA requirements since it creates a protruding object unless it is placed away from a pedestrian walkway.
- A temporary pre-cast foundation that is easy to install and remove for temporary staging is now standard.

## 5.10.5 Controller Cabinet Power

The controller cabinet is wired to the service cabinet with two No. 6 AWG XHHW wires (shown on the plan sheets) and a ground wire (NOT shown on the plan sheets).

## 5.10.6 ATC Controller

ODOT has a price agreement contract for the ATC controller which is administered by the ITS unit. Using the price agreement contract on a project will depend on who owns/maintains the signal AND who issues the construction contract. The plan sheets will need to use the correct language in the ATC controller installation bubble note legend as described below and shown in Figure 5-108.

- **On ODOT construction contracts:** For signals ODOT owns (regardless of who maintains) and for local agency owned signals that ODOT maintains, the bubble note legend text shall state the ATC controller is “Agency Furnished”. TSSU will provide the ATC controller via the price agreement contract and will charge the contract. The contractor is not responsible for providing the ATC controller or any costs associated with it.
- **On local agency construction contracts:** For any signal, regardless of if it owned or maintained by ODOT, the bubble note legend text shall show the ATC controller is provided by the contractor. The reason being it is difficult for ODOT to recover the cost of providing the ATC controller via the price agreement contract on a construction contract ODOT didn’t issue. The contractor is responsible for providing the ATC controller and costs associated with it. In very rare cases, the local agency administering the contract may elect to furnish the ATC controller (note: they are unable to purchase via the ODOT price agreement contract) and would then use the “Agency Furnished” language in the bubble note legend text.
- **On developer projects by permit:** For any signal, regardless of if it owned or maintained by ODOT, the bubble note legend text shall show the ATC controller is provided by the contractor. The reason being there isn’t a way for ODOT to recover the cost of providing the ATC controller via the price agreement contract. The contractor is responsible for providing the ATC controller and costs associated with it.
- **Local agency owned and maintained signals:** For any local agency owned and maintained signals, regardless of who issues the contract, the bubble note legend text shall show the ATC controller is provided by the contractor. The reason being the price agreement contract is not available to local agencies for local agency owned and maintained signals. ODOT also cannot purchase ATC controllers from the price agreement contract on behalf of the local agency for local agency owned and maintained signals. The contractor is responsible for providing the ATC controller and costs associated with it.

In the rare case where a project requires use of both agency furnished and contractor furnished ATC controllers, contact the state traffic signal engineer for guidance on using custom notes.

Figure 5-108 | ATC Controller Installation Bubble Note Based on Project Specifics



*Install model ATC controller. (Agency furnished)*

Use this bubble note for any ODOT construction contracts at signals that are owned or maintained by ODOT.



*Install model ATC controller*

Absence of the “agency furnished” language shows the contractor is responsible for providing the ATC controller. Use this bubble note for any:

- Local agency construction contracts
- Developer projects by permit
- Signals that are local agency owned and maintained



## **5.11 Service Cabinets**

### **5.11.1 Base Mounted Service Cabinet (BMC)**

A base mounted service cabinet (BMC) shown in standard drawing TM485 is the standard service type for traffic signal installations. The BMC should be located in the same quadrant as the controller cabinet. This makes the BMC convenient for maintenance personnel working on the signal. The BMC is required to have a minimum of 3 feet working space all around it to meet applicable codes (NEC, OSHA, and NFPA) for worker safety but the ODOT standard is to locate the BMC at least 10 feet away from any other equipment (e.g., controller, poles, etc.). The BMC should be located on the right side of a side street approach to mitigate mainline exposure and to avoid obstructing the view of side street vehicles making a right turn on red.

### **5.11.2 Base Mounted Service Cabinet with illumination (BMCL)**

Section 5.11.1 still applies; except a base mounted service cabinet with illumination contains extra circuit breakers and a contactor to run a separate circuit for illumination that is part of the traffic signal.

### **5.11.3 Base Mounted Service Cabinet, Flashing Beacons (BMCF, and BMCFL)**

Section 5.11.1 still applies; except a base mounted service cabinet for flashing beacons contains contacts for the flashing indications. The BMCFL can accommodate illumination that is part of the flashing beacon. See chapter 12 for more info on flashing beacons.

### **5.11.4 Pole Mounted Service Cabinet (SC) and Meter Base (MC)**

This type of service is only allowed for temporary signals. See chapter 11 for more information on temporary signals.

### **5.11.5 Remote Post Mounted Service (RPS)**

This style of service is no longer used for new construction.

### **5.11.6 Wiring**

The wiring from the power source to the service cabinet is per the requirements of the power company. See section 5.8 for more information.

The wiring from the service cabinet to the controller cabinet is two No. 6 AWG XHHW wires.

## 5.12 Junction Boxes

Junction boxes provide a pull point for wires/cables coming from the controller cabinet to the various pieces of equipment in the field. Guidelines for general use are shown on standard drawing TM472.

### 5.12.1 Junction Box Type and Size

The junction box type/size is determined by the total conduit diameter that is contained within the junction box and the location of where the junction box is located. There are three available sizes as per standard drawing TM472 (JB-1 = small, JB-2 = medium, and JB-3 = large). However, there is default minimum type/size standard. Table 5-5 shows the default minimum standard and Table 5-6 shows how to determine if the default minimum size is adequate or not.

The type of surface that a junction box will be installed in is also an important consideration. This determines whether a concrete apron around the junction box is needed or not. Junction boxes located in the sidewalk do not require a concrete apron. Junction boxes located in unsurfaced areas (e.g., gravel shoulders, behind guard rail, in landscaped areas, etc.) require a 12-inch-wide concrete apron surrounding the box. The concrete apron provides support to the sides of the box. The ‘A’ in the junction box designation (e.g., JB-2A) indicates an apron.

Table 5-5 | Default Minimum Junction Box Type/Size

Type/Size	Location/use
JB-3T: Two (Tandem) 30"x17"x12" boxes	The same quadrant as the signal controller: first access point for all signal, detector, and interconnect wires/cables.
JB-2: Single 22"x12"x12" box	All quadrants without the signal controller: secondary access point for signal, detector, and/or interconnect wires/cables.

Table 5-6 | Sizing for Junction Box Type/Size

Type	Size	Total Conduit Diameters Allowed (Inches)	Remarks	Material
JB-1 & JB-1A	17"x10"x12"	12	Non-traffic areas only	Concrete/Concrete Polymer
JB-2 & JB-2A	22"x12"x12"	18		
JB-3 & JB-3A	30"x17"x12"	34		

### 5.12.2 Junction Box Placement

Junction boxes should be spaced a maximum of 300 feet between junction boxes on a conduit run. Note that handholes used for ITS applications (fiber communication) may be spaced a maximum of 1000 feet as per TM472.

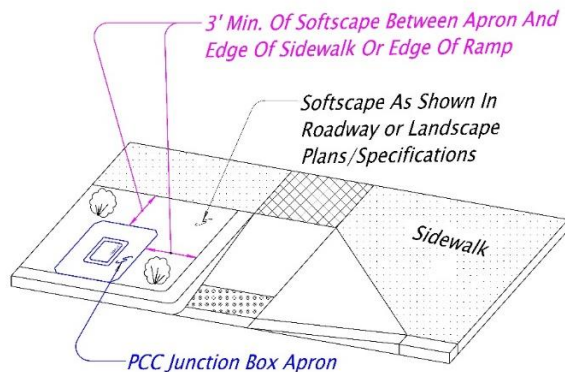
Junction boxes should be located within 50 feet of the nearest signal pole, pedestal, or controller cabinet.

Junction boxes may be located in the sidewalk, raised islands, or in unsurfaced areas with incidental traffic (e.g., gravel shoulders, behind guard rail, in landscaped areas, etc.). The junction box should be placed in a flat area that can be easily and safely accessed by region electrical crews.

Consideration should be given to water flow and drainage to avoid placing a box in a low spot that will collect a significant amount of water.

When boxes are located in unsurfaced areas near sidewalk or curb ramps, care needs to be taken to ensure that the appropriate ADA requirements for softscaping (rock, bark, grass, etc.) are met. A minimum of 3 feet from the edge of the PCC junction box apron to the edge of the sidewalk or curb is required. See Figure 5-109. The intent of the softscaping is to provide tactile information to a visually impaired pedestrian about the path they should or should not follow. Concrete aprons for junction boxes located too closely to a curb, curb ramp, or sidewalk are hard to distinguish from the concrete of the sidewalk/curb ramp and could mislead a visually impaired pedestrian off the appropriate path. If the 3-foot minimum cannot be obtained or there are site-specific questions about the need for softscaping, it is best to work with the roadway designer and traffic-roadway section early to determine the best solution (which may require an ADA curb ramp design exception or other mitigation).

Figure 5-109 | ADA Softscaping Requirements for Junction Box PCC Apron



Do not place a junction box in the following areas:

- Within a travel lane
- Driveway or access where it may be exposed to traffic
- In the slope or landing area of a curb ramp

If it is important to have the junction box at very specific location, make sure to note that on the plans with appropriate detail (station/offset/elevation) otherwise, standard drawing TM472 allows the contractor some flexibility to place junction boxes at the approximate location shown.

### **5.12.3 Use of Existing Junction Boxes**

Use of existing junction boxes is allowed if all of the following statements are true:

- The junction box is relatively new, in good condition, and in a good location,
- The junction box is the appropriate size,
- The junction box itself will not have to be adjusted due to the adjacent construction work, and
- The junction box will not have any new conduit installed within.

Junction boxes are a very low-cost item and it is more cost effective to remove an old junction box and install a new one if any of the above statements are false. A common construction change order on preservation projects is additional payment for the contractor to adjust or install new junction boxes as a result of the work done on the roadway shoulder. Change orders should be avoided as they are generally more expensive than having the contractor bid the same work. Therefore, if there is a good chance that an existing junction box will be damaged, need adjustment, or is just a maintenance headache, you should remove it and install a new one. If, during construction, the contractor is able to use the existing junction box they can submit a cost reduction proposal (as per specification 00140.70) that can be considered (which should result in a credit to the contract if the existing boxes can indeed be used).

## 5.12.4 Elevation Adjustments & Considerations for Existing Junction Boxes

Retro-fit projects often change the existing finish grade elevations which requires attention to how existing junction boxes (and the conduit and wiring inside) will be impacted. The standard junction box depth is 12 inches (see TM472) with conduit exposed 2 to 3 inches above of the bottom of the junction box (see TM471). See Figure 5-110 and Figure 5-111 for examples of the impacts resulting from elevation changes.

Figure 5-110 | Impacts from Lowering Elevation Without Adjusting Conduit in Junction Box

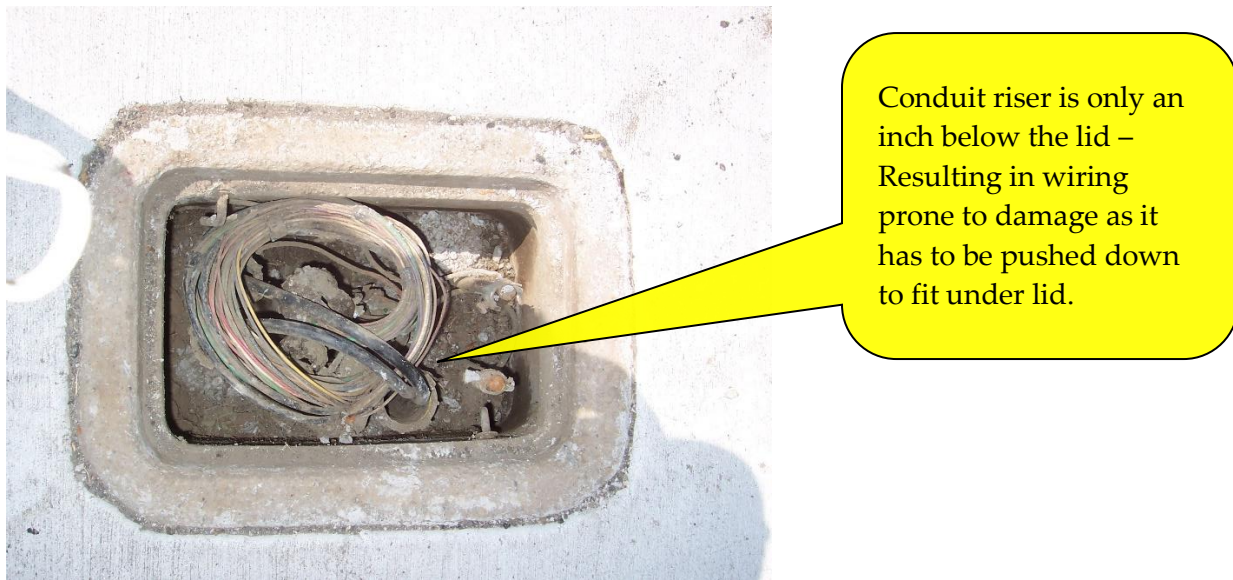


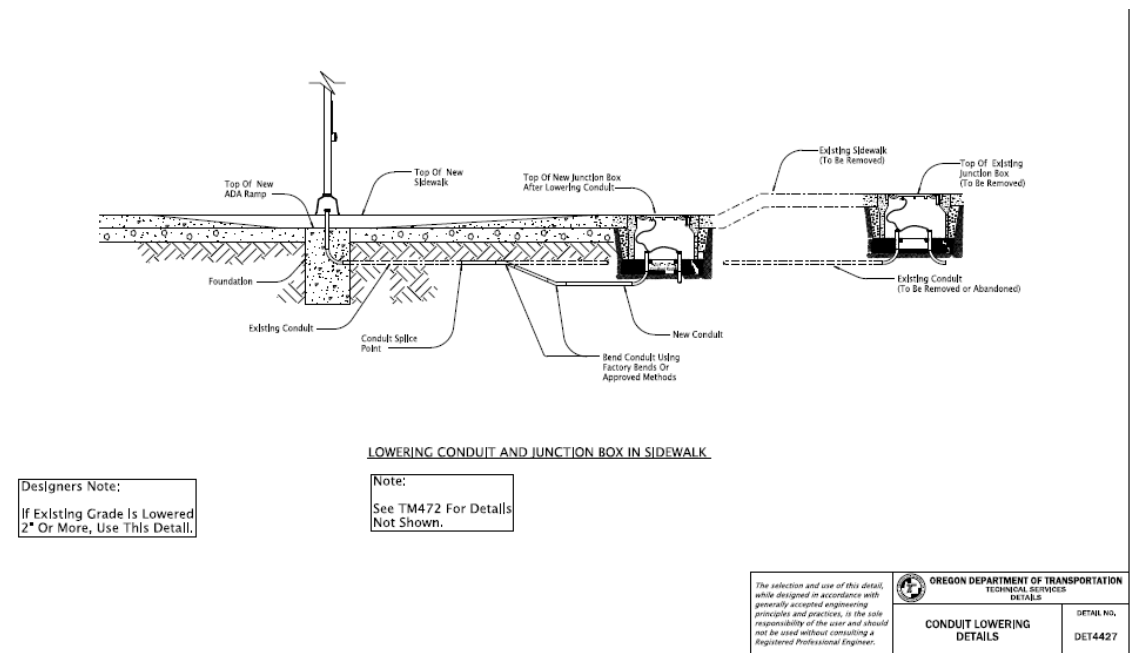
Figure 5-111 | Impacts from Raising Elevation Without Adjusting Junction Box



If the finish grade elevation increases, the junction box will need to be raised so that it is flush to the new surface. This requires the foundation of the junction box to be raised which is likely to require the conduit risers to also be replaced to maintain proper clearance above the bottom of the box and to allow good compaction of the crushed rock foundation. Replacing the conduit risers then requires removing the existing wiring to the nearest junction box while the conduit riser is replaced and then re-installing the existing wiring into the new conduit riser. See note below in yellow box for more additional info about re-installing existing wiring.

If the finish grade elevation decreases, the junction box will need to be lowered so that it is flush to the new surface. If the existing junction box elevation changes more than an inch, use DET4427 which shows how to adjust the conduit elevation in the lowered junction box. See Figure 5-112. This detail requires removing the existing wiring to the nearest junction box while the conduit is adjusted and then re-installing existing wiring into the new lowered conduit. Note that replacing an existing junction box with a handhole (without finish grade elevation changes) will also require using this conduit lowering detail due the additional 12 to 24 inches of box depth.

Figure 5-112 | DET4427 – Conduit Lowering Details



Conduits are not allowed to enter the side of standard traffic signal junction boxes, they must enter from the bottom of the box as per TM471.

**If adjustment of any existing junction boxes will require replacing/splicing existing conduit (which requires re-installing wiring), verify with region electrical crew if the existing wiring can be re-installed or if all new wire should be installed. If the traffic signal condition rating is low or the signal is over 20 years old, re-installing existing wire is not recommended.**

## 5.12.5 Deviations From Junction Box Placement Standards

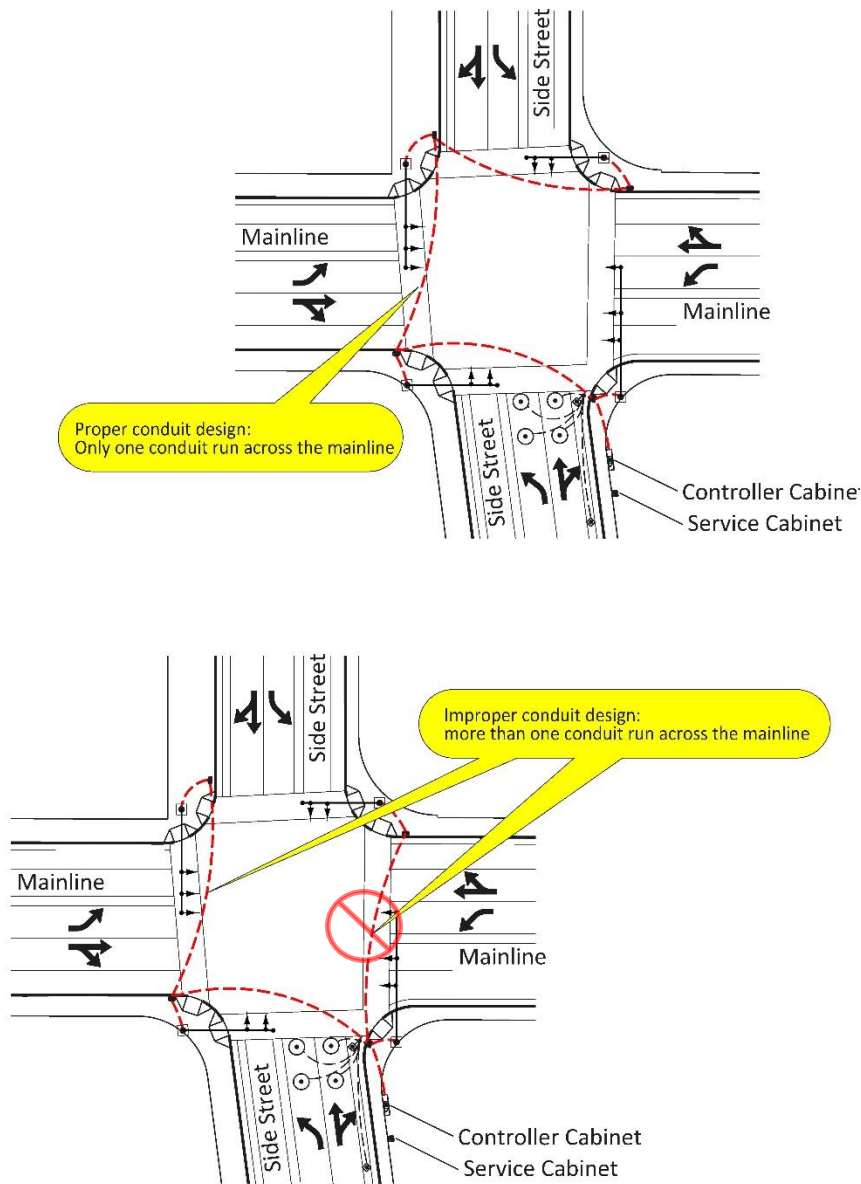
Meeting all of the criteria listed in section 5.12 may be impossible at certain locations where the project scope and budget is very limited (e.g., curb ramp replacement projects, ARTS projects, etc.). If unable to meet any of the criteria in section 5.12, deviations may be considered. The most common deviations are listed below. Any deviations require approval of the state traffic signal engineer during the design approval process.

- **Junction box placement in the slope or landing area of a curb ramp.** When curb ramps are redesigned the existing junction boxes often end up being located in the slope or landing area of the new curb ramp. When possible, the preferred solution is to relocate the junction box to new location as per the placement standards in section 5.12.2 by splicing new conduit to the existing conduit. However, depending on the age of the traffic signal system and project scope, splicing the existing conduit system to relocate the junction box might be too risky. In these cases, replacing the junction box in-place might be the best solution. The junction box has to be installed flush, so it cannot span two different plans. If the junction box is installed on a slope, additional support of the box with a modified concrete apron and foundation is likely necessary to ensure the box remains flush to the sloped surface over time. Custom details with appropriate information (station/offset/elevation) should be shown in the plans.
- **Using a non-standard junction box depth or a modified foundation for the junction box.** If the finish grade elevation changes require raising an existing junction box, installing a deeper than standard depth junction box, handhole, or modifying the junction box foundation (e.g., extra concrete at the edge of the new box to raise it up) may be appropriate solutions depending on the project scope and age of the traffic signal system (to avoid risky conduit and re-wiring work). Custom details with appropriate information (station/offset/elevation) should be shown in the plans.

### 5.13 Conduit

Once the junction box placement is complete, conduits routes can be determined to connect all equipment to the controller cabinet. Standard practice is to cross the mainline only one time. See Figure 5-113. Conduit that goes across an existing roadway (mainline or side-street) should be installed by horizontally directional drilling (HDD) to avoid the temporary traffic control and potential pavement damage associated with open trenching.

Figure 5-113 | General Conduit Layout





## 5.13.1 Conduit Size

To determine the proper size of conduit, two criteria need to be considered: ODOT requirements and the wire fill calculation. The larger of the two criteria governs. See section 5.14 for information on wiring.

ODOT Requirements:

- Conduit crossing mainline or side street shall be 2-inch diameter minimum
- One spare 2-inch diameter conduit from the controller cabinet to the nearest junction box shall be installed for future use, shall contain a poly pull line and be capped at each end
- 1½-inch diameter minimum size conduit
- 3-inch diameter maximum size conduit
- If loop detection is approved by the state traffic signal engineer on the project as per chapter 6, one spare 2-inch diameter conduit from the signal pole to the nearest junction box shall be installed for future installation of non-invasive detection. The spare conduit shall contain a poly pull line and be capped at each end. This spare conduit shall be omitted when non-invasive detection (the default standard) is installed.

Regions may have a minimum value that is larger than the statewide minimum standards listed above. Verify with region traffic or region electrical crews. Additional spare conduits may also be installed if anticipated future conditions deem them necessary. Larger conduit and spare conduits can be helpful in the future when a traffic signal requires a retro-fit to meet the ever changing design standards and technology requirements. However, increasing conduit size and/or adding additional spare conduits can come with some downsides that should be considered:

- Larger junction boxes and/or deeper conduit trenches may be required.
- Conduit larger than 2-inches and/or more than 4 conduits installed in a mast arm pole foundation greatly increases the difficulty in installing them properly around the rebar/anchor rods. Verification of clearances to the foundation rebar/anchor rods is necessary and custom installation details may be required on the plan sheets.
- Conduit installed for future purposes is very risky unless the future project has well defined design parameters and dedicated funding. There have been projects in the past where future design and/or funding were not pinned down which resulted in either the spare conduits not being installed in the right location for the future design (and couldn't be used) or the age of spare conduits had resulted in enough deterioration that they were no longer usable on a future project.

The ODOT minimum design standard for new construction allows a maximum wire fill of 70 percent of the NEC maximum allowed wire fill. This allows ample room for additional wires if needed in the future. For existing signals where new wire is being installed into existing conduit, the NEC maximum allowed wire fill is acceptable to use. To calculate wire fill, use Table 5-7 through Table 5-9. See Figure 5-114 and Figure 5-115 for example calculations.

Table 5-7 | Wire Area

Cable AWG	Cable Area (in <sup>2</sup> )		Cable Type	Cable Area (in <sup>2</sup> )
	THWN	XHHW		
18	n/a	n/a	FPC	0.0784
16	n/a	n/a	LF	0.0908
14	0.0097	0.0139	LF 18awg	0.0616
12	0.0133	0.0181	6/P	0.3117
10	0.0211	0.0243	12/P	0.4902
8	0.0366	0.0437	CC 4/14	0.1257
6	0.0507	0.0590	CC 5/14	0.1452
4	0.0824	0.0814	CC 6/14	0.1698
3	0.0973	0.0962	CC 7/14	0.1735
2	0.1158	0.1146	CC 10/14	0.2922
1	0.1562	0.1399	CC 12/14	0.3117
1/0	0.1855	0.1825	CC 15/14	0.3632
2/0	0.2223	0.2190	Video Cable	0.2866
3/0	0.2679	0.2642	Radar Cable	0.1320
4/0	0.3237	0.3197	Cat 6 Cable	0.0881
			Fiber Optics	Variable: contact ITS for correct size
			Piezo Cable (ATR)	0.187

Table 5-8 | Conduit Fill Table (NEC & ODOT Max Fill: PVC Schedule 40 and HDPE Conduit, Article 344 in NEC Chapter 9, table 4)

Conduit size Inch	Internal Dia Inch	NEC % Max Fill (in <sup>2</sup> )			ODOT % Max Fill (in <sup>2</sup> )		
		1 wire 53%	2 wires 31%	3+ wires 40%	1 wire 53%	2 wires 31%	3+ wires 40%
1/2	0.602	0.151	0.088	0.114	0.106	0.062	0.080
3/4	0.804	0.269	0.157	0.203	0.188	0.110	0.142
1	1.029	0.441	0.258	0.333	0.309	0.180	0.233
1 1/4	1.360	0.77	0.45	0.581	0.539	0.315	0.407
1 1/2	1.590	1.052	0.616	0.794	0.737	0.431	0.556
2	2.047	1.744	1.02	1.316	1.221	0.714	0.921
2 1/2	2.445	2.488	1.455	1.878	1.742	1.019	1.315
3	3.042	3.852	2.253	2.907	2.696	1.577	2.035
3 1/2	3.521	5.161	3.018	3.895	3.612	2.113	2.726
4	3.998	6.654	3.892	5.022	4.657	2.724	3.515

Table 5-9 | Wire Fill Requirements

<b>Wire Fill Requirements</b>	
Existing conduit:	Sum of Cable Area (in <sup>2</sup> ) within conduit < NEC % Max Fill (in <sup>2</sup> )
New conduit:	Sum of Cable Area (in <sup>2</sup> ) within conduit < ODOT % Max Fill (in <sup>2</sup> )

Figure 5-114 | Conduit Sizing Example 1

### Conduit Sizing Example No. 1

**Given:** How large of a new conduit is needed if the conduit has to carry the following cables?  
 1.) Thirteen No. 14 AWG THWN                      4.) One No. 8 AWG THWN (signal system common)  
 2.) Two Loop Feeder Cables\*                      5.) One No. 6 AWG THWN (Ground/Bond wire. Not shown on plans, but required by specification)  
 3.) One 6/P (interconnect cable)\*

**Step 1:** Determine Total cable area using Cable Area Chart:

13*(0.0097) = 0.1261	1*(0.0366)= 0.0366	*Note - loop feeder cables and interconnect cable are normally installed in separate conduits from the signal system.
2*(0.0908) = 0.1816	1*(0.0507)= 0.0507	
1*(0.3117) = 0.3117		

Total Sum = (0.1261+0.1816+0.3117+0.0366+0.0507) = **0.7067**

**Step 2:** Use the ODOT % Max Fill Chart to compare calculated total sum to max. allowable fill (use column for 3+ wires - since the total # of wires in this conduit is 18)

0.7067 > 0.556, therefore, a 1.5" conduit is too small

0.7067 < 0.921 , therefore a 2" conduit is OK\*\*

\*\*check to make sure that a 2" conduit will meet the other ODOT requirements for conduit size

Figure 5-115 | Conduit Sizing Example 2

### Conduit Sizing Example No. 2

**Given:** An existing 2" conduit has the following existing cables, can 4 additional Loop Feeder cables be installed?  
 1.) Thirteen AWG No. 14 THWN                      4.) One No. 8 AWG THWN (signal system common)  
 2.) Two Loop Feeder Cables\*                      5.) One No. 6 AWG THWN (Ground/Bond wire. Not shown on plans, but required by specification)  
 3.) One 6/P (interconnect cable)\*

**Step 1:** Determine Total cable area using Cable Area Chart:

13*(0.0097) = 0.1261	1*(0.0366)= 0.0366	*Note - loop feeder cables and interconnect cable are normally installed in separate conduits from the signal system.
2*(0.0908) = 0.1816	1*(0.0507)= 0.0507	
1*(0.3117) = 0.3117		
4*(0.0908) = 0.3632    } New Cables		

Total Sum =(0.1261+0.1816+0.3117+0.3632+0.0366+0.0507+0.3632) =1.0699

**Step 2:** Use the NEC % Max Fill Chart to compare calculated total sum to max. allowable fill (use column for 3+ wires - since the total # of wires in this conduit is 22)





1.0699 < 1.316 , therefore the existing 2" conduit is big enough to allow the new cables\*\*

\*\* note that for a new conduit installation, a 2.5" conduit would be required based on ODOT's Max Fill Chart

Wire fill rates can be visually deceiving if you are not accustomed to working with conduit and wire. Table 5-10 should be helpful in providing some perspective (note: the conduit bushing has not been installed for better photo clarity).

For new wire installations in existing conduit, the signal designer **MUST** check the existing conduit size and wire count in the field to make sure the proposed new wires will not exceed the NEC maximum allowed wire fill. Failure to check this is a fatal flaw.

Table 5-10 | Visual Wire Fill Requirements

 <p>1" conduit w/5 loop feeder cables Exceeds NEC max fill Exceeds ODOT max fill</p>	 <p>1" conduit w/4 loop feeder cables Exceeds NEC max fill Exceeds ODOT max fill</p>
 <p>1" conduit w/3 loop feeder cables Does NOT exceed NEC max fill Exceeds ODOT max fill</p>	 <p>1" conduit w/2 loop feeder cables Does NOT exceed NEC max fill Exceeds ODOT max fill (just barely)</p>



1 1/2" conduit w/control cables  
Does NOT exceed NEC max fill  
Exceeds ODOT max fill



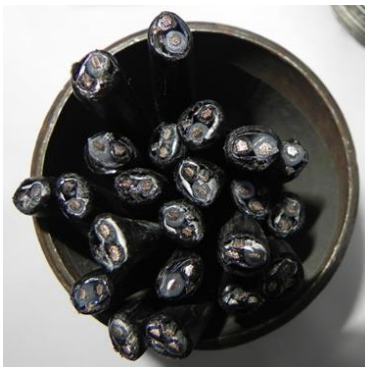
2" conduit w/control cables  
Does NOT exceed NEC max fill  
Does NOT exceed ODOT max fill



1 1/2" conduit w/9 loop feeder cables  
Exceeds NEC max fill  
Exceeds ODOT max fill



1 1/2" conduit w/9 loop feeder cables + 1 video cable  
Exceeds NEC max fill  
Exceeds ODOT max fill



2 1/2" conduit w/22 loop feeder cables  
Exceeds NEC max fill  
Exceeds ODOT max fill



3" conduit w/22 loop feeder cables  
Does NOT exceed NEC max fill  
Does NOT exceed ODOT max fill

## 5.13.2 Conduit Materials

There are several different types of conduit materials that can be used for traffic signal installations. The conduit material is NOT specified on the plan sheets as this information is contained within the standard drawing TM471 (contractor shall install non-metallic conduit unless otherwise shown). The following information is some basics on conduit materials. Refer to standard drawing TM471 for detailed info.

- **Rigid Metallic Conduit**
  - Typically not used for permanent traffic signals. Rigid galvanized metallic conduit is a good choice where there is the potential for damage, such as conduit located above ground (on poles or structures). However, fiberglass is also a good choice for conduit installed on structures and should be considered first.
  - For conduit located under railroad tracks, there is a requirement to place the conduit holding wires within a rigid metallic conduit “sleeve” as per the special provision boiler plates.
- **Rigid Non-Metallic Conduit**
  - Fiberglass (schedule 40) – used for elbows and in foundations as per standard drawing TM471. Fiberglass can also be used instead of rigid metallic conduit in above ground locations.
  - PVC (schedule 40) – used for risers in junction boxes as per standard drawing TM471. This is the most common type of rigid non-metallic conduit used for other applications in traffic signal installations due to cost and availability.
  - High density polyethylene (HDPE) – typically used when installing conduit by horizontal directional drilling.
  - Liquid Tight Flexible – Only used for mounting conduit on temporary wood poles as per the standard drawings.

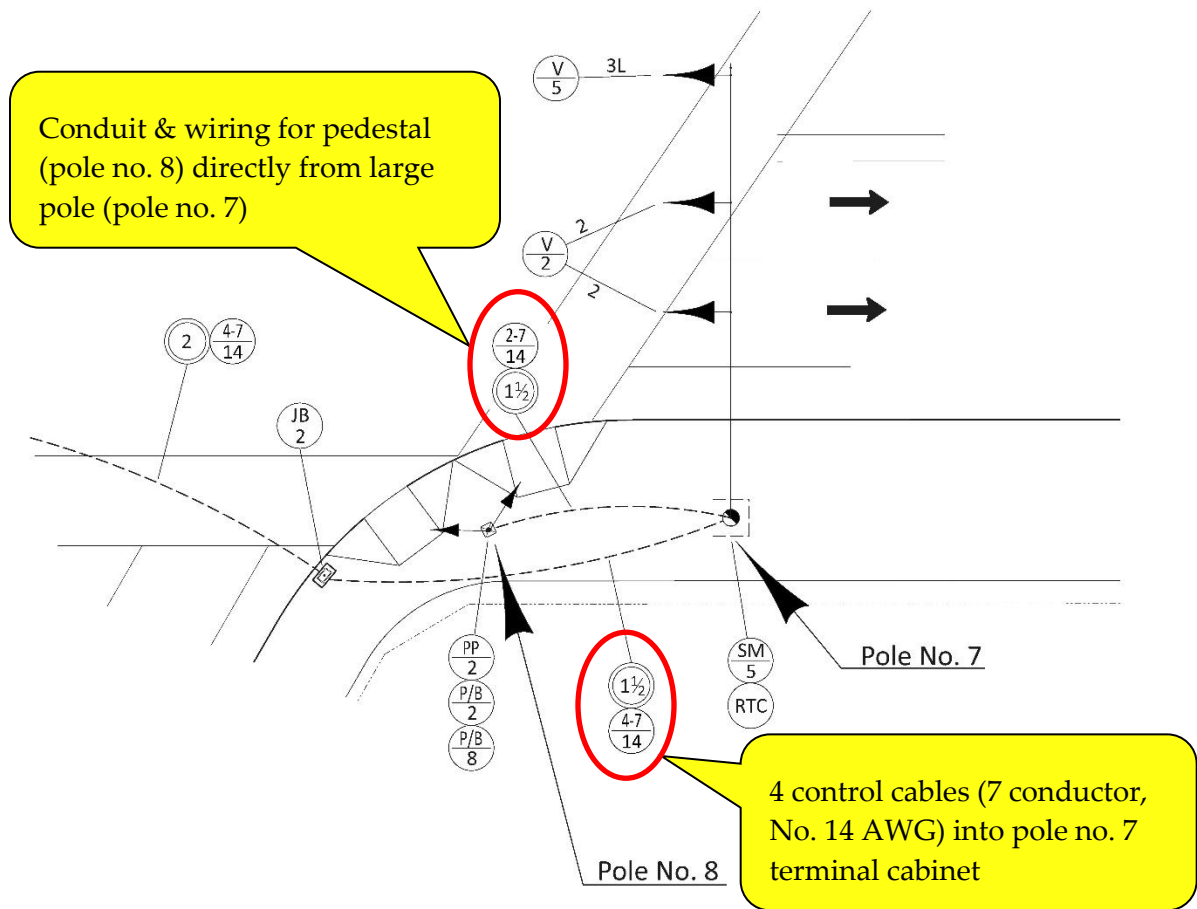
## 5.13.3 Expansion Fittings

Whenever traffic signal conduit must be placed on or in a structure, conduit expansion fittings are required. The structure will experience expansion/contraction depending on the stresses subjected to it, and so the conduit must also allow for movement too. Therefore, expansion fittings are used on the conduit run at all structure expansion joints as per the special provision boiler plates. Because the special provisions state this requirement, it is not necessary to show this detail on the plan sheets.

### 5.13.4 Routing Conduit to Pedestals

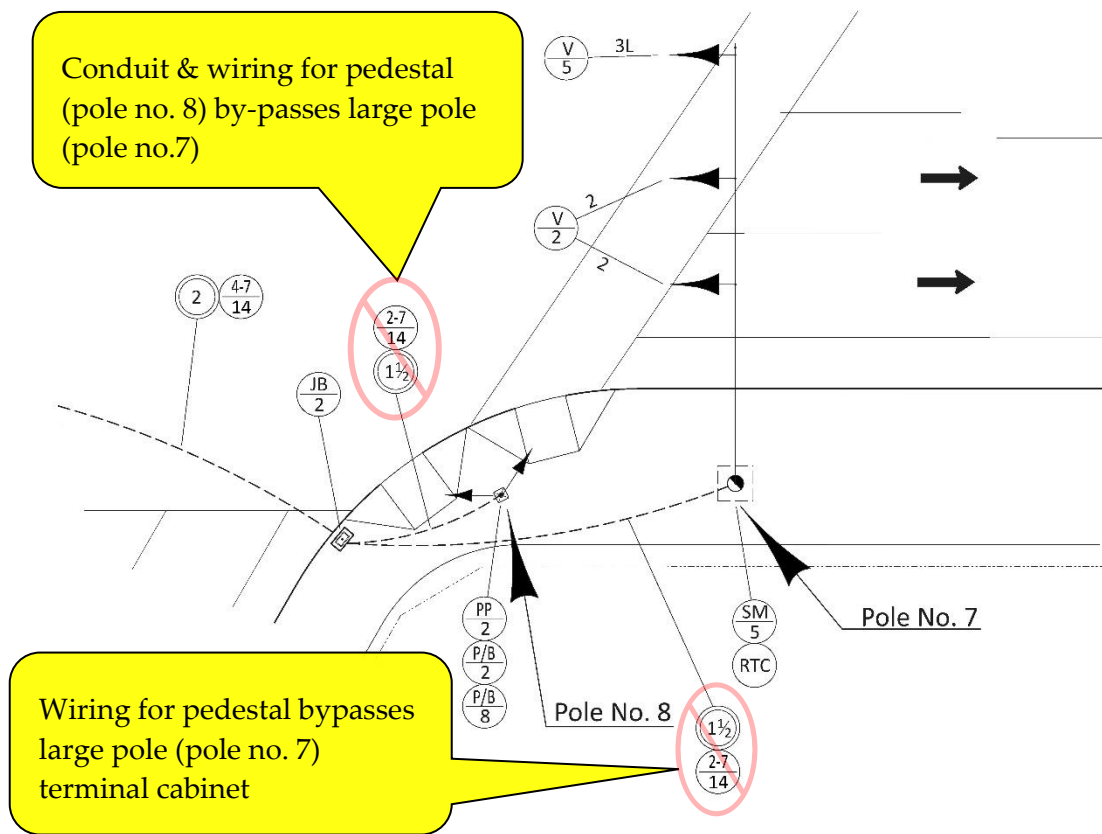
When a large pole is located in the same quadrant as pedestals, route the conduit from the junction box in the same quadrant to the large pole, then from the large pole to the pedestal(s). The wiring for the pedestal will be spliced in the terminal cabinet of the large pole. Routing the conduit and wiring this way allows for easy replacement of the pedestal and wiring to the pedestal in the event of a pedestal knock-down (all pedestals are designed to break-away) due to the splice point in the large pole terminal cabinet. See Figure 5-116.

Figure 5-116 | Conduit Routing to Pedestal with Large Pole in Same Quadrant – Preferred Method



Do NOT route conduit from the junction box in the same quadrant directly to the pedestal(s) when a large pole is located in the same quadrant. See Figure 5-117. However, for retro-fit projects (e.g., adding pedestals to an existing signal due to curb ramp reconstruction), this is likely the only feasible option, as installing a new conduit in an existing pole foundation should be avoided when possible.

Figure 5-117 | Conduit Routing to Pedestal with Large Pole in Same Quadrant – Avoid This Method





When a large pole is NOT located in the same quadrant as the pedestal (e.g., T-intersection), the conduit should route from a junction box in that quadrant to the pedestal, as shown in Figure 5-118. Do NOT route conduit directly to the pedestal. See Figure 5-119.

Figure 5-118 | Conduit Routing to Pedestal Not Located in Same Quadrant as Large Pole – Preferred Method

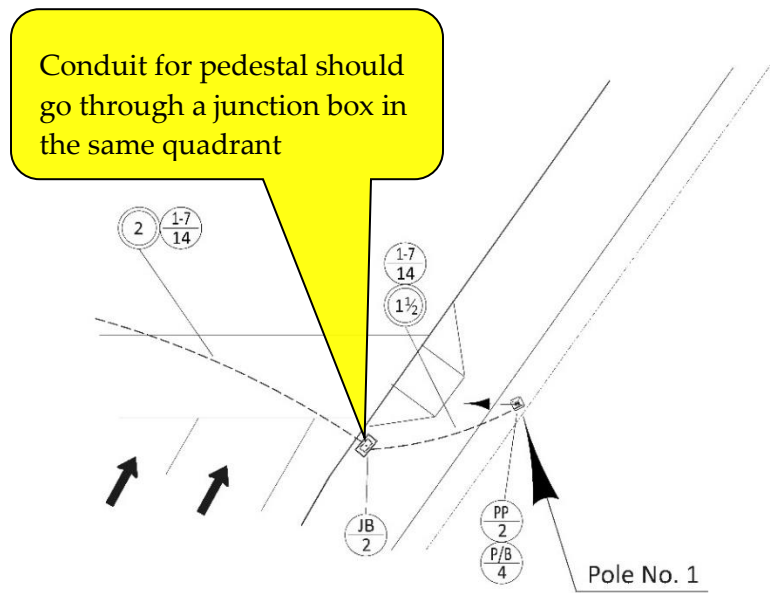
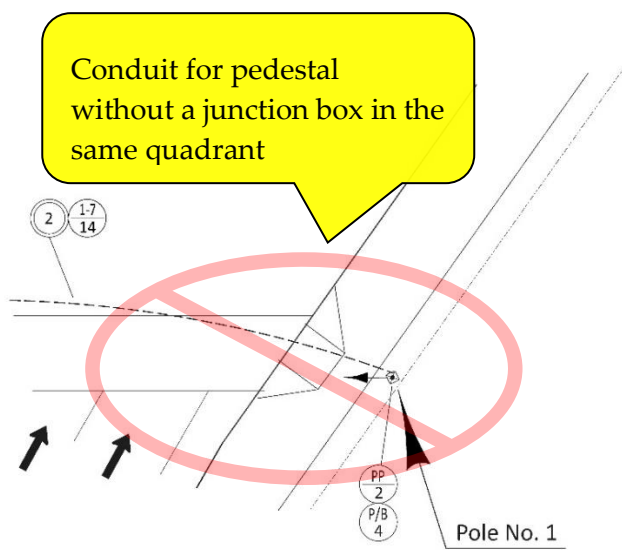


Figure 5-119 | Conduit Routing to Pedestal Not Located in Same Quadrant as Large Pole – Avoid This Method



## **5.13.5 Conduit Trenching Depths & Underground Conflicts**

Retro-fit projects often change the existing finish grade elevations which requires attention to how existing conduits will be impacted. ODOT standard conduit cover is shown on TM471 and ranges from 18 inches to 30 inches (or as per the permit if the permit requires depths that are greater) depending on where the conduit is located. If the finish grade elevations are lowered, the existing conduit may need to be reinstalled at the correct depth. Also note that existing conduits may not have been installed at or adjusted to the current required depths on past projects.

Information on conduit depth during the design phase is typically not available, forcing solutions to be explored during the construction phase as they are discovered. However, the region electricians are good sources of info for site-specific issues (based on past inspections or problems they have encountered over the years) and should be consulted to verify any known issues during the design phase.

If the finish elevation grade is being lowered significantly, there is known issues with shallow conduit, or construction activities discover a shallow conduit, the impacted conduits should be replaced by new conduit installed at the current depth requirements. If this is not possible, either due to the scope of work, budget, or construction timelines, other solutions may be considered such as following the NEC minimum cover standard of 6 inches with conduit encased in concrete. Contact the state traffic signal engineer for approval of using this option and for additional site-specific design requirements.

Underground utilities can also cause conflicts when installing conduits. Conduits that will cross any existing utilities or that will be installed close to an existing utility should be identified. Depending on the situation, the utility or the conduit may need to be relocated, a different installation method may be desirable (horizontal directional drilling vs. open trench) or custom instructions may be needed on the plan sheets. See chapter 8 for more details about identifying utility conflicts and working with the region utility specialist to mitigate any anticipated issues.

**Adjustment of any existing conduit may require replacing/splicing existing conduit (which requires re-installing wiring). Verify with region electrical crew if the existing wiring can be re-installed or if all new wire should be installed. If the traffic signal condition rating is low or the signal is over 20 years old, re-installing existing wire is not recommended.**

## 5.14 Wiring

Traffic signals have three distinct systems for wiring based on the voltage used:

- 120V AC for all signal indications (includes both vehicle and pedestrian indications)
- 240V AC for illumination that is part of the traffic signal
- 24V DC for pedestrian pushbuttons and vehicle detection system

When wiring a traffic signal, NO SPLICING IS ALLOWED!

### 5.14.1 Wire Types

#### Control Cable (multi-conductor cable)

Control cables are multi-conductor cable with assorted stranded copper wires of a particular gauge (No. 14 AWG, No. 12 AWG, etc.). The standard material (wire and insulation) is defined by IMSA (International Municipal Signal Association). The 7-conductor control cable as shown in standard drawing TM470 is used to provide electricity from the controller cabinet to:

- Signal heads
- Pedestrian signal heads
- Pushbuttons

The control cables within a mast arm (from the terminal cabinet to the signal heads) are not shown on the plans but are instead detailed in the standard drawings.

The 7-conductor control cable was chosen as the standard to simplify installation (only one type of cable to bring to the job site), simplify design (one cable for each phase directly from the controller cabinet to the pole terminal cabinet/device), and simplify inspection (one type of cable without extensive color code requirements, easier plan reading). This simplification does have a few downsides such as, larger or more conduit required, higher wiring quantity required, and more spare wires. However, the benefits stated above outweighed these costs.

### Single Conductor Wire THWN

Single conductor wire THWN is used to provide electricity from the controller cabinet to:

- Photo control electronic relay
- Flashing beacons
- PTR signs

Single conductor wire THWN is no longer used in new construction for signal heads, pedestrian signal heads or pushbuttons, but it may still be used for retro-fit projects when the use of control cables is not feasible due to inadequate existing conduit size.

Note there are two exceptions for single conductor wire THWN in new construction as per TM470: wiring in the large signal pole for pedestrian signals and pushbuttons mounted on the large signal pole (see Figure 5-129) and wiring in the ramp meter assemblies for type 8 signal heads (see Figure 5-127).

The color code for single conductor wire is shown in the standard details.

THWN stands for:

- T: Thermoplastic insulation
- H: High temperature (usually 75 °C when dry or damp)
- W: Moisture resistant (usually 60 °C when wet)
- N: Nylon jacket

### Single Conductor Wire XHHW

Single conductor wire XHHW is used to provide electricity from the service cabinet to:

- The in-line fuse holder (located in the pole base) for illumination on the signal pole
- The controller cabinet

XHHW stands for:

- X: Cross-linked synthetic polymer insulation
- HH: Higher temperature (usually 90 °C when dry or damp)
- W: Moisture resistant (usually 60 °C when wet)

### TC Cable

This cable contains three conductors with XHHW insulation with an overall PVC jacket. It is used to provide electricity from the in-line fuse holder (located in the pole base) to:

- The illumination fixture

The TC cable within the pole is not shown on the plans but is instead detailed in the standard specifications.

## 5.14.2 Wire Gauge

The American wire gauge (AWG) is a standardized wire gauge system for the diameters of round, solid conductors. The cross-sectional area of each gauge is an important factor for determining its current carrying capacity. Increasing gauge numbers give decreasing wire diameters.

The standard wire gauges used by ODOT for traffic signal installations are shown below:

- No. 6 AWG is used for:
  - Power from the service cabinet to the controller cabinet
  - Ground/bond wire
- No. 10 AWG is used for illumination
- No. 12 AWG is used for:
  - Power from service cabinet to the photo control electronic relay
  - PTR signs
- No. 14 AWG is used for powering:
  - Signal heads (vehicle/bike)
  - Pedestrian signal heads
  - Pushbuttons
  - System common/system neutral (inclusive in the control cable for the above listed equipment)
  - Flashing beacons

## 5.14.3 Voltage Drop

In certain circumstances, such as a temporary one-lane, two-way traffic signal where the distance between the controller cabinet and the signal equipment is excessive, a larger gauge wire (than the standard) may be needed to power the equipment due to the voltage drop that occurs over the distance of the wire. Voltage drop should not exceed three percent. However, with the use of LED signal heads (which do not require as many watts as an incandescent signal head) the need to use larger gauge wire is now rarely a necessity, even with temporary one-lane, two-way traffic signals.

## **5.14.4 Bonding/ Grounding Requirements**

All ground rods, metal conduit, metal poles, grounding wire, metallic junction boxes, metallic junction box covers, and cabinets shall be mechanically and electrically secure to form a continuous, effectively grounded and bonded system. Typically, a No. 6 AWG stranded copper wire is used for grounding/bonding.

The standard drawings, section 00960.45 of the Oregon Standard Specifications for Construction, and National Electric Code contain all the requirements for bonding and grounding. Because of this, the signal plan sheets typically do NOT show or detail any grounding/bonding requirements. It is recommended that the signal designer consult these sources or contact the region electrical crew for additional information on grounding/bonding.

## **5.14.5 Common/Neutral (Shared) Wire**

A neutral/common wire is needed for each signal system to complete the circuit. There are three separate wiring systems used in traffic signals.

1. 120V AC for signal indications – includes both pedestrian & vehicle indications
2. 24V DC for pedestrian pushbuttons
3. 240V AC for illumination on signal poles (two hot 120V wires, No. 10 AWG XHHW wire, therefore no common/neutral required)

Control cable is used for the first two systems in which the common/neutral is inclusive. If single conductor wiring is used for the first two systems due to a retro-fit project where the existing conduit cannot accommodate control cable, see the [January 2020 version of the Traffic Signal Design Manual](#) for information on common/neutral wiring.

## 5.14.6 Wiring Signal Heads (From Head to Terminal Cabinet)

Each signal indication in a signal head requires a “hot” wire and a “common/neutral” wire in order to complete the circuit. Refer to Figure 5-121 when reading the bulleted text below for a description of the wiring diagram that is used in Figure 5-121 through Figure 5-128 for each signal head type:

- The type 2 signal head shows the hot wiring for each indication (red, yellow, green) entering the signal indication from right side and the common/neutral wiring entering from the left side. This wiring is contained within the signal head itself and NOT shown or detailed on the plan sheets.
- The wiring from the terminal block within the signal head connects to the terminal cabinet located on the signal pole. This wiring is accomplished with a 7-conductor control cable; one for each signal head regardless of type (see Figure 5-120). It is located within the mast arm (or along the span wire for a temporary signal). Note that use of a 7-conductor control cable results in one to three spare wires depending on the type of signal head that is used. This wiring is NOT shown or detailed on the plan sheets for mast arm installations as standard drawing TM470 details this information, but it is shown and detailed on the temporary signal plan sheets for span wire installations.
- From the terminal cabinet on the signal pole one 7-control cable is routed back to the signal controller cabinet (in conduit) to power each signal phase. Note that use of a 7-conductor cable in conduit will have between two and six spare wires depending on the number of phases and indication configuration of the signal head. See 5.14.8 for more info. This wiring is shown and detailed in the plan sheets.

Figure 5-120 | 7-Conductor Control Cable Wiring for Signal Heads (TM470)

7 CONDUCTOR CONTROL CABLE			SIGNAL HEAD TYPES			
			6L* or 3LBF*	4L*, 5* or 7	1R, 1Y 2, 2B, 2BM, 3L, 3LCF, 3R 4 or 9	10*
CONDUCTOR NUMBER	BASE COLOR	FIRST TRACER				
1	WHITE	—	NEUTRAL	NEUTRAL	NEUTRAL	NEUTRAL
2	BLACK	—	YELLOW	YELLOW	YELLOW	YELLOW
3	RED	—	RED	RED	RED	RED 1
4	ORANGE	—	FLASHING YELLOW	TURN YELLOW	SPARE	RED 2
5	GREEN	—	GREEN	GREEN	GREEN	GREEN
6	BLUE	—	SPARE	TURN GREEN	SPARE	SPARE
7	WHITE	BLACK	SPARE	SPARE	SPARE	SPARE

\* Signal heads in standard detail DET4401

Figure 5-121 shows the wiring required for a type 2, 2B, 2BM, 3L, 3R, or 3LCF signal head. These signal head types contain one phase and three functions (red, yellow, and green). The 3LCF signal head yellow indication performs two functions (flashing arrow and solid arrow) via software programming. One “hot” wire for each function (exception is the type 3LCF) and one common/neutral wire is required, resulting in 3 spare wires.

Figure 5-121 | Wiring for Type 2, 2B, 2BM, 3L, 3R, and 3LCF Signal Heads

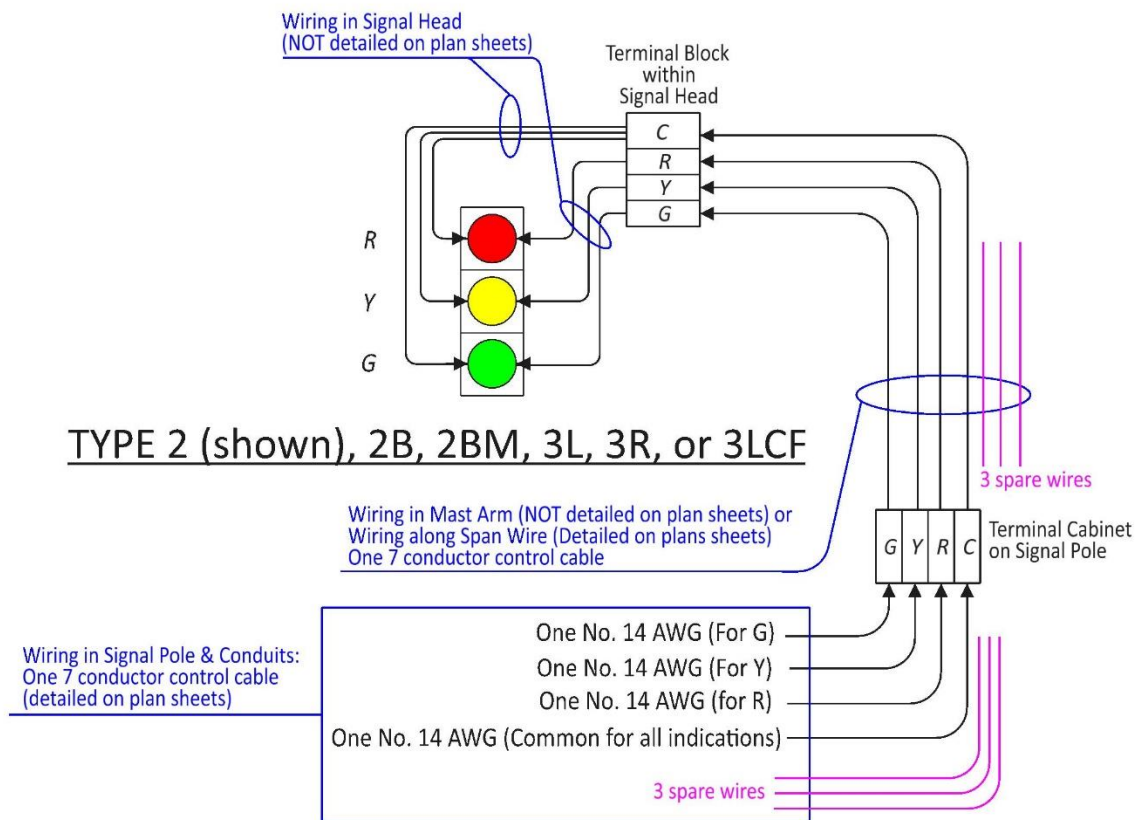




Figure 5-122 shows the wiring required for a type 3LBF signal head. This signal head type contains one phase and four functions (red, yellow, flashing yellow and green). All of the solid arrow indications are wired to the protected left turn phase (typically 1, 3, 5, or 7) and the flashing yellow arrow is wired to an unused overlap phase green (OLA for ph.1 FYA, OLB for ph. 3 FYA, OLC for ph. 5 FYA, and OLD for phase 7 FYA) which via software is linked to the opposing through movement. One “hot” wire for each function and one common/neutral is required, resulting in 2 spare wires.

Figure 5-122 | Wiring for Type 3LBF Signal Head

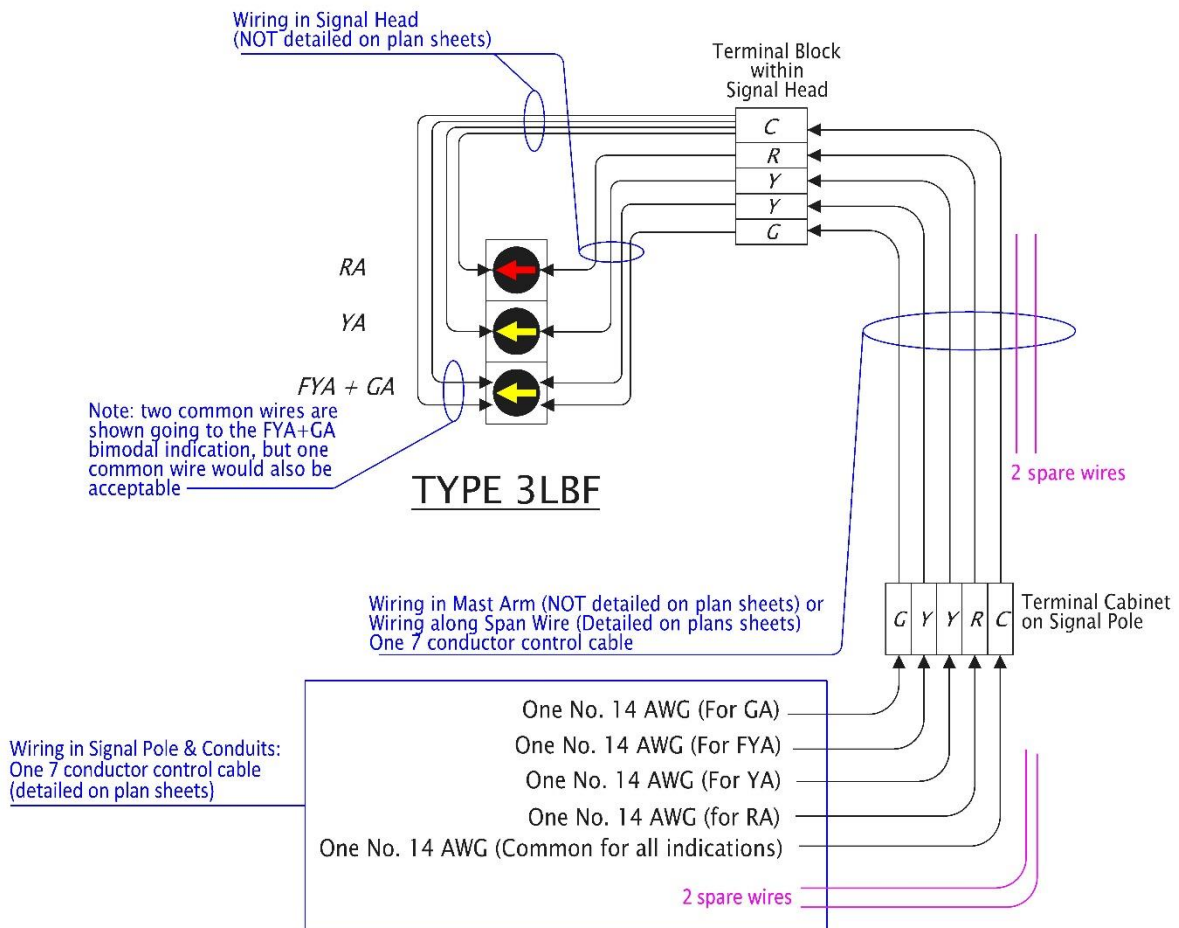


Figure 5-123 shows the wiring required for a type 4 or type 9 signal head. These signal head types contain one phase and three functions (red, yellow, and green). The two green indications always operate together on the same phase. Because of this, the wiring shown and detailed on the plan sheets looks no different than for a type 2 signal head; One “hot” wire for each function and one common/neutral wire is required, resulting in 3 spare wires. The additional wires needed to power each green indication occur within the signal head, which is not shown or detailed on the plan sheets.

Figure 5-123 | Wiring for Type 4 & 9 Signal Heads

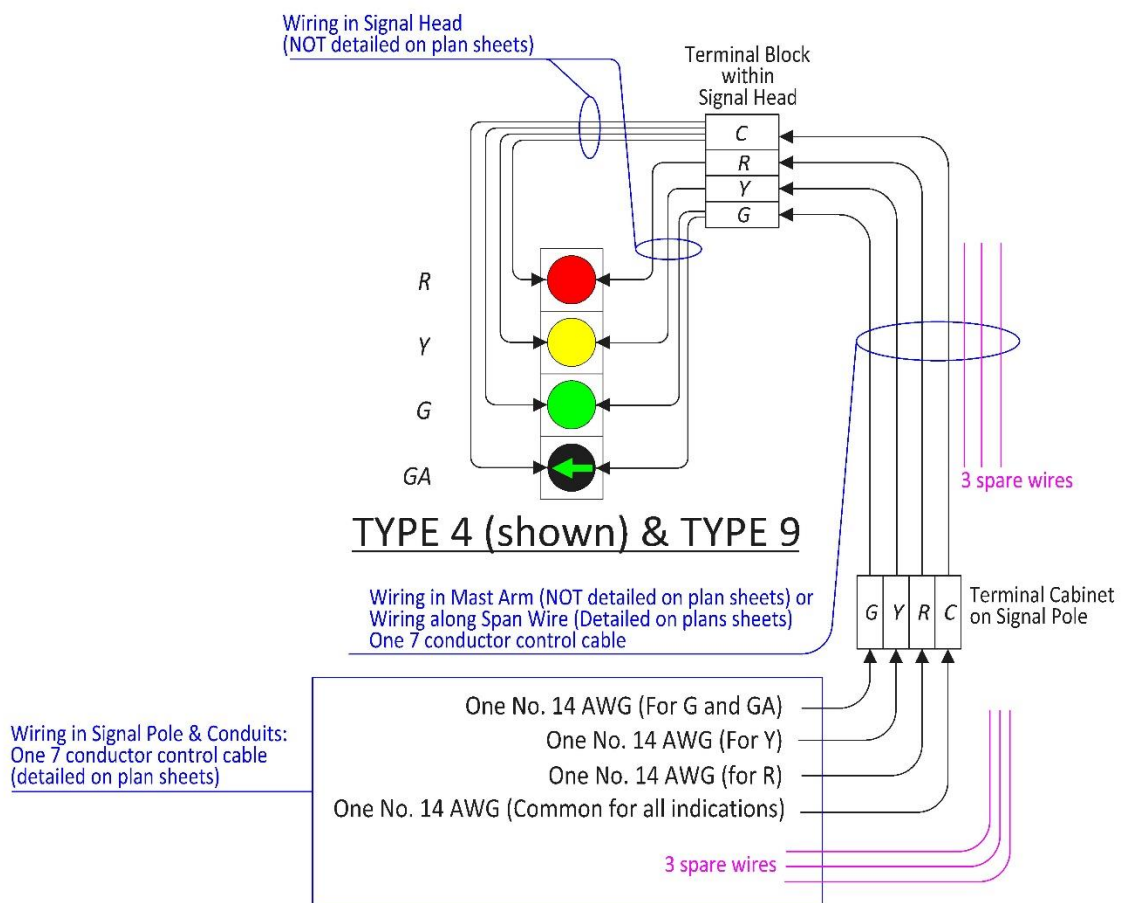


Figure 5-124 shows the wiring required for a type 4L or type 5 signal head. These signal head types contain two separate phases (the arrow indications are for the protected turn phase and the ball indications are for the through phase/permisive turn) and five functions total (red, yellow, and green for one phase and yellow and green arrows for the second phase). All of the ball indications are wired to the through movement phase (typically 2, 4, 6, or 8) and the two arrow indications are wired to the appropriate protected left turn phase (typically 1, 3, 5, or 7). One “hot” wire for each function and one common/neutral wire is required, resulting in 1 spare wire for the control cable in the mast arm. Two conductor cables are required in the conduit (one for each phase) which results in 3 spare wires for one phase, and 5 spare wires for the second phase. Note that the neutral/common is provided by only one of the two required conductor cables in the conduit and it doesn’t matter which control cable provides the neutral/common.

Figure 5-124 | Wiring for Type 4L & 5 Signal Heads

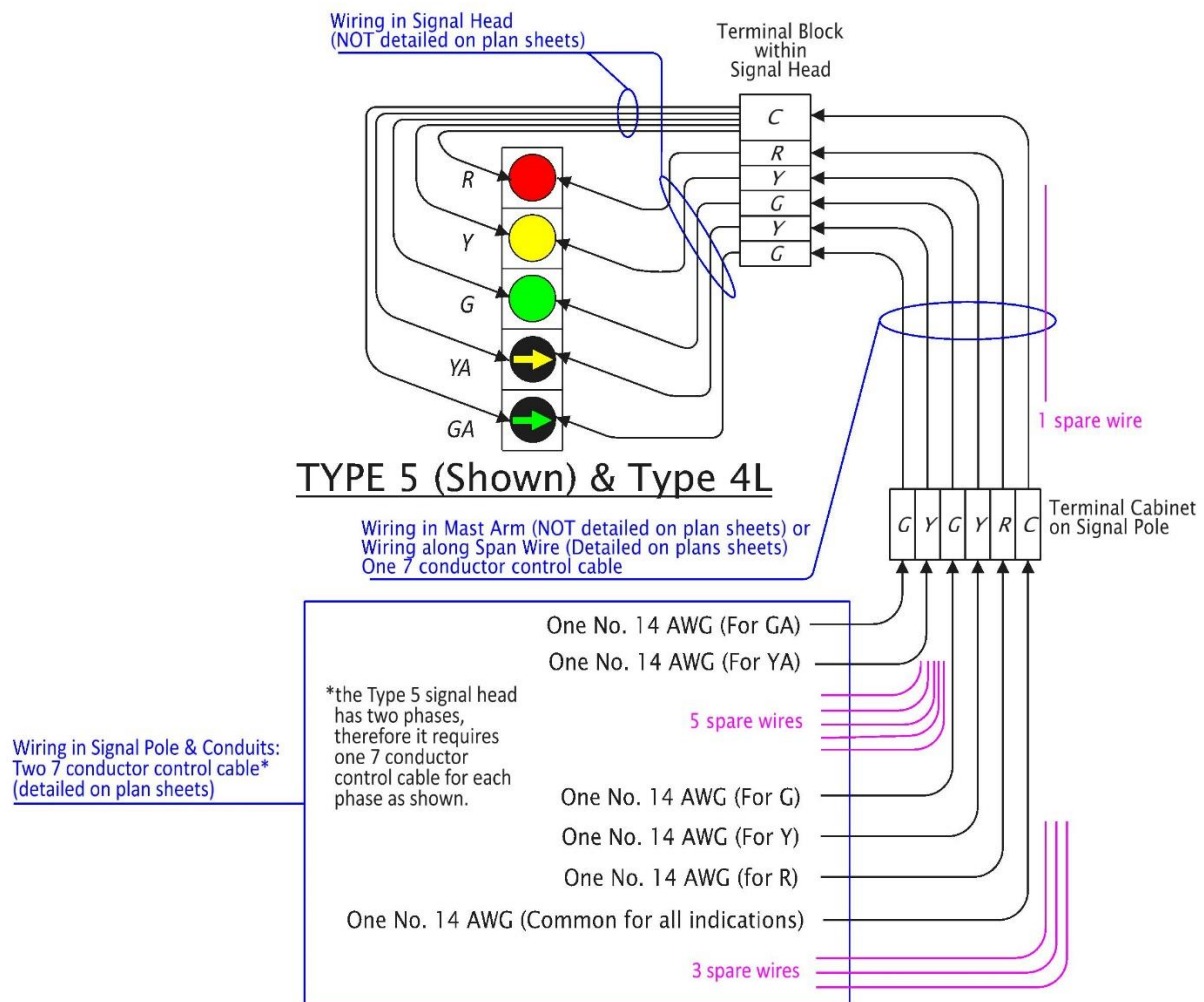


Figure 5-125 shows the wiring required for a type 6L signal head. This signal head type contains one phase (the left turn) and four functions (red, yellow, flashing yellow, and green). All of the solid arrow indications are wired to the protected left turn phase (typically 1, 3, 5, or 7) and the flashing yellow arrow is wired to an overlap phase green (OLA for ph.1 FYA, OLB for ph. 3 FYA, OLC for ph. 5 FYA, and OLD for phase 7 FYA) which via software is linked to the opposing through movement. One “hot” wire for each function and one common/neutral wire is required, resulting in 2 spare wires.

Figure 5-125 | Wiring for Type 6L Signal Head

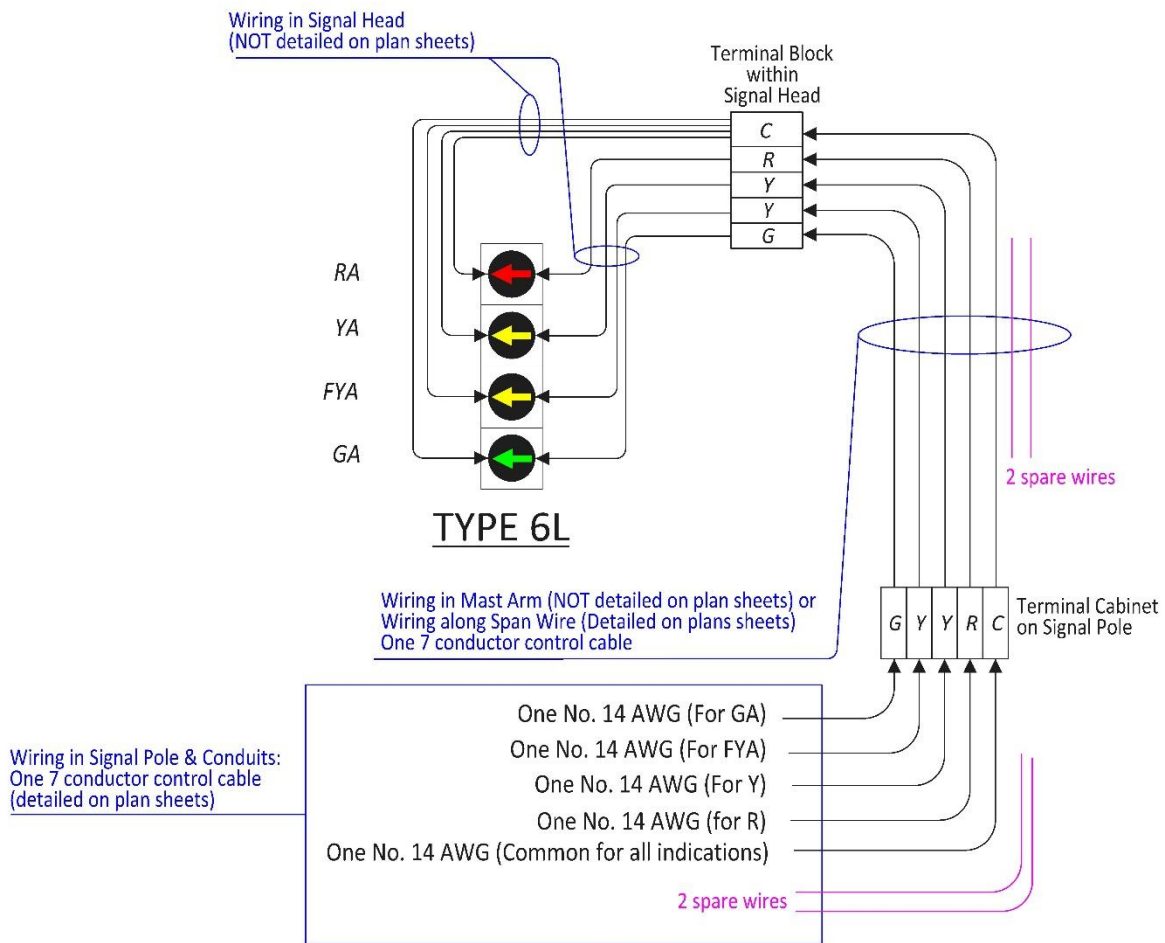


Figure 5-126 shows the wiring requirements for a type 7 signal head. This signal head type contains two separate phases and a total of four functions (red, yellow, and green for one phase and green arrow for the second phase). Unlike the type 4 signal head, the green arrow and green ball operate on the different phases. All of the ball indications are wired to the through movement phase (typically 2, 4, 6, or 8) and the green arrow indication is wired to the adjacent protected left turn phase (typically 1, 3, 5, or 7). This enables the green arrow to only be displayed during railroad preemption and remain dark during normal phase rotation. One “hot” wire for each function and one common/neutral wire is required, resulting in 2 spare wires for the control cable in the mast arm. Two conductor cables are required in the conduit (one for each phase) which results in 3 spare wires for one phase, and 6 spare wires for the second phase. Note that the neutral/common is provided by only one of the two required conductor cables in the conduit and it doesn’t matter which control cable provides the neutral/common.

Figure 5-126 | Wiring for Type 7 Signal Head

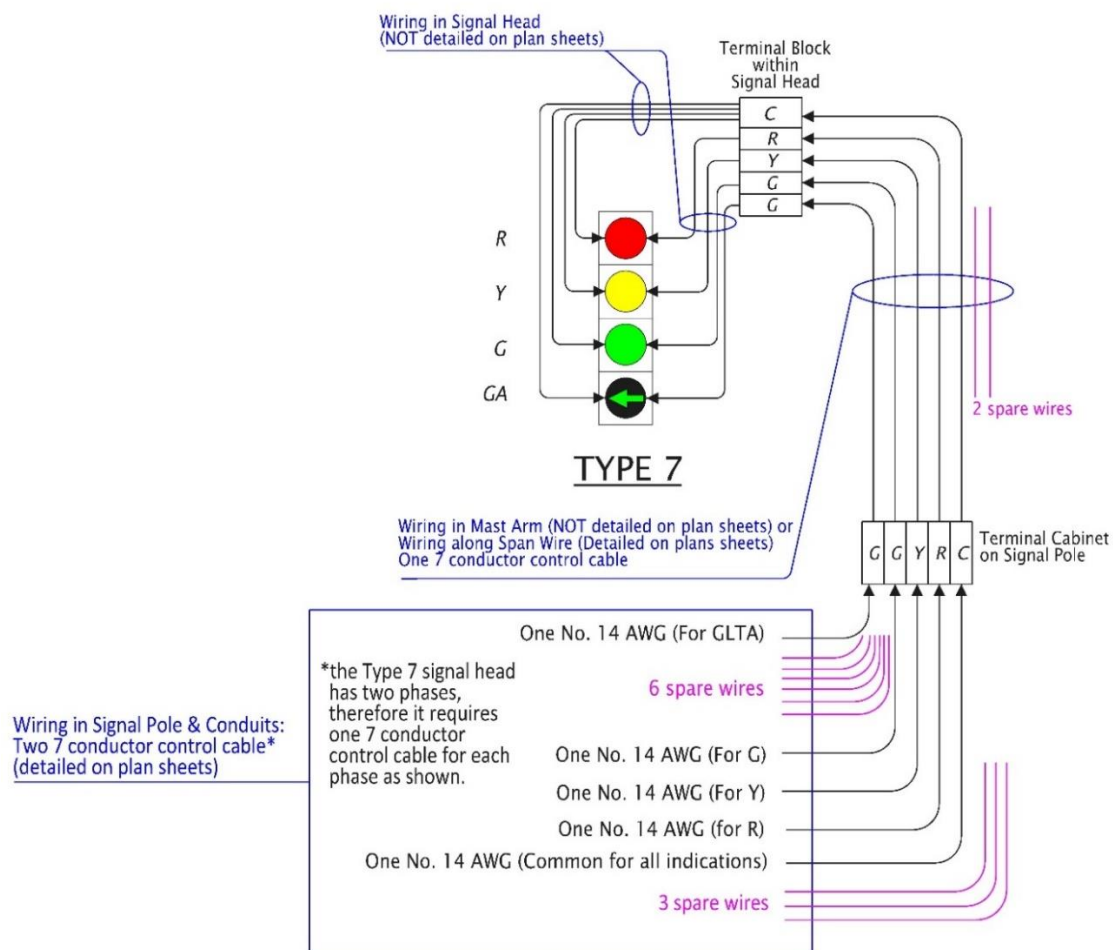


Figure 5-127 show the wiring requirements for a type 8 signal head. This signal head type contains one phase and two functions (red and green). This signal head type is for a ramp meter and is always mounted on a pedestal with a type 2 signal head above it as per standard drawing TM492. Standard drawing TM470 requires the type 8 signal head to be wired from the above mounted type 2 signal head terminal block with No. 14 AWG THWN single conductor wires because there is no terminal cabinet for a pedestal. One “hot” wire for each function and one common/neutral wire is required. Wiring in the conduit contains one 7 conductor cable that is terminated in the type 2 signal head terminal block.

Figure 5-127 | Wiring for Type 8 Signal Head

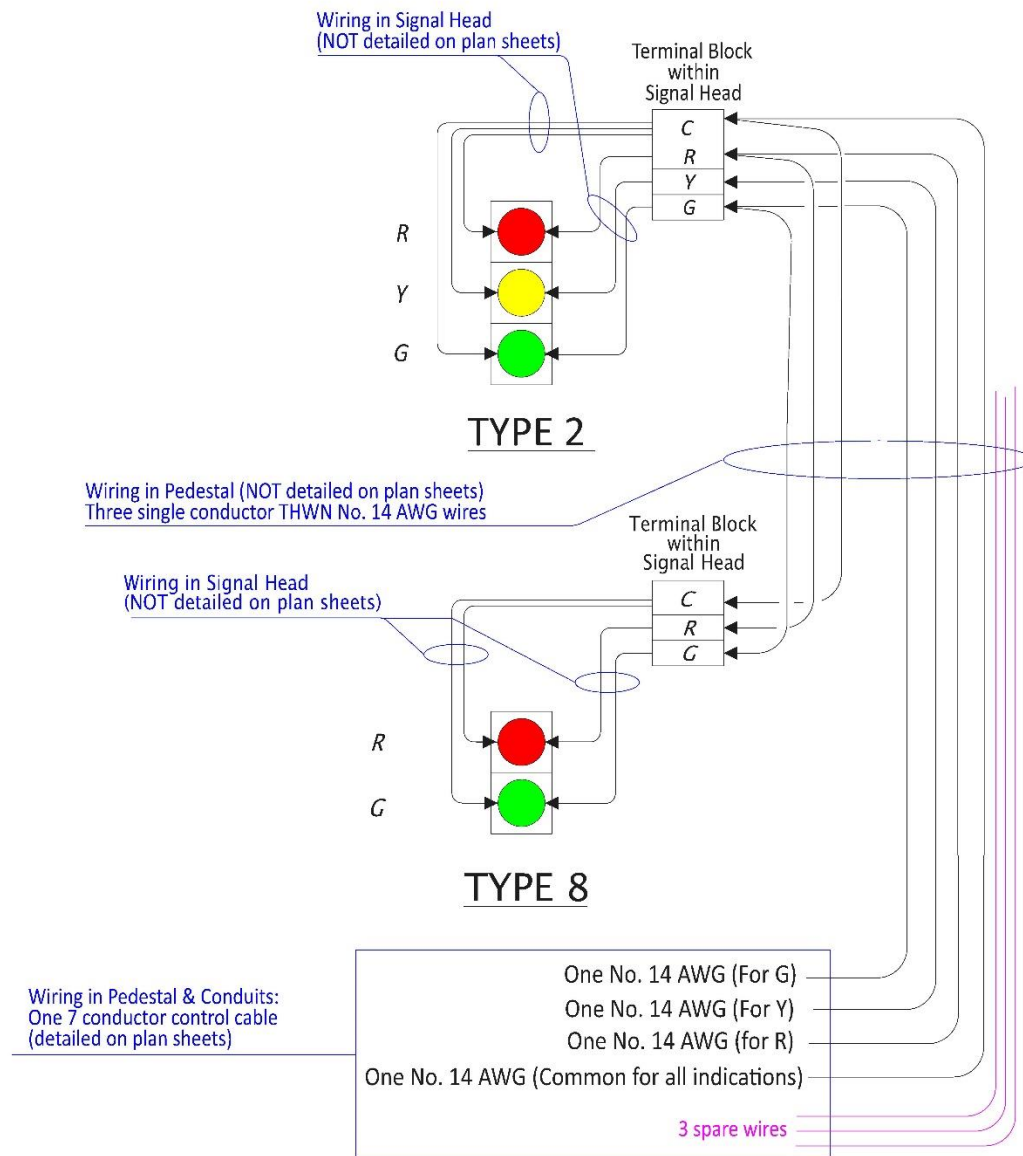
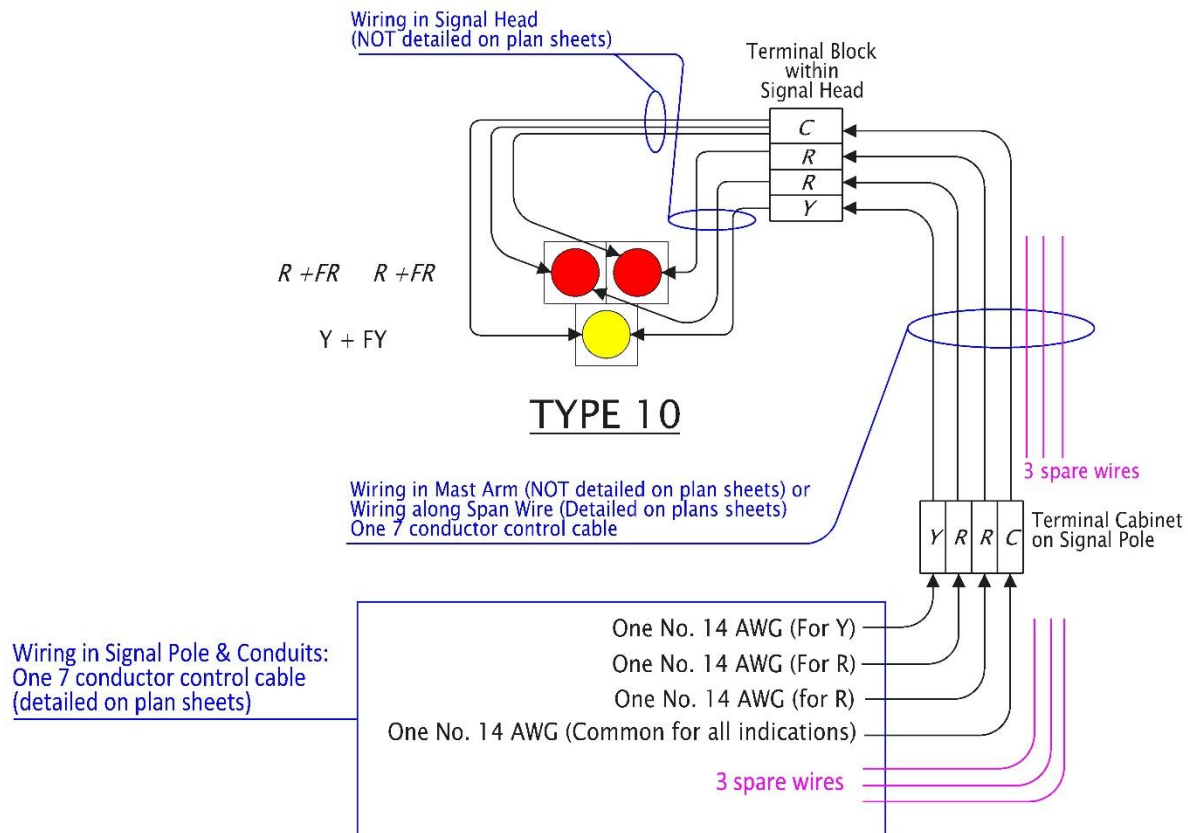


Figure 5-128 shows the wiring requirements for a type 10 signal head. This signal head type contains one phase and two functions (red and yellow). However, the red function is comprised of two indications that must operate in a “wig-wag” pattern (one off, one on and visa-versa) and therefore requires a separate wire for each indication. This results in a total of three “hot” wires, one common/neutral, and 3 spare wires.

Figure 5-128 | Wiring for Type 10 Signal Head



## 5.14.7 Wiring Pedestrian Signals and Pushbuttons

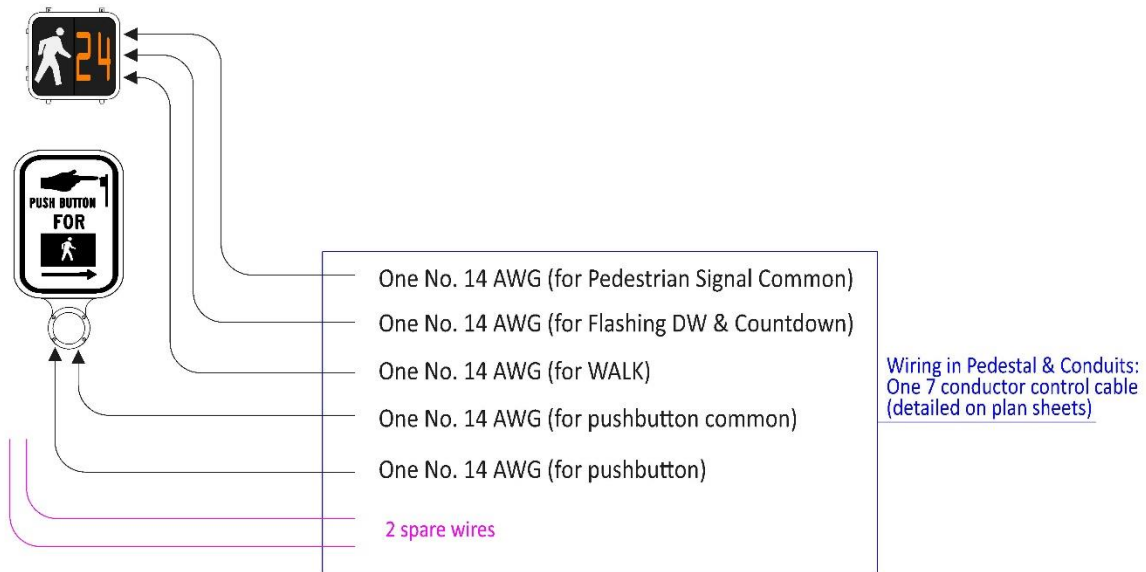
Figure 5-129 shows the requirements for a pedestrian signal and pushbutton mounted on a pedestal and mounted on a larger signal pole (typically both the pedestrian signal and pushbutton for the same phase are mounted on the same support and therefore require one 7 conductor control cable as shown). Standard drawing TM470 requires the pedestrian signals and pushbuttons mounted on signal poles to be wired from the signal pole terminal cabinet to the equipment with No. 14 AWG THWN single conductor wires as shown.

Pedestrian signal heads contain one phase and two functions (walk and flashing don't walk). The countdown indication is inclusive to the flashing don't walk wiring. Pedestrian pushbuttons contain one phase and one function (contact closure of the pushbutton to provide one input to the controller). One "hot" wire for each function and one common/neutral wire is required for the pedestrian signal (total of 3 wires) and for the pushbutton (total of 2 wires), resulting in 2 spare wires. A separate common/neutral wire is required for the pedestrian signal and the pushbutton. This is because the pedestrian signal and pushbutton operate on two different voltage systems (pedestrian signal on a 120V AC system and the pushbutton on a 24V DC system).

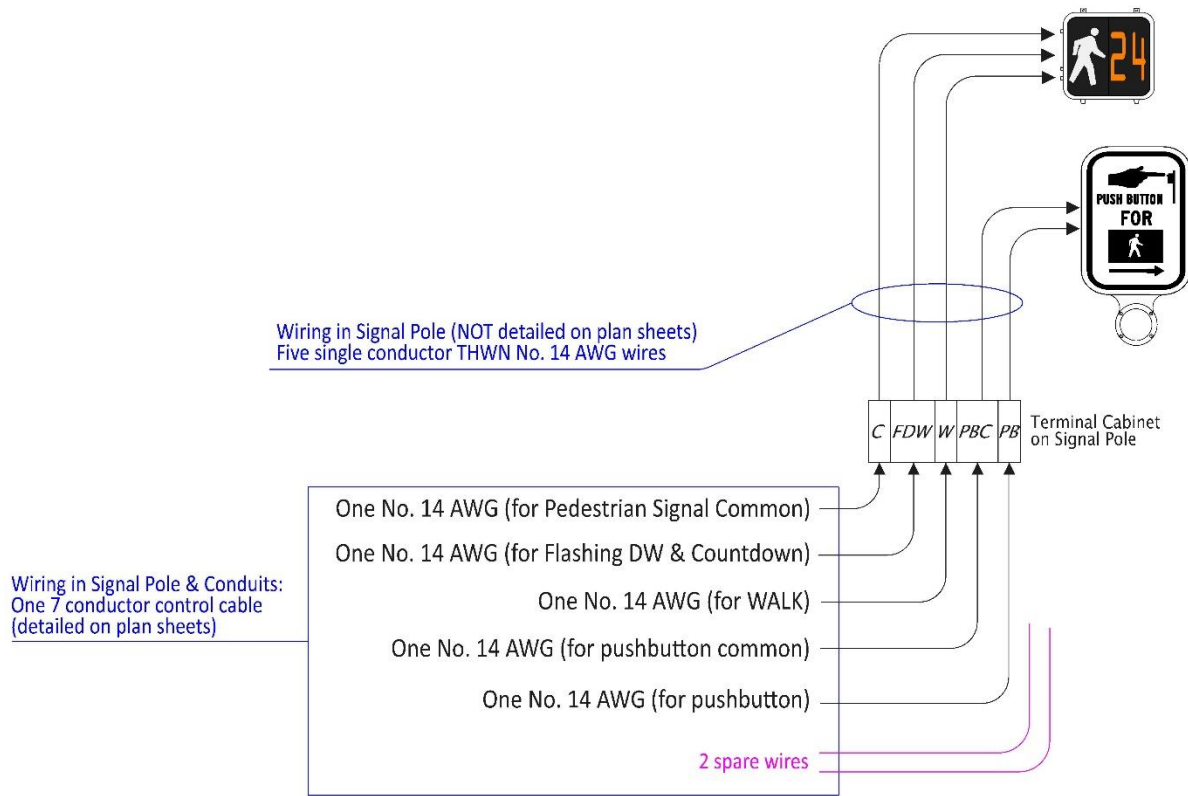
If the pedestrian signal head and pushbutton for the same phase are mounted on different supports, one 7 conductor cable would be used for each piece of equipment. This results in 5 spare wires for a pushbutton and 4 spare wires for a pedestrian signal.



Figure 5-129 | Pedestrian Indication and Pushbutton Wiring



Equipment Mounted on a Pedestal



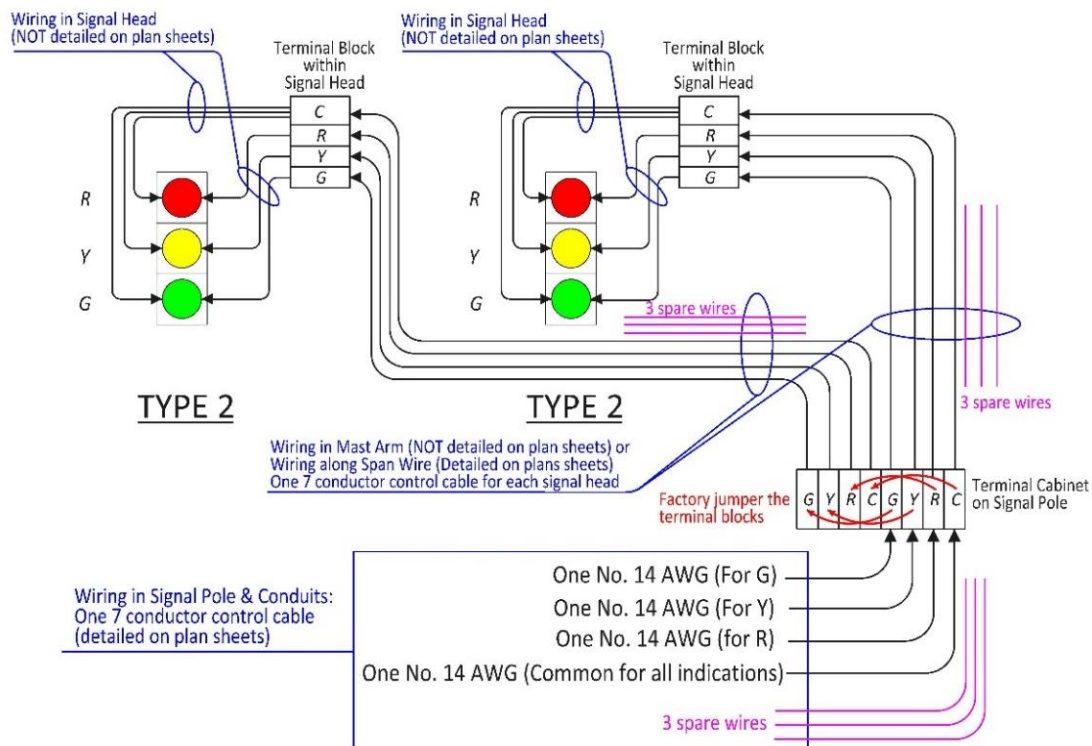
Equipment Mounted on a Large Pole

## 5.14.8 Wiring Signal Phases (from Terminal Cabinet to Controller)

The previous sections detailed how each signal head needs to be wired, while this section focuses on how each signal *phase* is wired (wiring from the terminal cabinet on the signal pole to the controller).

Multiple signal heads (located on the same pole) are often needed for one phase. Figure 5-130 shows one of the most common applications; two signal heads for one through movement phase (typically phases 2, 4, 6, or 8). Only one 7-conductor cable is needed for each phase, regardless of the number of signal heads that that phase has. Figure 5-130 shows three “hot” wires, one common/neutral, and 3 spare wires of the control cable from the controller cabinet to the terminal cabinet on signal pole. “Factory jumpers” are used on the terminal block within the terminal cabinet on the signal pole to provide power to the additional signal head. If a third signal head was added to the same phase, the same “hot” wires and one common/neutral of the control cable would be used from the controller cabinet to the terminal block on the signal pole, but an additional set of jumpers in the terminal cabinet on the signal pole would be used to power the third signal head. This principle of using jumpers in the terminal cabinet on the signal pole applies to any number of signal heads that are intended to operate on the same phase (on the same pole).

Figure 5-130 | Wiring Multiple Signal Heads for the Same Phase on the Same Pole

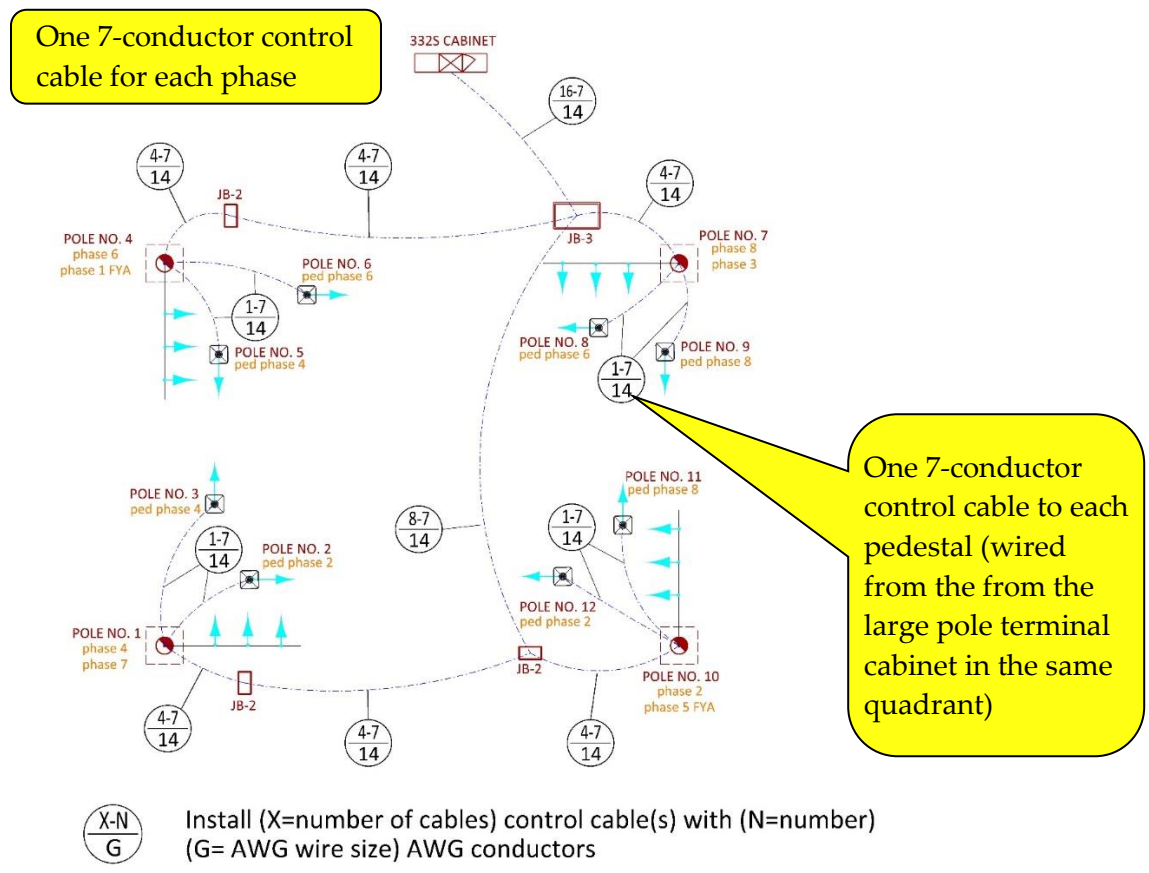


Using 7-conductor control cables is the default standard for wiring phases from the controller cabinet to terminal cabinet (in conduits). One 7-conductor control cable is required per phase (vehicle and pedestrian) from the controller cabinet to the pole terminal cabinet. See Figure 5-131 and Figure 5-132 for examples.

Figure 5-131 | 7-Conductor Control Cable Wiring For Signal Phases (TM470)

7 CONDUCTOR CONTROL CABLE			PEDESTRIAN PHASES	VEHICLE PHASES
CONDUCTOR NUMBER	BASE COLOR	FIRST TRACER	1 PEDESTRIAN PHASE	1 VEHICLE PHASE
1	WHITE	—	NEUTRAL	NEUTRAL
2	BLACK	—	WALK	YELLOW
3	RED	—	DONT WALK	RED
4	ORANGE	—	P.B. COMMON	SPARE
5	GREEN	—	PUSHBUTTON	GREEN
6	BLUE	—	SPARE	SPARE
7	WHITE	BLACK	SPARE	SPARE

Figure 5-132 | Wiring Phases with Control Cables



## 5.14.9 Wire Fill at the Terminal Cabinet Entrance and Mast Arm Connection

There are two critical locations on the mast arm pole that limit the amount of control cables that can be used within the pole and should be verified:

- **The external terminal cabinet entrance (only applicable for retro-fit projects with existing signal poles that have external terminal cabinets):** The terminal cabinet entrance dimension is through a 2 ½ inch diameter factory installed hub. This can accommodate a maximum of 16, 7-conductor control cables with No. 14 AWG conductors, using a 60% max fill rate as per the NEC for conduit and tubing nipples that do not exceed 24 inches in length. As per current wiring standards, the external terminal cabinet entrance will contain control cables going into the terminal cabinet (from the signal controller cabinet) and control cables going out of the terminal cabinet (to the equipment mounted on the pole and mast arm). See Figure 5-133.
- **The mast arm connection:** The mast arm connection dimension is a 2-inch diameter pipe sleeve. This can accommodate a maximum of 11, 7-conductor control cables with No. 14 AWG conductors, using a 60% max fill rate as per the NEC for conduit and tubing nipples that do not exceed 24 inches in length. The mast arm connection will contain all control cables from the terminal cabinet to the equipment located on the mast arm. See Figure 5-133 (existing external terminal cabinet only) and Figure 5-134 (recessed terminal cabinet).

Figure 5-133 | Verify Wire Fill at Terminal Cabinet and Mast Arm Connection (External Terminal Cabinet. Retro-Fits Only)

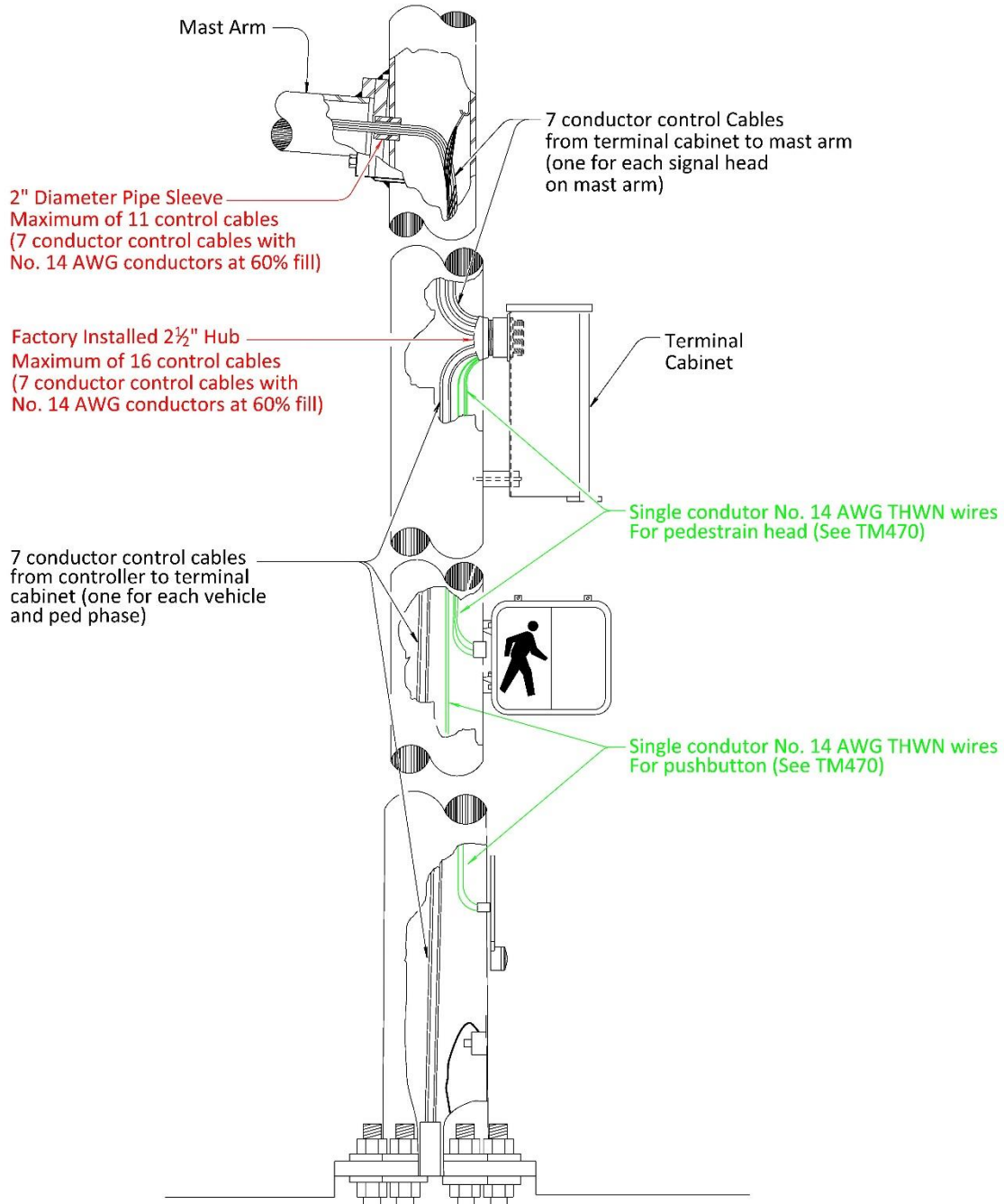
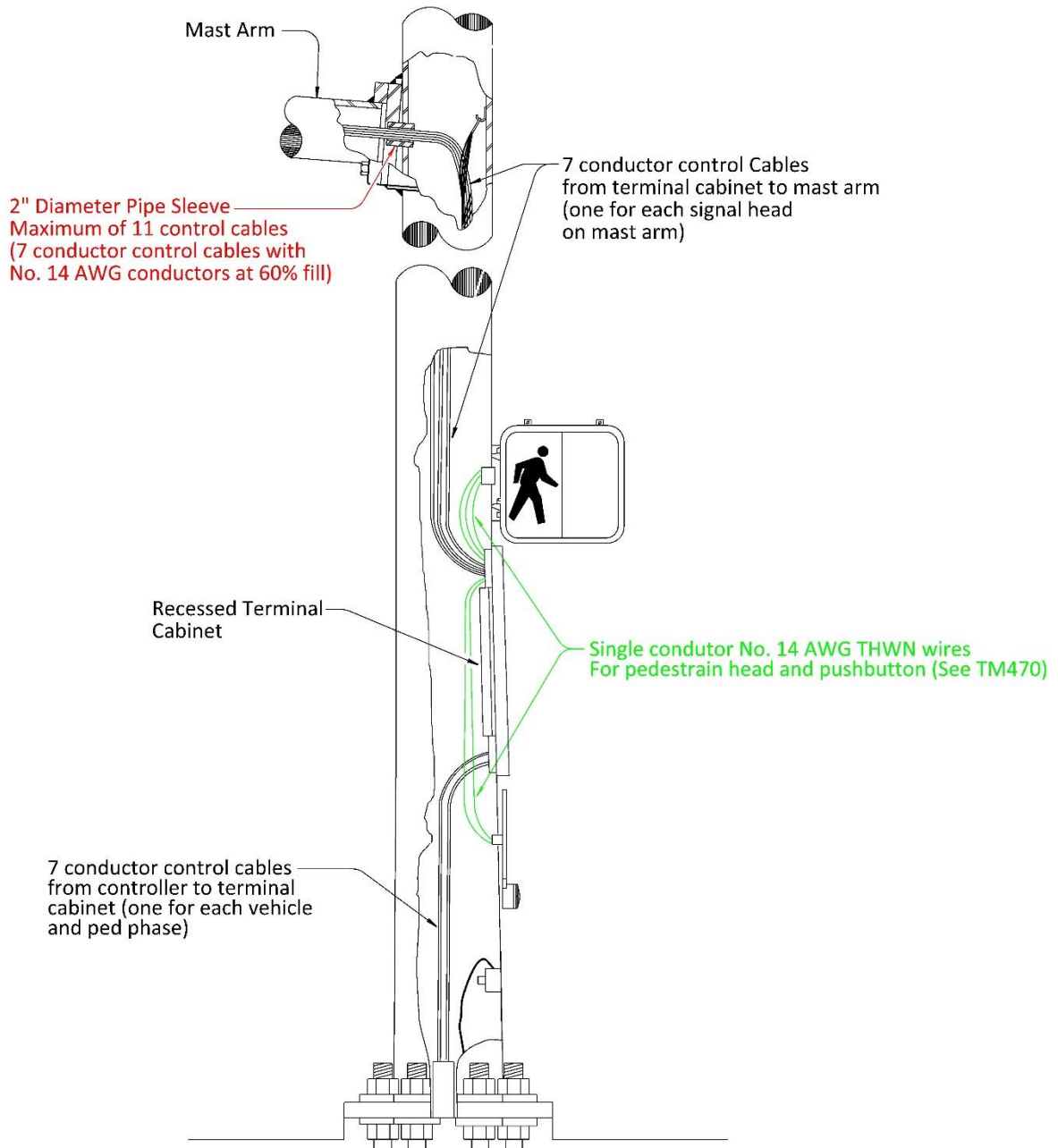


Figure 5-134 | Verify Wire Fill at Mast Arm Connection (Recessed Terminal Cabinet)



## 5.14.10 Wiring Part Time Restriction (PTR) signs

The only function of the part time restriction (PTR) sign is on or off. Therefore, only two THWN No. 12 AWG wires are required for it to function; one “hot” wire for the PTR sign and one wire for the common/neutral to complete the circuit. If using a control cable, a No. 12 AWG two conductor control cable is used. Using a No. 12 AWG wire helps easily identify the PTR wiring at a glance in the field.

## 5.15 Background/Reference Information

This section contains more in-depth information to aid in understanding guidance presented in this chapter.

### 5.15.1 Wiring History

This section has been provided for information and documentation purposes only.

Control cable with a variety of conductors (e.g., four, five, six, ten, twelve, and fifteen conductor control cables) have been used in the past for certain signal heads and certain combinations of phases to be more efficient (result in less cost and less spare wires). The decision to use 7-conductor control cables for all signal wiring was made for the following reasons:

- The cost savings between a four, five and six conductor control cable (for signal heads) verses a seven conductor control is not significant (less than a dollar/foot difference)
- The additional spare wires are beneficial for potential future uses (no need to pull more wire)
- Consistency
- Ease of construction (only need to buy and use one type of control cable for all signal heads)
- Large quantity unit pricing (instead of needing several different sizes of control cable for the various types of signal heads, seven conductor control cable can be purchased in a larger quantity for all signal heads)

### 5.15.2 Type 3LCF Signal Heads for Flashing Yellow Arrow

On August 12<sup>th</sup> 2014 FHWA issued Interim Approval for the optional use of three section flashing yellow arrow signal faces (IA-17):

[https://mutcd.fhwa.dot.gov/resources/interim\\_approval/ia17/ia17.pdf](https://mutcd.fhwa.dot.gov/resources/interim_approval/ia17/ia17.pdf)

On December 11<sup>th</sup> 2014 ODOT received approval from FHWA to install three section center flashing arrows as part of IA-17:

[https://www.oregon.gov/ODOT/Engineering/Documents\\_TrafficStandards/FHWA-IA-17\\_Oregon-Use.pdf](https://www.oregon.gov/ODOT/Engineering/Documents_TrafficStandards/FHWA-IA-17_Oregon-Use.pdf)

The following list contains the reasons why three section center flashing arrows were pursued as the ODOT standard:

1. Physical characteristic of the 3 section center flashing arrow signal head
  - a. Structural loading between 3 section protected only and 3 section center flash are the same.
    - i. This is not the case when using a four section FYA signal head which is 14 inches taller.
  - b. Vertical clearance between 3 section protected only and 3 section center flash are the same.
    - i. This is not the case when using a four section FYA signal head which is 14 inches taller.
  - c. Maintenance is allowed to standardize parts since the 3 section head can be used for protected only, PPLT, and permissive only operation.
    - i. This is not the case when using the four section head.
  - d. Maintenance is allowed to standardize LED modules. They only need six LED modules to allow any operation: Red/Yellow/Green balls and Red/Yellow/Green arrows.
    - i. This is not the case when using bimodal green/yellow arrow LED modules.
      1. Note: The bimodal green/yellow arrow LED modules are not supported by the ITE specification for LED modules.
  - e. Outputs from the controller cabinet remain the same to run protected only or center flash PPLT: Three wires.
    - i. This is not the case when using the four section head: Requires four wires.
    - ii. This is not the case when using the bimodal LED module: Requires four wires.
  - f. Three section center flash is an easy conversion from 3 section protected only. Requires cabinet modifications only.
    - i. This is not the case when using the four section head: Requires a head change out and adding one wire from the cabinet
    - ii. This is not the case when using the three section bimodal green/yellow LED module: Requires the change out of one LED module and adding one wire from the cabinet.
2. Safety and operational characteristic of the 3 section center flashing arrow signal head
  - a. Research completed on the 3 section center flash as noted in IA-17: <http://apps.trb.org/cmsfeed/trbnetprojectdisplay.asp?projectid=2763>
  - b. Quote from IA-17 “The research results demonstrated that a three-section FYA signal face in which the middle yellow arrow signal indication is used to display both the steady change interval and the flashing yellow permissive interval provides a safe and effective operation for road users”
3. Currently there are three options for flashing yellow arrow head types: Three section center flash, three section bottom bimodal green/yellow, and four section. All three are







acceptable options and are considered equals for operations and safety. But when considering physical characteristics and ease of maintenance for the 1,500 traffic signals and numerous personnel that work on them on the state highways the three section center flash is the best option.

### 5.15.3 Sign History

Figure 5-135 below shows a list of signs that are no longer used. It is by no means all inclusive, but is included in this manual for historical purposes.

Figure 5-135 | Signs No Longer Used

<i>SIGNS NO LONGER USED</i>		
<i>OR10-10L</i> <i>30"x36"</i>		<i>"LEFT TURN SIGNAL" sign</i>
<i>OR10-10R</i> <i>30"x36"</i>		<i>"RIGHT TURN SIGNAL" sign</i>
<i>OR17-1</i> <i>30"x36"</i>		<i>"LEFT TURN YIELD TO ONCOMING TRAFFIC" sign replaced by R10-12</i>
<i>OR22-14</i> <i>30"x36"</i>		<i>"RIGHT TURN YIELD TO PEDS ON GREEN ball symbol" sign replaced by OR10-15</i>