

H

O

I

SEATING

JULY 2018 LIST PRICER

Effective Date July 1, 2018
Supersedes HON Seating List Pricer
Dated January 1, 2018

MADE IN THE
USA 
SEE PAGE 5





CHAIR CONFIGURATOR

HON's Chair Configurator allows you to choose from thousands of fabrics to dress up your chair just the way you want it - the opportunities are endless.

hon.com/configurator

TABLE OF CONTENTS

By Series Name

BY SERIES NAME

| | |
|---|---------|
| Accommodate® | 32-38 |
| Adjustable Task/Lab Stools | 39 |
| Assemble™ | 40-41 |
| Boda™ | 42-43 |
| Cambia™ 2160 Series | 44-46 |
| Ceres® | 47-52 |
| Charge™ | 53 |
| Circulate™ | 54 |
| Client™ | 55 |
| ComforTask® 5900 Series | 56-60 |
| Convera™ Lounge | 63-65 |
| Convergence® | 66-70 |
| Corral™ | 71 |
| Contemporary Occasional Tables | 72 |
| Crio | 73 |
| Define™ | 74 |
| Endorse® Collection | 75-86 |
| Entire™ | 87 |
| Exposure™ | 88 |
| Flock® | 89-122 |
| Gamut® 2070 Series | 123-125 |
| Greet™ | 126-127 |
| Grove® | 128-140 |
| GuestStacker® 4030 Series | 141-142 |
| Ignition® | 143-163 |
| Instigate™ | 164 |
| Invitation® 2110 Series | 165-168 |
| Invitation® Lounge | 169-171 |
| Lota® | 172-177 |
| Motivate® Chairs | 178-197 |
| Network™ | 198 |
| Nucleus® | 199-204 |
| High-Density Olson Stacker® 4040 Series | 205-206 |
| Pagoda® | 207-214 |
| Park Avenue Collection® 5000 Series | 215-217 |
| Centerpiece™ Occasional Tables | 218 |
| Park Avenue Collection® 5020 Series | 219-221 |
| Perch™ | 222 |
| Perpetual® Nesting Chairs | 223-225 |
| Pillow-Soft® 2090 Series | 226-228 |
| Pillow-Soft® 2190 Series | 229-231 |
| Prominent™ | 232-233 |
| Purpose® | 234-239 |
| Quotient® | 240-243 |
| Riley™ | 244-251 |
| Scatter™ | 252 |
| SmartLink® | 253-259 |
| Solutions Seating® 4000 Series | 260-262 |
| Solve® | 263-274 |

| | |
|------------------|---------|
| Soothe® | 275-284 |
| Tilt™ | 285 |
| TopFlight™ | 286 |
| Torch™ | 287 |
| Traction™ | 288 |
| Validate™ | 289 |
| ValuTask® | 290 |
| Versant® Tandem | 291-297 |
| Volt® | 298-305 |
| Wave™ | 306 |
| 2400 Series | 307-309 |
| 6540 Series | 310-312 |
| 6550 Series | 313-315 |
| 7800 Series | 316-320 |
| Executive Chairs | 321-323 |
| Guest Chairs | 324 |
| Mesh Chairs | 325 |
| Nesting Chairs | 326 |
| Task Chairs | 327 |
| Workplace Tools | 328-329 |

| | |
|-------------------------|------------------|
| Entire™ | 87 |
| Exposure™ | 88 |
| Gamut® | 125 |
| Ignition® | 148-149, 155-156 |
| Lota® | 175-176 |
| Mesh Chairs | 325 |
| Motivate® | 181 |
| Nucleus® | 203 |
| Park Avenue Collection® | 217, 221 |
| Pillow-Soft® | 228, 231 |
| Prominent™ | 232-233 |
| Purpose® | 237 |
| Quotient® | 243 |
| Solutions Seating® | 262 |
| Solve® | 267-273 |
| Task Chairs | 327 |
| Tilt™ | 285 |
| Torch™ | 287 |
| ValuTask® | 290 |
| Volt® | 300-301, 304-305 |
| Wave™ | 306 |
| 7800 Series | 319-320 |

BY APPLICATION

EXECUTIVE AND CONFERENCE

| | |
|-------------------------|----------|
| Ceres® | 51 |
| Charge™ | 53 |
| Client™ | 55 |
| Define™ | 74 |
| Entire™ | 87 |
| Endorse® | 79, 82 |
| Executive Chairs | 321-323 |
| Exposure™ | 88 |
| Gamut® | 125 |
| Ignition® | 150-151 |
| Nucleus® | 203 |
| Park Avenue Collection® | 217, 221 |
| Pillow-Soft® | 228, 231 |
| Solutions Seating® | 262 |
| TopFlight™ | 286 |
| Traction™ | 288 |
| Validate™ | 289 |
| Wave™ | 306 |
| 6540 Series | 312 |

TASK CHAIRS

| | |
|--------------|-------|
| Boda™ | 43 |
| Ceres® | 51 |
| ComforTask® | 59 |
| Convergence® | 69-70 |
| Crio | 73 |
| Endorse® | 80-82 |

GUEST CHAIRS

| | |
|-------------------------|----------|
| Accommodate® | 35, 37 |
| Cambia™ | 46 |
| Ceres® | 52 |
| Charge™ | 53 |
| Client™ | 55 |
| Flock® | 105-106 |
| Gamut® | 125 |
| Guest Chairs | 324 |
| Ignition® | 159, 161 |
| Instigate™ | 164 |
| Invitation® | 167 |
| Lota® | 177 |
| Nucleus® | 204 |
| Pagoda® | 210-213 |
| Park Avenue Collection® | 217, 221 |
| Pillow-Soft® | 228, 231 |
| Riley™ | 247-250 |
| Solutions Seating® | 262 |
| Soothe® | 279-281 |
| TopFlight™ | 286 |
| Traction™ | 288 |
| Validate™ | 289 |
| Versant® Tandem | 297 |
| 2400 Series | 309 |
| 6540 Series | 312 |
| 6550 Series | 315 |

- All illustrations and specifications in this publication are based on the latest product information available at the time of print. For the most recent version, please go to <https://www.hon.com/pricer>.
- Software support packages furnished to the customer, either by The HON Company or by another source, which support the sale of HON products are superseded by printed price lists.
- All dimensions shown in this publication are nominal.
- Pricing is subject to change without notice.

- All orders are subject to prices in effect at the time of order.
- Ordering information appears at the beginning of a section complete with examples on how to specify. These specifying information pages are referenced at the bottom center of product pages.
- HON Full Lifetime Warranty applies unless otherwise noted.
- HON nationwide customer service:
Phone: (800) 833-3964.

TABLE OF CONTENTS

By Series Name

BY APPLICATION

STACKING AND NESTING CHAIRS

| | |
|-----------------------------|---------------|
| Assemble™ | 40 |
| Ceres® | 52 |
| GuestStacker® | 142 |
| Ignition® | 161 |
| Lota® | 177 |
| Mesh Nesting Chairs | 326 |
| Motivate® | 183, 187, 191 |
| Nucleus® | 204 |
| High-Density Olson Stacker® | 206 |
| Pagoda® | 210-213 |
| Perpetual® | 225 |

COLLABORATIVE AND PUBLIC SPACES

| | |
|-----------------|--------------------------|
| Accomodate® | 35-38 |
| Circulate™ | 54 |
| Convera™ | 65 |
| Corral™ | 71 |
| Endorse® | 85 |
| Flock® | 92-101, 104-106, 109-111 |
| Greet™ | 126 |
| Grove® | 132-134, 136-139 |
| Ignition® | 159-160 |
| Invitation® | 171 |
| Soothe® | 279-282 |
| Versant® Tandem | 295, 297 |

STOOLS AND MULTI-PURPOSE

| | |
|---------------------|-----------------------------|
| Accomodate® | 35-38 |
| Adjustable Task/Lab | 39 |
| ComforTask® | 60 |
| Endorse® | 83 |
| Flock® | 104-106 |
| Ignition® | 151, 160-161 |
| Instigate™ | 164 |
| Lota® | 177 |
| Motivate® | 181, 187-188, 191, 194, 197 |
| Nucleus® | 204 |
| Pagoda® | 214 |
| Perpetual® | 225 |
| Prominent™ | 232-233 |
| Purpose® | 238 |
| Quotient® | 243 |
| Solve® | 267-269, 271-273 |
| Torch™ | 287 |
| Volt® | 300-301, 304-305 |

ACTIVE

| | |
|-----------------|---------|
| Perch™ | 222 |
| Tilt™ | 285 |
| Workplace Tools | 328-329 |

BIG AND TALL

| | |
|-----------|-----|
| Endorse® | 82 |
| Ignition® | 151 |
| Wave™ | 306 |

BIARIATRIC

| | |
|-----------------|----------|
| Accomodate® | 36, 38 |
| Ignition® | 160 |
| Riley™ | 248, 250 |
| Soothe® | 279, 281 |
| Versant® Tandem | 297 |

COORDINATING TABLES

| | |
|--------------------------------|---------|
| Contemporary Occasional Tables | 72 |
| Endorse® | 86 |
| Flock® | 115-120 |
| Invitation® | 168 |
| Centerpiece™ | 218 |
| Riley™ | 251 |
| Soothe® | 283 |
| Versant® Tandem | 296 |

WORKPLACE TOOLS

| | |
|-----------------|---------|
| Workplace Tools | 328-329 |
|-----------------|---------|

- All illustrations and specifications in this publication are based on the latest product information available at the time of print. For the most recent version, please go to hon.com/tools-ideas/resources/pricer.
- Software support packages furnished to the customer, either by The HON Company or by another source, which support the sale of HON products are superseded by printed price lists.
- All dimensions shown in this publication are nominal.
- Pricing is subject to change without notice.

- All orders are subject to prices in effect at the time of order.
- Ordering information appears at the beginning of a section complete with examples on how to specify. These specifying information pages are referenced at the bottom center of product pages.
- HON Full Lifetime Warranty applies unless otherwise noted.
- HON nationwide customer service:
Phone: (800) 833-3964.

NEW ADDITIONS: PRODUCTS

| Seating | Effective Date |
|---|----------------|
| Assemble™ Models HVL304, HVL314 | January 2018 |
| Ceres® Model HCG6DF | September 2017 |
| Convergence® | August 2017 |
| Crio Models HVL581, HVL582, HVL585 | September 2017 |
| Flock® Models HFL450, HFLCC1, HFLCC1DF, HFLMC1S, HFLMC1SDF, HFLRC1S, HFLRC1SDF, HFLSC1S, HFLSC1SDF, HFLWI45, HFLWI45DF, HFLWO45, HFLWO45DF | July 2017 |
| Greet™ Models HVL891, HVL892, HVL893, HVL894, HVL895 | November 2017 |
| Ignition® Models HICS7DF, HIGS6DF, HISB6DF | September 2017 |
| Motivate® Models HMG3, HMG4 | April 2017 |
| Network™ Models HVL281, HVL282, HVL283, HVL289 | February 2018 |
| Pillow-Soft® Model H2095 | October 2017 |
| Prominent™ Models HVL530, HVL536, HVL537, HVL539 | February 2018 |
| SmartLink® Models HSS4L-06A, HSSCL-14A, HSSCL-16B, HSSCL-18B | April 2017 |
| Solve® Models HSLVSMMS, HSLVSMRS, HSLVSMUS, HSLVTMMS, HSLVTMRS, HSLVTMUS | July 2018 |
| Tilt™ Model HVL951 | January 2018 |
| Traction™ Model HVL102 | February 2018 |
| ValuTask® Model HVL206 | October 2017 |

DISCONTINUATIONS

| Seating | Effective Date | Fabrics and Finishes | Effective Date |
|--|----------------|---|----------------|
| 7700 Series Models H7701, H7703, H7705, H7708, H7795, HHW103 | January 2018 | Laminate Light Gray Q Taupe Mesh A8 | January 2018 |
| basyx by HON® Models HVL862, HVL864 | December 2018 | Seating Fabric Arrondi | January 2018 |
| ComfortSelect™ Models HACC1TMM, HSUR2TMM, HXCL2TMM | July 17, 2018 | Carob RO49 Honey RO26 Jet RO10 Lagoon RO96 Sand RO24 Taupe RO22 | January 2018 |
| Folding Chairs Models HFC01, HFC02, HFC32 | January 2018 | Centurion Burgundy CU99 Caramel CU26 Glacier CU96 Tangerine CU46 Tomato CU66 | July 31, 2018 |
| Laurus™ Models H2171, H2172 | January 2018 | Confetti Black AB10 Blue AB90 Burgundy AB62 Gray AB12 | July 31, 2018 |
| Greet™ Modular Lounge Models HVL891, HVL892, HVL893, HVL894, HVL895 | July 3, 2018 | Esplanade Alloy PE22 Berry PE62 Espresso PE49 Flame PE42 Khaki PE26 Lapis PE90 Lawn PE82 Licorice PE10 Oasis PE96 Tourmaline PE78 | January 2018 |
| | | Gio Glow GO40 Icicle GO19 Misty GO92 Mocha GO47 Onyx GO10 Rye GO24 Sage GO80 Vermilion GO60 | January 2018 |
| | | Jamestown Vinyl Black EJ10 Oxblood EJ65 Slate EJ92 | January 2018 |
| | | Sierra Vinyl (Matching vinyl to SS Leather) Black EE11 Brick EE62 Chocolate EE49 | January 2018 |
| | | Tectonic Black NT10 Charcoal NT19 Chive NT78 Mariner NT90 Periwinkle NT85 Taupe NT26 Wine NT69 | July 31, 2018 |

MADE IN THE USA

MADE IN THE
USA 

PROUDLY MADE IN THE USA

When you buy HON office furniture, you're not just buying inspired, practical solutions — you're buying quality, American-built furniture, backed by a lifetime warranty and a network of dealers.

LOOK FOR THIS ICON ON MODEL PAGES: 

USA 

DESIGNED, ENGINEERED
& ASSEMBLED IN THE USA

**PROUDLY DESIGNED, ENGINEERED
& ASSEMBLED IN THE USA**

When you buy HON office furniture, you're not just buying inspired, practical solutions — you're buying quality, American designed, engineered and assembled furniture backed by a lifetime warranty and a network of dealers.

LOOK FOR THIS ICON ON MODEL PAGES: 

HON FULL LIFETIME WARRANTY INFORMATION



FULL LIFETIME WARRANTY

YOUR HON FULL LIFETIME WARRANTY

Every time you purchase a HON product, you're making an investment in your future. We're proud to play a part in that future, and you can trust us to do our best for as long as you need us.

The HON Full Lifetime Warranty is our assurance to you that the HON desks, workstations, seating, tables, or storage you purchase will be free from defective material or workmanship for the life of the product.

In the unlikely event that any HON product or component covered by the HON Full Lifetime Warranty should fail under normal workplace use as a result of defective material or workmanship, HON promises to repair it. If we are unable to repair it, we will replace it with comparable product, or if preferred, we will refund the purchase price.

WHAT'S COVERED BY THE HON FULL LIFETIME WARRANTY?

Your HON Full Lifetime Warranty applies to product manufactured after January 1, 2011. All HON product lines, materials, and components are covered by the HON Full Lifetime Warranty except for the items described below.

The specific product lines, materials, and components listed below are covered under HON's Full 12-Year, Full 10-Year, and Full 5-Year Warranties (from date of purchase).

HON'S FULL 12-YEAR WARRANTY

- Electrical components (LED task lights, lamps and ballasts are not covered)
- ilira®-stretch
- Seating controls
- Pneumatic Cylinders
- Wood Seating
- Accessories
- Laminate Surfaces
- Veneer Surfaces

HON'S FULL 10-YEAR WARRANTY

- Soothe® Patient Recliner Mechanism
- Signal Seating Upholstery Fabric

HON'S FULL 5-YEAR WARRANTY

- All LED task lights
- Panel and seating textiles
- Electric Height-Adjustable Bases (Including Memory Control)
- Coordinate™ Desktop Sit-to-Stand Risers
- Soothe® Patient Recliner Central Lock Mechanism
- Soothe® Patient Recliner Pivoting Arm

These warranties apply to HON products sold within the United States of America, U.S. Territories, and Canada, as well as U.S. Military and Federal Agency purchases (regardless of location).

IS ANYTHING NOT COVERED?

There are a few exclusions to the HON Full Lifetime Warranty and to the 12-, 10-, and 5-year warranties. These exclusions are:

- All HON products that are covered under a separate 5-year warranty.
- Color-fastness or matching of colors, woodgrains, or textures occurring in wood, leather, or other materials that naturally exhibit inherent color variations.
- Customer's own materials (COM) selected by and used at the request of the user.
- Modifications or attachments to the product that are not approved by The HON Company and product failures resulting from such modifications or attachments.
- Product normal wear and tear, which are to be expected over the course of ownership.
- Products that were not installed, used, or maintained in accordance with product instructions and warnings.
- Products used for rental purposes.
- Damage caused by cleaning chemicals.
- Dye transfer caused by external contaminants (including clothing and accessory dyes such as those used on denim jeans) may migrate to lighter colors. This phenomenon is increased by humidity and temperature and is irreversible.
- Fabric pattern match seat to back or chair to chair. If pattern match is needed, please submit a Tailored Solutions request or contact HON Customer Support/Tailored Solutions with questions.

WARRANTY REQUESTS OR QUESTIONS?

Your HON Dealer is our mutual partner in supporting your warranty requests. To obtain service under this warranty, please contact your HON dealer. If you are not sure who your dealer is, please call HON Customer Support at 800.833.3964.

THAT'S YOUR HON FULL LIFETIME WARRANTY AS AN OWNER OF HON PRODUCT, THE WARRANTY EXPLAINED HERE IS YOUR SOLE AND EXCLUSIVE REMEDY. THERE ARE SOME EXCEPTIONS IF YOU PURCHASED THE PRODUCT FOR HOME OR PERSONAL USE WHICH ARE EXPLAINED BELOW. TO THE EXTENT ALLOWED BY LAW, THE HON COMPANY MAKES NO OTHER WARRANTY, EITHER EXPRESS OR IMPLIED, INCLUDING ANY WARRANTY OF MERCHANTABILITY OR FITNESS FOR A PARTICULAR PURPOSE. THE HON COMPANY WILL NOT BE LIABLE FOR ANY CONSEQUENTIAL OR INCIDENTAL DAMAGES.

A WORD ABOUT PURCHASES FOR HOME OR PERSONAL USE

Please note, this section only applies if you purchased your HON product for your home or for your own personal or family use. HON's warranties give you specific legal rights and you may have other rights, which vary from state to state. As a consumer purchaser, the complete exclusion of implied warranties noted in the above paragraph does not apply to you, however, to the extent allowed by applicable state law, the implied warranties are limited to the applicable term of the warranty. Some states do not allow the exclusion or limitation of incidental or consequential damages, so the above exclusion or limitation may not apply to you.

HON LIMITED 5-YEAR WARRANTY INFORMATION



LIMITED 5-YEAR WARRANTY

The HON Company promises to repair or replace HON products or components covered under this warranty that are found to be defective in material or workmanship within five (5) years from the date of original purchase so long as you, the original purchaser, still owns it. This is your sole and exclusive remedy. This warranty is subject to the provisions below. It applies to the products listed here manufactured after January 1, 2018.

LIMITATIONS:

- Upholstery on chairs is warranted for two years from date of purchase.
- Damage caused by the carrier in-transit is handled under separate terms.

EXCLUSIONS:

This warranty does not apply and no other warranty applies to:

- Normal wear and tear, which are to be expected over the course of ownership.
- Modifications or attachments to the product that are not approved by The HON Company.
- Products that were not installed, used or maintained in accordance with product instructions and warnings.
- Products used for rental purposes.

SEATING USAGE

Normal commercial use for seating is identified as the equivalent of a single shift, forty-(40) hour workweek. To the extent that a seating product is used in a manner exceeding this, the applicable warranty period will be reduced in a pro-rata manner.

A WORD ABOUT COLOR VARIATIONS, FABRICS AND FINISHES:

The HON Company does not warrant the color-fastness or matching of colors, grains or textures of covering materials.

CUSTOMER'S OWN MATERIAL (COM)

Not available on HON products covered under the HON 5-year warranty.

TO THE EXTENT ALLOWED BY LAW, THE HON COMPANY MAKES NO OTHER WARRANTY, EITHER EXPRESS OR IMPLIED, INCLUDING ANY WARRANTY OF MERCHANTABILITY OR FITNESS FOR A PARTICULAR PURPOSE. THE HON COMPANY WILL NOT BE LIABLE FOR ANY CONSEQUENTIAL OR INCIDENTAL DAMAGES.

NOTICE TO PURCHASERS FOR HOME OR PERSONAL USE:

Federal law does not permit the exclusion of certain implied warranties for consumer products. Therefore, if you are purchasing this product for home or personal use, the exclusion of implied warranties noted in the above paragraph does not apply to you. Some states do not allow the exclusion or limitation of incidental or consequential damages, so the above limitation or exclusion may not apply to you. This warranty gives you specific legal rights, and you may also have other rights which vary from state to state.

This warranty applies only to products sold within the United States of America and the Commonwealth of Canada.

TO OBTAIN SERVICE UNDER THIS WARRANTY:

Your HON® Dealer is our mutual partner in supporting your warranty requests. By following the procedures outlined below, you can be assured of the best level of service. Please note: Consent of The HON Company must be obtained before any warranty work is performed. To obtain consent, please take the following steps:

1. Contact the Dealer from whom the product was purchased within 30 days of discovery of the defect. Be prepared to affirm that you are the original purchaser of the product and to provide the serial number(s) from the product in question.
2. Your Dealer will gather all pertinent information regarding the claim, inspect the product and contact a HON Company customer service representative. (Please allow a reasonable amount of time for inspection and review.)
3. If The HON Company affirms that the product in question is eligible under the conditions of the warranty as stated above, the customer service representative or another representative of the Company will determine whether to provide replacement parts, authorize repairs or replace the product.

NOTES

ORDERING

Electronic ordering is the standard order process for HON. HON supports the following primary methods for the electronic transmission of orders and order related documents:

E-Ordering

Available in the HONReady portal at honready.hon.com. There are multiple options available for utilizing the E-Ordering application:

Integration with the standard Office Furniture business systems or other pre-approved proprietary software packages.

SIF file upload using fully optioned SIF files into the E-Ordering application.

Manual entry of line items into the E-Ordering application.

EDI-System to System Integration

With standard Office Product systems or other pre-approved proprietary software systems.

Training, technical set-up and support is available through our Customer Technology Services Team at honready@honcompany.com.

ORDER REQUIREMENTS

- Customer must provide complete and correct information, including complete model number, finishes, colors, options, and quantity.
- If a bid quotation or other special pricing applies, such information must be clearly stated on the order with applicable bid number or contract number.
- Order Management contact name and phone number.
- Delivery Appointment contact name and phone number at the dealership or installation company. HON does not accept orders with end user appointment contacts.
- Dealer Sales Representative, primary or multiple DSRs.
- “Best Date Available” for the entire order is standard service for HON. If eligible, other Date Requests may be requested and must be submitted with the order. Other Date Requests are subject to review by HON prior to acceptance:
 - “Ship After” requests are eligible on all order sizes
 - “Deliver On” requests are eligible for orders over \$140,000 list
- Additional services outside of HON’s standard services may be available through HON’s ‘Enhanced Services’ for a corresponding fee. Requested services from ‘Enhanced Services’ must be provided at time of order placement.
- The Company reserves the right to require electronic orders or charge \$50 fee per Purchase Order (PO) for manual order processing.
- Failure to provide complete and accurate information results in delayed order entry and acknowledgment. Incomplete orders will not be produced and will be returned to Dealer for correction.

ACKNOWLEDGMENT SERVICE

- E-mailed acknowledgments are available by customer request.
- An acknowledgment will be emailed the morning of the next business day, unless order is placed on credit or other order hold.
- The order will not receive an acknowledged shipment date until all order holds are released.

ORDER CHANGES OR CANCELLATIONS

For Order Changes or Cancellations, please contact Customer Support at 800-833-3964 or email OrderChanges@honcompany.com.

TERMS AND CONDITIONS

See **HON’s Express Overview Guide** on honready.hon.com for more information about HON Express delivery, services and ordering information.

See **HON NOW** on honready.hon.com for more information about HON NOW delivery, services and ordering information.

INTEGRATED DESIGN SOLUTIONS

HON INTEGRATED DESIGN SOLUTIONS

Need design assistance? We can help! Our expert design staff will create a professional design package that is sure to put you one step ahead of the competition. And the best part is – it's free*!

AUDIT

We will check your drawing and parts list for accuracy. We verify quantity, specification accuracy, product compatibility and structural support.

PLAN & SPECIFY

We will provide a professional design package including a CAD furniture plan, 3-D line drawing and complete parts list based on the rough sketch and work order forms you supply.

VALUE ENGINEERING

We will optimize workstation layouts and propose potential cost saving measures to help your customer save money and make you more competitive and profitable.

RENDERING

We will create a photo realistic rendering of your furniture plan to help your customer visualize what their desired office space will look like.

*SPACE PLANNING (BILLABLE SERVICE)

Let our team do the creative work for you. Our low rates and expert staff will create a furniture layout and design that best suits your customer.

PLANNING TYPICALS

Quick planning ideas to share with your clients. Various settings showcasing desks, tables and workstations available in multiple formats. View them today under Design Resources on the HON Ready Portal.

CONTACT INTEGRATED DESIGN SOLUTIONS

Questions? Please reach out to your region's dedicated design. Not sure how to reach your designer? Send us a note at the email below.

E-Mail: integrateddesign@honcompany.com



MyProjects

A place for all HON Project Services

MyProjects provides one platform to access the full portfolio of HON services including:

- Plan & Specify
- Audit
- Product Modification
- Special Laminates
- Value Engineering
- Rendering
- Customer's Own Material
- Dual Fabric Applications
- Space Planning
- Special Paints
- Project Bid Pricing

Submit your request on the HON Ready Portal at honready.hon.com, MyProjects.

MyProjects Lead Time: 1-3 business days depending on complexity and size of your project.

TAILORED SOLUTIONS ORDERING INFORMATION

PRODUCT MODIFICATIONS

Modifications include structural and dimensional modifications to existing product and Dual Fabric Applications, when standard model is not available.

The HON Company, at its own discretion, may modify standard products to meet specific needs. Product specials can be requested on HON brand product only; Product specials are not offered on *basyx* by HON® products.

List prices contained in published list pricers are for standard catalog items only. Changes or alterations to catalog items other than those listed as catalog options are subject to additional charges. Pricing will only be furnished upon approval of the special request.

Requests to have the product produced in more than one fabric (e.g., fabric on the seat is different than the fabric on the back), are considered a Dual Fabric Applications request and follow the Product Modification request process within MyProjects.

SPECIAL LAMINATES

Special laminates include requests for laminates not available as part of The HON Company's standard offering. Requests for special laminates are subject to manufacturing approval and minimum order quantities. The HON Company approved special laminates will be subject to a designated up-charge per unit.

Requests for special laminates should be submitted through the MyProjects Application on the HON Ready portal. Pricing will only be furnished upon approval of the special request.

SPECIAL PAINTS

- The HON Company's paint matching equipment can match almost any color, excluding some metallic and whites.
- Special paint requests must be submitted on the HON Ready Portal MyProjects application.
- In order to request a paint sample, the customer must have a minimum order of 10 like product units. Any requests with less than that amount will not be processed.
 - For each new paint request, there will be a \$500 net charge. A sample of the exact color desired is required for matching and approval. The exception to the sample requirement is if the customer provides a Sherwin Williams® or PANTONE® color code. The HON Company will match the color and provide a production sample for the customer to review and approve.
 - If the customer is requesting a paint that has been previously matched, a painted match sample is provided with a \$100 net charge.

- Once the signed paint sample is received at The HON Company, the request will be approved.
- Each unique color or finish combination incurs a designated up-charge per color per order. For pricing, see individual pricer pages for eligible series and up-charges for Custom paints (all standard discounts/competitive project pricing applies).

Special note: Some custom colors could fall outside of this program due to production costs or not meeting The HON Company's quality standards. This could include Sherwin Williams developed colorants. The HON Company may apply additional charges to some colors which are costly to apply, and refuse some orders on colors that cannot meet The HON Company's high quality standards. The HON Company will notify the customer upon completion of The HON Company's evaluation if a change in price is required or rejection of the order.

DISCONTINUED PRODUCT

Requests for discontinued product require engineering evaluation, safety review, and testing to current standards prior to approval. Many discontinued products are not available for order. Requests for discontinued products should be submitted through the MyProjects Application on the HON Ready portal.

LEAD TIMES FOR SPECIALS PRODUCT

Lead times on orders containing specials are subject to production capacity and material availability. When possible, the customer should order special products separately to avoid extended lead times for standard products. Extended lead times will be noted on the specials request.

CHANGES TO SPECIALS PRODUCT

A special model will be provided for each approved special item to process orders. Once an order is placed, no changes or cancellations can be made to the order without approval from Tailored Solutions.

CONTACT TAILORED SOLUTIONS

Phone: 800.833.3964 and listen for Tailored Solutions offering on the menu.

Email: HONSpecials@honcompany.com

CUSTOMER'S OWN MATERIAL ORDERING INFORMATION

CUSTOMER'S OWN MATERIAL (COM) PROGRAM

Customer's Own Material (COM) is a request to use fabrics not available as part of HON's standard fabric offering. Manufacture to Supply (MTS) and Dealer to Supply (DTS) are the two ordering methods. The HON Company has partnered with fabric manufacturers to provide competitive pricing and selection through the MTS program. MTS will be the standard offering unless The HON Company is unable to procure the fabric. If there is a DTS request submitted, The HON Company will advise at the time of the request if DTS is available.

CUSTOMER WARRANTY EXCLUSION

The HON Company shall have no responsibility for the condition, quality, value, performance, physical properties, or any other aspects of the COM.

The HON Company shall have no liability for any damages, injuries, or losses to the customer or to any third party that shall be caused by any COM or product modification, and the customer shall hold The HON Company harmless for all liability.

The HON Company assumes no responsibility for the overall appearance, flammability, normal durability, colorfastness, or any other quality of the COM or product modification after its application on a HON product beyond normal quality standards. The HON Company reserves the right to reject a COM fabric if the quality of the COM is not satisfactory for the product. Should this occur, the customer will be notified with an explanation of the issue.

The HON Company is not responsible for fabric that has become obsolete at the COM supplier, that is of poor quality, or that is delivered late to The HON Company from the COM supplier. The HON Company is not responsible for excess yardage created by DTS orders and reserves the right to dispose of the excess fabric.

As a standard HON does not pattern match any standard, partnership or COM fabric, therefore pattern match is not applicable under warranty. If pattern match is needed please submit a Tailored Solutions request or contact HON Customer Support/Tailored Solutions once your COM has been approved.

COM TESTING

As a result of recent legal requirements, The HON Company will need to obtain specific information from the fabric supplier about treatments and chemicals used in the fabric. To the extent the supplier is unwilling or unable to provide the necessary information, could extend the testing lead time of the request.

To check if a COM has been tested previously, utilize the COM Search Tool on the HON Ready Portal > Design Resources > Textiles & Finishes section using the following information:

- COM Supplier's Name
- Fabric Pattern Name
- Color Name
- If the COM fabric has been tested and previously approved, the COM will not need to be re-tested unless testing standards have changed, fabric is to be used on a different

series, or direction of the fabric has changed from what was previously approved. Please note that Panel product must be approved for each model and color.

- If the pattern has previously been tested and approved, but not in the specific requested color, the customer will need to request an order code for that color only. No further testing will be necessary since the pattern has already been approved.

If the fabric has not previously been tested, the customer must enter the COM request on the HON Ready Portal > Textiles & Finishes > COM Search Tool.

Your name, company name, and email will be prepopulated fields. The secondary email, project name, and bid/contract number are optional information. The supplier, pattern, and color will show a list by clicking in the box and entering the first letter of the name and these are free form text boxes. Once that information is entered click add. (Multiple series can be added to the same request if they are the same supplier, pattern, and color.) Then click submit.

An email will be sent to the requestor stating the COM Request was successfully submitted. Up to four emails could be received: submitted, testing materials requested, in testing, and final approval/denial with price grade and fabric code. The testing process takes approximately 48 hours.

COM yardage in the pricer is shown as pattern cut only.

COM TESTING — CAL 133 TESTING INFORMATION

The customer is responsible for ensuring that the COM fabric is certified to meet all flame-retardant requirements. All COM seating fabric must, at minimum, meet CAL 117 requirements. If the customer requires the chair be tested to meet the fire safety standards of CAL 133, additional testing and information is required.

All CAL 133 requests must be submitted through the MyProjects application on the HON Ready Portal. Each request must be entered separately since each request will need to be tested individually.

Once the supplier provides the required to The HON Company, testing will begin. The customer will receive approval or denial information upon completion of testing.

If the test is approved, a specific model number including "FC" at the end will be provided with an appropriate price.

MTS COM

As previously mentioned, MTS is the primary COM method.

If the COM fabric has not been tested, a COM request must be submitted on the HON Ready Portal.

For MTS orders, The HON Company will procure fabric needed for both testing and production phases. Should The HON Company not be able to obtain fabric yardage, the customer will be contacted.

CUSTOMER'S OWN MATERIAL ORDERING INFORMATION

When testing has been completed, the customer will be notified by the COM team of the test results. If the COM is approved, The HON Company will provide a COM tracking order code for MTS. That tracking code is required on the order in place of the standard fabric code.

If approved, MTS product will be assigned an appropriate fabric grade for pricing. The pricing can be found on the HON Ready Portal > Design Resources > Textiles & Finishes. (All standard discounts/competitive project pricing applies).

Written COM price quotes are valid for 90 days after the issue date.

DTS COM

DTS COM is only available if the COM fabric cannot be procured by The HON Company. If the fabric can be procured by The HON Company, the customer will be contacted to switch to MTS or cancel the request.

If your fabric is not listed as approved, and it is not a Partnership fabric you may request a "Dealer to Supply" code. Select the "Request COM Test" link on the COM Search website. Your name, company name, and email will be prepopulated fields. The secondary email, project name, and bid/contract number are optional information. The supplier, pattern, and color will show a list by clicking in the box and entering the first letter of the name and these are free form text boxes. Once that information is entered click add. (Multiple series can be added to the same request if they are the same supplier, pattern, and color.) Then click submit.

An email will be sent to the requestor stating the COM Request was successfully submitted. Up to four emails could be received: submitted, testing materials requested, in testing, and final approval/denial with price grade and fabric code. It's rare actual test yardage is required. Testing is mainly done by reviewing the attributes of the fabric. The testing process takes approximately 48 hours.

If the COM has not been tested, a COM request must be submitted on the HON Ready Portal > Design Resources > Textiles & Finishes.

When testing has been completed, the customer will be notified by the COM team of the test results. If the COM is approved, The HON Company will provide a COM tracking order code. That tracking code is required on the order in the place of the standard fabric code.

DTS product is priced at the following grades (all standard discounts/competitive project pricing applies):

- Chairs are a Grade 4
- Panel product is a Grade D

Written COM price quotes are valid for 90 days after the issue date.

COM LEAD TIME

Ship dates will be based on fabric receipt and The HON Company's standard lead time. All fabric must be properly tagged and shipped to the appropriate producing location (provided in the approval email).

- Specific to DTS orders, COM orders will not receive a ship (acknowledged) date until The HON Company has the fabric in its possession for production.
- Specific to DTS orders, the customer may send the required yardage for the order to the address listed on the approval email to arrive no sooner than 4 weeks in advance of the acknowledgment date.

HON will make every effort to locate mis-directed COM shipments on behalf of the customer. However, The HON Company will not be responsible for any COM received without a tracking number or incorrectly shipped by the fabric vendor to an incorrect producing facility.

COM ORDERING INFORMATION

The following information must appear on or accompany the product purchase order:

- Approval tracking number and the customer's purchase order number
- COM supplier, pattern, and color name/number
- Mark "Manufacture to Supply" or "Dealer to Supply"

The packing list for the COM must include the following information when The HON Company receives the shipment for production:

- Dealer or Wholesaler Name
- Purchase order number submitted to The HON Company
- Fabric name
- Yardage shipped
- Approval ordering code

If The HON Company receives fabric with incorrect labeling that cannot be linked to an order, The HON Company will hold the fabric for up to 7 days while the COM team attempts to identify the order. After 7 days, The HON Company will return the fabric to the sender.

Specific to DTS orders; the customer should send only the amount needed for the order. Excess yardage will be disposed of at The HON Company's discretion.

CHANGES TO COM PRODUCT

Once a COM product is ordered, no changes or cancellations can be made to the COM product without approval from the HON COM team.

CONTACT COM TEAM

Phone: 800.833.3964 and listen for COM TEAM offering on the menu.

COM Email: HONCOMTeam@honcompany.com

PARTNERSHIP TEXTILE INFORMATION

Partnership Textiles is the result of The HON Company's partnership with textile industry leaders Camira, Maharam, Stinson, and Ultrafabrics, LLC. The extensive collection of design-driven textiles create a superior offering at a great value. Partnership Textiles significantly updates HON's offering, expanding it with fresh and exciting options.

- Fabric Warranty: Partnership Textiles are covered by HON's Full Lifetime Warranty.
- Lead Times: Orders specified with Partnership Textiles will be acknowledged based on the supplier's availability and delivery schedule.
- Availability: The HON Company will regularly introduce new Partnership Textiles and reserves the right to change the offering at any time.
- Fabric Cards: A curated set of Partnership Textiles are carded jointly by HON and the supplier.

Camira

- Blazer

Maharam

- Lariat
- Manner, Medium, Messenger, Metric
- Value Reference 5

Stinson

- Edge
- Flow
- Habitation
- Reliance III
- Square One

Ultrafabrics, LLC

- Brisa
- Ultraleather Pro
- Fabric Memo Samples: Please contact the supplier directly:
Maharam: (800) 645-3943
Stinson: (800) 841-6279
Ultrafabrics: (877) 309-6648

HON BRANDED, PARTNERSHIP AND COM PATTERN MATCH

- Seat to Back Pattern Match provides alignment of patterns or stripes on chair front surfaces. Additional yardage may be required depending on pattern repeat. If Seat to Back Pattern Match is needed, please contact HON Customer Support/Tailored Solutions. Upcharges are limited to the following product series: Endorse® Lounge Seating, Flock® Collaborative Seating, Grove® Seating, Invitation® Lounge Seating, Soothe® Seating.

| | |
|------------------|---------------------------|
| Single Chair | \$45.00 ea. list upcharge |
| Two-seat Chair | \$60.00 ea. list upcharge |
| Three-seat Chair | \$75.00 ea. list upcharge |
- Chair to Chair Pattern Match provides identical pattern alignment from unit to unit and is available with an upcharge. Chair to Chair Pattern Match is reviewed on a case by case basis as several factors are reviewed to determine additional yardage required, including repeat and pattern direction. If Chair to Chair Pattern Match is needed, please contact HON Customer Support/Tailored Solutions.



ENVIRONMENTAL STATEMENT

Clearing the air.

In 2006, The HON Company became the world's first office furniture manufacturer to have products certified under the Indoor Advantage™ program. Virtually all manufactured products emit chemical compounds into the air. Indoor Advantage™ certification helps assure customers that certified products will help improve the air quality within their offices and workspaces.

Developed by SCS Global Services, Indoor Advantage™ evaluates products against indoor air quality standards, like ANSI/BIFMA Furniture Emissions Standard, X7.1. The ANSI/BIFMA X7.1 standard allows manufacturers to test individual components, as well as complete products for emissions from volatile organic compounds (VOCs). This allows us to identify problematic materials and phase them out of our products.

Indoor Advantage™ certified products meet the LEED v4 credits for low-emitting materials.

Indoor Advantage™ offers two levels of certification:



On the level®.

level®, the BIFMA e3 Sustainability Standard, was developed in response to increasing demand for proof that manufacturers were living up to their environmental claims. level® is a multi-attribute sustainability certification label for products that have met criteria in four categories of impact: Materials, Energy and Atmosphere, Human and Ecosystem Health, and Social Responsibility.

level® offers three levels of certification:



Products that meet these specifications are identified throughout this publication with the following icons:

Certified SCS Indoor Advantage™



level® certified to the BIFMA e3 Sustainability Standard



IMPORTANT INFORMATION

HON. EXPRESS

- Simple
- Affordable
- Fast
- Easy

Your go-to for office furniture delivered fast at an affordable price. Simple to sell and easy to assemble. Add the confidence you'll receive from our industry-leading warranties all **delivered in 5 business days or less.**

HON NOW™

NOW THAT'S FAST

Getting your business up and running fast with HON NOW. Easy to plan, order and install. It's your workstation, your way. Providing small project solutions delivered in 5 days or less.

GSA CONTRACT INFORMATION

Model numbers identified with the verbiage "**Open Market**" are not offered on HON's GSA contract GS-27F-0015S. Model numbers identified with the following verbiage "Must be purchased with a configurable end product. If ordered separately, not on GSA contract" is to mean that these configurable components or options:

- Have no functionality or capability without being integrated into an end product, and
- Are not separately orderable; an eligible Schedule ordering activity may only purchase them with a configured system that is on contract.

HON CUSTOMER SUPPORT CONTACT INFORMATION

Nationwide CS Phone – (800) 833-3964

Nationwide Product Solutions Team/Phone – (800) 336-8398

Nationwide Order Entry – email: HONOE@honcompany.com

HON Express – email: HONOE@honcompany.com
(subject line: Express Order)

Government CS Phone – (800) 466-8694

GSA Team: HONGSATEAM@honcompany.com

GSA Order Entry: HONGSAOE@honcompany.com

Integrated Design Solutions – (800) 433-7264

HON Online Order Support – HONReady@honcompany.com

DASH (transportation and delivery assistance) – (800) 334-8057

HON Literature Fulfillment Phone – (800) 466-4808

HON Literature Fulfillment Fax – (800) 466-1865



Nationwide CS Phone
800-833-3964

THE FOLLOWING ICONS ARE USED THROUGHOUT THIS PUBLICATION

- 

Meets or exceeds ANSI/BIFMA and ISTA performance standards
- 

Certified SCS Indoor Advantage™
See page 15 for more details.
- 

Complies to the BIFMA e3 Sustainability Standard.
See page 15 for more details.
- 

Caution
- 

Easy to assemble
- 

Shippable by small-package carrier
- 

Wheel-chair compatible
- 

Soft-tread caster option available
- 

Readily Available. For additional lead time information see page 21.
- 

Available within a “standard” or “extended” lead time. For additional lead time information see page 21.
- 

May have extended lead times. For additional lead time information see page 21.
- 

Product shipped two to a carton
- 

Product shipped four to a carton
- 

Fire Code
- 

Core Product Line
- 

ColorCorrect® Eligible Product
- 

Product scheduled for discontinuation
- 

DE-EMPHASIZED: Product or fabric/surface material is de-emphasized, effective date as noted. Not carded. View online at honready.hon.com
- 

Proudly Made in the USA. See page 5 for more details.
- 

Proudly Designed, Engineered & Assembled in the USA. See page 5 for more details.
- 

Warranted for multiple shift use, 24 hours a day 7 days a week

SEATING FUNCTIONS

Work/task chairs need to be adjusted to deliver optimum support. Cross-reference the letter key below to identify the chairs in this section that best meet your needs.

PROPORTIONAL ADJUSTMENTS

These controls adapt the dimensions of the chair to fit the user.



A. Pneumatic seat height adjustment — Regulates height of chair relative to floor.

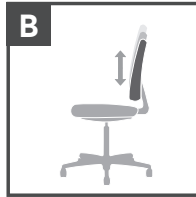

B. Back height adjustment — Positions lumbar support within a fixed range.

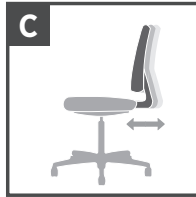

C. Seat depth adjustment — Positions chair back relative to seat.

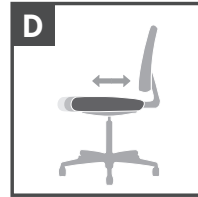

D. Seat slide mechanism — Seat cushion travels forward and back, then locks into position.

ARM OPTIONS

These adjustments accommodate different sized users and support keyboarding.



Q. Adjustable height arms — Provide improved upper-torso support. Can be adjusted periodically to relieve strain and provide variety.

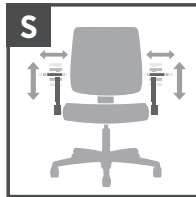

S. Height and width adjustable arms — Controls both height and width of arms for optimum comfort.



T. Loop arms — Largely specified for aesthetics. Frequently used in management settings.

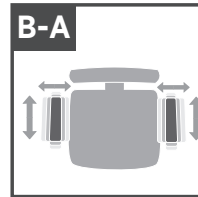

B-A. All-adjustable arms — Arms adjust in height, width, and depth.

SEATING FUNCTIONS

POSTURE CONTROLS

The controls modify the position and angle of the seat and back to respond to changing tasks.



E. 360° Swivel

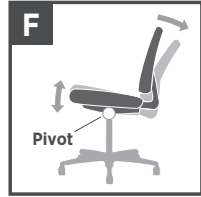

F. Tilt — Pivot point located directly above center of chair base.

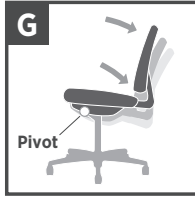

G. Mid-range knee tilt — Pivot point located slightly ahead of center of chair base. Allows user to recline at a slightly more relaxed angle than conventional tilt.

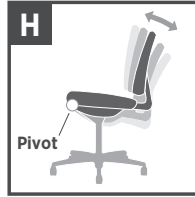

H. Knee tilt — Pivot point located near front edge of chair. Allows user to keep feet flat on floor while chair reclines.

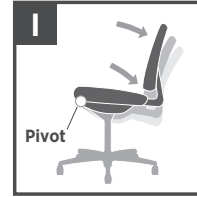

I. Synchronized knee tilt — Back reclines at a 2-to-1 ratio to seat angle. Pivot point located near front edge of chair.

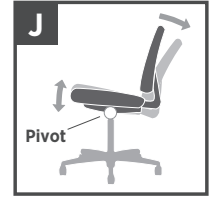

J. Synchro-tilt — Back reclines at a 2-to-1 ratio to seat angle. Allows user to recline while keeping seat cushion relatively level to floor.



K. Tilt tension — Controls rate and ease of recline.



L. Tilt lock — Locks out tilt function when chair is in upright position.



M. Posture mechanism/lock — Back angle adjusts independently of seat, and can be locked in an infinite number of positions within a fixed range.



N. Multi-task control — Adjusts seat and back angles independently with a single lever (infinite locking within a fixed range).



O. Asynchronous control — High performance system with three levers to modify: angle of back relative to seat, tilt (free float or infinite locking) and forward tilt.



W. Integral lumbar support — Easily adjusts to enhance comfort.



X. Dual-clutch posture control — Adjusts seat and back angles independently with two levers (infinite locking within a fixed range).

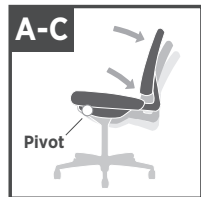

A-C. Synchronized tilt — Back reclines at a 2.5 to 1 ratio to seat angle. Variable lock.



A-D. Side tilt tension — Controls rate and ease of recline. Conveniently located on the right side.



A-E. Back reclines at a 2 to 1 ratio to seat angle. Back angle adjusts independently of seat and can be locked in infinite number of positions within a fixed range.

FABRIC PATTERNS & CODES



FABRIC PATTERNS & CODES

- For additional HON to Supply COM fabric grade pricing, go to honready.hon.com and search on the HON to Supply COM link.
- All specifications in this publication are based on the latest product information available at the time of print.
- Certain dyes (including clothing and accessory dyes such as those used on denim jeans) may migrate to lighter colors. This phenomenon is increased by humidity and temperature and is irreversible. The HON Company LLC does not assume responsibility for dye transfer caused by external contaminants.
- COM Ordering Information and pricing on page 13.
- See page 14 for Partnership Textile program information.
- All standard fabrics are carded. Cards are available through HON Literature Fulfillment.
- Remember to add an FC to the base model number when fire code fabric is selected. New Models with FC Fire Code suffix meet CA Technical Bulletin 133. See pages 28-31 for available models/fabrics.
- Fabrics and foam meet requirements for CAL-TB 117-2013.
- Fire Code fabrics with FC foam meet requirements for CA Technical Bulletin 133.

LEAD TIMES

THE FOLLOWING ICONS ARE USED TO DENOTE FABRIC OPTION LEAD TIMES

FABRIC/FINISH LEAD TIME INDICATOR



Fabric is readily available. Products using these fabrics will receive the best available product lead time and are a good option for standards programs as they will be in the HON portfolio for several years. Go to honready.hon.com and search “lead time” for product lead times by series.



Fabric is available within standard lead times. Products using these fabrics will receive a “standard” or “extended” lead time. The lead time will be determined by the combination of product and fabric. Go to honready.hon.com and search “lead time” for product lead times by series.



Fabric may have extended lead times. Products using these fabrics will typically have a 4+ week lead time. Go to honready.hon.com and search “lead time” for product lead times by series.

HON EXPRESS QUICK SHIP PROGRAM

For the full list of products delivered in 5 business days or less, visit honready.hon.com.

PRODUCT LEAD TIMES

Standard lead times for products are between 2-4 weeks. For current exceptions to our standard lead time, go to the honready.hon.com and search “lead time.”

In order to establish accurate expectations for your project, please review this listing prior to submitting your purchase order.

Lead time calculation begins when order is free from any holds (i.e., bad lines, material, credit, etc.).

Please note, these production lead time estimates do NOT include delivery time. All published lead times are estimates, not guarantees of delivery.

For further information concerning lead times, please contact HON Customer Support via email HONTeamBox@honcompany or by phone at **800-833-3964**.

FABRIC PATTERNS & CODES

GRADE 1

| ATTIRE | AI |
|---------------|------|
| ◆ Blaze | AI42 |
| ◆ Blue Lagoon | AI90 |
| ◆ Crimson | AI62 |
| ◆ Fatigue | AI76 |
| ◆ Ivy | AI82 |
| ◆ Lithium | AI19 |
| ◆ Onyx | AI10 |
| ◆ Sable | AI49 |
| ◆ Taupe | AI26 |
| ◆ Turquoise | AI96 |

BLACK FABRIC ACCF

| | |
|---------|--------|
| ◆ Black | ACCF10 |
|---------|--------|

BLACK MESH ACCM

| | |
|---------|--------|
| ◆ Black | ACCM10 |
|---------|--------|

CENTURION CU

| | |
|-------------|------|
| ◆ Apricot | CU47 |
| ◆ Bark | CU25 |
| ◆ Black | CU10 |
| ◆ Espresso | CU49 |
| ◆ Fog | CU03 |
| ◆ Frost | CU22 |
| ◆ Goldenrod | CU27 |
| ◆ Indigo | CU06 |
| ◆ Iris | CU50 |
| ◆ Iron Ore | CU19 |
| ◆ Jade | CU83 |
| ◆ Marsala | CU63 |
| ◆ Morel | CU24 |
| ◆ Navy | CU98 |
| ◆ Peacock | CU97 |
| ◆ Pear | CU84 |
| ◆ Ruby | CU67 |
| ◆ Sapphire | CU09 |

COMPASS COMP

| | |
|---------------|--------|
| ◆ Beach | COMP16 |
| ◆ Bittersweet | COMP46 |
| ◆ Chocolate | COMP49 |
| ◆ Ink | COMP10 |
| ◆ Meadow | COMP82 |
| ◆ Midnight | COMP90 |
| ◆ Putty | COMP22 |
| ◆ Ruby | COMP62 |
| ◆ Sterling | COMP19 |
| ◆ Taupe | COMP26 |
| ◆ Tide | COMP96 |

GRADE 1 *continued*

| COMPASS FOAM* | COMF |
|---------------|--------|
| ◆ Bittersweet | COMF46 |
| ◆ Ink | COMF10 |
| ◆ Meadow | COMF82 |
| ◆ Midnight | COMF90 |
| ◆ Putty | COMF22 |
| ◆ Sterling | COMF19 |

**This fabric available for Solve* Upholstered Back models only.*

CONTOURETTE POLYURETHANE UR

| | |
|---------------|------|
| ◆ Baltic | UR94 |
| ◆ Beach | UR23 |
| ◆ Black | UR10 |
| ◆ Bordeaux | UR63 |
| ◆ Buff | UR22 |
| ◆ Cloud | UR18 |
| ◆ Coffee Bean | UR49 |
| ◆ Crater | UR51 |
| ◆ Flame | UR62 |
| ◆ Graphite | UR19 |
| ◆ Iron | UR20 |
| ◆ Luggage | UR26 |
| ◆ Marine | UR92 |
| ◆ Navy | UR95 |
| ◆ Nimbus | UR93 |
| ◆ Ocean | UR96 |
| ◆ Pumpkin | UR42 |
| ◆ Quarry | UR24 |
| ◆ Red | UR64 |
| ◆ Safari | UR27 |
| ◆ Sage | UR82 |
| ◆ Steel | UR21 |
| ◆ Storm | UR17 |
| ◆ Taupe | UR28 |
| ◆ Trunk | UR50 |

GRADE 1 *continued*

| DAPPER | DAPR |
|------------|--------|
| ◆ Ash | DAPR20 |
| ◆ Azalea | DAPR95 |
| ◆ Breeze | DAPR06 |
| ◆ Canvas | DAPR25 |
| ◆ Currant | DAPR00 |
| ◆ Emerald | DAPR75 |
| ◆ Fawn | DAPR35 |
| ◆ Fern | DAPR85 |
| ◆ Jewel | DAPR08 |
| ◆ Marigold | DAPR65 |
| ◆ Onyx | DAPR10 |
| ◆ Orchid | DAPR90 |
| ◆ Peony | DAPR50 |
| ◆ Pool | DAPR05 |
| ◆ Rose | DAPR40 |
| ◆ Sapphire | DAPR07 |
| ◆ Scarlet | DAPR45 |
| ◆ Sepia | DAPR30 |
| ◆ Slate | DAPR15 |
| ◆ Sorbet | DAPR55 |
| ◆ Spice | DAPR60 |
| ◆ Spring | DAPR80 |
| ◆ Varsity | DAPR09 |
| ◆ Zest | DAPR70 |

HAMILTON HAML

| | |
|-----------------|--------|
| ◆ Azure | HAML10 |
| ◆ Biscotti | HAML11 |
| ◆ Cabernet | HAML08 |
| ◆ Carolina | HAML21 |
| ◆ Charcoal | HAML17 |
| ◆ Chocolate | HAML13 |
| ◆ Cloud | HAML18 |
| ◆ Dane | HAML16 |
| ◆ Dusty Rose | HAML07 |
| ◆ Esmeralda | HAML06 |
| ◆ Fern | HAML04 |
| ◆ Fresh | HAML03 |
| ◆ Granola | HAML19 |
| ◆ Lilac | HAML14 |
| ◆ Lime | HAML05 |
| ◆ Lipstick | HAML09 |
| ◆ Oxford | HAML20 |
| ◆ Passion Fruit | HAML02 |
| ◆ Pepper | HAML15 |
| ◆ Powder | HAML12 |
| ◆ Sunrise | HAML01 |

GRADE 1 *continued*

| INERTIA | NR |
|------------|------|
| ◆ Amethyst | NR61 |
| ◆ Bronze | NR28 |
| ◆ Calypso | NR98 |
| ◆ Cherry | NR66 |
| ◆ Clover | NR74 |
| ◆ Cobalt | NR91 |
| ◆ Coffee | NR49 |
| ◆ Fog | NR19 |
| ◆ Fuchsia | NR63 |
| ◆ Gecko | NR76 |
| ◆ Glow | NR27 |
| ◆ Leaf | NR75 |
| ◆ Lime | NR82 |
| ◆ Loft | NR22 |
| ◆ Mandarin | NR47 |
| ◆ Meteor | NR30 |
| ◆ Mulberry | NR60 |
| ◆ Mustard | NR26 |
| ◆ Nickel | NR23 |
| ◆ Onyx | NR10 |
| ◆ Regatta | NR90 |
| ◆ Shadow | NR20 |
| ◆ Surf | NR96 |
| ◆ Tangelo | NR46 |

OPTIC OP

| | |
|----------------|------|
| ◆ Aurora | OP72 |
| ◆ Bark | OP24 |
| ◆ Canopy | OP84 |
| ◆ Char | OP49 |
| ◆ Dune * | OP16 |
| ◆ Forest * | OP82 |
| ◆ Ruby | OP42 |
| ◆ Sand | OP17 |
| ◆ Sky | OP83 |
| ◆ Slate | OP19 |
| ◆ Sprout | OP74 |
| ◆ Starry Night | OP11 |
| ◆ Storm | OP56 |
| ◆ Wildfire | OP66 |

* Fabric is de-emphasized.

FABRIC PATTERNS & CODES

GRADE 2

| APPOINT SEATING | PNS |
|-----------------|--------|
| ◆ Blackberry | PNS012 |
| ◆ Bronze | PNS002 |
| ◆ Carbon | PNS008 |
| ◆ Cherry | PNS010 |
| ◆ Espresso | PNS003 |
| ◆ Framboise | PNS011 |
| ◆ Jet | PNS007 |
| ◆ Lawn | PNS005 |
| ◆ Mandarin | PNS009 |
| ◆ Morel | PNS001 |
| ◆ Platinum | PNS004 |
| ◆ Turquoise | PNS006 |

| CLYDE | CLYD |
|--------------|--------|
| ◆ Antique | CLYD04 |
| ◆ Artifact | CLYD01 |
| ◆ Blacksmith | CLYD10 |
| ◆ Claret | CLYD13 |
| ◆ Craftsman | CLYD08 |
| ◆ Crate | CLYD12 |
| ◆ Fossil | CLYD02 |
| ◆ Heirloom | CLYD05 |
| ◆ Iron | CLYD11 |
| ◆ Linen | CLYD14 |
| ◆ Relic | CLYD06 |
| ◆ Seasoned | CLYD03 |
| ◆ Trestle | CLYD07 |
| ◆ Weathered | CLYD09 |

| DOTTY | DOT |
|-------------|-------|
| ◆ Berry | DOT62 |
| ◆ Black | DOT10 |
| ◆ Candy | DOT63 |
| ◆ Crimini | DOT28 |
| ◆ Gelato | DOT34 |
| ◆ Indigo | DOT31 |
| ◆ Mosaic | DOT26 |
| ◆ Onyx | DOT35 |
| ◆ Park | DOT83 |
| ◆ Peat | DOT24 |
| ◆ Peony | DOT32 |
| ◆ Pewter | DOT19 |
| ◆ Sepia | DOT49 |
| ◆ Suit | DOT20 |
| ◆ Sunflower | DOT33 |
| ◆ Tailor | DOT21 |
| ◆ Tide | DOT90 |
| ◆ Toffee | DOT76 |
| ◆ Tomatillo | DOT82 |
| ◆ Velum | DOT29 |
| ◆ Violet | DOT30 |

GRADE 2 *continued*

| RUSH | RUSH |
|-------------|--------|
| ◆ Anchor | RUSH07 |
| ◆ Basil | RUSH16 |
| ◆ Blueberry | RUSH10 |
| ◆ Flamingo | RUSH21 |
| ◆ Greenery | RUSH15 |
| ◆ Greyhound | RUSH06 |
| ◆ Marina | RUSH13 |
| ◆ Merlot | RUSH19 |
| ◆ Midnight | RUSH11 |
| ◆ Mint | RUSH09 |
| ◆ Mulberry | RUSH18 |
| ◆ Pumice | RUSH01 |
| ◆ Punch | RUSH20 |
| ◆ Sage | RUSH14 |
| ◆ Salsa | RUSH24 |
| ◆ Sand | RUSH05 |
| ◆ Seal | RUSH08 |
| ◆ Soot | RUSH02 |
| ◆ Stout | RUSH03 |
| ◆ Sunshine | RUSH23 |
| ◆ Tapestry | RUSH04 |
| ◆ Tiger | RUSH22 |
| ◆ Vintage | RUSH17 |
| ◆ Wave | RUSH12 |

| SEED | SED |
|-------------|-------|
| ◆ Apple | SED11 |
| ◆ Ash | SED15 |
| ◆ Cardinal | SED09 |
| ◆ Cinder | SED17 |
| ◆ Cream | SED12 |
| ◆ Driftwood | SED13 |
| ◆ Harbor | SED10 |
| ◆ Onyx | SED18 |
| ◆ Smoke | SED16 |
| ◆ Truffle | SED14 |

| SPIN SEATING | SPNN |
|---------------|--------|
| ◆ Alabaster | SPNN02 |
| ◆ Cavern | SPNN03 |
| ◆ Cobblestone | SPNN04 |
| ◆ Ember | SPNN06 |
| ◆ Flame | SPNN07 |
| ◆ Heron | SPNN13 |
| ◆ Oat | SPNN01 |
| ◆ Ocean | SPNN12 |
| ◆ Plum | SPNN15 |
| ◆ Pool | SPNN11 |
| ◆ Raven | SPNN10 |
| ◆ Rhubarb | SPNN14 |
| ◆ Tropic | SPNN08 |
| ◆ Willow | SPNN05 |

GRADE 2 *continued*

| WHISPER VINYL | WP |
|---------------|-------|
| ◆ Antelope | WP20 |
| ◆ Black | WP40 |
| ◆ Bone | WP17 |
| ◆ Bordeaux | WP26 |
| ◆ Brick Red | WP99 |
| ◆ Camel | WP18 |
| ◆ Cappuccino | WP21 |
| ◆ Carotene | WP97 |
| ◆ Cashew | WP29 |
| ◆ Cerulean | WP36 |
| ◆ Charcoal | WP39 |
| ◆ Cinnamon | WP25 |
| ◆ Cognac | WP62 |
| ◆ Cucumber | WP88 |
| ◆ Elephant | WP38 |
| ◆ Espresso | WP49 |
| ◆ Fawn | WP91 |
| ◆ Fog | WP100 |
| ◆ Forest | WP82 |
| ◆ Gravel | WP19 |
| ◆ Indigo | WP86 |
| ◆ Luggage | WP23 |
| ◆ Mahogany | WP93 |
| ◆ Mallard | WP90 |
| ◆ Merlot | WP27 |
| ◆ Molten | WP98 |
| ◆ Navy | WP37 |
| ◆ Ochre | WP96 |
| ◆ Paradise | WP85 |
| ◆ Patina | WP34 |
| ◆ Pewter | WP83 |
| ◆ Putty | WP84 |
| ◆ Salsa | WP42 |
| ◆ Sangre | WP28 |
| ◆ Sassafras | WP89 |
| ◆ Storm | WP92 |
| ◆ Truffle | WP95 |
| ◆ Zest | WP87 |

GRADE 3

| IN SEASON | ISN |
|-------------|--------|
| ◆ Black | ISN001 |
| ◆ Blue Jay | ISN007 |
| ◆ Fire | ISN004 |
| ◆ Jungle | ISN008 |
| ◆ Lake | ISN006 |
| ◆ Lead | ISN002 |
| ◆ Limestone | ISN041 |
| ◆ Ocean | ISN005 |
| ◆ Silver | ISN003 |
| ◆ Smoke | ISN020 |
| ◆ Tundra | ISN011 |

| PURL | PURL |
|------------|--------|
| ◆ Alpaca | PURL08 |
| ◆ Braid | PURL10 |
| ◆ Deep | PURL12 |
| ◆ Graze | PURL05 |
| ◆ Loom | PURL06 |
| ◆ Needle | PURL07 |
| ◆ Pasture | PURL02 |
| ◆ Ranch | PURL04 |
| ◆ Shuttle | PURL09 |
| ◆ Skein | PURL01 |
| ◆ Thistle | PURL11 |
| ◆ Yearling | PURL03 |

FABRIC PATTERNS & CODES

GRADE 3

continued

| SILVERTEX™ VINYL | SX |
|-------------------|------|
| ◆ Acid | SX34 |
| ◆ Basil | SX20 |
| ◆ Bazaar | SX37 |
| ◆ Blackberry | SX17 |
| ◆ Borscht | SX15 |
| ◆ Bottle | SX21 |
| ◆ Bronze | SX32 |
| ◆ Carbon | SX23 |
| ◆ Celery | SX19 |
| ◆ Champagne | SX08 |
| ◆ Chestnut | SX10 |
| ◆ Cream | SX07 |
| ◆ Crème de Menthe | SX33 |
| ◆ Ice | SX06 |
| ◆ Imperial | SX38 |
| ◆ Jet | SX05 |
| ◆ Lagoon | SX02 |
| ◆ Limoncello | SX42 |
| ◆ Luggage | SX13 |
| ◆ Mandarin | SX11 |
| ◆ Marine Blue | SX01 |
| ◆ Marsh | SX31 |
| ◆ Meteor | SX24 |
| ◆ Mocha | SX25 |
| ◆ Neutra | SX30 |
| ◆ Peat | SX35 |
| ◆ Plata | SX39 |
| ◆ Poppy | SX12 |
| ◆ Raspberry | SX16 |
| ◆ Sage | SX18 |
| ◆ Sapphire | SX04 |
| ◆ Sterling | SX40 |
| ◆ Storm | SX22 |
| ◆ Taupe | SX09 |
| ◆ Turquoise | SX03 |
| ◆ Umber | SX14 |
| ◆ Zest | SX41 |

GRADE L

| DENVER LEATHER | SS |
|----------------|------|
| ◆ Black | SS11 |
| ◆ Brick | SS62 |
| ◆ Chocolate | SS49 |

For a complete list of fabrics, including partnership fabrics, go to hon.com/fabricsandfinishes.

ORDERING INFORMATION

| Steel Seating | Standard Fabric Selections by Series with Price Code and Fabric Material | | | | | | | | | | | | | | | | | | | | | | | | |
|--|--|------------------------|--|-------------------------------|----------------------------|-------------|-----------|---------|--------------|--------------------------|--------|----------|---------|-------|-----------------|-------|------|------|------|--------------|---------------|-----------|------|------------------|-------------------|
| | 1 | 1 | 1 | 1 | 1 | 1 | 1 | 1 | 1 | 1 | 1 | 1 | 1 | 1 | 2 | 2 | 2 | 2 | 2 | 2 | 2 | 3 | 3 | 3 | L |
| Model/Series | AI | EB | VA | GA | MM | EA | CU | COMP | COMF | UR | DAPR | HAML | NR | OP | PNS | CLYD | DOT | RUSH | SED | SPNN | WP | ISN | PURL | SX | SS |
| | Attire | Black & Burgundy Vinyl | Black, Charcoal, Burgundy, & Navy Fabric | Black, Crimson, & Navy Fabric | Black Sandwich Mesh Fabric | Black Vinyl | Centurion | Compass | Compass Foam | Contourette Polyurethane | Dapper | Hamilton | Inertia | Optic | Appoint Seating | Clyde | Doty | Rush | Seed | Spin Seating | Whisper Vinyl | In Season | Purl | Silvertex™ Vinyl | Denver Leather |
| Accommodate® | • | | | | | | • | • | | • | • | • | • | • | • | • | • | • | • | • | • | • | • | • | • |
| Adjustable Task/Lab Stool | | | | | | • | | | | | | | | | | | | | | | | | | | |
| Boda™ | | | | | • | | | | | | | | | | | | | | | | | | | | |
| Ceres® Series | • | | | | | | • | • | | • | • | • | • | • | • | • | • | • | • | • | • | • | • | • | • |
| ComforTask® 5900 Series | • | | | | | | | • | • | | • | • | • | • | • | • | • | • | • | • | • | • | • | • | • |
| Convergence® | • | | | | | | | • | • | | • | • | • | • | • | • | • | • | • | • | • | • | • | • | • |
| Endorse® Lounge | • | | | | | | | • | • | | • | • | • | • | • | • | • | • | • | • | • | • | • | • | • |
| Endorse® Task | • | | | | | | | • | • | | • | • | • | • | • | • | • | • | • | • | • | • | • | • | • |
| Flock®* | • | | | | | | | • | • | | • | • | • | • | • | • | • | • | • | • | • | • | • | • | • |
| Flock® Round Lounge HFLRC1/DF and Stool HFSS7 | | | | | | | | • | • | | • | • | • | • | • | • | • | • | • | • | • | • | • | • | • |
| Gamut® 2070 Series | | | | | | | | • | • | | • | • | • | • | • | • | • | • | • | • | • | • | • | • | • |
| Grove® | | | | | | | | • | • | | • | • | • | • | • | • | • | • | • | • | • | • | • | • | • |
| Ignition® Series | • | | | | | | | • | • | | • | • | • | • | • | • | • | • | • | • | • | • | • | • | • (Black Only) |
| Invitation® Lounge Series | • | | | | | | | • | • | | • | • | • | • | • | • | • | • | • | • | • | • | • | • | • |
| Lota® H2281 / H2283 / H2285 | | | • | | | | | | | | | | | | | | | | | | | | | | |
| Lota® H2282 / H2284 | • | | | | | | | • | • | | • | • | • | • | • | • | • | • | • | • | • | • | • | • | • |
| Motivate® | • | | | | | | | • | • | | • | • | • | • | • | • | • | • | • | • | • | • | • | • | • |
| Nucleus® Series | • | | | | | | | • | • | | • | • | • | • | • | • | • | • | • | • | • | • | • | • | • |
| Pagoda® 4070/4090 Series** | • | | | | | | | • | • | | • | • | • | • | • | • | • | • | • | • | • | • | • | • | • |
| Park Avenue Collection® 5020 Series | • | | | | | | | • | • | | • | • | • | • | • | • | • | • | • | • | • | • | • | • | • |
| Perpetual® Nesting | • | | | | | | | • | • | | • | • | • | • | • | • | • | • | • | • | • | • | • | • | • |
| Pillow-Soft® 2090 Series | | • | | | | | | • | • | | • | • | • | • | • | • | • | • | • | • | • | • | • | • | • |
| Purpose® | | | | | | | | • | • | | • | • | • | • | • | • | • | • | • | • | • | • | • | • | • |
| Quotient® | • | | | | | | | • | • | | • | • | • | • | • | • | • | • | • | • | • | • | • | • | • |
| Solutions Seating® 4000 Series | • | | | | | | | • | • | | • | • | • | • | • | • | • | • | • | • | • | • | • | • | • |
| Solve® | • | | | | | | | • | • | • | • | • | • | • | • | • | • | • | • | • | • | • | • | • | • (Seat Only) |
| Soothe® | • | | | | | | | • | • | | • | • | • | • | • | • | • | • | • | • | • | • | • | • | • |
| Soothe® High Back & Recliner | | | | | | | | | | | | | | | | | | | | | | | | | |
| Volt® 5700/5710 Series | | | | • | | | | | | | | | | | | | | | | | | | | | |
| Volt® 5720/5730 Series | • | | | | | | | • | • | | • | • | • | • | • | • | • | • | • | • | • | • | • | • | • |
| 7800 Series | • | | | | | | | • | • | | • | • | • | • | • | • | • | • | • | • | • | • | • | • | • |
| Credenza/Pedestal Cushions | • | | | | | | | • | • | | • | • | • | • | • | • | • | • | • | • | • | • | • | • | • |

*Flock® chair model HFLRC1 has fabric limitations, please see the Flock® seating pages 92-101 for details.

**Pagoda® wood back models available in Harvest (C), Natural Maple (D), Shaker Cherry (F), Bourbon Cherry (H) and Mahogany (N) only.

ORDERING INFORMATION

- Seating pages are now arranged in alpha, then numeric, order.
- **All specifications in this publication are based on the latest product information available at the time of print.**
- COM Ordering Information and pricing on page 13.
- Remember to add an FC to the base model number when fire code fabric is selected. New Models with FC Fire Code suffix meet CA Technical Bulletin 133. See pages 28-31 for available models/fabrics.
- Wood components are well-seasoned select hardwoods, chosen for their strength, their ability to machine well and their superior uniformity of stain and finish.
- Chairs with leather feature matching vinyl backs and vinyl seat bottom when applicable (Non-contact areas are vinyl).

OPTIONS

CODES

Models H6551, H6552: Nail Trim around the Seat
Add \$25.00 upcharge.

B

FIRE CODE (CAL133)

Refer to CAL133 Compliant Seating matrices on pages 28-31 for a list of compliant models and fabrics. Add FC to the base model number.

Examples:

STANDARD: H2111.J.AB10

FIRE CODE: H2111FC.J.AB10

| Wood Seating | Finish Codes | | | | | | | | Standard Fabric Selections by Series with Price Code and Fabric Material | | | | | | | | | | | | | | | | | | | | | |
|-------------------------------------|----------------|--------|---------|----------|-------|---------------|----------|---------------|--|----|----|------|------|----|------|------|----|----|-----|------|-----|------|-----|------|----|-----|------|----|----|---|
| | Bourbon Cherry | Cognac | Harvest | Mahogany | Mocha | Natural Maple | Pinnacle | Shaker Cherry | AI | EB | CU | COMP | COMF | UR | DAPR | HAML | NR | OP | PNS | CLYD | DOT | RUSH | SED | SPNN | WP | ISN | PURL | SX | SS | |
| Cambia™ 2160 Series | H | COGN | C | N | MOCH | D | PINC | F | * | | * | * | | * | * | * | * | * | * | * | * | * | * | * | * | * | * | * | * | * |
| Convera™ | H | COGN | C | N | MOCH | D | PINC | F | | | * | * | | * | * | * | * | * | * | * | * | * | * | * | * | * | * | * | * | * |
| Invitation® 2110 Series | H | COGN | C | N | MOCH | D | PINC | F | * | | * | * | | * | * | * | * | * | * | * | * | * | * | * | * | * | * | * | * | * |
| Park Avenue Collection® 5000 Series | H | COGN | C | N | MOCH | D | PINC | F | | | * | * | | * | * | * | * | * | * | * | * | * | * | * | * | * | * | * | * | * |
| Pillow-Soft® 2190 Series | H | COGN | C | N | MOCH | D | PINC | F | | * | * | * | | * | * | * | * | * | * | * | * | * | * | * | * | * | * | * | * | * |
| Riley™ Series | H | COGN | C | N | MOCH | D | PINC | F | * | | * | * | | * | * | * | * | * | * | * | * | * | * | * | * | * | * | * | * | * |
| Versant® Tandem Wood | H | COGN | C | N | MOCH | D | PINC | F | * | | * | * | | * | * | * | * | * | * | * | * | * | * | * | * | * | * | * | * | * |
| 2400 Series | H | COGN | C | N | MOCH | | PINC | F | * | | * | * | | * | * | * | * | * | * | * | * | * | * | * | * | * | * | * | * | * |
| 6540 Series | H | COGN | C | N | MOCH | | PINC | F | | | * | * | | * | * | * | * | * | * | * | * | * | * | * | * | * | * | * | * | * |
| 6550 Series | H | COGN | C | N | MOCH | | PINC | F | | | * | * | | * | * | * | * | * | * | * | * | * | * | * | * | * | * | * | * | * |

Note: Gathers and creases may be more visible with AI and OP fabrics due to the inherent design and construction of these fabrics.

* Fabric is de-emphasized.

ORDERING INFORMATION

veneers for 2110 series — invitation® tables and table connectors

| | CODES |
|----------------|-------|
| Bourbon Cherry | H |
| Cognac | COGN |
| Harvest | C |
| Mahogany | N |
| Mocha | MOCH |
| Natural Maple | D |
| Pinnacle | PINC |
| Shaker Cherry | F |

laminates for versant® tandem freestanding tables

| | CODES |
|----------------|-------|
| Bourbon Cherry | H |
| Cognac | COGN |
| Harvest | C |
| Mahogany | N |
| Mocha | MOCH |
| Natural Maple | D |
| Pinnacle | PINC |
| Shaker Cherry | F |

veneers for wgn series — riley™ ganging tables

| | CODES |
|----------------|-------|
| Bourbon Cherry | H |
| Cognac | COGN |
| Mahogany | N |
| Mocha | MOCH |
| Natural Maple | D |
| Pinnacle | PINC |
| Shaker Cherry | F |

FIRE CODE/COMPLIANT SEATING

FIRE SAFETY WITHOUT COMPROMISE

Elevate Fire Safety to a Higher Standard

- You asked for more seating choices that meet the CAL 133 standard. Here they are. Many of The HON Company's most popular chair models are now available in an array of fabrics that include an advanced barrier of fire protection. This barrier helps HON chairs comply with CAL 133 (California Technical Bulletin 133), the industry's most stringent test for fire-retardant furniture.

Definitive Protection

- The resilient filling materials used in upholstered seating manufactured by The HON Company meet or exceed the flame retardant requirements of the State of California, Department of Consumer Affairs, Bureau of Electronic and Home Appliance Repair, Home Furnishings and Thermal Insulation Technical Bulletin 117-2013. The label attached to the seat bottom indicates compliance with these requirements.
- For public buildings with at least 10 chairs in use, CAL 133 sets the bar as the accepted standard of fire safety. The CAL-TB 117-2013 standard referenced above evaluates the fire resistance of fabric, but only CAL 133 tests the entire assembled chair. Result: Greater assurance that your seating will not accelerate an actual fire.

How to Order

- To ensure that the chairs you order comply with CAL 133, specify one of the fabrics listed here on any of the seating models from the pages that follow. Then simply add "FC" to the model number when ordering.

SPECIFYING EXAMPLE: H7808FC.NR62.T.

A standard upcharge of \$90 will be applied per seat model for all single seat chairs.

For Lounge Seating, the following upcharges will apply: (Please note, the lounge upcharges do not apply to the Ignition® or Versant® seating lines. For these models, the \$90 per seat applies.)

Single Seat/Club Lounge: \$250 list

2-Seat/Love Seat Lounge: \$325 list

3-Seat/Sofa: \$400 list

MOISTURE BARRIER

- This extra layer of protection prevents moisture from penetrating the foam to improve cleanability and extend product longevity. Moisture barrier is available as an option for the seat only. The recliner gets moisture barrier on seat and footrest.
- Moisture barrier is not available for the fire code models.**

How to Order

- Fire Code:** To ensure that the chairs you order comply with CAL 133, specify one of the fabrics listed here on any of the seating models from the pages that follow. Then simply add "FC" to the model number when ordering.

SPECIFYING EXAMPLE: HHCG11FC.S.AI90.P6N.

- Moisture Barrier:** When specifying Moisture Barrier simply add "MB" to the model number when ordering.

SPECIFYING EXAMPLE: HHCG11MB.S.AI90.P6N.

Upcharges for Fire Code and Moisture Barrier on Soothe® models

| Model | Fire Code | Moisture Barrier |
|---------|-----------|------------------|
| HHCG11 | \$90 | \$80 |
| HHCG50 | \$90 | \$120 |
| HHCG21 | \$180 | \$160 |
| HHCGB21 | \$180 | \$160 |
| HHCGB31 | \$270 | \$240 |
| HHCP1 | \$90 | \$80 |

FIRE CODE/COMPLIANT SEATING

CAL 133 COMPLIANT FABRIC

GRADE 1

AI Attire
COMP Compass
CU Centurion
NR Inertia
OP Optic

GRADE 2

DOT Dotty
PNS Appoint Seating
WP Whisper Vinyl

GRADE 3

SX Silvertex™ Vinyl

GRADE L

SS Leather

Motivate®, Olson® and GuestStacker® shell chairs available in CAL 133 compliant color options as of June 2014. Please see matrix below.

| SHELL COLOR | MOTIVATE® | OLSON® H4041 | GUESTSTACKER® H4031 |
|---------------|-----------|-----------------|------------------------|
| Onyx (ON) | X | X | X |
| Lava (LA) | X | X | X |
| Regatta (RE) | X | X | X |
| Mulberry (MB) | X | X | X |
| Shadow (SD) | X | X | |
| Platinum (PT) | X | X | |
| Lime (LM) | X | X | |
| Tangelo (RG) | X | X | |
| Surf (BU) | X | X | |
| Calypso (CP) | X | X | |
| Loft (LO) | X | X | |
| Cherry (CR) | X | X | |
| White (WT) | X | X | |

Creases and gathers may be visible with CAL 133 Fire Code seating due to the construction of the fire barrier material used.

FIRE CODE/COMPLIANT SEATING

To ensure that the chairs you order comply with CAL 133, choose one of these seating fabrics with the seating models listed here. Then simply add "FC" to the model number when ordering as shown here: **HIWM2FC.A.H.M.CU10.T.SB. A standard upcharge of \$90 will be applied per seat. Example, HILTL has 3 seats @ \$90 per seat, \$270 upcharge.**

CAL 133 Compliant Seating

ALL MODELS INCLUDED IN THIS PROGRAM ARE LISTED BELOW.

| Fabric Grade | 1 | 1 | 1 | 1 | 1 | 2 | 2 | 2 | 3 | L |
|-------------------------------------|--------|-----------|---------|---------|-------|---------|-------|---------------|-----------------|---------|
| Series/Model Numbers | Attire | Centurion | Compass | Inertia | Optic | Appoint | Dotty | Whisper Vinyl | Silvertex Vinyl | Leather |
| | AI | CU | COMP | NR | OP | PNS | DOT | WP | SX | SS |
| Accommodate® | | | | | | | | | | |
| HSGS6FC, HSGS6DFFC, HSCS1FC | * | * | * | * | * | * | * | * | * | * |
| HSCS1DFFC, HSCS2FC, HSCS2DFFC | * | * | * | * | * | * | * | * | * | * |
| HSB50FC, HSB50DFFC | * | * | * | * | * | * | * | * | * | * |
| Cambia™ | | | | | | | | | | |
| H2164FC, H2165FC | * | * | * | * | * | * | * | * | * | * |
| Ceres® | | | | | | | | | | |
| HCW1FC, HCG6FC | * | * | * | * | * | * | * | * | * | * |
| ComfortTask® | | | | | | | | | | |
| H5901FC, H5902FC, H5903FC | * | * | * | * | * | * | * | * | * | * |
| H5905FC | * | * | * | * | * | * | * | * | * | * |
| Convera™ Lounge | | | | | | | | | | |
| HDAC01FC, HDAA01FC, HDAL02FC | | * | * | * | * | * | * | * | * | * |
| Endorse® | | | | | | | | | | |
| HLEUFC, HLWMFC, HLTMFC | * | * | * | * | * | * | * | * | * | * |
| HLWMBTFC, HLTSMFC | * | * | * | * | * | * | * | * | * | * |
| HL1SLFC, HL2SLFC, HL3SLFC | * | * | * | * | * | * | * | * | * | * |
| HLWUFC, HLTUFC, HLTDFC | * | * | * | * | * | * | * | * | * | * |
| HLWUBTFC, HLEUBTFC, HLTSUFC | * | * | * | * | * | * | * | * | * | * |
| HLTSPFC | * | * | * | * | * | * | * | * | * | * |
| Flock® Seating | | | | | | | | | | |
| HFLSC1FC, HFLMC1FC, HFLML1FC | * | * | * | * | * | * | * | * | * | * |
| HFLMR1FC, HFLSO1FC | * | * | * | * | * | * | * | * | * | * |
| Gamut® | | | | | | | | | | |
| H2071FC, H2072FC | | * | * | * | * | * | * | * | * | * |
| H2073FC | | * | * | * | * | * | * | * | * | * |
| Grove® | | | | | | | | | | |
| HML1SFC, HML1SDFFC, HML2SFC | | * | * | * | * | * | * | * | * | * |
| HML2SDFFC, HML3SFC, HML3SDFFC | | * | * | * | * | * | * | * | * | * |
| HML2STFC, HML2STDFFC | | * | * | * | * | * | * | * | * | * |
| Ignition® Seating | | | | | | | | | | |
| HIEH1FC, HIEH2FC, HIEH3FC | * | * | * | * | * | * | * | * | * | * |
| HIEH4FC, HIWM1FC, HIWM2FC | * | * | * | * | * | * | * | * | * | * |
| HIWM3FC, HIWM4FC, HIWM8FC | * | * | * | * | * | * | * | * | * | * |
| HITL1FC, HITL2FC, HITL3FC | * | * | * | * | * | * | * | * | * | * |
| HITL4FC, HITS5FC, HIGCLFC | * | * | * | * | * | * | * | * | * | * |
| HIGS6FC, HISB6FC, HICS7FC | * | * | * | * | * | * | * | * | * | * |
| HIL2LFC, HIB50FC, HIHCFC | * | * | * | * | * | * | * | * | * | * |
| HILTLFC | * | * | * | * | * | * | * | * | * | * |
| HITLMFC, HIWMMFC, HITSMFC | * | * | * | * | * | * | * | * | * | * |
| Invitation® | | | | | | | | | | |
| H2111FC, H2112FC | * | * | * | * | * | * | * | * | * | * |
| Invitation® Lounge | | | | | | | | | | |
| HFAA01FC, HFAL02FC, HFAS03FC | * | * | * | * | * | * | * | * | * | * |
| Motivate® | | | | | | | | | | |
| HMG2FC, HMG7FC, HMG22FC | * | * | * | * | * | * | * | * | * | * |
| HMN2FC, HMNT2FC, HMS2FC | * | * | * | * | * | * | * | * | * | * |
| HMT1FC, HMT5FC | * | * | * | * | * | * | * | * | * | * |
| HMN1FC (Fire Code Lava shell only) | | | | | | | | | | |
| HMNT1FC (Fire Code Lava shell only) | | | | | | | | | | |

FIRE CODE/COMPLIANT SEATING

To ensure that the chairs you order comply with CAL 133, choose one of these seating fabrics with the seating models listed here. Then simply add “FC” to the model number when ordering as shown here: **HIWM2FC.A.H.M.CU10.T.SB. A standard upcharge of \$90 will be applied per seat. Example, HILTL has 3 seats @ \$90 per seat, \$270 upcharge.**

CAL 133 Compliant Seating

ALL MODELS INCLUDED IN THIS PROGRAM ARE LISTED BELOW.

| Fabric Grade | 1 | 1 | 1 | 1 | 1 | 2 | 2 | 2 | 3 | L |
|----------------------------------|--------|-----------|---------|---------|-------|---------|-------|---------------|-----------------|---------|
| Series/Model Numbers | Attire | Centurion | Compass | Inertia | Optic | Appoint | Dotty | Whisper Vinyl | Silvertex Vinyl | Leather |
| | AI | CU | COMP | NR | OP | PNS | DOT | WP | SX | SS |
| Nucleus® Seating | | | | | | | | | | |
| HN1FC, HN6FC, HN7FC | • | • | • | • | • | • | • | • | • | • |
| Pagoda® | | | | | | | | | | |
| H4071FC, H4073FC, H4075FC | • | • | • | • | • | • | • | • | • | |
| H4077FC, H4079FC, H4091FC | • | • | • | • | • | • | • | • | • | |
| H4093FC, H4095FC, H4097FC | • | • | • | • | • | • | • | • | • | |
| H4099FC | • | • | • | • | • | • | • | • | • | |
| Park Avenue Collection® | | | | | | | | | | |
| H5001FC, H5002FC | | • | • | • | | • | | | | • |
| H5021FC, H5022FC | | • | • | • | | • | | | | • |
| H5003FC, H5023FC | | • | • | • | • | • | | • | • | • |
| Perpetual® Nesting Chairs | | | | | | | | | | |
| HPN1FC, HPN2FC | • | • | • | • | • | • | • | • | • | |
| Pillow-Soft® | | | | | | | | | | |
| H2091FC, H2092FC, H2191FC | | • | • | • | • | • | | | | |
| H2192FC | | • | • | • | • | • | | | | |
| H2093FC, H2194FC | | • | • | • | • | • | • | • | • | |
| Purpose® | | | | | | | | | | |
| HR1PFC, HR1SFC, HR1WFC | | • | | | | | | | • | |
| HR5PFC, HR5SFC, HR5WFC | | • | | | | | | | • | |
| Quotient® | | | | | | | | | | |
| HQTMMFC, HQTSMFC | • | • | • | • | • | • | • | • | • | • |
| Riley™ | | | | | | | | | | |
| HWGN1FC, HWGN2FC, HWGN3FC | • | • | • | • | • | • | • | • | • | • |
| HWGN4FC, HWGN5FC, HWGN1BFC | • | • | • | • | • | • | • | • | • | • |
| HWGN2BFC, HWGN3BFC | • | • | • | • | • | • | • | • | • | • |
| HWGN4BFC, HWGN5BFC | • | • | • | • | • | • | • | • | • | • |
| Solutions Seating® | | | | | | | | | | |
| H4001FC, H4002FC | • | • | • | • | | • | | | | |
| H4003FC, H4008FC | • | • | • | • | • | • | • | • | • | |
| Solve® | | | | | | | | | | |
| HSLVTMMFC, HSLVSMFC | • | • | • | • | • | • | • | • | • | • |
| Soothe® | | | | | | | | | | |
| HHCG11FC, HHCG50FC, HHCG21FC | • | • | • | • | • | • | • | • | • | • |
| HHCGB21FC, HHCGB31FC | • | • | • | • | • | • | • | • | • | • |
| HHCP1FC | | | | | | | | | • | |
| Versant® | | | | | | | | | | |
| HHCT01FC, HHCT12FC, HHCT02FC | • | • | • | • | • | • | • | • | • | • |
| HHCB50FC, HHB02FC, HHB03FC | • | • | • | • | • | • | • | • | • | • |
| 2400 Series | | | | | | | | | | |
| H2403FC | • | • | • | • | • | • | • | • | • | • |
| 7800 Series Seating | | | | | | | | | | |
| H7803FC, H7808FC, H7823FC | • | • | • | • | • | • | • | • | • | • |
| H7828FC | • | • | • | • | • | • | • | • | • | • |

ACCOMMODATE®



Accommodate Guest Chairs shown with Arrange® Table.

ACCOMMODATE®

The key to designing a collaborative environment is to support productivity throughout the space. From waiting areas and cafés to meeting spaces and offices, Accommodate creates opportunities for people to get work done in a comfortable, casual setting. Cluster together. Form neat rows. Stack four high. With guest and bariatric chairs, as well as café and counter-height stools, Accommodate brings greater comfort, versatility and continuity throughout your space with a seating collection that adapts to your environment, people and budget.



FEATURES

- Thin profile seat cushion conforms to your body.
- Contoured back ergonomically supports the spine.
- Chairs can stack up to four high.
- Chairs can gang together to form neat rows.
- Waterfall seat edge enhances leg circulation.
- Lightweight frame is easy to move.
- Nylon glides slide effortlessly on hard surfaces.
- Tube rolled steel frame adds durability.
- Wall-saver design protects walls and cabinets.
- Warranted for users up to 300 lbs. (Models HSB50 and HSB50DF are warranted for users up to 500 lbs.)

MODEL OPTIONS

HSGS6
HSGS6DF - Dual Fabric



Guest Chair

HSCS1
HSCS1DF - Dual Fabric



Counter-Height Stool

HSCS2
HSCS2DF - Dual Fabric



Café-Height Stool

HSB50
HSB50DF - Dual Fabric

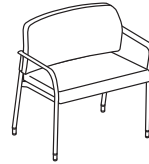

Bariatric Chair

ARM STYLE

| CODE | DESCRIPTION | PRICE |
|----------|-------------|--------------|
| N | Armless | +\$0 |
| F | Fixed Arms | +\$30 |



FRAME

| CODE | DESCRIPTION | PRICE |
|-------------|-----------------------|-------------|
| P6N | Textured Satin Chrome | +\$0 |
| BLCK | Textured Black | +\$0 |



CASTERS/ GLIDES

| CODE | DESCRIPTION | PRICE |
|----------|---|--------------|
| E | Standard Nylon Glide | +\$0 |
| H | Hard Caster | +\$0 |
| S | Soft Caster | +\$20 |
| B | Both Hard Casters and Standard Nylon Glides | +\$20 |



*Options H, S & B available for HSGS6 and HSGS6DF models only

ACCOMMODATE[®]

Fabric Options

HON BRANDED FABRICS

GRADE 1

Attire
Centurion
Compass
Contourette Polyurethane
Dapper
Hamilton
Inertia
Optic

GRADE 2

Appoint Seating
Clyde
Dotty
Rush
Seed
Spin Seating
Whisper Vinyl

GRADE 3

In Season
Purl
Silvertex™ Vinyl

GRADE L

Denver Leather

For a complete list of fabrics, including partnership fabrics, go to hon.com/fabricsandfinishes.

Reference Fabric Color Combinations on pages 20-24 for color codes and legend on page 21 for lead times.

 For Fire Code model, availability and ordering method, refer to pages 28-31. Available on select models, contact HON Customer Support for availability.



Icon Legend on page 17

ACCOMMODATE®

HSGS6

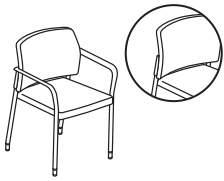

GUEST CHAIR

Set of Two Guest Chairs

DIMENSIONS

| | | | |
|--------------------|-----|--------------------------|----------|
| Depth: | 22¼ | Seat to Floor Height: | 18¼ |
| Height: | 31½ | Usable Seat Depth: | 17 |
| Seat Depth: | 20¾ | Ship Weight (with arms): | 50 |
| Seat Width: | 17½ | Ship Weight (armless): | 48 |
| Back Width: | 19¾ | Cube (with arms): | 15.8 |
| Back Height: | 16¼ | Cube (armless): | 15.8 |
| Width (with arms): | 23½ | COM (with arms): | 2.0 |
| Width (armless): | 19¾ | COM (armless): | 2.0 |
| Arm Width: | 20¼ | Weight Rating: | 300 lbs. |

FABRIC PRICE CODES

| | | | |
|---|--------|----|--------|
| 1 | \$728 | 8 | \$1142 |
| 2 | \$800 | 9 | \$1196 |
| 3 | \$872 | 10 | \$1250 |
| 4 | \$926 | 11 | \$1304 |
| 5 | \$980 | 12 | \$1358 |
| 6 | \$1034 | L | — |
| 7 | \$1088 | | |

NOTES: For Ganging Brackets see page 38. Accommodate® Guest Chairs stack 4-high.

HSCS1

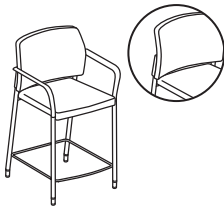

COUNTER-HEIGHT STOOL

DIMENSIONS

| | | | |
|--------------------|-----|--------------------------|----------|
| Depth: | 23½ | Seat to Floor Height: | 25½ |
| Height: | 38¾ | Usable Seat Depth: | 17 |
| Seat Depth: | 20¾ | Ship Weight (with arms): | 36 |
| Seat Width: | 17½ | Ship Weight (armless): | 35 |
| Back Width: | 19¾ | Cube (with arms): | 15.8 |
| Back Height: | 16¼ | Cube (armless): | 15.8 |
| Width (with arms): | 23½ | COM (with arms): | 2.0 |
| Width (armless): | 19¾ | COM (armless): | 2.0 |
| Arm Width: | 20¼ | Weight Rating: | 300 lbs. |

FABRIC PRICE CODES

| | | | |
|---|-------|----|-------|
| 1 | \$433 | 8 | \$640 |
| 2 | \$469 | 9 | \$667 |
| 3 | \$505 | 10 | \$694 |
| 4 | \$532 | 11 | \$721 |
| 5 | \$559 | 12 | \$748 |
| 6 | \$586 | L | — |
| 7 | \$613 | | |

HON Recommendation: HSGS6.N.E.CU__P6N - List Price \$728

HOW TO SPECIFY

| | | | | |
|--|---|--|---|--|
| <p>Select Model Number</p> <p>H S G S 6 .</p> | <p>Select Arm Type</p> <p>N Armless F Fixed Arms (+ \$30 per chair)</p> <p>N .</p> | <p>Select Caster/Glide</p> <p>E Standard Nylon Glide H Hard Caster S Soft Caster (+ \$20 per chair) B Both Hard Casters and Standard Nylon Glides (+ \$20 per chair)</p> <p><i>Options H, S & B available for HSGS6 model only</i></p> <p>E .</p> | <p>Select Fabric</p> <p>See page 34</p> <p>C U 1 0 .</p> | <p>Select Frame</p> <p>P6N Textured Satin Chrome BLCK Textured Black</p> <p>P 6 N</p> |
|--|---|--|---|--|

ACCOMMODATE®



Icon Legend on page 17

HSCS2

CAFÉ-HEIGHT STOOL



DIMENSIONS

| | | | |
|--------------------|-----|--------------------------|----------|
| Depth: | 24½ | Seat to Floor Height: | 31½ |
| Height: | 44¾ | Usable Seat Depth: | 17 |
| Seat Depth: | 20¾ | Ship Weight (with arms): | 38 |
| Seat Width: | 17½ | Ship Weight (armless): | 37 |
| Back Width: | 19¾ | Cube (with arms): | 19.1 |
| Back Height: | 16¼ | Cube (armless): | 19.1 |
| Width (with arms): | 23½ | COM (with arms): | 2.0 |
| Width (armless): | 19¾ | COM (armless): | 2.0 |
| Arm Width: | 20¼ | Weight Rating: | 300 lbs. |

FABRIC PRICE CODES

| | | | |
|---|-------|----|-------|
| 1 | \$475 | 8 | \$682 |
| 2 | \$511 | 9 | \$709 |
| 3 | \$547 | 10 | \$736 |
| 4 | \$574 | 11 | \$763 |
| 5 | \$601 | 12 | \$790 |
| 6 | \$628 | L | — |
| 7 | \$655 | | |

HSB50

BARIATRIC CHAIR

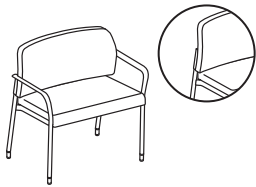

DIMENSIONS

| | | | |
|--------------------|-----|--------------------------|----------|
| Depth: | 21½ | Seat to Floor Height: | 19 |
| Height: | 32½ | Usable Seat Depth: | 16¾ |
| Seat Depth: | 20¼ | Ship Weight (with arms): | 50 |
| Seat Width: | 28 | Ship Weight (armless): | 49 |
| Back Width: | 29 | Cube (with arms): | 27.2 |
| Back Height: | 16½ | Cube (armless): | 27.2 |
| Width (with arms): | 33½ | COM (with arms): | 2.0 |
| Width (armless): | 30 | COM (armless): | 2.0 |
| Arm Width: | 30 | Weight Rating: | 500 lbs. |

FABRIC PRICE CODES

| | | | |
|---|--------|----|--------|
| 1 | \$765 | 8 | \$1041 |
| 2 | \$813 | 9 | \$1077 |
| 3 | \$861 | 10 | \$1113 |
| 4 | \$897 | 11 | \$1149 |
| 5 | \$933 | 12 | \$1185 |
| 6 | \$969 | L | — |
| 7 | \$1005 | | |

HON Recommendation: HSCS2.N.E.CU__P6N - List Price \$475

HOW TO SPECIFY

Select Model Number

H S C S 2 .

Select Arm Type

N Armless
F Fixed Arms
(+ \$30 per chair)

N .

Select Caster/Glide

E Standard Nylon Glide

E .

Select Fabric

See page 34

C U 1 0 .

Select Frame

P6N Textured Satin Chrome
BLCK Textured Black

P 6 N



HSGS6DF

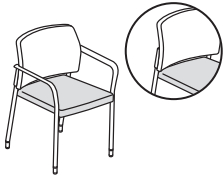

GUEST CHAIR

Dual Fabric
Set of Two Guest Chairs

DIMENSIONS

| | | | |
|--------------------|-----|--------------------------|----------|
| Depth: | 22¼ | Seat to Floor Height: | 18¼ |
| Height: | 31½ | Usable Seat Depth: | 17 |
| Seat Depth: | 20¾ | Ship Weight (with arms): | 50 |
| Seat Width: | 17½ | Ship Weight (armless): | 48 |
| Back Width: | 19¾ | Cube (with arms): | 15.8 |
| Back Height: | 16¼ | Cube (armless): | 15.8 |
| Width (with arms): | 23½ | COM (with arms): | 2.0 |
| Width (armless): | 19¾ | COM (armless): | 2.0 |
| Arm Width: | 20¼ | Weight Rating: | 300 lbs. |

FABRIC PRICE CODES

| | | |
|--------------------------------|--------------|--------------|
| 1 | \$878 | |
| <i>Add to Base Price Above</i> | | |
| | Back | Seat |
| 2 | \$36 | \$36 |
| 3 | \$72 | \$72 |
| 4 | \$99 | \$99 |
| 5 | \$126 | \$126 |
| 6 | \$153 | \$153 |
| 7 | \$180 | \$180 |
| 8 | \$207 | \$207 |
| 9 | \$234 | \$234 |
| 10 | \$261 | \$261 |
| 11 | \$288 | \$288 |
| 12 | \$315 | \$315 |

NOTES: For Ganging Brackets see page 38. Accommodate® Guest Chairs stack 4-high.

HSCS1DF

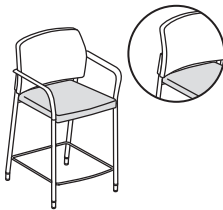

COUNTER-HEIGHT STOOL

Dual Fabric

DIMENSIONS

| | | | |
|--------------------|-----|--------------------------|----------|
| Depth: | 23½ | Seat to Floor Height: | 25½ |
| Height: | 38¾ | Usable Seat Depth: | 17 |
| Seat Depth: | 20¾ | Ship Weight (with arms): | 36 |
| Seat Width: | 17½ | Ship Weight (armless): | 35 |
| Back Width: | 19¾ | Cube (with arms): | 15.8 |
| Back Height: | 16¼ | Cube (armless): | 15.8 |
| Width (with arms): | 23½ | COM (with arms): | 2.0 |
| Width (armless): | 19¾ | COM (armless): | 2.0 |
| Arm Width: | 20¼ | Weight Rating: | 300 lbs. |

FABRIC PRICE CODES

| | | |
|--------------------------------|--------------|--------------|
| 1 | \$508 | |
| <i>Add to Base Price Above</i> | | |
| | Back | Seat |
| 2 | \$18 | \$18 |
| 3 | \$36 | \$36 |
| 4 | \$50 | \$50 |
| 5 | \$63 | \$63 |
| 6 | \$77 | \$77 |
| 7 | \$90 | \$90 |
| 8 | \$104 | \$104 |
| 9 | \$117 | \$117 |
| 10 | \$131 | \$131 |
| 11 | \$144 | \$144 |
| 12 | \$158 | \$158 |

HON Recommendation: HSGS6DF.N.E.CU__CU__P6N - List Price \$878

HOW TO SPECIFY

| | | | | | |
|-----------------------------------|--|---|---|---|---|
| <p>Select Model Number</p> | <p>Select Arm Type</p> <p>N Armless F Fixed Arms (+ \$30 per chair)</p> | <p>Select Caster/Glide</p> <p>E Standard Nylon Glide H Hard Caster S Soft Caster (+ \$20 per chair) B Both Hard Casters and Standard Nylon Glides (+ \$20 per chair)</p> <p><i>Options H, S & B available for HSGS6DF model only</i></p> | <p>Select Back Fabric</p> <p>See page 34</p> | <p>Select Seat Fabric</p> <p>See page 34</p> | <p>Select Frame</p> <p>P6N Textured Satin Chrome BLCK Textured Black</p> |
| H S G S 6 D F . | N . | E . | C U 2 2 . | C U 1 0 . | P 6 N |

ACCOMMODATE®



Icon Legend on page 17

HSCS2DF



CAFÉ-HEIGHT STOOL

Dual Fabric

DIMENSIONS

| | | | |
|--------------------|-----|--------------------------|----------|
| Depth: | 24½ | Seat to Floor Height: | 31½ |
| Height: | 44¾ | Usable Seat Depth: | 17 |
| Seat Depth: | 20¾ | Ship Weight (with arms): | 38 |
| Seat Width: | 17½ | Ship Weight (armless): | 37 |
| Back Width: | 19¾ | Cube (with arms): | 19.1 |
| Back Height: | 16¼ | Cube (armless): | 19.1 |
| Width (with arms): | 23½ | COM (with arms): | 2.0 |
| Width (armless): | 19¾ | COM (armless): | 2.0 |
| Arm Width: | 20¼ | Weight Rating: | 300 lbs. |

FABRIC PRICE CODES

1 \$550

Add to Base Price Above

| | Back | Seat |
|----|-------|-------|
| 2 | \$18 | \$18 |
| 3 | \$36 | \$36 |
| 4 | \$50 | \$50 |
| 5 | \$63 | \$63 |
| 6 | \$77 | \$77 |
| 7 | \$90 | \$90 |
| 8 | \$104 | \$104 |
| 9 | \$117 | \$117 |
| 10 | \$131 | \$131 |
| 11 | \$144 | \$144 |
| 12 | \$158 | \$158 |

HSB50DF

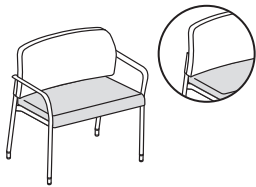

BARIATRIC CHAIR

Dual Fabric

DIMENSIONS

| | | | |
|--------------------|-----|--------------------------|----------|
| Depth: | 21½ | Seat to Floor Height: | 19 |
| Height: | 32½ | Usable Seat Depth: | 16¾ |
| Seat Depth: | 20¼ | Ship Weight (with arms): | 50 |
| Seat Width: | 28 | Ship Weight (armless): | 49 |
| Back Width: | 29 | Cube (with arms): | 27.2 |
| Back Height: | 16½ | Cube (armless): | 27.2 |
| Width (with arms): | 33½ | COM (with arms): | 2.0 |
| Width (armless): | 30 | COM (armless): | 2.0 |
| Arm Width: | 30 | Weight Rating: | 500 lbs. |

FABRIC PRICE CODES

1 \$840

Add to Base Price Above

| | Back | Seat |
|----|-------|-------|
| 2 | \$24 | \$24 |
| 3 | \$48 | \$48 |
| 4 | \$66 | \$66 |
| 5 | \$84 | \$84 |
| 6 | \$102 | \$102 |
| 7 | \$120 | \$120 |
| 8 | \$138 | \$138 |
| 9 | \$156 | \$156 |
| 10 | \$174 | \$174 |
| 11 | \$192 | \$192 |
| 12 | \$210 | \$210 |

HSGANG



GANGING BRACKET

(hardware included)

DIMENSIONS

Ship Weight: 5 Ⓞ

LIST PRICE

\$32

NOTES: For use on models HSGS6 and HSGS6DF.

ⓘ No specification required for bracket. The ganging bracket is only available in black. The ganging bracket does not work on the bariatric unit.

HON Recommendation: HSCS2DF.N.E.CU__CU__P6N - List Price \$550

HOW TO SPECIFY

| | | | | | |
|---|--|--|--|--|--|
| Select Model Number H S C S 2 D F . | Select Arm Type N Armless F Fixed Arms (+ \$30) | Select Caster/Glide E Standard Nylon Glide | Select Back Fabric See page 34 | Select Seat Fabric See page 34 | Select Frame P6N Textured Satin Chrome BLK Textured Black |
| H S C S 2 D F . | N . | E . | C U 2 2 . | C U 1 0 . | P 6 N |



ADJUSTABLE TASK/LAB Stools

HMTS01

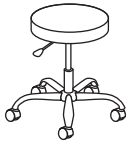

TASK/LAB STOOL

without Back

Pneumatic
Swivel

Functions: **A, E**

(Function Key on pages 18-19)

DIMENSIONS

| | | | |
|---------|----------|-----------------------|-------------|
| Depth: | 27¼ | Seat to Floor Height: | 17¾-22 |
| Width: | 24⅝ | Usable Seat Depth: | 16 |
| Height: | 17¾-22 | Ship Weight: | 22 Ⓢ |
| Seat: | 16" Dia. | Cube: | 2.5 |
| | | Weight Rating: | 250 lbs. |

FABRIC PRICE CODE

1 \$293

NOTES: EA vinyl is a healthcare covering that meets AATCC Test Method 147-2004.

! Available in polished base ONLY. Available in Grade 1, Black, EA11 fabric ONLY.

HMTS11

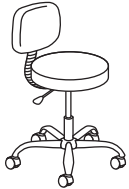

TASK/LAB STOOL

with Back

Pneumatic
Back Height
Seat Depth
Swivel

Functions: **A, B, C, E**

(Function Key on pages 18-19)

DIMENSIONS

| | | | |
|--------------|----------|-----------------------|-------------|
| Depth: | 27¼ | Seat to Floor Height: | 17¾-22 |
| Width: | 24⅝ | Usable Seat Depth: | 14¾-16 |
| Height: | 31½-38 | Ship Weight: | 29 Ⓢ |
| Seat: | 16" Dia. | Cube: | 2.7 |
| Back Width: | 15½ | Weight Rating: | 250 lbs. |
| Back Height: | 8¾-16 | | |

FABRIC PRICE CODE

1 \$392

NOTES: EA vinyl is a healthcare covering that meets AATCC Test Method 147-2004.

! Available in polished base ONLY. Available in Grade 1, Black, EA11 fabric ONLY.

HOW TO SPECIFY

| | |
|----------------------------|----------------------------|
| Select Model Number | Select Fabric |
| | EA11 Black, Grade 1 (only) |
| H M T S 0 1 . | E A 1 1 |

ASSEMBLE™ Nesting/Stacking Chairs

OPEN MARKET



Icon Legend on page 17

HVL304



NESTING/STACKING

Upholstered Seat and Mesh
Back
Casters
Armless
Ships 2 per Carton

DIMENSIONS

| | | | |
|-------------|-----|-----------------------|----------|
| Depth: | 24 | Seat to Floor Height: | 17 |
| Width: | 24 | Usable Seat Depth: | 17 |
| Height: | 34¾ | Ship Weight: | 29.7 |
| Seat Depth: | 17 | Cube: | 9.0 |
| Seat Width: | 18 | Weight Rating: | 250 lbs. |
| Back Width: | 16¾ | | |

LIST PRICE PER CARTON

\$435
(reference single unit @
\$217.50

NOTES: Stacks 4-high. Comfortable and breathable mesh back. Armless. Black fabric seat. Specify Black (T) or Silver (X) frame. Ships two per carton. **HON 5-Year Limited Warranty.**

Mesh Nesting Chairs are ordered and shipped two (2) chairs per carton. Pricing shown is per carton. Each set of two chairs (one carton) must have the same fabric/frame color. Ordering 2 of any model will result in 2 cartons being shipped, giving you 4 chairs.

HON Recommendation: HVL304.VA10.T - List Price \$435

HVL314



NESTING/STACKING

Upholstered Seat and Mesh
Back
Casters
Arms
Ships 2 per Carton

DIMENSIONS

| | | | |
|-------------|-----|-----------------------|----------|
| Depth: | 24 | Arm Width: | 18 |
| Width: | 24 | Seat to Floor Height: | 17 |
| Height: | 34¾ | Usable Seat Depth: | 17 |
| Seat Depth: | 17 | Ship Weight: | 29.7 |
| Seat Width: | 18 | Cube: | 9.2 |
| Back Width: | 16¾ | Weight Rating: | 250 lbs. |

LIST PRICE PER CARTON

\$455
(reference single unit @
\$227.50

NOTES: Stacks 4-high. Comfortable and breathable mesh back. With arms. Black fabric seat. Specify Black (T) or Silver (X) frame. Ships two per carton. **HON 5-Year Limited Warranty.**

Mesh Nesting Chairs are ordered and shipped two (2) chairs per carton. Pricing shown is per carton. Each set of two chairs (one carton) must have the same fabric/frame color. Ordering 2 of any model will result in 2 cartons being shipped, giving you 4 chairs.

HON Recommendation: HVL314.VA10.T - List Price \$455

HOW TO SPECIFY

Select
Model Number

H V L 3 0 4 .

Select
Fabric

VA10 Black







V A 1 0 .

Select
Frame

T Black
X Silver

T

ASSEMBLE™ Multi-Purpose Tables

| | DESCRIPTION | MODEL | SHIP WEIGHT | CUBE | LIST PRICE |
|--|--|------------------|-------------|------|--------------|
|   OPEN MARKET | Flip Base Table | | | | |
| | 72"W x 24"D | HBMP7224P | 100 | 8.9 | \$541 |
| | 60"W x 24"D | HBMP6024P | 88 | 7.5 | \$510 |
| | 48"W x 24"D | HBMP4824P | 76 | 6.7 | \$482 |
| | NOTES: Choose from three widths and two base styles. All table tops 24"D. Table tops standard with two round 2½" grommets. Table tops and bases ship in one box. HON 5-Year Limited Warranty. | | | | |
| | ! Bases available in Black paint only, no need to specify. | | | | |
|   OPEN MARKET | Fixed Base Table | | | | |
| | 72"W x 24"D | HBMP7224X | 95 | 8.9 | \$460 |
| | 60"W x 24"D | HBMP6024X | 83 | 7.5 | \$429 |
| | 48"W x 24"D | HBMP4824X | 71 | 6.7 | \$401 |
| | NOTES: Choose from three widths and two base styles. All table tops 24"D. Table tops standard with two round 2½" grommets. Table tops and bases ship in one box. HON 5-Year Limited Warranty. | | | | |
| | ! Bases available in Black paint only, no need to specify. | | | | |
|  OPEN MARKET | Mesh Modesty Panels | | | | |
| | 72"W | HBMP72MOD | 4 Ⓢ | 0.3 | \$142 |
| | 60"W | HBMP60MOD | 3 Ⓢ | 0.3 | \$126 |
| | 48"W | HBMP48MOD | 2 Ⓢ | 0.2 | \$115 |
| | NOTES: Mesh Modesty Panels work with Multi-Purpose Table and Manage® Desk models. HON 5-Year Limited Warranty. | | | | |
| | ! Available in Black Mesh fabric only, specify .X. | | | | |
|  SIN 711-11 | Ganging Hardware | HMAGANG | 1 Ⓢ | 0.1 | \$86 |
| | <ul style="list-style-type: none"> • Must be ordered and installed on tables when using 4-trac electrical systems. • Attaches to underside of table in pre-drilled pilot holes. • Includes two ganging links and two screws • No color designator when specifying. <i>Example: HMAGANG.</i> • HON 5-Year Limited Warranty. | | | | |

HOW TO SPECIFY

| | |
|------------------------------|--|
| <p>Select Model Number</p> | <p>Select Laminate</p> <p>C1 Chestnut QZ Light Gray WH Wheat</p> |
| <p>H B M P T 7 2 2 4 P .</p> | <p>C 1</p> |

BODA™



Shown with 10500 Series™ desks.

BODA™

Look cool. Stay cool. Boda task chairs rely on breathable mesh that increases airflow to prevent hot spots and maximize comfort. Each high-back task chair features a mesh back with a choice of mesh seat or upholstered seat for maximum comfort. To take the comfort to an even higher level, the 2-to-1 synchro-tilt recline control provides a stable, comfortable ride, making it perfect for executive offices and meeting spaces.



FEATURES

- Breathable mesh back delivers all-day comfort.
- Mesh seat option is breathable and offers all-day support.
- Upholstered seat option includes ample foam cushioning.
- Responsive synchro-tilt control provides a smooth, natural recline.
- Arms move up or down for shoulder and upper body support.
- Tilt tension controls the rate and ease of recline.
- Tilt lock allows the user to lock out the tilt function.
- One-touch seat height adjustment easily moves the seat up and down.
- 360-degree swivel provides freedom of movement in any direction.
- Warranted for users up to 275 lbs.



HMH01



TASK CHAIR

High-back
 Pneumatic
 Synchro-tilt
 Tilt Tension
 Tilt Lock
 Height-adjustable Arms
 Mesh Sandwich Fabric Seat and Mesh Back

DIMENSIONS

| | | | |
|--------------|-----|-----------------------|-------------|
| Depth: | 35½ | Arm Width: | 19¼ |
| Width: | 27¾ | Seat to Floor Height: | 18¼-22½ |
| Height: | 44 | Usable Seat Depth: | 17⅞ |
| Seat Depth: | 17⅞ | Ship Weight: | 43 Ⓢ |
| Seat Width: | 20¾ | Cube: | 5.1 |
| Back Width: | 19¾ | Weight Rating: | 250 lbs. |
| Back Height: | 24¼ | | |

LIST PRICE

\$739

Functions: **A, E, J, K, L, Q**
 (Function Key on pages 18-19)

NOTES: Model HMH01 available with Black Mesh back and Black Sandwich Mesh fabric seat.

! Titanium frame only available on both models.

HMH02



TASK CHAIR

High-back
 Pneumatic
 Synchro-tilt
 Tilt Tension
 Tilt Lock
 Height-adjustable Arms
 Mesh Seat and Back

DIMENSIONS

| | | | |
|--------------|-----|-----------------------|-------------|
| Depth: | 35½ | Arm Width: | 17½ |
| Width: | 27 | Seat to Floor Height: | 18½-22¾ |
| Height: | 44¼ | Usable Seat Depth: | 18¼ |
| Seat Depth: | 18¼ | Ship Weight: | 44 Ⓢ |
| Seat Width: | 20 | Cube: | 5.1 |
| Back Width: | 19¾ | Weight Rating: | 250 lbs. |
| Back Height: | 24¾ | | |

LIST PRICE

\$853

Functions: **A, E, J, K, L, Q**
 (Function Key on pages 18-19)

NOTES: HMH02 available with Black Mesh seat and back.

! Titanium frame only available on both models.

HON Recommendation: HMH01.MM10.C - List Price \$739

HOW TO SPECIFY

| | | |
|--|---|--|
| <p>Select Model Number</p> <p>H M H 0 1 .</p> | <p>Select Seat</p> <p>MM10 Black Sandwich Mesh — (HMH01 ONLY) MST1 Black Mesh — (HMH02 ONLY)</p> <p>M M 1 0 .</p> | <p>Select Frame</p> <p>C Titanium</p> <p>C</p> |
|--|---|--|

CAMBIA™ 2160 SERIES



**Cambia Upholstered Back Guest
Chairs shown with Preside® table.**

CAMBIA™ 2160 SERIES

Cambia's comfort and style is a warm invitation for any guest or coworker. With two back variations and arm options, this is a guest chair collection designed to adapt. Each back option offers a choice of a wood slat design or upholstered panel to suit any space or personal taste. Choose from eight rich hardwood finishes and hundreds of quality HON fabrics to express your style and reflect your brand.



FEATURES

- Wood slat back panel complements a variety of surroundings.
- Upholstered seat and back features cushioning for additional comfort and support.
- Personalize your space with a choice of back styles.
- Fixed arms enhance take pressure off the upper body and shoulders.
- Solid hardwood in one of eight attractive finishes.
- Available in hundreds of quality HON fabrics.
- Warranted for users up to 250 lbs.

CAMBIA™

2160 Series Options

MODEL OPTIONS

H2164



Guest Chair

Upholstered Back, Leg Base,
Arch Arms

H2165



Guest Chair

Wood Slat Back, Leg Base,
Arch Arms

AVAILABLE FINISHES

Cambia™ 2160 Series Seating is available in 8 wood finishes.

WOOD FINISHES

Bourbon Cherry (H)

Cognac (COGN)

Harvest (C)

Mahogany (N)

Mocha (MOCH)

Natural Maple (D)

Pinnacle (PINC)

Shaker Cherry (F)

HON BRANDED FABRICS

GRADE 1

Attire
Centurion
Compass
Contourette Polyurethane
Dapper
Hamilton
Inertia
Optic

GRADE 2

Appoint Seating
Clyde
Dotty
Rush
Seed
Spin Seating
Whisper Vinyl

GRADE 3

In Season
Purl
Silvertex™ Vinyl

GRADE L

Denver Leather

For a complete list of fabrics, including partnership fabrics, go to hon.com/fabricsandfinishes.

Reference Fabric Color Combinations on pages 20-24 for color codes and legend on page 21 for lead times. For additional HON to Supply COM fabric grade pricing, go to honready.hon.com and click on the HON to Supply COM link.

⚠ For Fire Code model, availability and ordering method, refer to pages 28-31. Available on select models, contact HON Customer Support for availability.

CAMBIA™ 2160 Series

GSA SIN 711-18



Icon Legend on page 17

H2164



GUEST CHAIR

Upholstered Back
Leg Base
Arch Arms

DIMENSIONS

| | | | |
|--------------|-----|-----------------------|----------|
| Depth: | 24¼ | Arm Width: | 19 |
| Width: | 21¾ | Seat to Floor Height: | 19 |
| Height: | 31¾ | Usable Seat Depth: | 21 |
| Seat Depth: | 21 | Ship Weight: | 30 |
| Seat Width: | 21¾ | Cube: | 22.6 |
| Back Width: | 21¾ | COM: | 1.3 |
| Back Height: | 13¾ | Weight Rating: | 250 lbs. |

FABRIC PRICE CODES

| | | | |
|----------|--------------|-----------|---------------|
| 1 | \$587 | 8 | \$932 |
| 2 | \$647 | 9 | \$977 |
| 3 | \$707 | 10 | \$1022 |
| 4 | \$752 | 11 | \$1067 |
| 5 | \$797 | 12 | \$1112 |
| 6 | \$842 | L | \$1087 |
| 7 | \$887 | | |

H2165



GUEST CHAIR

Wood Slat Back
Leg Base
Arch Arms

DIMENSIONS

| | | | |
|--------------|-----|-----------------------|----------|
| Depth: | 24¼ | Arm Width: | 19 |
| Width: | 21¾ | Seat to Floor Height: | 19 |
| Height: | 31¾ | Usable Seat Depth: | 21 |
| Seat Depth: | 21 | Ship Weight: | 30 |
| Seat Width: | 21¾ | Cube: | 22.6 |
| Back Width: | 21¾ | COM: | 1.5 |
| Back Height: | 13¾ | Weight Rating: | 250 lbs. |

FABRIC PRICE CODES

| | | | |
|----------|--------------|-----------|--------------|
| 1 | \$619 | 8 | \$826 |
| 2 | \$655 | 9 | \$853 |
| 3 | \$691 | 10 | \$880 |
| 4 | \$718 | 11 | \$907 |
| 5 | \$745 | 12 | \$934 |
| 6 | \$772 | L | \$919 |
| 7 | \$799 | | |

HON Recommendation: H2164.MOCH.CU__ - List Price \$587

HOW TO SPECIFY

Select
Model Number

H 2 1 6 4 .

Select
Finish

See page 45

M O C H .

Select
Fabric

See page 45

C U 1 0 .



Task and Guest Chair shown with Announce® desks.

CERES®

Seating is personal. At the same time, it's also universal. Ceres is designed to bridge that gap by creating a holistic seating family that allows everyone to stay in control of their own comfort. As the result of exhaustive ergonomic research, the stunning Ceres collection of task and guest chairs feature total support for anyone and any space. The comfort contours cradle you throughout the workday, while projecting the right personality for your brand.



GUEST FEATURES

- ilira®-stretch mesh back is available in five colors.
- Model HCG6 is a four-leg multi-purpose chair with a pivoting back for added comfort.
- Model HCG6 stacks up to four high on the floor.
- Guest chairs are available with or without arms.
- Available in dual fabric.
- Warranted for users up to 300 lbs.

TASK CHAIR FEATURES

- Height- and width-adjustable arms provide a custom fit.
- Seat depth adjustment adapts to users of various heights.
- One-touch seat height adjustment easily moves the seat up and down.
- Tilt tension controls the rate and ease of recline.
- Tilt lock allows the user to lock out the tilt function.
- Warranted for users up to 300 lbs.

CERES® Task Chair Options



MODEL OPTION



HCW1





Task Chair

Pneumatic, Swivel, Synchro-tilt,
Seat Glide Tilt Tension, Height,
Width and Depth Adjustable Arms

| ARM STYLE | CODE | DESCRIPTION | PRICE |
|---|--------------|----------------------------|--------------|
|  | ABLCK | Textured Black | +\$0 |
|  | APLAT | Textured Platinum Metallic | +\$0 |
|  | APA | Polished Aluminum | +\$50 |

| CASTERS | CODE | DESCRIPTION | PRICE |
|--|----------|-------------|--------------|
|  | H | Hard Caster | +\$0 |
|  | S | Soft Caster | +\$30 |

| BACK STYLE | CODE | DESCRIPTION | PRICE |
|--|-----------|---------------------|-------------|
|  | PB | Upholstered in-back | +\$0 |
| <i>ilira®-stretch M4 options:</i> | | | |
|  | IM | Black | +\$0 |
| | IF | Fog | +\$0 |
| | IC | Charcoal | +\$0 |
| | IH | Chai | +\$0 |
| | IY | Navy | +\$0 |

| BASE | CODE | DESCRIPTION | PRICE |
|---|-----------|-------------------|---------------|
|  | SB | Standard Base | +\$0 |
|  | PA | Polished Aluminum | +\$110 |

| FRAME | CODE | DESCRIPTION | PRICE |
|-------|----------|-------------|-------------|
| | T | Black | +\$0 |

CERES® Multi-Purpose Chair Options

MODEL OPTION

HCG6



Multi-Purpose

Four-leg stacking frame
with pivoting back

HCG6DF - Dual Fabric



Multi-Purpose

Four-leg stacking frame
with pivoting back

ARM STYLE



| CODE | DESCRIPTION | PRICE |
|----------|-------------|-------------|
| N | Armless | +\$0 |



| | | |
|----------|------------|--------------|
| F | Fixed Arms | +\$55 |
|----------|------------|--------------|

CASTERS/ GLIDE



| CODE | DESCRIPTION | PRICE |
|----------|-------------|-------------|
| H | Hard Caster | +\$0 |



| | | |
|----------|-------------|--------------|
| S | Soft Caster | +\$20 |
|----------|-------------|--------------|



| | | |
|----------|-------|-------------|
| E | Glide | +\$0 |
|----------|-------|-------------|

BACK STYLE



| CODE | DESCRIPTION | PRICE |
|-----------|---------------------|-------------|
| PB | Upholstered in-back | +\$0 |



ilira®-stretch M4 options:

| | | |
|-----------|----------|-------------|
| IM | Black | +\$0 |
| IF | Fog | +\$0 |
| IC | Charcoal | +\$0 |
| IH | Chai | +\$0 |
| IY | Navy | +\$0 |

FRAME

| CODE | DESCRIPTION | PRICE |
|-------------|----------------------------|-------------|
| BLCK | Textured Black | +\$0 |
| PLAT | Textured Platinum Metallic | +\$0 |

CERES® Fabric Options

HON BRANDED FABRICS

GRADE 1

Attire
Centurion
Compass
Contourette Polyurethane
Dapper
Hamilton
Inertia
Optic

GRADE 2

Appoint Seating
Clyde
Dotty
Rush
Seed
Spin Seating
Whisper Vinyl

GRADE 3

In Season
Purl
Silvertex™ Vinyl

GRADE L

Denver Leather

For a complete list of fabrics, including partnership fabrics, go to hon.com/fabricsandfinishes.

Reference Fabric Color Combinations on pages 20-24 for color codes and legend on page 21 for lead times. For additional HON to Supply COM fabric grade pricing, go to honready.hon.com and click on the HON to Supply COM link.

 For Fire Code model, availability and ordering method, refer to pages 28-31. Available on select models, contact HON Customer Support for availability.



HCW1



TASK CHAIR

Pneumatic
Swivel
Synchro-tilt
Seat Glide Tilt Tension
Height, Width and Depth
Adjustable Arms
Functions:
A, D, E, A-C, A-D, B-A
(Function Key on pages 18-19)

DIMENSIONS

| | | | |
|--------------|--------|---------------------------------|----------|
| Depth: | 27¾ | Seat to Floor Height: | 17-21½ |
| Width: | 27½ | Usable Seat Depth: | 17-19½ |
| Height: | 43⅞ | Ship Weight (upholstered back): | 39 |
| Seat Depth: | 19 | Ship Weight (mesh back): | 39 |
| Seat Width: | 20 | Cube (upholstered back): | 11.3 |
| Back Width: | 16½ | Cube (mesh back): | 11.3 |
| Back Height: | 22½ | COM (upholstered back): | 1.0 |
| Arm Width: | 17½-21 | COM (mesh back): | 1.0 |
| | | Weight Rating: | 300 lbs. |

FABRIC PRICE CODES

| | | | |
|----------|---------------|-----------|---------------|
| 1 | \$1198 | 8 | \$1336 |
| 2 | \$1222 | 9 | \$1354 |
| 3 | \$1246 | 10 | \$1372 |
| 4 | \$1264 | 11 | \$1390 |
| 5 | \$1282 | 12 | \$1408 |
| 6 | \$1300 | L | \$1398 |
| 7 | \$1318 | | |

HON Recommendation: HCW1.ABLCK.H.IM.CU__SB.T - List Price \$1198

HOW TO SPECIFY

| Select Model Number | Select Arm Option | Select Caster/Glide | Select Back Option | Select Fabric | Select Base | Select Frame |
|---|---|--|--------------------|--|----------------|--------------|
| Adjustable Arms Finishes ABLCK Textured Black APLAT Textured Platinum Metallic APA Polished Aluminum (+ \$50) | H Hard Caster S Soft Caster (+ \$30) | PB Upholstered in-back Mesh Back Options IM Black IF Fog IC Charcoal IH Chai IY Navy | See page 50 | SB Standard Base PA Polished Aluminum (+ \$110) | T Black | |
| HCW1 | ABLCK | H | IM | CU10 | SB | T |



HCG6

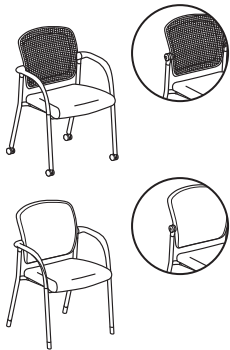

MULTI-PURPOSE

Four-leg stacking frame with pivoting back

DIMENSIONS

| | | | |
|--------------|-----|---------------------------------|----------|
| Depth: | 25 | Seat to Floor Height: | 18¾ |
| Width: | 24½ | Usable Seat Depth: | 17¼ |
| Height: | 35 | Ship Weight (upholstered back): | 22 |
| Seat Depth: | 19½ | Ship Weight (mesh back): | 22 |
| Seat Width: | 20 | Cube (upholstered back): | 15.2 |
| Back Width: | 17½ | Cube (mesh back): | 15.2 |
| Back Height: | 17 | COM (upholstered back): | 1.0 |
| Arm Width: | 20¼ | COM (mesh back): | 1.0 |
| | | Weight Rating: | 300 lbs. |

FABRIC PRICE CODES

| | | | |
|----------|--------------|-----------|--------------|
| 1 | \$523 | 8 | \$661 |
| 2 | \$547 | 9 | \$679 |
| 3 | \$571 | 10 | \$697 |
| 4 | \$589 | 11 | \$715 |
| 5 | \$607 | 12 | \$733 |
| 6 | \$625 | L | \$723 |
| 7 | \$643 | | |

NOTES: Multi-purpose model HCG6, with or without arms, stacks up to 4-high.

HON Recommendation: HCG6.F.H.IM.CU__BLCK - List Price \$578

HOW TO SPECIFY

| | | | | | |
|---|--|---|---|--|---|
| Select Model Number HCG6 | Select Arm Option F Fixed Arms (+ \$55) N Armless | Select Caster/Glide E Glide H Hard Caster S Soft Caster (+ \$20) | Select Back Option PB Upholstered in-back Mesh Back Options IM Black IF Fog IC Charcoal IH Chai IY Navy | Select Fabric See page 50 CU10 | Select Frame BLCK Textured Black PLAT Textured Platinum Metallic |
|---|--|---|---|--|---|

HCG6DF

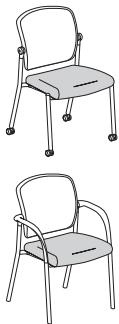

MULTI-PURPOSE

Dual Fabric
Four-leg stacking frame with pivoting back

DIMENSIONS

| | | | |
|--------------|-----|---------------------------------|----------|
| Depth: | 25 | Arm Width: | 20¼ |
| Width: | 24½ | Seat to Floor Height: | 18¾ |
| Height: | 35 | Usable Seat Depth: | 17¼ |
| Seat Depth: | 19½ | Ship Weight (upholstered back): | 22 |
| Seat Width: | 20 | Cube (upholstered back): | 15.2 |
| Back Width: | 17½ | COM (back): | 0.8 |
| Back Height: | 17 | COM (seat): | 1.0 |
| | | Weight Rating: | 300 lbs. |

FABRIC PRICE CODES

| | | |
|-----------|--------------------------------|--------------|
| 1 | \$598 | |
| | <i>Add to Base Price Above</i> | |
| | Back | Seat |
| 2 | \$18 | \$24 |
| 3 | \$36 | \$48 |
| 4 | \$50 | \$66 |
| 5 | \$63 | \$84 |
| 6 | \$77 | \$102 |
| 7 | \$90 | \$120 |
| 8 | \$104 | \$138 |
| 9 | \$117 | \$156 |
| 10 | \$131 | \$174 |
| 11 | \$144 | \$192 |
| 12 | \$158 | \$210 |
| L | \$150 | \$200 |

NOTES: Multi-purpose model HCG6DF, with or without arms, stacks up to 4-high.

HON Recommendation: HCG6DF.F.H.PB.CU__CU__BLCK - List Price \$695

HOW TO SPECIFY

| | | | | | | |
|---|--|---|--|---|---|---|
| Select Model Number HCG6DF | Select Arm Option F Fixed Arms (+ \$55) N Armless | Select Caster/Glide E Glide H Hard Caster S Soft Caster (+ \$20) | Select Back Option PB Upholstered in-back | Select Back Fabric See page 50 CU22 | Select Seat Fabric See page 50 CU10 | Select Frame BLCK Textured Black PLAT Textured Platinum Metallic |
|---|--|---|--|---|---|---|



HVL641



HIGH-BACK

- Pneumatic
- Swivel
- Tilt
- Tilt Tension
- Tilt Lock
- Loop Arms

Functions: **A, E, F, K, L, T**
(Function Key on pages 18-19)

DIMENSIONS

| | | | |
|--------------|-----|-----------------------|-------------|
| Depth: | 28½ | Arm Width: | 21⅞ |
| Width: | 25¾ | Seat to Floor Height: | 18⅞-21⅜ |
| Height: | 47 | Usable Seat Depth: | 20 |
| Seat Depth: | 20 | Ship Weight: | 43 Ⓢ |
| Seat Width: | 20½ | Cube: | 5.4 |
| Back Width: | 21 | Weight Rating: | 250 lbs. |
| Back Height: | 28½ | | |

PRICE CODE

Leather \$322

NOTES: Black SofThread™ Leather with pleated stitching detail. Black frame. Fixed loop arms. Use with coordinating Guest Chair model HVL643 shown below. **HON 5-Year Limited Warranty.**

HON Recommendation: HVL641.SB11 - List Price \$322

HVL643



GUEST CHAIR

- Leg Base
- Padded Arms

DIMENSIONS

| | | | |
|--------------|-----|-----------------------|---------------|
| Depth: | 28¼ | Arm Width: | 18½ |
| Width: | 24½ | Seat to Floor Height: | 19½ |
| Height: | 34½ | Usable Seat Depth: | 19½ |
| Seat Depth: | 19½ | Ship Weight: | 36.0 Ⓢ |
| Seat Width: | 19 | Cube: | 4.5 |
| Back Width: | 21¼ | Weight Rating: | 250 lbs. |
| Back Height: | 18 | | |

PRICE CODE

Leather \$264

NOTES: Black SofThread™ Leather with pleated stitching detail. Black frame. Use with coordinating Executive Chair model HVL641 shown above. **HON 5-Year Limited Warranty.**

HON Recommendation: HVL643.SB11 - List Price \$264

HOW TO SPECIFY

| | |
|-----------------------------------|---|
| <p>Select Model Number</p> | <p>Select Fabric</p> <p>SB11 Black SofThread™ Leather</p> |
| <p>H V L 6 4 1 .</p> | <p>S B 1 1</p> |



HVL871

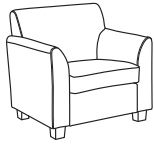

CLUB CHAIR

DIMENSIONS

| | | | |
|--------------|-----|-----------------------|----------|
| Depth: | 28¾ | Arm Width: | 21½ |
| Width: | 33 | Seat to Floor Height: | 18½ |
| Height: | 32 | Usable Seat Depth: | 21 |
| Seat Depth: | 21 | Ship Weight: | 51 |
| Seat Width: | 21½ | Cube: | 20.7 |
| Back Width: | 30 | Weight Rating: | 250 lbs. |
| Back Height: | 18½ | | |

PRICE CODE

Leather **\$993**

NOTES: Legs available in Black. Legs ship unattached. Available in SB11 SofThread™ Leather only. **HON 5-Year Limited Warranty.**

HON Recommendation: HVL871.SB11 - List Price \$993

HVL872

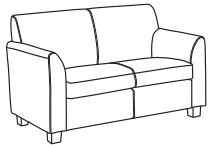

LOVE SEAT

DIMENSIONS

| | | | |
|--------------|-----|-----------------------|----------|
| Depth: | 28¾ | Arm Width: | 42 |
| Width: | 53½ | Seat to Floor Height: | 18½ |
| Height: | 32 | Usable Seat Depth: | 21 |
| Seat Depth: | 21 | Ship Weight: | 76 |
| Seat Width: | 42 | Cube: | 33.1 |
| Back Width: | 50 | Weight Rating: | 250 lbs. |
| Back Height: | 18½ | | |

PRICE CODE

Leather **\$1259**

NOTES: Legs available in Black. Legs ship unattached. Available in SB11 SofThread™ Leather only. **HON 5-Year Limited Warranty.**

HON Recommendation: HVL872.SB11 - List Price \$1259

HVL873

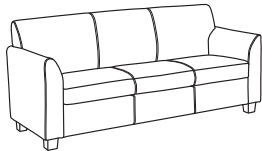

SOFA

DIMENSIONS

| | | | |
|--------------|-----|-----------------------|----------|
| Depth: | 28¾ | Arm Width: | 61½ |
| Width: | 73 | Seat to Floor Height: | 18½ |
| Height: | 32 | Usable Seat Depth: | 21 |
| Seat Depth: | 21 | Ship Weight: | 122 |
| Seat Width: | 61½ | Cube: | 45.0 |
| Back Width: | 70 | Weight Rating: | 250 lbs. |
| Back Height: | 18½ | | |

PRICE CODE

Leather **\$1573**

NOTES: Legs available in Black. Legs ship unattached. Available in SB11 SofThread™ Leather only. **HON 5-Year Limited Warranty.**

HON Recommendation: HVL873.SB11 - List Price \$1573

HOW TO SPECIFY

| | |
|-----------------------------------|--|
| <p>Select Model Number</p> | <p>Select Fabric</p> <p>SB11 Black SofThread™ Leather</p> |
| <p>H V L 8 7 1 .</p> | <p>S B 1 1</p> |



HVL691



HIGH-BACK

- Pneumatic
- Swivel
- Tilt
- Tilt Tension
- Tilt Lock
- Fixed Padded Arms

Functions: **A, E, F, K, L**
(Function Key on pages 18-19)

DIMENSIONS

| | | | |
|--------------|-----|-----------------------|-------------|
| Depth: | 28¾ | Arm Width: | 21 |
| Width: | 27 | Seat to Floor Height: | 18¾-21¾ |
| Height: | 47¼ | Usable Seat Depth: | 17¾ |
| Seat Depth: | 20¼ | Ship Weight: | 50 Ⓢ |
| Seat Width: | 21½ | Cube: | 7.2 |
| Back Width: | 21½ | Weight Rating: | 250 lbs. |
| Back Height: | 27 | | |

PRICE CODE

Leather \$454

NOTES: Black SofThread™ Leather. Sturdy textured black frame. Fixed padded loop arms. Built-in lumbar support. Use with coordinating Guest Chair model HVL693 shown below. **HON 5-Year Limited Warranty.**

HON Recommendation: HVL691.SB11 - List Price \$454

HVL693



GUEST CHAIR

- Sled Base
- Padded Arms

DIMENSIONS

| | | | |
|--------------|-----|-----------------------|---------------|
| Depth: | 26 | Arm Width: | 18½ |
| Width: | 24¾ | Seat to Floor Height: | 18¼ |
| Height: | 33½ | Usable Seat Depth: | 18¼ |
| Seat Depth: | 18¼ | Ship Weight: | 38.0 Ⓢ |
| Seat Width: | 20¾ | Cube: | 5.2 |
| Back Width: | 21 | Weight Rating: | 250 lbs. |
| Back Height: | 16¼ | | |

PRICE CODE

Leather \$294

NOTES: Black SofThread™ Leather with tailored stitching detail. Sturdy textured black frame. Built-in lumbar support. Use with coordinating Executive Chair model HVL691 shown above. **HON 5-Year Limited Warranty.**

HON Recommendation: HVL693.SB11 - List Price \$294

HOW TO SPECIFY

| | |
|-----------------------------------|---|
| <p>Select Model Number</p> | <p>Select Fabric</p> <p>SB11 Black SofThread™ Leather</p> |
| <p>H V L 6 9 1 .</p> | <p>S B 1 1</p> |

COMFORTASK® 5900 SERIES



ComforTask Chair shown
with Metro Classic desks.

COMFORTASK® 5900 SERIES

What's in a name? If it's ComforTask, is the support you need to get the job done. ComforTask seating is a proven office performer, with cushioning in all the right places, a waterfall seat edge and the customizable comfort that allows everyone to create a personal fit. Advanced controls such as back height and seat depth adjustments take the personalization to an even higher level, earning fans throughout the office.



FEATURES

- Back height adjustment moves the back up or down to provide a custom fit.
- Seat depth adjustment on Model H5901 adapts to users of various heights.
- Contoured seat and back provide targeted support.
- Waterfall seat edge encourages leg circulation.
- One-touch seat height adjustment easily moves the seat up and down.
- 360-degree swivel provides freedom of movement in any direction.
- Molded polymer outer back.
- Model H5905 is available with optional bell glides.
- Available in hundreds of quality HON fabrics.
- Warranted for users up to 300 lbs.

COMFORTASK® 5900 Series Options

MODEL OPTIONS

H5901



Task Chair

Pneumatic, Back Height, Seat Depth, Swivel

H5902



Task Chair

Pneumatic, Back Height, Swivel, Tilt, Tilt Tension, Tilt Lock

H5903



Task Chair

Pneumatic, Back Height, Swivel, Multi-task

H5905



Task Stool

Pneumatic, Back Height, Swivel, Adjustable Height Footring

CASTERS/ GLIDE



| CODE | DESCRIPTION | PRICE |
|----------|-------------|-------------|
| H | Hard Caster | +\$0 |



| | | |
|----------|-------------|--------------|
| S | Soft Caster | +\$30 |
|----------|-------------|--------------|



| | | |
|----------|------------|--------------|
| G | Bell Glide | +\$25 |
|----------|------------|--------------|

*G only available on model H5905

FRAME

| CODE | DESCRIPTION | PRICE |
|----------|-------------|-------------|
| T | Black | +\$0 |

COMFORTASK®

5900 Series Fabric Options

HON BRANDED FABRICS

GRADE 1

Attire
Centurion
Compass
Contourette Polyurethane
Dapper
Hamilton
Inertia
Optic

GRADE 2

Appoint Seating
Clyde
Dotty
Rush
Seed
Spin Seating
Whisper Vinyl

GRADE 3

In Season
Purl
Silvertex™ Vinyl

For a complete list of fabrics, including partnership fabrics, go to hon.com/fabricsandfinishes.

Reference Fabric Color Combinations on pages 20-24 for color codes and legend on page 21 for lead times. COM yardage shown is for Pattern Cut only. Contact Customer Service for Railroaded yardage requirements. For additional HON to Supply COM fabric grade pricing, go to honready.hon.com and click on the HON to Supply COM link.

 For Fire Code model, availability and ordering method, refer to pages 28-31. Available on select models, contact HON Customer Support for availability.



Icon Legend on page 17

COMFORTASK® 5900 Series

H5901



TASK

Pneumatic
Back Height
Seat Depth
Swivel
Functions: **A, B, C, E**
(Function Key on pages 18-19)

NOTES: Seat depth adjustment.

DIMENSIONS

Depth: 28¾" Seat to Floor Height: 14⅞"-19¾"
Width: 23" Usable Seat Depth: 16⅝"-18⅞"
Height: 38¾" Ship Weight: 30 Ⓢ
Seat Depth: 18" Cube: 7.8
Seat Width: 20" COM: 1.0
Back Width: 16¼" Weight Rating: 300 lbs.
Back Height: 17¾"

FABRIC PRICE CODES

| | | | |
|---|-------|----|-------|
| 1 | \$273 | 8 | \$411 |
| 2 | \$297 | 9 | \$429 |
| 3 | \$321 | 10 | \$447 |
| 4 | \$339 | 11 | \$465 |
| 5 | \$357 | 12 | \$483 |
| 6 | \$375 | L | — |
| 7 | \$393 | | |

H5902



TASK

Pneumatic
Back Height
Swivel
Tilt
Tilt Tension
Tilt Lock
Functions: **A, B, E, F, K, L**
(Function Key on pages 18-19)

DIMENSIONS

Depth: 27¾" Seat to Floor Height: 17-22"
Width: 23" Usable Seat Depth: 16¾"
Height: 39¾" Ship Weight: 30 Ⓢ
Seat Depth: 18" Cube: 7.8
Seat Width: 20" COM: 1.0
Back Width: 16¼" Weight Rating: 300 lbs.
Back Height: 21"

FABRIC PRICE CODES

| | | | |
|---|-------|----|-------|
| 1 | \$291 | 8 | \$429 |
| 2 | \$315 | 9 | \$447 |
| 3 | \$339 | 10 | \$465 |
| 4 | \$357 | 11 | \$483 |
| 5 | \$375 | 12 | \$501 |
| 6 | \$393 | L | — |
| 7 | \$411 | | |

H5903



TASK

Pneumatic
Back Height
Swivel
Multi-task
Functions: **A, B, E, N**
(Function Key on pages 18-19)

DIMENSIONS

Depth: 34¼" Seat to Floor Height: 16¼"-20⅞"
Width: 24" Usable Seat Depth: 13¾"-17"
Height: 40½" Ship Weight: 32 Ⓢ
Seat Depth: 18" Cube: 7.8
Seat Width: 20" COM: 1.0
Back Width: 16¼" Weight Rating: 300 lbs.
Back Height: 20¼"

FABRIC PRICE CODES

| | | | |
|---|-------|----|-------|
| 1 | \$411 | 8 | \$549 |
| 2 | \$435 | 9 | \$567 |
| 3 | \$459 | 10 | \$585 |
| 4 | \$477 | 11 | \$603 |
| 5 | \$495 | 12 | \$621 |
| 6 | \$513 | L | — |
| 7 | \$531 | | |

HON Recommendation: H5901.H.CU__T with optional H5995 - List Price \$378

HOW TO SPECIFY

| | | | |
|--|--|---|--|
| <p>Select Model Number</p> <p>H 5 9 0 1 .</p> | <p>Select Caster/Glide</p> <p>H Hard Caster S Soft Caster (+ \$30)</p> <p>H .</p> | <p>Select Fabric</p> <p>See page 58</p> <p>C U 1 0 .</p> | <p>Select Frame</p> <p>T Black</p> <p>T</p> |
|--|--|---|--|

COMFORTASK® 5900 Series

GSA SIN 711-18



Icon Legend on page 17

H5905



TASK STOOL

Pneumatic
Back Height
Swivel
Adjustable Height Footring
Functions: **A, B, E**
(Function Key on pages 18-19)

DIMENSIONS

| | | | |
|--------------|--------------------------------|-----------------------|--|
| Depth: | 30 | Seat to Floor Height: | 21 ³ / ₄ -31 ¹ / ₈ |
| Width: | 26 ³ / ₄ | Footring Width: | 20 |
| Height: | 49 ³ / ₄ | Footring Height: | 12-14 ¹ / ₂ |
| Seat Depth: | 18 | Usable Seat Depth: | 17 |
| Seat Width: | 20 | Ship Weight: | 34 Ⓢ |
| Back Width: | 16 ¹ / ₄ | Cube: | 10.4 |
| Back Height: | 17 ³ / ₄ | COM: | 1.0 |
| | | Weight Rating: | 300 lbs. |

FABRIC PRICE CODES

| | | | |
|----------|--------------|-----------|--------------|
| 1 | \$398 | 8 | \$536 |
| 2 | \$422 | 9 | \$554 |
| 3 | \$446 | 10 | \$572 |
| 4 | \$464 | 11 | \$590 |
| 5 | \$482 | 12 | \$608 |
| 6 | \$500 | L | — |
| 7 | \$518 | | |

NOTES: Available with optional Bell Glides.

H5991



T-ARMS

Fixed Position

DIMENSIONS

| | |
|-------------------|--------------------------------|
| Arm Width: | 18 ³ / ₄ |
| Height from Seat: | 8 ¹ / ₂ |
| Ship Weight: | 6 Ⓢ |
| Cube: | 1.0 |

LIST PRICE

\$74

H5995



ADJUSTABLE HEIGHT ARMS

Functions: **Q**
(Function Key on pages 18-19)

DIMENSIONS

| | |
|-------------------|--|
| Arm Width: | 18 ³ / ₄ |
| Height from Seat: | 6 ¹ / ₂ -8 ³ / ₄ |
| Ship Weight: | 8 Ⓢ |
| Cube: | 0.6 |

LIST PRICE

\$105

HOW TO SPECIFY

| | | | |
|---|--|--|---------------------------------------|
| Select Model Number <div style="border: 1px solid black; display: flex; justify-content: space-between; padding: 2px;"> H5905 </div> | Select Caster/Glide H Hard Caster S Soft Caster (+ \$30) <i>Specify for model H5905 only</i> G Bell Glide (+ \$25) | Select Fabric See page 58 <div style="border: 1px solid black; display: flex; justify-content: space-between; padding: 2px;"> CU10 </div> | Select Frame T Black |
|---|--|--|---------------------------------------|

NOTES

CONVERA™ LOUNGE



Convera Club Chairs and Love Seat shown with Endorse Tables.

CONVERA™ LOUNGE

Make a strong impression in any reception area, lounge, or private office with Convera lounge seating. Enjoy a tailored fit. Graceful lines. Inspired design. The fully-upholstered seat and back features accent piping and solid hardwood legs to make a stylish statement. Choose from a wide selection of fabrics to create a look that reflects your unique tastes. Convera is the lounge chair family that guests at ease, while putting you in total control of the look of your work environment.



FEATURES

- Contoured seat, back and arms create a softer feel.
- Solid hardwood legs in one of eight attractive finishes.
- Nylon glides slide effortlessly on all surfaces.
- Available in hundreds of quality HON fabrics.
- Warranted for users up to 250 lbs.

CONVERA™ Lounge Options

MODEL OPTIONS

HDAC01



Club Chair

Fully-Upholstered

HDAA01

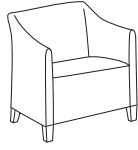

Lounge Chair

Fully-Upholstered

HDAL02

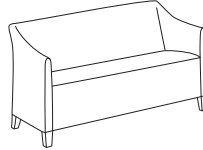

Love Seat

Fully-Upholstered

AVAILABLE FINISHES

Convera™ Lounge Seating is available in 8 wood finishes.

WOOD FINISHES

Bourbon Cherry (H)

Cognac (COGN)

Harvest (C)

Mahogany (N)

Mocha (MOCH)

Natural Maple (D)

Pinnacle (PINC)

Shaker Cherry (F)

HON BRANDED FABRICS

GRADE 1

Centurion
Compass
Contourette Polyurethane
Dapper
Hamilton
Inertia
Optic

GRADE 2

Appoint Seating
Clyde
Rush
Seed
Spin Seating
Whisper Vinyl

GRADE 3

Purl
Silvertex™ Vinyl

GRADE L

Denver Leather

For a complete list of fabrics, including partnership fabrics, go to hon.com/fabricsandfinishes.

Reference Fabric Color Combinations on pages 20-24 for color codes and legend on page 21 for lead times. For additional HON to Supply COM fabric grade pricing, go to honready.hon.com and click on the HON to Supply COM link.

🔥 For Fire Code model, availability and ordering method, refer to pages 28-31. Available on select models, contact HON Customer Support for availability.



Icon Legend on page 17

CONVERA™ Lounge

HDAC01



CLUB CHAIR

Fully-Upholstered

DIMENSIONS

| | | | |
|--------------|--------------------------------|-----------------------|--------------------------------|
| Depth: | 27 ³ / ₈ | Arm Width: | 18 ³ / ₄ |
| Width: | 24 | Seat to Floor Height: | 18 ³ / ₄ |
| Height: | 32 ³ / ₄ | Usable Seat Depth: | 17 ³ / ₄ |
| Seat Depth: | 17 ³ / ₄ | Ship Weight: | 43 |
| Seat Width: | 17 ³ / ₄ | Cube: | 15.1 |
| Back Width: | 17 ³ / ₄ | COM: | 3.5 |
| Back Height: | 15 ¹ / ₂ | Weight Rating: | 250 lbs. |

FABRIC PRICE CODES

| | | | |
|---|--------|----|--------|
| 1 | \$1684 | 8 | \$2167 |
| 2 | \$1768 | 9 | \$2230 |
| 3 | \$1852 | 10 | \$2293 |
| 4 | \$1915 | 11 | \$2356 |
| 5 | \$1978 | 12 | \$2419 |
| 6 | \$2041 | L | \$2384 |
| 7 | \$2104 | | |

HDAA01



LOUNGE CHAIR

Fully-Upholstered

DIMENSIONS

| | | | |
|--------------|--------------------------------|-----------------------|--------------------------------|
| Depth: | 30 ³ / ₄ | Arm Width: | 22 ¹ / ₂ |
| Width: | 29 | Seat to Floor Height: | 17 |
| Height: | 30 ³ / ₄ | Usable Seat Depth: | 19 ³ / ₄ |
| Seat Depth: | 19 ³ / ₄ | Ship Weight: | 56 |
| Seat Width: | 21 ¹ / ₂ | Cube: | 20.7 |
| Back Width: | 21 ¹ / ₄ | COM: | 4.5 |
| Back Height: | 17 ¹ / ₂ | Weight Rating: | 250 lbs. |

FABRIC PRICE CODES

| | | | |
|---|--------|----|--------|
| 1 | \$1828 | 8 | \$2449 |
| 2 | \$1936 | 9 | \$2530 |
| 3 | \$2044 | 10 | \$2611 |
| 4 | \$2125 | 11 | \$2692 |
| 5 | \$2206 | 12 | \$2773 |
| 6 | \$2287 | L | \$2728 |
| 7 | \$2368 | | |

HDAL02

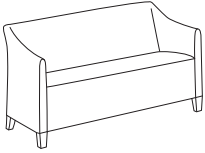

LOVE SEAT

Fully-Upholstered

DIMENSIONS

| | | | |
|--------------|--------------------------------|-----------------------|--------------------------------|
| Depth: | 30 ³ / ₄ | Arm Width: | 46 ³ / ₄ |
| Width: | 53 ³ / ₄ | Seat to Floor Height: | 17 |
| Height: | 30 ¹ / ₂ | Usable Seat Depth: | 19 ³ / ₄ |
| Seat Depth: | 19 ³ / ₄ | Ship Weight: | 85 |
| Seat Width: | 45 ³ / ₄ | Cube: | 58.4 |
| Back Width: | 45 ¹ / ₂ | COM: | 6.0 |
| Back Height: | 17 ¹ / ₂ | Weight Rating: | 250 lbs. |

FABRIC PRICE CODES

| | | | |
|---|--------|----|--------|
| 1 | \$2469 | 8 | \$3297 |
| 2 | \$2613 | 9 | \$3405 |
| 3 | \$2757 | 10 | \$3513 |
| 4 | \$2865 | 11 | \$3621 |
| 5 | \$2973 | 12 | \$3729 |
| 6 | \$3081 | L | \$3669 |
| 7 | \$3189 | | |

HON Recommendation: HDAC01.MOCH.PNS__ - List Price \$1768

HOW TO SPECIFY

| | | |
|---|--|--|
| <p>Select Model Number</p> <p>HDAC01</p> | <p>Select Leg Finish</p> <p>See page 64</p> <p>MOCH</p> | <p>Select Fabric</p> <p>See page 64</p> <p>PNS007</p> |
|---|--|--|

CONVERGENCE®



Convergence Task Chairs shown with Empower® Benching.

CONVERGENCE®

What happens when support and affordability come together? Convergence. This is the task chair that is as attainable as it is comfortable with customizable features. Lumbar support that adds a little extra lower back comfort. Thick seat cushions to take the stress off the lower body throughout the day. Arm choices that let you decide how much upper body support you want. A breathable mesh back that flexes and responds to your movements. Convergence puts all the features you're looking for into one low-priced task chair.



FEATURES

- Choice of swivel tilt or synchro-tilt control with seat slide.
- Black mesh back is breathable for all-day comfort and support.
- Comfort options include adjustable lumbar support, adjustable arms, seat glide and synchro-tilt.
- Three arm options.
- Two control options.
- Integrated handle on the back makes it easy to move and reposition the chair.
- Hard casters move effortlessly on any surface.
- Black frame sits atop a durable five-star base.
- Warranted for users up to 275 lbs.
- 3" thick seat cushion.







BACK OPTIONS

HCT1MM

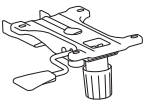

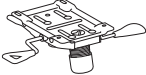
Mid-back

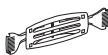
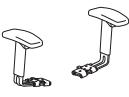
Mesh Task Chair
with Adjustable
Lumbar Support

| MECHANISM | | | | BACK STYLE | | | |
|---|-----------|---|--------------|---|-----------|-------------------|-------------|
| | CODE | FUNCTIONS | PRICE | | CODE | DESCRIPTION | PRICE |
|  | ZI | Swivel-Tilt Control A, E, F, K, L, W | +\$0 |  | M | Mesh | +\$0 |
|  | YI | Limited Synchro-Tilt A, D, E, J, K, L, W | +\$35 | | | | |
| (See pages 18-19 for Seating Functions.) | | | | BASE | | | |
| | CODE | DESCRIPTION | PRICE | | CODE | DESCRIPTION | PRICE |
| | SB | Standard Base | +\$0 |  | | | |
| ARM STYLE | | | | LUMBAR | | | |
| | CODE | DESCRIPTION | PRICE | | CODE | DESCRIPTION | PRICE |
|  | N | Armless | +\$0 |  | AL | Adjustable Lumbar | +\$0 |
|  | H | Height Adjustable Arms | +\$45 | | | | |
|  | A | Height and Width Adjustable Arms | +\$50 | FRAME | | | |
| | CODE | DESCRIPTION | PRICE | | CODE | DESCRIPTION | PRICE |
| | T | Black | +\$0 | | | | |
| CASTERS | | | | | | | |
| | CODE | DESCRIPTION | PRICE | | | | |
|  | H | Hard Casters | +\$0 | | | | |

CONVERGENCE®

Fabric Options

HON BRANDED FABRICS

GRADE 1

Attire
Centurion
Compass
Contourette Polyurethane
Dapper
Hamilton
Inertia
Optic

GRADE 2

Appoint Seating
Dotty
Rush
Whisper Vinyl

GRADE 3

In Season
Purl
Silvertex™ Vinyl

For a complete list of fabrics, including partnership fabrics, go to hon.com/fabricsandfinishes.

Reference Fabric Color Combinations on pages 20-24 for color codes and legend on page 21 for lead times. For additional HON to Supply COM fabric grade pricing, go to honready.hon.com and click on the HON to Supply COM link.



Icon Legend on page 17

CONVERGENCE[®] Task Chairs

HCT1MM



MID-BACK TASK

Mesh Back

- Pneumatic
- Swivel
- Tilt Tension
- Tilt Lock
- Adjustable Lumbar Support

Functions: **A, E, K, L, W**
(Function Key on pages 18-19)

DIMENSIONS

| | | | |
|--------------|-----|------------------------|----------|
| Depth: | 27½ | Adjustable Arms Width: | 20 |
| Width: | 27¾ | Seat to Floor Height: | 15¾-20 |
| Height: | 42 | Usable Seat Depth: | 17-19 |
| Seat Depth: | 19 | Ship Weight: | 44 |
| Seat Width: | 20 | Cube: | 5.8 |
| Back Width: | 18 | COM: | 1.0 |
| Back Height: | 22 | Weight Rating: | 275 lbs. |

FABRIC PRICE CODES

| | | | |
|----------|--------------|-----------|--------------|
| 1 | \$288 | 7 | \$348 |
| 2 | \$300 | 8 | \$357 |
| 3 | \$312 | 9 | \$366 |
| 4 | \$321 | 10 | \$375 |
| 5 | \$330 | 11 | \$384 |
| 6 | \$339 | 12 | \$393 |

NOTES: Arm width adjustment range is 3" (from 17"-20"). Lumbar adjustment is 3". Seat depth range is only for Y1 control. Seat depth on Z1 control is 19".

HON Recommendation: HCT1MM.Y1.A.H.M.CU10.AL.SB.T - List Price \$373

HOW TO SPECIFY

| Select Model Number | Select Control Type | Select Arm Type | Select Caster | Select Back Type | Select Upholstery | Select Lumbar | Select Base | Select Frame |
|---------------------|---|--|-----------------------|------------------|-------------------|-----------------------------|-------------------------|----------------|
| | Z1 Swivel-tilt Control Y1 Simple Synchro-tilt w/ Seat Slide Control (+ \$35) | N Armless H Height Adjustable Arms (+ \$45) A Height & Width Adjustable Arms (+ \$50) | H Hard Casters | M Mesh | See page 68 | AL Adjustable Lumbar | SB Standard Base | T Black |
| HCT1MM | Y1 | A | H | M | CU10 | AL | SB | T |

CONVERGENCE® Task Chairs

OPEN MARKET



Icon Legend on page 17

HCAT1MM



MID-BACK TASK VALUE MODEL

- Mesh Back**
- Pneumatic
- Swivel
- Tilt Tension
- Tilt Lock
- Adjustable Lumbar Support

Functions: **A, E, K, L, W**
(Function Key on pages 18-19)

NOTES: Lumbar adjustment is 3". Seat depth range is only for Y1 control. Seat depth on Z1 control is 19".

DIMENSIONS

| | | | |
|--------------|-----|------------------------|----------|
| Depth: | 27½ | Adjustable Arms Width: | 17-20 |
| Width: | 27¾ | Seat to Floor Height: | 15¾-20 |
| Height: | 42 | Usable Seat Depth: | 17-19 |
| Seat Depth: | 19 | Ship Weight: | 44 |
| Seat Width: | 20 | Cube: | 5.8 |
| Back Width: | 18 | Weight Rating: | 275 lbs. |
| Back Height: | 22 | | |

LIST PRICE

\$304

HON Recommendation: HCAT1MM.Z1.A.H.M.ACCF10.AL.SB.T - List Price \$304

HOW TO SPECIFY

| Select Model Number | Select Control Type | Select Arm Type | Select Caster | Select Back Type | Select Upholstery | Select Lumbar | Select Base | Select Frame |
|---|----------------------------------|-----------------|---------------|------------------|----------------------|------------------|-------------|--------------|
| Z1 Swivel-tilt Control Y1 Simple Synchro-tilt w/ Seat Slide Control (+ \$35) | A Height & Width Adjustable Arms | H Hard Casters | M Mesh | ACCF10 Black | AL Adjustable Lumbar | SB Standard Base | T Black | |
| HCAT1MM | Y1 | A | H | M | ACCF10 | AL | SB | T |



Icon Legend on page 17

CORRAL™ Contemporary Lounge

HVL887

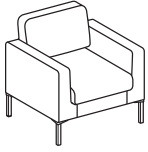

CLUB CHAIR

DIMENSIONS

| | | | |
|--------------|-----|-----------------------|-------------|
| Depth: | 28 | Arm Width: | 22¼ |
| Width: | 31½ | Seat to Floor Height: | 17⅞ |
| Height: | 30½ | Usable Seat Depth: | 19¾ |
| Seat Depth: | 19¾ | Ship Weight: | 51 Ⓢ |
| Seat Width: | 22¼ | Cube: | 8.9 |
| Back Width: | 22¼ | Weight Rating: | 250 lbs. |
| Back Height: | 17½ | | |

PRICE CODE

Leather \$772

NOTES: Legs available in Platinum. Legs and back ship unattached. Pair with contemporary occasional tables on page 72. **HON 5-Year Limited Warranty.**

! Available in SB11 SofThread™ Leather only.

HON Recommendation: HVL887.SB11 - List Price \$772

HVL888

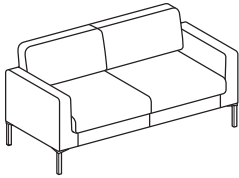

SOFA

DIMENSIONS

| | | | |
|--------------|-----|-----------------------|----------|
| Depth: | 28 | Arm Width: | 55 |
| Width: | 67 | Seat to Floor Height: | 17⅞ |
| Height: | 30½ | Usable Seat Depth: | 19¾ |
| Seat Depth: | 19¾ | Ship Weight: | 78 |
| Seat Width: | 55 | Cube: | 18.3 |
| Back Width: | 55 | Weight Rating: | 250 lbs. |
| Back Height: | 17½ | | |

PRICE CODE

Leather \$987

NOTES: Legs available in Platinum. Legs and back ship unattached. Pair with contemporary occasional tables on page 72. **HON 5-Year Limited Warranty.**

! Available in SB11 SofThread™ Leather only.

HON Recommendation: HVL888.SB11 - List Price \$987

HOW TO SPECIFY

Select Model Number

Select Fabric

SB11 Black SofThread™ Leather

H V L 8 8 7 .

S B 1 1

CONTEMPORARY OCCASIONAL TABLES

OPEN MARKET



Icon Legend on page 17

HML8851

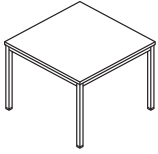

LAMINATE CORNER TABLE DIMENSIONS

| | | | |
|--------|----|--------------|------|
| Depth: | 24 | Ship Weight: | 24 Ⓢ |
| Width: | 24 | Cube: | 1.7 |

LIST PRICE

\$155

NOTES: Metal leg occasional tables available in Chestnut or Black laminate. Choose from Corner or Coffee Table options. **HON 5-Year Limited Warranty.**

HON Recommendation: HML8851.P - List Price \$155

HML8852

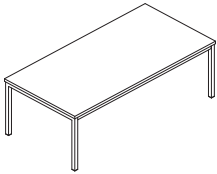

LAMINATE COFFEE TABLE DIMENSIONS

| | | | |
|--------|----|--------------|------|
| Depth: | 24 | Ship Weight: | 38 Ⓢ |
| Width: | 48 | Cube: | 3.1 |

LIST PRICE

\$196

NOTES: Metal leg occasional tables available in Chestnut or Black laminate. Choose from Corner or Coffee Table options. **HON 5-Year Limited Warranty.**

HON Recommendation: HML8852.P - List Price \$196

HOW TO SPECIFY

| | |
|--|--|
| Select Model Number <div style="border: 1px solid #ccc; display: flex; justify-content: space-between; padding: 2px;"> HML8851 </div> | Select Laminate P Black C1 Chestnut |
| <div style="border: 1px solid #ccc; display: flex; justify-content: space-between; padding: 2px;"> HML8851 </div> | <div style="border: 1px solid #ccc; display: flex; justify-content: space-between; padding: 2px;"> P </div> |



HVL581



HIGH-BACK

Pneumatic
Swivel
Tilt
Tilt Tension
Tilt Lock
Height and Width Adjustable
Arms
Adjustable Lumbar

Functions: **A, E, F, K, L, S, W**
(Function Key on pages 18-19)

NOTES: Comfortable and breathable mesh back. Black fabric or Black SofThread™ Leather. Black frame. Height and width adjustable arms. Adjustable lumbar. **HON 5-Year Limited Warranty.**

HON Recommendation: HVL581.ES10.T - List Price \$288

DIMENSIONS

| | | | |
|-------------|-----|-----------------------|---------------|
| Depth: | 25½ | Arm Width: | 19⅞ |
| Width: | 28¾ | Seat to Floor Height: | 16½-20¼ |
| Height: | 42⅞ | Usable Seat Depth: | 17¼ |
| Seat Depth: | 17¼ | Ship Weight: | 39.8 Ⓢ |
| Seat Width: | 20¼ | Cube: | 4.8 |
| Back Width: | 18½ | Weight Rating: | 250 lbs. |

PRICE CODE

| | |
|----------------|--------------|
| Fabric | \$288 |
| Leather | \$313 |

HVL582



HIGH-BACK

Pneumatic
Swivel
Tilt
Tilt Tension
Tilt Lock
Asynchronous Control
Seat Glide Mechanism
Adjustable Lumbar
Height and Width Adjustable
Arms

Functions: **A, E, F, L, O, S, W**
(Function Key on pages 18-19)

NOTES: Comfortable and breathable mesh back. Black fabric or Black SofThread™ Leather. Black frame. Height and width adjustable arms. Seat glide mechanism. Asynchronous control with independent seat and back angle adjustment. Adjustable lumbar. **HON 5-Year Limited Warranty.**

HON Recommendation: HVL582.ES10.T - List Price \$354

DIMENSIONS

| | | | |
|-------------|-----|-----------------------|---------------|
| Depth: | 27½ | Arm Width: | 19⅞ |
| Width: | 28¾ | Seat to Floor Height: | 20½-22⅞ |
| Height: | 43¾ | Usable Seat Depth: | 17¼ |
| Seat Depth: | 17¼ | Ship Weight: | 50.4 Ⓢ |
| Seat Width: | 19⅞ | Cube: | 6.8 |
| Back Width: | 18½ | Weight Rating: | 250 lbs. |

PRICE CODE

| | |
|----------------|--------------|
| Fabric | \$354 |
| Leather | \$379 |

HVL585



EXECUTIVE BIG AND TALL

Pneumatic
Swivel
Tilt
Tilt Tension
Tilt Lock
Height and Width Adjustable
Arms
Adjustable Lumbar

Functions: **A, E, F, K, L, S, W**
(Function Key on pages 18-19)

NOTES: Large scale model HVL585 will support 450 lbs with normal use. Black fabric or Black SofThread™ Leather. Black frame. Height and width adjustable arms. Adjustable lumbar. **HON 5-Year Limited Warranty.**

HON Recommendation: HVL585.ES10.T - List Price \$500

DIMENSIONS

| | | | |
|-------------|-----|-----------------------|---------------|
| Depth: | 29⅞ | Arm Width: | 20½ |
| Width: | 28⅞ | Seat to Floor Height: | 17⅞-21¾ |
| Height: | 45⅞ | Usable Seat Depth: | 19⅞ |
| Seat Depth: | 19⅞ | Ship Weight: | 55.4 Ⓢ |
| Seat Width: | 22 | Cube: | 7.2 |
| Back Width: | 20⅞ | Weight Rating: | 450 lbs. |

PRICE CODE

| | |
|----------------|--------------|
| Fabric | \$500 |
| Leather | \$525 |

HOW TO SPECIFY

| | | |
|--|--|--|
| <p>Select Model Number</p> <p>H V L 5 8 1</p> | <p>Select Fabric</p> <p>ES10 Black SB11 Black SofThread™ Leather</p> <p>E S 1 0</p> | <p>Select Frame</p> <p>T Black</p> <p>T</p> |
|--|--|--|

DEFINE™ Executive Chairs

OPEN MARKET



Icon Legend on page 17

HVL108



HIGH-BACK

Pneumatic
Swivel
Synchro-tilt
Height-adjustable Arms
Functions: **A, E, J, K, Q**
(Function Key on pages 18-19)

DIMENSIONS

| | | | |
|--------------|-----|-----------------------|---------------|
| Depth: | 29¾ | Arm Width: | 19½ |
| Width: | 29¾ | Seat to Floor Height: | 17⅞-21⅜ |
| Height: | 46⅞ | Usable Seat Depth: | 17½ |
| Seat Depth: | 17½ | Ship Weight: | 47.3 Ⓢ |
| Seat Width: | 21 | Cube: | 7.2 |
| Back Width: | 20 | Weight Rating: | 250 lbs. |
| Back Height: | 26½ | | |

PRICE CODE

Leather **\$445**

NOTES: Available in Black and Brown SofThread™ Leather. Polished chrome base. Polished arm accents. Height-adjustable arms. **HON 5-Year Limited Warranty.**

HON Recommendation: HVL108.SB11 - List Price \$445

HOW TO SPECIFY

Select
Model Number

H V L 1 0 8 .

Select
Fabric

SB11 Black SofThread™ Leather
SB45 Brown SofThread™ Leather

S B 1 1

ENDORSE® COLLECTION



Endorse Executive Mid-Back Chair shown with Preside® Conference Table.

ENDORSE® COLLECTION

You need inviting, comfy seats up front, and task chairs that support productivity in workstations. Achieve harmony throughout your space with a multi-functional collection of Endorse task and lounge seating. Endorse supports the diversity of applications throughout your workplace with sophisticated design. Varied options. Diverse materials. Simply pick the model that suits your space and people. Add the options or coordinating occasional tables that fit your needs. Then get ready to Endorse a higher level of productivity.



TASK CHAIR FEATURES

- Available in high-, mid- and low-back options.
- Available in three different back materials — upholstered, mesh and plastic outer back.
- Comfort options include adjustable lumbar support, adjustable arms, seat glide, multi-position tilt and synchro-tilt.
- Optional seat slide adjustment adapts to users of various heights.
- Control options include limited synchro-tilt, advanced synchro-tilt, advanced synchro-tilt with independent back angle and weight-activated control.
- Arm options include fixed, armless, height- and width-adjustable and all-adjustable.
- Caster options include hard, soft and roll-control.
- Available in hundreds of quality HON fabrics.
- Warranted for users up to 300 lbs.
(450 lbs. for Big and Tall chairs)



LOUNGE SEATING

- Choose from Single Seat, Two-Seat or Three-Seat options.
- Durable steel frame construction.
- Available in hundreds of quality HON fabrics.
- Warranted for users up to 300 lbs.



OCCASIONAL TABLES

- Available in Square or Rectangular tops.
- Available in eight top laminate finishes.
- Available in ten edgeband laminate finishes.
- Optional integrated power grommets.

ENDORSE® Options

BACK OPTIONS

HLEU
HLEUBT - Big & Tall



High-back

Upholstered with Adjustable Lumbar Support

HLWU
HLWUBT - Big & Tall



Mid-back

Upholstered with Adjustable Lumbar Support

HLWM
HLWMBT - Big & Tall

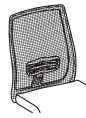

Mid-back

Mesh with Adjustable Lumbar Support

HLTU
HLTSU - Stool



Low-back

Upholstered with Adjustable Lumbar Support

HLTM
HLTSM - Stool



Low-back

Mesh with Adjustable Lumbar Support

HLTP
HLTSP - Stool







Low-back

Upholstered with Plastic Outer Back and Adjustable Lumbar Support

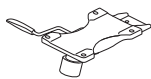
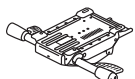

MESH BACK COLOR CODES (no upcharge): Black - **IM** Fog - **IF** Charcoal - **IC** Chai - **IH** Navy - **IY**

MECHANISM





| MECHANISM | CODE | FUNCTIONS | PRICE |
|--|-----------|--|---------------|
|  | S1 | Limited Synchro-Tilt A, E, J, K, L, W | +\$0 |
|  | Y2 | Advanced Synchro-Tilt A, D, E, J, L, W, A-D | +\$65 |
|  | Y3 | Advanced Synchro-Tilt with Independent Back Angle A, D, E, J, L, W, A-E | +\$105 |
|  | Y4 | Synchro-Tilt A, D, E, J, L, W, A-D (Big and Tall models only) | +\$0 |
|  | W5 | Weight-Activated A, D, E, L, W, A-D | +\$150 |

(See pages 18-19 for Seating Functions.)



BASE

| BASE | CODE | DESCRIPTION | PRICE |
|---|-----------|-------------------|---------------|
|  | SB | Standard Base | +\$0 |
|  | PA | Polished Aluminum | +\$110 |

CASTERS

| CASTERS | CODE | DESCRIPTION | PRICE |
|---|----------|--|--------------|
|  | A | All-Surface Caster (High-back and Big and Tall models only) | +\$0 |
|  | H | Hard Caster | +\$0 |
|  | S | Soft Caster | +\$30 |
|  | R | Roll Control Caster | +\$50 |

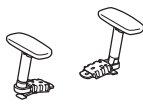
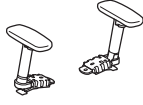
ARM STYLE

| ARM STYLE | CODE | DESCRIPTION | PRICE |
|--|----------|--------------------------------------|---------------|
| | N | Armless | +\$0 |
|  | F | Fixed - Black | +\$65 |
|  | A | Height and Width Adjustable Arms | +\$75 |
|  | V | All-Adjustable Arms - includes pivot | +\$115 |
|  | P | Fixed - Polished Alum. | +\$150 |

TASK DIMENSIONS

| MODEL | HLEU | HLWU | HLWM | HLTU | HLTM | HLTP |
|-------------------------|-------------------|-------------|-------------|-------------|-------------|-------------|
| Overall Width Armless | 28½ | 28½ | 28½ | 28½ | 28½ | 28½ |
| Overall Width with Arms | A/V 28½ | 28½ | 28½ | 28½ | 28½ | 28½ |
| Overall Depth | 28½ | 28½ | 28½ | 28½ | 28½ | 28½ |
| Overall Height | S1 47¾ | 44½ | 44½ | 41¼ | 40¼ | 41¼ |
| | Y2/Y3 49½ | 46 | 46 | 42½ | 42½ | 42½ |
| | W5 49 | 48¾ | 48¾ | 43 | 43 | 43 |
| Seat Width | 20 | 20 | 20 | 19 | 19 | 19 |
| Seat Depth | S1 15¾ | 15¾ | 15¾ | 18⅞ | 18⅞ | 18⅞ |
| | Y2/Y3 15¼-18¼ | 15¼-18¼ | 15¼-18¼ | 15¼-18¼ | 15¼-18¼ | 15¼-18¼ |
| | W5 15½-17¾ | 15½-17¾ | 15½-17¾ | 15½-17¾ | 15½-17¾ | 15½-17¾ |
| Usable Seat Depth | S1 15¾ | 15¾ | 15¾ | 15⅞ | 15⅞ | 15⅞ |
| | Y2/Y3 15¼-18¼ | 15¼-18¼ | 15¼-18¼ | 15¼-18¼ | 15¼-18¼ | 15¼-18¼ |
| | W5 15½-17¾ | 15½-17¾ | 15½-17¾ | 15½-17¾ | 15½-17¾ | 15½-17¾ |
| Seat Height (mechanism) | S1 16⅝-22 | 16⅝-22 | 16⅝-22 | 16⅝-22 | 16⅝-22 | 16⅝-22 |
| | Y2/Y3 17½-22 | 17½-22 | 17½-22 | 17½-22 | 17½-22 | 17½-22 |
| | W5 17¼-21¾ | 17¼-21¾ | 17¼-21¾ | 17¼-21¾ | 17¼-21¾ | 17¼-21¾ |
| Back Width | 21⅞ | 21¼ | 19¼ | 19¼ | 18 | 19¾ |
| Back Height | 29¾ | 25 | 25 | 22¾ | 21¾ | 22¾ |
| Ship Weight Armless | S1 40 S | 51 S | 48 S | 51 S | 32 S | 40 S |
| | Y2 57 S | 48 S | 45 S | 54 S | 46 S | 56 S |
| | Y3 60 S | 52 S | 48 S | 58 S | 50 S | 59 S |
| | W5 56 S | 47 S | 44 S | 54 S | 45 S | 55 S |
| Weight with Arms | S1 - | - | - | - | - | - |
| | Y2 65 S | 56 S | 53 S | 62 S | 54 S | 64 S |
| | Y3 68 S | 60 S | 56 S | 66 S | 58 S | 67 S |
| | W5 64 S | 55 S | 52 S | 62 S | 53 S | 63 S |
| Between Arms | A/V 17½-20 | 17½-20 | 17½-20 | 16¾-19¼ | 16¾-19¼ | 16¾-19¼ |
| | F/P 20½ | 20½ | 20½ | 20½ | 20½ | 20½ |
| COM | 2.0 | 2.0 | 1.0 | 2.0 | 1.0 | 2.0 |
| Weight Capacity | 300 lbs | 300 lbs | 300 lbs | 300 lbs | 300 lbs | 300 lbs |

BIG & TALL & STOOL DIMENSIONS

| MODEL | HLWUBT | HLWMBT | HLEUBT | HLTSU | HLTSM | HLTSP |
|-------------------------|---------------|---------|---------|-------------|-------------|-------------|
| Overall Width Armless | 28½ | 28½ | 28½ | 28½ | 28½ | 28½ |
| Overall Width with Arms | A/V 28½ | 28½ | 28½ | 28½ | 28½ | 28½ |
| Overall Depth | 28½ | 28½ | 28½ | 28½ | 28½ | 28½ |
| Overall Height | S1 - | - | - | 42½ | 42½ | 42½ |
| | Y4 49½ | 49½ | 49½ | - | - | - |
| Seat Width | 23 | 23 | 23 | 19 | 19 | 19 |
| Seat Depth | S1 - | - | - | 15¼-18¼ | 15¼-18¼ | 15¼-18¼ |
| | Y4 21 | 21 | 21 | 15¼-18¼ | 15¼-18¼ | 15¼-18¼ |
| Usable Seat Depth | S1 - | - | - | 15¼-18¼ | 15¼-18¼ | 15¼-18¼ |
| | Y4 17¾-19¼ | 17¼-18¾ | 17¾-19¼ | - | - | - |
| Seat Height (mechanism) | S1 - | - | - | 17½-22 | 17½-22 | 17½-22 |
| | Y4 17½-22 | 17½-22 | 17½-22 | - | - | - |
| Back Width | 23½ | 22½ | 23¼ | 19¾ | 19¾ | 19¾ |
| Back Height | 25 | 25¾ | 28¼ | 22¾ | 22¾ | 22¾ |
| Ship Weight Armless | S1 - | - | - | 54 S | 54 S | 54 S |
| | Y4 57 | 57 | 57 | - | - | - |
| Weight with Arms | S1 - | - | - | 62 S | 62 S | 62 S |
| | Y4 65 | 65 | 65 | - | - | - |
| Between Arms | A/V 20½-23 | 20½-23 | 20½-23 | 16¾-19¼ | 16¾-19¼ | 16¾-19¼ |
| | F/P 23½ | 23½ | 23½ | 20½ | 20½ | 20½ |
| COM | 2.0 | 1.5 | 2.0 | 2.0 | 2.0 | 2.0 |
| Weight Capacity | 450 lbs | 450 lbs | 450 lbs | 300 lbs | 300 lbs | 300 lbs |

ENDORSE® Fabric Options

HON BRANDED FABRICS *(For Seating)*

| GRADE 1 | GRADE 2 | GRADE 3 | GRADE L |
|--------------------------|-----------------|------------------|----------------|
| Attire | Appoint Seating | In Season | Denver Leather |
| Centurion | Clyde | Purl | |
| Compass | Dotty | Silvertex™ Vinyl | |
| Contourette Polyurethane | Rush | | |
| Dapper | Seed | | |
| Hamilton | Spin Seating | | |
| Inertia | Whisper Vinyl | | |
| Optic | | | |

For a complete list of fabrics, including partnership fabrics, go to hon.com/fabricsandfinishes.

Reference Fabric Color Combinations on pages 20-24 for color codes and legend on page 21 for lead times. For additional HON to Supply COM fabric grade pricing, go to honready.hon.com and click on the HON to Supply COM link.

*The following Endorse® models are not available in Beeline SMOMBEE: HLEU, HLWU, HLTU, HLTP, HLWUBT, HLEUBT, HLTSU, HLTSP.

🔥 For Fire Code model, availability and ordering method, refer to pages 28-31. Available on select models, contact HON Customer Support for availability.

ENDORSE® Finish Options

AVAILABLE FINISHES *(For Occasional Tables)*

Endorse® Occasional Tables are available in 16 laminate colors. Each laminate has a specific selection of edges available.

| L1 LAMINATE TOP COLORS | EDGE BAND COLORS |
|------------------------|---|
| Mahogany (N) | Mahogany (N), Loft (LOFT), Shadow (SHDW) |
| Shaker Cherry (F) | Shaker Cherry (F), Muslin (T), White (WHIT), Loft (LOFT), Shadow (SHDW) |
| Bourbon Cherry (H) | Bourbon Cherry (H), Muslin (T), White (WHIT) |
| Natural Maple (D) | Natural Maple (D), Muslin (T), White (WHIT), Loft (LOFT) |
| Brilliant White (WHIT) | Brilliant White (WHIT) |
| Charcoal (S) | Charcoal (S) |
| Silver Mesh (B9) | Loft (LOFT) |
| Cognac (COGN) | Cognac (COGN), Muslin (T), White (WHIT) |
| Mocha (MOCH) | Mocha (MOCH), Muslin (T), White (WHIT), Loft (LOFT), Shadow (SHDW) |
| Pinnacle (PINC) | Pinnacle (PINC), Muslin (T), White (WHIT), Loft (LOFT), Shadow (SHDW) |
| Harvest (C) | Harvest (C), Muslin (T), White (WHIT), Loft (LOFT) |

| L2 LAMINATE TOP COLORS | EDGE BAND COLORS |
|------------------------|---|
| Lowell Ash (LLA1) | Lowell Ash (DL), Muslin (T), White (WHIT), Loft (LOFT), Shadow (SHDW) |
| Natural Recon (LNR1) | Natural Recon (NR), Muslin (T), White (WHIT), Loft (LOFT), Shadow (SHDW) |
| Phantom Ecru (LPE1) | Phantom Ecru (PE), Muslin (T), White (WHIT), Loft (LOFT), Shadow (SHDW), Charcoal (S) |
| Portico Teak (LPT1) | Portico Teak (DP), Muslin (T), White (WHIT), Loft (LOFT), Shadow (SHDW), Charcoal (S) |
| Skyline Walnut (LSW1) | Skyline Walnut (SW), Muslin (T), White (WHIT), Loft (LOFT), Shadow (SHDW), Charcoal (S) |



Icon Legend on page 17

HLEU

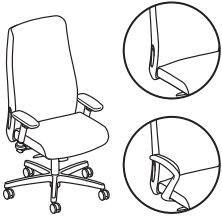

EXECUTIVE HIGH-BACK

Upholstered Back

- Pneumatic
- Swivel
- Synchro-tilt
- Tilt Tension
- Tilt Lock
- Integral Lumbar Support

Functions: **A, E, J, K, L, W**
 (Function Key on pages 18-19)

i Dimensions, weights and cubes shown above are for models using the S1 Endorse® control only. See page 77 for all other control specifications.

DIMENSIONS

| | | | |
|--------------|-----|-----------------------|----------|
| Depth: | 31½ | Arm Width: | 17½-20½ |
| Width: | 31½ | Seat to Floor Height: | 16⅝-22 |
| Height: | 47¾ | Usable Seat Depth: | 15¾ |
| Seat Depth: | 15¾ | Ship Weight: | 40 |
| Seat Width: | 19¾ | Cube: | 16.0 |
| Back Width: | 21⅝ | COM: | 2.0 |
| Back Height: | 29¾ | Weight Rating: | 300 lbs. |

FABRIC PRICE CODES

| | | | |
|----------|--------------|-----------|---------------|
| 1 | \$720 | 8 | \$996 |
| 2 | \$768 | 9 | \$1032 |
| 3 | \$816 | 10 | \$1068 |
| 4 | \$852 | 11 | \$1104 |
| 5 | \$888 | 12 | \$1140 |
| 6 | \$924 | L | — |
| 7 | \$960 | | |

HON Recommendation: HLEU.Y2.A.A.CU__SB - List Price \$860

HOW TO SPECIFY

| Select Model Number | Select Control Type | Select Arm Type | Select Caster/Glide | Select Fabric | Select Base |
|---|--|----------------------|---------------------|--|-------------|
| S1 Limited Synchro-Tilt Y2 Synchro-Tilt (+ \$65) Y3 Synchro-Tilt with Independent Back Angle (+ \$105) W5 Weight-Activated (+ \$150) | N Armless F Fixed Arms - Black (+ \$65) A Height and Width Adjustable Arms (+ \$75) V All-Adjustable Arms (includes pivot) (+ \$115) P Fixed Arms - Polished (+ \$150) | A All-Surface Caster | See page 78 | SB Standard Base PA Polished Aluminum (+ \$110) | |
| HLEU | Y2 | A | A | CU10 | SB |



HLWU

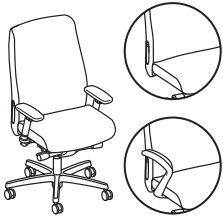

TASK MID-BACK

Upholstered Back

- Pneumatic
- Swivel
- Synchro-tilt
- Tilt Tension
- Tilt Lock
- Integral Lumbar Support

Functions: **A, E, J, K, L, W**
(Function Key on pages 18-19)

DIMENSIONS

| | | | |
|--------------|-----|------------------------|----------|
| Depth: | 28½ | Adjustable Arms Width: | 17½-20½ |
| Width: | 28½ | Fixed Arms Width: | 20½ |
| Height: | 44½ | Seat to Floor Height: | 16⅝-22 |
| Seat Depth: | 15¾ | Usable Seat Depth: | 15¾ |
| Seat Width: | 19¾ | Ship Weight: | 51 |
| Back Width: | 21¼ | Cube: | 11.1 |
| Back Height: | 25 | COM: | 2.0 |
| | | Weight Rating: | 300 lbs. |

FABRIC PRICE CODES

| | | | |
|----------|--------------|-----------|---------------|
| 1 | \$692 | 8 | \$968 |
| 2 | \$740 | 9 | \$1004 |
| 3 | \$788 | 10 | \$1040 |
| 4 | \$824 | 11 | \$1076 |
| 5 | \$860 | 12 | \$1112 |
| 6 | \$896 | L | — |
| 7 | \$932 | | |

❗ Do not need to specify back option for Upholstered Back models. Dimensions, weights and cubes shown above are for models using the S1 Endorse® control only. See page 77 for all other control specifications.

HLWM



TASK MID-BACK

ilira®-stretch Back

- Pneumatic
- Swivel
- Synchro-tilt
- Tilt Tension
- Tilt Lock
- Integral Lumbar Support

Functions: **A, E, J, K, L, W**
(Function Key on pages 18-19)

DIMENSIONS

| | | | |
|--------------|-----|------------------------|----------|
| Depth: | 28½ | Adjustable Arms Width: | 17½-20½ |
| Width: | 28½ | Fixed Arms Width: | 20½ |
| Height: | 44½ | Seat to Floor Height: | 16⅝-22 |
| Seat Depth: | 15¾ | Usable Seat Depth: | 15¾ |
| Seat Width: | 19¾ | Ship Weight: | 48 |
| Back Width: | 19 | Cube: | 11.1 |
| Back Height: | 25 | COM: | 1.0 |
| | | Weight Rating: | 300 lbs. |

FABRIC PRICE CODES

| | | | |
|----------|--------------|-----------|--------------|
| 1 | \$692 | 8 | \$830 |
| 2 | \$716 | 9 | \$848 |
| 3 | \$740 | 10 | \$866 |
| 4 | \$758 | 11 | \$884 |
| 5 | \$776 | 12 | \$902 |
| 6 | \$794 | L | \$892 |
| 7 | \$812 | | |

NOTES: For Mesh Back models, specify the ilira®-stretch back option below. Headrest available on Mid-back ilira®-stretch models only - Black only.

❗ Dimensions, weights and cubes shown above are for models using the S1 Endorse® control only. See page 77 for all other control specifications.

HON Recommendation: HLWM.Y2.A.H.IM.CU__SB.N - List Price \$832

HOW TO SPECIFY

| Select Model Number | Select Control Type | Select Arm Type | Select Caster/Glide | Select Mesh Back | Select Fabric | Select Base | Select Head Rest |
|---|---|--|---|------------------|--|---|------------------|
| S1 Limited Synchro-Tilt Y2 Synchro-Tilt (+ \$65) Y3 Synchro-Tilt with Independent Back Angle (+ \$105) W5 Weight-Activated (+ \$150) | N Armless F Fixed Arms - Black (+ \$65) A Height and Width Adjustable Arms (+ \$75) V All-Adjustable Arms (includes pivot) (+ \$115) P Fixed Arms - Polished (+ \$150) | H Hard Caster S Soft Caster (+ \$30) R Roll Control Caster (+ \$50) | ilira®-stretch options IM Black IF Fog IC Charcoal IH Chai IY Navy <i>Specify the back for Mesh Back models only</i> | See page 78 | SB Standard Base PA Polished Aluminum (+ \$110) | N No Headrest HR Headrest (+ \$80) <i>Black only. Specify for model HLWM only</i> | |
| HLWM | Y2 | A | H | IM | CU10 | SB | N |



Icon Legend on page 17

HLTU

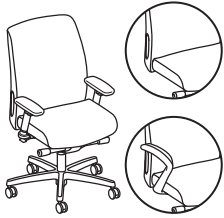

TASK LOW-BACK

Upholstered Back

- Pneumatic
- Swivel
- Synchro-tilt
- Tilt Tension
- Tilt Lock
- Integral Lumbar Support

Functions: **A, E, J, K, L, W**
(Function Key on pages 18-19)

DIMENSIONS

| | | | |
|--------------|-----|------------------------|----------|
| Depth: | 28½ | Adjustable Arms Width: | 16¾-19¼ |
| Width: | 28½ | Fixed Arms Width: | 19½ |
| Height: | 41¼ | Seat to Floor Height: | 16⅝-22 |
| Seat Depth: | 15⅝ | Usable Seat Depth: | 15⅝ |
| Seat Width: | 18⅞ | Ship Weight: | 51 |
| Back Width: | 19¾ | Cube: | 11.1 |
| Back Height: | 22¾ | COM: | 2.0 |
| | | Weight Rating: | 300 lbs. |

FABRIC PRICE CODES

| | | | |
|----------|--------------|-----------|---------------|
| 1 | \$644 | 8 | \$920 |
| 2 | \$692 | 9 | \$956 |
| 3 | \$740 | 10 | \$992 |
| 4 | \$776 | 11 | \$1028 |
| 5 | \$812 | 12 | \$1064 |
| 6 | \$848 | L | — |
| 7 | \$884 | | |

❗ Do not need to specify back option for Upholstered Back models. Dimensions, weights and cubes shown above are for models using the S1 Endorse® control only. See page 77 for all other control specifications.

HLTM

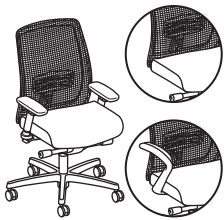

TASK LOW-BACK

ilira®-stretch Back

- Pneumatic
- Swivel
- Synchro-tilt
- Tilt Tension
- Tilt Lock
- Integral Lumbar Support

Functions: **A, E, J, K, L, W**
(Function Key on pages 18-19)

DIMENSIONS

| | | | |
|--------------|-----|------------------------|----------|
| Depth: | 28½ | Adjustable Arms Width: | 16¾-19¼ |
| Width: | 28½ | Fixed Arms Width: | 19½ |
| Height: | 40¾ | Seat to Floor Height: | 16⅝-22 |
| Seat Depth: | 15⅝ | Usable Seat Depth: | 15⅝ |
| Seat Width: | 18⅞ | Ship Weight: | 32 |
| Back Width: | 17¾ | Cube: | 11.1 |
| Back Height: | 21¾ | COM: | 1.0 |
| | | Weight Rating: | 300 lbs. |

FABRIC PRICE CODES

| | | | |
|----------|--------------|-----------|--------------|
| 1 | \$644 | 8 | \$782 |
| 2 | \$668 | 9 | \$800 |
| 3 | \$692 | 10 | \$818 |
| 4 | \$710 | 11 | \$836 |
| 5 | \$728 | 12 | \$854 |
| 6 | \$746 | L | \$844 |
| 7 | \$764 | | |

NOTES: For Mesh Back models, specify the ilira®-stretch back option below.

❗ Dimensions, weights and cubes shown above are for models using the S1 Endorse® control only. See page 77 for all other control specifications.

HLTP

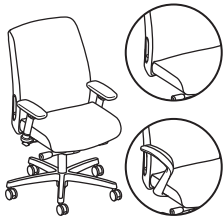

TASK LOW-BACK

Plastic Outer Back

- Pneumatic
- Swivel
- Synchro-tilt
- Tilt Tension
- Tilt Lock
- Integral Lumbar Support

Functions: **A, E, J, K, L, W**
(Function Key on pages 18-19)

DIMENSIONS

| | | | |
|--------------|-----|------------------------|----------|
| Depth: | 28½ | Adjustable Arms Width: | 16¾-19¼ |
| Width: | 28½ | Fixed Arms Width: | 19½ |
| Height: | 41¼ | Seat to Floor Height: | 16⅝-22 |
| Seat Depth: | 15⅝ | Usable Seat Depth: | 15⅝ |
| Seat Width: | 18⅞ | Ship Weight: | 40 |
| Back Width: | 19¾ | Cube: | 11.1 |
| Back Height: | 22¾ | COM: | 2.0 |
| | | Weight Rating: | 300 lbs. |

FABRIC PRICE CODES

| | | | |
|----------|--------------|-----------|---------------|
| 1 | \$697 | 8 | \$973 |
| 2 | \$745 | 9 | \$1009 |
| 3 | \$793 | 10 | \$1045 |
| 4 | \$829 | 11 | \$1081 |
| 5 | \$865 | 12 | \$1117 |
| 6 | \$901 | L | — |
| 7 | \$937 | | |

❗ Do not need to specify back option for Plastic Outer Back models. Dimensions, weights and cubes shown above are for models using the S1 Endorse® control only. See page 77 for all other control specifications.

HON Recommendation: HLTM.Y2.A.H.IM.CU__SB - List Price \$784

HOW TO SPECIFY

| Select Model Number | Select Control Type | Select Arm Type | Select Caster/Glide | Select Mesh Back | Select Fabric | Select Base |
|---------------------|---|---|--|--|---------------|--|
| HLTM | S1 Limited Synchro-Tilt Y2 Synchro-Tilt (+ \$65) Y3 Synchro-Tilt with Independent Back Angle (+ \$105) W5 Weight-Activated (+ \$150) | N Armless F Fixed Arms - Black (+ \$65) A Height and Width Adjustable Arms (+ \$75) V All-Adjustable Arms (includes pivot) (+ \$115) P Fixed Arms - Polished (+ \$150) | H Hard Caster S Soft Caster (+ \$30) R Roll Control Caster (+ \$50) | ilira®-stretch options IM Black IF Fog IC Charcoal IH Chai IY Navy Specify the back for Mesh Back models only | See page 78 | SB Standard Base PA Polished Aluminum (+ \$110) |
| HLTM | Y2 | A | H | IM | CU10 | SB |



HLWUBT

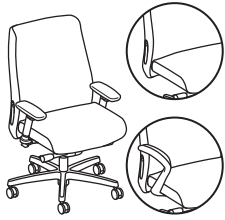

TASK MID-BACK

Big and Tall Upholstered Back

- Pneumatic
- Seat-glide
- Swivel
- Synchro-tilt
- Tilt Lock
- Side Tilt Tension
- Integral Lumbar Support

Functions: **A, D, E, A-D, J, L, W**
(Function Key on pages 18-19)

❗ Do not need to specify back option for Upholstered Back models.

DIMENSIONS

| | | | |
|--------------|-----|------------------------|----------|
| Depth: | 31½ | Adjustable Arms Width: | 21½-23¾ |
| Width: | 31½ | Fixed Arms Width: | 24 |
| Height: | 44⅝ | Seat to Floor Height: | 18-22¼ |
| Seat Depth: | 21 | Usable Seat Depth: | 17¾-19¼ |
| Seat Width: | 23 | Ship Weight: | 65 |
| Back Width: | 23½ | Cube: | 15.3 |
| Back Height: | 25 | COM: | 2.0 |
| | | Weight Rating: | 450 lbs. |

FABRIC PRICE CODES

| | | | |
|----------|---------------|-----------|---------------|
| 1 | \$1151 | 8 | \$1427 |
| 2 | \$1199 | 9 | \$1463 |
| 3 | \$1247 | 10 | \$1499 |
| 4 | \$1283 | 11 | \$1535 |
| 5 | \$1319 | 12 | \$1571 |
| 6 | \$1355 | L | — |
| 7 | \$1391 | | |

HLWMBT



TASK MID-BACK

Big and Tall ilira®-stretch Back

- Pneumatic
- Seat-glide
- Swivel
- Synchro-tilt
- Tilt Lock
- Side Tilt Tension
- Integral Lumbar Support

Functions: **A, D, E, A-D, J, L, W**
(Function Key on pages 18-19)

NOTES: For Mesh Back models, specify the ilira®-stretch back option below. Headrest available on Mid-back ilira®-stretch models only - Black only.

DIMENSIONS

| | | | |
|--------------|-----|------------------------|----------|
| Depth: | 31½ | Adjustable Arms Width: | 21½-23¾ |
| Width: | 31½ | Fixed Arms Width: | 24 |
| Height: | 44⅝ | Seat to Floor Height: | 18-22¼ |
| Seat Depth: | 21 | Usable Seat Depth: | 17¼-18¾ |
| Seat Width: | 23 | Ship Weight: | 75 |
| Back Width: | 22½ | Cube: | 15.3 |
| Back Height: | 25¾ | COM: | 1.5 |
| | | Weight Rating: | 450 lbs. |

FABRIC PRICE CODES

| | | | |
|----------|---------------|-----------|---------------|
| 1 | \$1151 | 8 | \$1358 |
| 2 | \$1187 | 9 | \$1385 |
| 3 | \$1223 | 10 | \$1412 |
| 4 | \$1250 | 11 | \$1439 |
| 5 | \$1277 | 12 | \$1466 |
| 6 | \$1304 | L | \$1451 |
| 7 | \$1331 | | |

HLEUBT

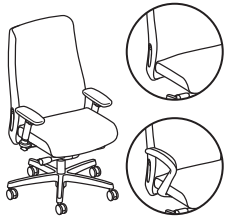

EXECUTIVE HIGH-BACK

Big and Tall Upholstered Back

- Pneumatic
- Seat-glide
- Swivel
- Synchro-tilt
- Tilt Lock
- Side Tilt Tension
- Integral Lumbar Support

Functions: **A, D, E, A-D, J, L, W**
(Function Key on pages 18-19)

❗ Executive High-back Big and Tall models are available with an upholstered back only.

DIMENSIONS

| | | | |
|--------------|-----|------------------------|----------|
| Depth: | 31½ | Adjustable Arms Width: | 21½-23¾ |
| Width: | 31½ | Fixed Arms Width: | 24 |
| Height: | 46⅝ | Seat to Floor Height: | 18-22¼ |
| Seat Depth: | 21 | Usable Seat Depth: | 17¾-19¼ |
| Seat Width: | 23 | Ship Weight: | 74 |
| Back Width: | 23¾ | Cube: | 16.0 |
| Back Height: | 28¾ | COM: | 2.0 |
| | | Weight Rating: | 450 lbs. |

FABRIC PRICE CODES

| | | | |
|----------|---------------|-----------|---------------|
| 1 | \$1178 | 8 | \$1454 |
| 2 | \$1226 | 9 | \$1490 |
| 3 | \$1274 | 10 | \$1526 |
| 4 | \$1310 | 11 | \$1562 |
| 5 | \$1346 | 12 | \$1598 |
| 6 | \$1382 | L | — |
| 7 | \$1418 | | |

HON Recommendation: HLWMBT.Y4.A.A.IM.CU__SB.N - List Price \$1226

HOW TO SPECIFY

| Select Model Number | Select Control Type | Select Arm Type | Select Caster/Glide | Select Mesh Back | Select Fabric | Select Base | Select Head Rest |
|---------------------|---|---|--|---|---------------|-------------------------|---|
| HLWMBT | Y4 <i>Y4 is the only control option for the Big and Tall models</i> | N Armless F Fixed Arms - Black (+ \$65) A Height and Width Adjustable Arms (+ \$75) V All-Adjustable Arms (includes pivot) (+ \$115) P Fixed Arms - Polished (+ \$150) | A All-surface Caster <i>All-surface caster available on Big and Tall models only</i> | ilira®-stretch option <i>Black only</i> IM Black <i>Specify the back for Mesh Back models only</i> | See page 78 | SB Standard Base | N No Head Rest HR Head Rest (+ \$80) <i>Black only. Specify for model HLWMBT only</i> |
| HLWMBT | Y4 | A | A | IM | CU10 | SB | N |



Icon Legend on page 17

HLTSU



STOOL

Upholstered Back

- Pneumatic
- Swivel
- Synchro-tilt
- Tilt Tension
- Tilt Lock
- Integral Lumbar Support

Functions: **A, E, J, K, L, W**
(Function Key on pages 18-19)

❗ Do not need to specify back option for Upholstered Back models.

DIMENSIONS

| | | | |
|--------------|-----|------------------------|----------|
| Depth: | 28½ | Adjustable Arms Width: | 16¾-19¼ |
| Width: | 28½ | Fixed Arms Width: | 19½ |
| Height: | 53½ | Seat to Floor Height: | 23¼-33¼ |
| Seat Depth: | 15½ | Usable Seat Depth: | 15½ |
| Seat Width: | 18½ | Ship Weight: | 60 |
| Back Width: | 19¾ | Cube: | 11.1 |
| Back Height: | 22¾ | COM: | 2.0 |
| | | Weight Rating: | 300 lbs. |

FABRIC PRICE CODES

| | | | |
|----------|---------------|-----------|---------------|
| 1 | \$768 | 8 | \$1044 |
| 2 | \$816 | 9 | \$1080 |
| 3 | \$864 | 10 | \$1116 |
| 4 | \$900 | 11 | \$1152 |
| 5 | \$936 | 12 | \$1188 |
| 6 | \$972 | L | — |
| 7 | \$1008 | | |

HLTSM



STOOL

ilira®-stretch Back

- Pneumatic
- Swivel
- Synchro-tilt
- Tilt Tension
- Tilt Lock
- Integral Lumbar Support

Functions: **A, E, J, K, L, W**
(Function Key on pages 18-19)

NOTES: For Mesh Back models, specify the ilira®-stretch back option below.

DIMENSIONS

| | | | |
|--------------|-----|------------------------|----------|
| Depth: | 28½ | Adjustable Arms Width: | 16¾-19¼ |
| Width: | 28½ | Fixed Arms Width: | 19½ |
| Height: | 52½ | Seat to Floor Height: | 23¼-33¼ |
| Seat Depth: | 15½ | Usable Seat Depth: | 15½ |
| Seat Width: | 18½ | Ship Weight: | 54 |
| Back Width: | 17¾ | Cube: | 11.1 |
| Back Height: | 21¾ | COM: | 1.0 |
| | | Weight Rating: | 300 lbs. |

FABRIC PRICE CODES

| | | | |
|----------|--------------|-----------|--------------|
| 1 | \$768 | 8 | \$906 |
| 2 | \$792 | 9 | \$924 |
| 3 | \$816 | 10 | \$942 |
| 4 | \$834 | 11 | \$960 |
| 5 | \$852 | 12 | \$978 |
| 6 | \$870 | L | \$968 |
| 7 | \$888 | | |

HLTSP



STOOL

Plastic Outer Back

- Pneumatic
- Swivel
- Synchro-tilt
- Tilt Tension
- Tilt Lock
- Integral Lumbar Support

Functions: **A, E, J, K, L, W**
(Function Key on pages 18-19)

❗ Do not need to specify back option for Outer Back models.

DIMENSIONS

| | | | |
|--------------|-----|------------------------|----------|
| Depth: | 28½ | Adjustable Arms Width: | 16¾-19¼ |
| Width: | 28½ | Fixed Arms Width: | 19½ |
| Height: | 52½ | Seat to Floor Height: | 23¼-33¼ |
| Seat Depth: | 15½ | Usable Seat Depth: | 15½ |
| Seat Width: | 18½ | Ship Weight: | 65 |
| Back Width: | 19¾ | Cube: | 11.1 |
| Back Height: | 22¾ | COM: | 2.0 |
| | | Weight Rating: | 300 lbs. |

FABRIC PRICE CODES

| | | | |
|----------|---------------|-----------|---------------|
| 1 | \$822 | 8 | \$1098 |
| 2 | \$870 | 9 | \$1134 |
| 3 | \$918 | 10 | \$1170 |
| 4 | \$954 | 11 | \$1206 |
| 5 | \$990 | 12 | \$1242 |
| 6 | \$1026 | L | — |
| 7 | \$1062 | | |

HON Recommendation: HLTSM.S1.A.H.IM.CU__SB - List Price \$843

HOW TO SPECIFY

| Select Model Number | Select Control Type | Select Arm Type | Select Caster/Glide | Select Mesh Back | Select Fabric | Select Base |
|---------------------|---|---|--|---|---------------|--|
| | S1 Limited Synchro-Tilt <i>S1 is the only control option for the Stool models</i> | N Armless F Fixed Arms - Black (+ \$65) A Height and Width Adjustable Arms (+ \$75) V All-Adjustable Arms (includes pivot) (+ \$115) P Fixed Arms - Polished (+ \$150) | H Hard Caster S Soft Caster (+ \$30) R Roll Control Caster (+ \$50) | ilira®-stretch options IM Black IF Fog IC Charcoal IH Chai IY Navy <i>Specify the back for Mesh Back models only</i> | See page 78 | SB Standard Base PA Polished Aluminum (+ \$110) |
| HLTSM | S1 | A | H | IM | CU10 | SB |



HL2DARM



ADJUSTABLE T-ARMS

Height and Width
 Functions: **S**
 (Function Key on pages 18-19)

DIMENSIONS

Adjustable Arms Width: 16¾-19¼
 Height from Seat: 7¼-11
 Ship Weight: 8 **S**
 Cube: 1.0

LIST PRICE

\$117

! Available in Black only. No need to specify.

HL4DARM



ALL-ADJUSTABLE ARMS

Height, Width, Depth and Pivot

DIMENSIONS

Adjustable Arms Width: 16¾-19¼
 Height from Seat: 7¼-11
 Ship Weight: 8 **S**
 Cube: 1.0

LIST PRICE

\$158

! Available in Black only. No need to specify.

HIFHA



FIXED HEIGHT ARMS

DIMENSIONS

Arm Width: 20
 Height from Seat: 9½
 Ship Weight: 7 **S**
 Cube: 1.0

LIST PRICE

\$107

HIPAA

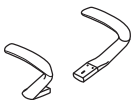

POLISHED ALUMINUM ARMS

Fixed Height

DIMENSIONS

Arm Width: 20
 Height from Seat: 9½
 Ship Weight: 10 **S**
 Cube: 1.0

LIST PRICE

\$180

HLMSHHR



MESH HEADREST

DIMENSIONS

Mesh Width: 12
 Mesh Height: 6
 Ship Weight: 3 **S**
 Cube: 1.0

QA DIMENSIONS

(Attachment Mechanism)

Width: 12
 Depth: 6
 Height: 12

LIST PRICE

\$122

! Available in Black Mesh (IM) only. For use with Mesh Mid-back models only.



Icon Legend on page 17

ENDORSE® Lounge

HL1SL



LOUNGE

Single Seat

DIMENSIONS

| | | | |
|--------------|-----|-----------------------|----------|
| Depth: | 33½ | Arm Width: | 24 |
| Width: | 30½ | Seat to Floor Height: | 18¼ |
| Height: | 26¼ | Usable Seat Depth: | 20½ |
| Seat Depth: | 22 | Ship Weight: | 75 |
| Seat Width: | 23½ | Cube: | 19.0 |
| Back Width: | 23½ | COM: | 4.5 |
| Back Height: | 19½ | Weight Rating: | 300 lbs. |

FABRIC PRICE CODES

| | | | |
|---|--------|----|--------|
| 1 | \$1567 | 8 | \$2188 |
| 2 | \$1675 | 9 | \$2269 |
| 3 | \$1783 | 10 | \$2350 |
| 4 | \$1864 | 11 | \$2431 |
| 5 | \$1945 | 12 | \$2512 |
| 6 | \$2026 | L | \$2467 |
| 7 | \$2107 | | |

HL2SL

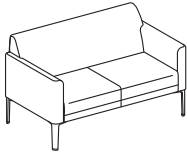

LOUNGE

Two-Seat

DIMENSIONS

| | | | |
|--------------|-----|-----------------------|----------|
| Depth: | 33½ | Arm Width: | 48 |
| Width: | 54½ | Seat to Floor Height: | 18¼ |
| Height: | 26¼ | Usable Seat Depth: | 20½ |
| Seat Depth: | 22 | Ship Weight: | 100 |
| Seat Width: | 47½ | Cube: | 33.4 |
| Back Width: | 47½ | COM: | 6.0 |
| Back Height: | 19½ | Weight Rating: | 300 lbs. |

FABRIC PRICE CODES

| | | | |
|---|--------|----|--------|
| 1 | \$2115 | 8 | \$2943 |
| 2 | \$2259 | 9 | \$3051 |
| 3 | \$2403 | 10 | \$3159 |
| 4 | \$2511 | 11 | \$3267 |
| 5 | \$2619 | 12 | \$3375 |
| 6 | \$2727 | L | \$3315 |
| 7 | \$2835 | | |

HL3SL

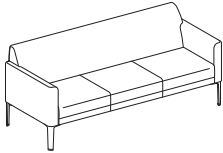

LOUNGE

Three-Seat

DIMENSIONS

| | | | |
|--------------|-----|-----------------------|----------|
| Depth: | 33½ | Arm Width: | 72 |
| Width: | 78½ | Seat to Floor Height: | 18¼ |
| Height: | 26¼ | Usable Seat Depth: | 20½ |
| Seat Depth: | 22 | Ship Weight: | 115 |
| Seat Width: | 71½ | Cube: | 45.7 |
| Back Width: | 71½ | COM: | 7.5 |
| Back Height: | 19½ | Weight Rating: | 300 lbs. |

FABRIC PRICE CODES

| | | | |
|---|--------|----|--------|
| 1 | \$2819 | 8 | \$3854 |
| 2 | \$2999 | 9 | \$3989 |
| 3 | \$3179 | 10 | \$4124 |
| 4 | \$3314 | 11 | \$4259 |
| 5 | \$3449 | 12 | \$4394 |
| 6 | \$3584 | L | \$4319 |
| 7 | \$3719 | | |

HON Recommendation: HL1SL.RL.PNS__P6N - List Price \$1675

HOW TO SPECIFY

| | | | |
|--|---|--|--|
| <p>Select Model Number</p> <p>HL1SL</p> | <p>Select Leg Type</p> <p>RL Rounded Leg</p> <p>RL</p> | <p>Select Fabric</p> <p>See page 78</p> <p>PNS007</p> | <p>Select Frame</p> <p>BLCK Textured Black P6N Textured Satin Chrome</p> <p>P6N</p> |
|--|---|--|--|



HLOCC1



Model shown without
grommet option



SQUARE

Open All Sides

DIMENSIONS

| | | | |
|---------|----|--------------|-----|
| Depth: | 24 | Ship Weight: | 45 |
| Width: | 24 | Cube: | 2.6 |
| Height: | 19 | | |

LIST PRICE

| | |
|------------|-------|
| Laminate 1 | \$830 |
| Laminate 2 | \$845 |

NOTES: Ships in two boxes. For additional grommet options, see page 122.

HLOCC2



Model shown with
Round grommet option



SQUARE

Open Front and Back

DIMENSIONS

| | | | |
|---------|----|--------------|-----|
| Depth: | 24 | Ship Weight: | 55 |
| Width: | 24 | Cube: | 2.6 |
| Height: | 19 | | |

LIST PRICE

| | |
|------------|-------|
| Laminate 1 | \$896 |
| Laminate 2 | \$911 |

NOTES: Enclosed on sides. Ships in three boxes. For additional grommet options, see page 122.

HLOCC3

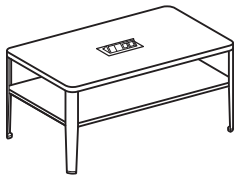

Model shown with Flip-top
Port grommet option



RECTANGULAR

Open All Sides

DIMENSIONS

| | | | |
|---------|----|--------------|-----|
| Depth: | 24 | Ship Weight: | 65 |
| Width: | 40 | Cube: | 3.1 |
| Height: | 19 | | |

LIST PRICE

| | |
|------------|-------|
| Laminate 1 | \$962 |
| Laminate 2 | \$982 |

NOTES: Ships in two boxes. For additional grommet options, see page 122.

HTPWRGROM1

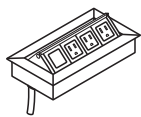

POP-UP PORT

- Fits into 4" x 8" cutout.
- Specify G1 cutout in table top.
- Pop-up Port provides three power ports and one blank data receptacle.
- Sits flush with worksurface when closed.
- Finish is anodized aluminum.
- Includes 6' cord with three-prong plug.

DIMENSIONS

| | |
|--------------|-----|
| Ship Weight: | 5 |
| Cube: | 0.3 |

LIST PRICE

\$360

HON Recommendation: HLOCC3.N.PINCPINC.P6N - List Price \$962

HOW TO SPECIFY

| | | | |
|--|---|--|---|
| <p>Select Model Number</p> <p>H L O C C 3 .</p> | <p>Select Grommet Option</p> <p>N No Grommet G Round Grommet (+ \$15) G1 Pop-up Port Grommet Cut-out only (+ \$40)</p> <p>N .</p> | <p>Select Laminate and Edge</p> <p>See page 78</p> <p>P I N C P I N C .</p> | <p>Select Frame</p> <p>BLCK Textured Black P6N Textured Satin Chrome</p> <p>P 6 N</p> |
|--|---|--|---|



ENTIRE™ Mesh Chairs

HVL541



HIGH-BACK

- Pneumatic
- Swivel
- Tilt
- Tilt Tension
- Tilt Lock
- Adjustable Lumbar
- Height-adjustable Arms

Functions: **A, E, F, K, L, Q, W**
(Function Key on pages 18-19)

DIMENSIONS

| | | | |
|--------------|--------------------------------|-----------------------|--|
| Depth: | 28 ³ / ₈ | Arm Width: | 19 ³ / ₄ |
| Width: | 28 ³ / ₈ | Seat to Floor Height: | 17 ³ / ₄ -22 ¹ / ₂ |
| Height: | 43 ³ / ₈ | Usable Seat Depth: | 19 ¹ / ₄ |
| Seat Depth: | 19 ¹ / ₄ | Ship Weight: | 44 Ⓢ |
| Seat Width: | 19 ⁵ / ₈ | Cube: | 4.0 |
| Back Width: | 16 ³ / ₄ | Weight Rating: | 250 lbs. |
| Back Height: | 22 ⁵ / ₄ | | |

PRICE CODE

Fabric **\$319**

NOTES: Comfortable and breathable mesh back. Black fabric seat. Black frame. Height-adjustable arms. **HON 5-Year Limited Warranty.**
HON Recommendation: HVL541.LH10 - List Price \$319

HOW TO SPECIFY

| | |
|---|---|
| <p>Select Model Number</p> | <p>Select Fabric</p> <p>LH10 Black Fabric</p> |
| <div style="display: flex; gap: 5px;"> <div style="border: 1px solid black; padding: 2px 5px;">H</div> <div style="border: 1px solid black; padding: 2px 5px;">V</div> <div style="border: 1px solid black; padding: 2px 5px;">L</div> <div style="border: 1px solid black; padding: 2px 5px;">5</div> <div style="border: 1px solid black; padding: 2px 5px;">4</div> <div style="border: 1px solid black; padding: 2px 5px;">1</div> </div> | <div style="display: flex; gap: 5px;"> <div style="border: 1px solid black; padding: 2px 5px;">L</div> <div style="border: 1px solid black; padding: 2px 5px;">H</div> <div style="border: 1px solid black; padding: 2px 5px;">1</div> <div style="border: 1px solid black; padding: 2px 5px;">0</div> </div> |

EXPOSURE™ Mesh Chairs

OPEN MARKET



Icon Legend on page 17

HVL721



HIGH-BACK

Pneumatic
Swivel
Synchronized Tilt
Tilt Tension
Tilt Lock
Seat Glide Mechanism
Adjustable Lumbar
Height and Width Adjustable
Arms

Functions: **A, D, E, J, K, L, S, W**
(Function Key on pages 18-19)

NOTES: Available in Black SofThread™ Leather with Chrome accents. Available in Black fabric with Black accents. Comfortable and breathable mesh back. Adjustable seat glide mechanism. Height and width adjustable arms. Adjustable lumbar support. **HON 5-Year Limited Warranty.**

! LH10 Fabric only available with Black Frame/Base. SB11 Fabric only available with Chrome Frame/Base.

HON Recommendation: HVL721.SB11 - List Price \$502

DIMENSIONS

| | | | |
|--------------|---------|-----------------------|----------|
| Depth: | 26¾ | Arm Width: | 16½-18¾ |
| Width: | 26½ | Seat to Floor Height: | 17½-22 |
| Height: | 42½ | Usable Seat Depth: | 17½-19½ |
| Seat Depth: | 17½-19½ | Ship Weight: | 40 Ⓢ |
| Seat Width: | 19½ | Cube: | 5.5 |
| Back Width: | 18½ | Weight Rating: | 250 lbs. |
| Back Height: | 24¼ | | |

PRICE CODE

| | |
|----------------|--------------|
| Fabric | \$455 |
| Leather | \$502 |

HOW TO SPECIFY

Select
Model Number

Select
Fabric

SB11 Black SofThread™ Leather
LH10 Black Fabric

H V L 7 2 1 .

S B 1 1

FLOCK®



Flock Seating and Tables.

FLOCK®

Break away. Come together. Wherever people migrate within a space, Flock is designed to support their needs. With a full collection of mobile, flexible and comfortable seating elements and coordinating collaborative tables that work seamlessly together, you can make the most of every square inch of your space. Modular lounge chairs and ottomans stand alone or combine to create large arrangements. Multi-purpose stools and chairs add comfort to open spaces. Collaborative tables that bring the whole group together. Flock helps people interact with each other, challenge one another, and receive the support they need.



CHAIR FEATURES

- Round and square lounge chairs are fully-upholstered.
- The contemporary aesthetic easily matches a variety of surroundings.
- Support everything from one-on-one conversations to large meetings.
- Choose from four leg options — standard, tapered round, tapered square or hard casters.
- Standard legs can be adjusted ½" for leveling.
- Available in hundreds of quality HON fabrics.
- Warranted for users up to 300 lbs.

COLLABORATIVE TABLES

- Choose from round, square, rectangle or racetrack shaped table tops.
- Optional grommets neatly route cords.
- Bases available in disc, T-leg and X-leg styles.
- Choose bases with or without footrings.
- Each base includes leveling glides that adjust in 1" increments.
- Tops are available in eight laminate finishes.
- Bases are available in either Textured Satin Chrome or Textured Charcoal finish.

FLOCK® Options

MODEL OPTIONS

HFLSC1
HFLSC1DF - Dual Fabric

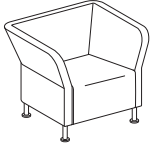

Lounge Chair
Square

HFLRC1
HFLRC1DF - Dual Fabric

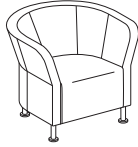

Lounge Chair
Round

HFLMC1
HFLMC1DF - Dual Fabric

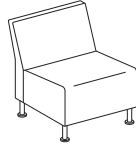

Modular Chair

HFLML1
HFLML1DF - Dual Fabric

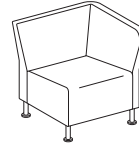

Modular
Left End

HFLMR1
HFLMR1DF - Dual Fabric

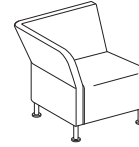

Modular
Right End

HFLCC1
HFLCC1DF - Dual Fabric

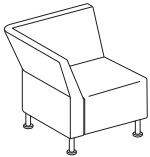

True Chair
Corner

HFLWI45
HFLWI45DF - Dual Fabric

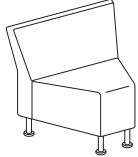

Wedge
Inside

HFLWO45
HFLWO45DF - Dual Fabric



Wedge
Outside

HFL450

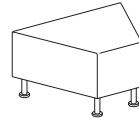

Wedge Ottoman

HFLSC1S
HFLSC1SDF - Dual Fabric

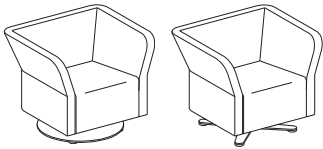

Square Lounge Chair
Swivel Base or X-Base

HFLRC1S
HFLRC1SDF - Dual Fabric

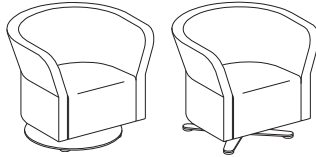

Round Lounge Chair
Swivel Base or X-Base

HFLMC1S
HFLMC1SDF - Dual Fabric

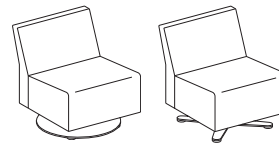

Modular Chair
Swivel Base or X-Base

LEG STYLE



| CODE | DESCRIPTION | PRICE |
|----------|--------------|-------------|
| L | Standard Leg | +\$0 |



| | | |
|-----------|----------------|-------------|
| TS | Tapered Square | +\$0 |
|-----------|----------------|-------------|



| | | |
|-----------|---------------|-------------|
| TR | Tapered Round | +\$0 |
|-----------|---------------|-------------|



| | | |
|----------|--------------|-------------|
| H | Hard Casters | +\$0 |
|----------|--------------|-------------|

LEG COLOR

| CODE | DESCRIPTION | PRICE |
|------------|-----------------------|-------------|
| P6N | Textured Satin Chrome | +\$0 |
| P7A | Textured Charcoal | +\$0 |

**Specify P6N and P7A for Standard, Tapered Round and Tapered Square legs only*

| | | |
|----------|-------------------|-------------|
| T | Black Hard Caster | +\$0 |
|----------|-------------------|-------------|

**Specify for Hard Caster option only*

HON BRANDED FABRICS

| GRADE 1 | GRADE 2 | GRADE 3 | GRADE L |
|--------------------------|-----------------|------------------|----------------|
| Attire | Appoint Seating | In Season | Denver Leather |
| Centurion | Clyde | Purl | |
| Compass | Dotty | Silvertex™ Vinyl | |
| Contourette Polyurethane | Rush | | |
| Dapper | Seed | | |
| Hamilton | Spin Seating | | |
| Inertia | Whisper Vinyl | | |
| Optic | | | |

For a complete list of fabrics, including partnership fabrics, go to hon.com/fabricsandfinishes.

Flock® chair model HFLRC1 has fabric limitations, please see the Flock® seating pages 92-101 for details.

Reference Fabric Color Combinations on pages 20-24 for color codes and legend on page 21 for lead times.

 For Fire Code model, availability and ordering method, refer to pages 28-31. Available on select models, contact HON Customer Support for availability.

FLOCK® ROUND LOUNGE HFLRC1/DF HON BRANDED FABRICS

| GRADE 1 | GRADE 2 | GRADE 3 | GRADE L |
|--------------------------|-----------------|------------------|----------------|
| Centurion | Appoint Seating | In Season | Denver Leather |
| Compass | Clyde | Purl | |
| Contourette Polyurethane | Rush | Silvertex™ Vinyl | |
| Dapper | Seed* | | |
| Hamilton | Spin Seating | | |
| Inertia | Whisper Vinyl | | |
| Optic | | | |

For a complete list of fabrics, including partnership fabrics, go to hon.com/fabricsandfinishes.

Reference Fabric Color Combinations on pages 20-24 for color codes and legend on page 21 for lead times.

*Available on seat only.

 For Fire Code model, availability and ordering method, refer to pages 28-31. Available on select models, contact HON Customer Support for availability.



HFLSC1

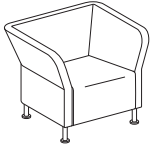

LOUNGE CHAIR

Square

DIMENSIONS

| | | | |
|--------------|-----|-----------------------|----------|
| Depth: | 28½ | Arm Width: | 27½ |
| Width: | 34¼ | Seat to Floor Height: | 17 |
| Height: | 28 | Usable Seat Depth: | 20½ |
| Seat Depth: | 20½ | Ship Weight: | 79 |
| Seat Width: | 21½ | Cube: | 21.9 |
| Back Width: | 21½ | COM: | 5.0 |
| Back Height: | 18½ | Weight Rating: | 300 lbs. |

FABRIC PRICE CODES

| | | | |
|----------|---------------|-----------|---------------|
| 1 | \$1708 | 8 | \$2329 |
| 2 | \$1816 | 9 | \$2410 |
| 3 | \$1924 | 10 | \$2491 |
| 4 | \$2005 | 11 | \$2572 |
| 5 | \$2086 | 12 | \$2653 |
| 6 | \$2167 | L | \$2608 |
| 7 | \$2248 | | |

NOTES: Standard legs (L) can be adjusted ½" for leveling. Tapered Round and Square legs do not adjust. Tapered support leg molded from high-impact nylon. Both Round and Square Lounge chairs are fully-upholstered.

ⓘ Leg options – Standard Leg (L), Tapered Square (TS) and Tapered Round (TR) are available in Textured Satin Chrome (P6N) and Textured Charcoal (P7A) only. Hard Casters (H) are available on Black (T) only.

HFLRC1

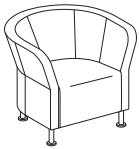

LOUNGE CHAIR

Round

DIMENSIONS

| | | | |
|--------------|-----|-----------------------|----------|
| Depth: | 29 | Arm Width: | 27½ |
| Width: | 33½ | Seat to Floor Height: | 17 |
| Height: | 28 | Usable Seat Depth: | 20½ |
| Seat Depth: | 20½ | Ship Weight: | 57 |
| Seat Width: | 20½ | Cube: | 21.9 |
| Back Width: | 20½ | Weight Rating: | 300 lbs. |
| Back Height: | 18½ | | |

FABRIC PRICE CODES

| | | | |
|----------|---------------|-----------|---------------|
| 1 | \$1785 | 8 | \$2337 |
| 2 | \$1881 | 9 | \$2409 |
| 3 | \$1977 | 10 | \$2481 |
| 4 | \$2049 | 11 | \$2553 |
| 5 | \$2121 | 12 | \$2625 |
| 6 | \$2193 | L | \$2585 |
| 7 | \$2265 | | |

NOTES: Standard legs (L) can be adjusted ½" for leveling. Tapered Round and Square legs do not adjust. Tapered support leg molded from high-impact nylon. Both Round and Square Lounge chairs are fully-upholstered.

ⓘ Round Lounge models HFLRC1 / HFLRC1DF are offered in select fabrics; for availability, please see the Fabric Matrix on page 91. Also approved in limited Partnership Fabrics. Leg options – Standard Leg (L), Tapered Square (TS) and Tapered Round (TR) are available in Textured Satin Chrome (P6N) and Textured Charcoal (P7A) only. Hard Casters (H) are available on Black (T) only.

ⓘ Customer's Own Material (COM) is not available on Flock® model HFLRC1.

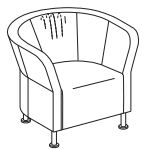

Due to the inherent design of the Round Lounge chair, material gathers will be present in the back.

HON Recommendation: HFLSC1.TS.PNS__P7A - List Price \$1816

HOW TO SPECIFY

| | | | |
|---|--|--|---|
| <p>Select Model Number</p> <p>HFLSC1</p> | <p>Select Leg Option</p> <p>L Standard Leg TS Tapered Square TR Tapered Round H Hard Casters</p> <p>TS</p> | <p>Select Fabric</p> <p>See page 91</p> <p>PNS007</p> | <p>Select Leg Color</p> <p>P6N Textured Satin Chrome P7A Textured Charcoal</p> <p><i>Specify for Standard, Tapered Round and Tapered Square legs only</i></p> <p>T Black Hard Caster <i>Specify for Hard Caster option only</i></p> <p>P7A</p> |
|---|--|--|---|



Icon Legend on page 17

HFLMC1



MODULAR CHAIR

DIMENSIONS

| | | | |
|--------------|-----|-----------------------|----------|
| Depth: | 28½ | Seat to Floor Height: | 17 |
| Width: | 25 | Usable Seat Depth: | 20½ |
| Height: | 28 | Ship Weight: | 54 |
| Seat Depth: | 20½ | Cube: | 21.9 |
| Seat Width: | 25 | COM: | 3.0 |
| Back Width: | 25 | Weight Rating: | 300 lbs. |
| Back Height: | 18½ | | |

FABRIC PRICE CODES

| | | | |
|---|--------|----|--------|
| 1 | \$1251 | 8 | \$1665 |
| 2 | \$1323 | 9 | \$1719 |
| 3 | \$1395 | 10 | \$1773 |
| 4 | \$1449 | 11 | \$1827 |
| 5 | \$1503 | 12 | \$1881 |
| 6 | \$1557 | L | \$1851 |
| 7 | \$1611 | | |

NOTES: Standard legs (L) can be adjusted ½" for leveling. Tapered Round and Square legs do not adjust. Tapered support leg molded from high-impact nylon.

ⓘ Leg options – Standard Leg (L), Tapered Square (TS) and Tapered Round (TR) are available in Textured Satin Chrome (P6N) and Textured Charcoal (P7A) only. Hard Casters (H) are available on Black (T) only.

HFLML1

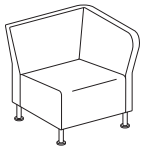

MODULAR

Left End

DIMENSIONS

| | | | |
|--------------|-----|-----------------------|----------|
| Depth: | 28½ | Seat to Floor Height: | 17 |
| Width: | 28½ | Usable Seat Depth: | 20½ |
| Height: | 28 | Ship Weight: | 72 |
| Seat Depth: | 20½ | Cube: | 21.9 |
| Seat Width: | 22¼ | COM: | 4.0 |
| Back Width: | 22¼ | Weight Rating: | 300 lbs. |
| Back Height: | 18½ | | |

FABRIC PRICE CODES

| | | | |
|---|--------|----|--------|
| 1 | \$1477 | 8 | \$2029 |
| 2 | \$1573 | 9 | \$2101 |
| 3 | \$1669 | 10 | \$2173 |
| 4 | \$1741 | 11 | \$2245 |
| 5 | \$1813 | 12 | \$2317 |
| 6 | \$1885 | L | \$2277 |
| 7 | \$1957 | | |

NOTES: Standard legs (L) can be adjusted ½" for leveling. Tapered Round and Square legs do not adjust. Tapered support leg molded from high-impact nylon.

ⓘ Leg options – Standard Leg (L), Tapered Square (TS) and Tapered Round (TR) are available in Textured Satin Chrome (P6N) and Textured Charcoal (P7A) only. Hard Casters (H) are available on Black (T) only.

HFLMR1

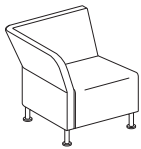

MODULAR

Right End

DIMENSIONS

| | | | |
|--------------|-----|-----------------------|----------|
| Depth: | 28½ | Seat to Floor Height: | 17 |
| Width: | 28½ | Usable Seat Depth: | 20½ |
| Height: | 28 | Ship Weight: | 72 |
| Seat Depth: | 20½ | Cube: | 21.9 |
| Seat Width: | 22¼ | COM: | 4.0 |
| Back Width: | 22¼ | Weight Rating: | 300 lbs. |
| Back Height: | 18½ | | |

FABRIC PRICE CODES

| | | | |
|---|--------|----|--------|
| 1 | \$1477 | 8 | \$2029 |
| 2 | \$1573 | 9 | \$2101 |
| 3 | \$1669 | 10 | \$2173 |
| 4 | \$1741 | 11 | \$2245 |
| 5 | \$1813 | 12 | \$2317 |
| 6 | \$1885 | L | \$2277 |
| 7 | \$1957 | | |

NOTES: Standard legs (L) can be adjusted ½" for leveling. Tapered Round and Square legs do not adjust. Tapered support leg molded from high-impact nylon.

ⓘ Leg options – Standard Leg (L), Tapered Square (TS) and Tapered Round (TR) are available in Textured Satin Chrome (P6N) and Textured Charcoal (P7A) only. Hard Casters (H) are available on Black (T) only.

HON Recommendation: HFLMC1.TS.PNS_..P6N - List Price \$1323

HOW TO SPECIFY

| | | | |
|--|---|---|---|
| <p>Select Model Number</p> <p>H F L M C 1 .</p> | <p>Select Leg Option</p> <p>L Standard Leg TS Tapered Square TR Tapered Round H Hard Casters</p> <p>T S .</p> | <p>Select Fabric</p> <p>See page 91</p> <p>P N S 0 0 7 .</p> | <p>Select Leg Color</p> <p>P6N Textured Satin Chrome P7A Textured Charcoal</p> <p><i>Specify for Standard, Tapered Round and Tapered Square legs only</i></p> <p>T Black Hard Caster <i>Specify for Hard Caster option only</i></p> <p>P 6 N</p> |
|--|---|---|---|



HFLCC1

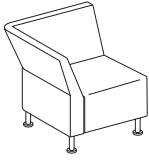

TRUE CORNER CHAIR

DIMENSIONS

| | | | |
|--------------|-----|-----------------------|----------|
| Depth: | 28½ | Seat to Floor Height: | 17 |
| Width: | 28½ | Usable Seat Depth: | 20½ |
| Height: | 28 | Ship Weight: | 60 |
| Seat Depth: | 20½ | Cube: | 21.9 |
| Seat Width: | 20½ | COM: | 4.0 |
| Back Width: | 22¼ | Weight Rating: | 300 lbs. |
| Back Height: | 18½ | | |

FABRIC PRICE CODES

| | | | |
|----------|---------------|-----------|---------------|
| 1 | \$1469 | 8 | \$2253 |
| 2 | \$1565 | 9 | \$2377 |
| 3 | \$1661 | 10 | \$2501 |
| 4 | \$1757 | 11 | \$2625 |
| 5 | \$1881 | 12 | \$2749 |
| 6 | \$2005 | L | \$2269 |
| 7 | \$2129 | | |

NOTES: Standard legs (L) can be adjusted ½" for leveling. Tapered Round and Square legs do not adjust. Tapered support leg molded from high-impact nylon.

ⓘ Leg options – Standard Leg (L), Tapered Square (TS) and Tapered Round (TR) are available in Textured Satin Chrome (P6N) and Textured Charcoal (P7A) only.

HFLWI45

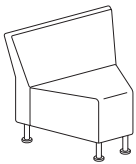

INSIDE WEDGE

DIMENSIONS

| | | | |
|--------------|-----|-----------------------|----------|
| Depth: | 26¼ | Seat to Floor Height: | 17 |
| Width: | 31½ | Usable Seat Depth: | 19 |
| Height: | 28 | Ship Weight: | 45 |
| Seat Depth: | 19½ | Cube: | 21.9 |
| Seat Width: | 25¾ | COM: | 3.0 |
| Back Width: | 31½ | Weight Rating: | 300 lbs. |
| Back Height: | 18½ | | |

FABRIC PRICE CODES

| | | | |
|----------|---------------|-----------|---------------|
| 1 | \$1469 | 8 | \$2253 |
| 2 | \$1565 | 9 | \$2377 |
| 3 | \$1661 | 10 | \$2501 |
| 4 | \$1757 | 11 | \$2625 |
| 5 | \$1881 | 12 | \$2749 |
| 6 | \$2005 | L | \$2269 |
| 7 | \$2129 | | |

NOTES: Standard legs (L) can be adjusted ½" for leveling. Tapered Round and Square legs do not adjust. Tapered support leg molded from high-impact nylon.

ⓘ Leg options – Standard Leg (L), Tapered Square (TS) and Tapered Round (TR) are available in Textured Satin Chrome (P6N) and Textured Charcoal (P7A) only.

HFLWO45

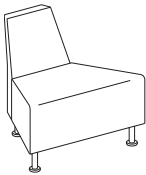

OUTSIDE WEDGE

DIMENSIONS

| | | | |
|--------------|-----|-----------------------|----------|
| Depth: | 26½ | Seat to Floor Height: | 17 |
| Width: | 32 | Usable Seat Depth: | 19 |
| Height: | 28 | Ship Weight: | 35 |
| Seat Depth: | 19½ | Cube: | 21.9 |
| Seat Width: | 32 | COM: | 3.0 |
| Back Width: | 16¼ | Weight Rating: | 300 lbs. |
| Back Height: | 18½ | | |

FABRIC PRICE CODES

| | | | |
|----------|---------------|-----------|---------------|
| 1 | \$1469 | 8 | \$2253 |
| 2 | \$1565 | 9 | \$2377 |
| 3 | \$1661 | 10 | \$2501 |
| 4 | \$1757 | 11 | \$2625 |
| 5 | \$1881 | 12 | \$2749 |
| 6 | \$2005 | L | \$2269 |
| 7 | \$2129 | | |

NOTES: Standard legs (L) can be adjusted ½" for leveling. Tapered Round and Square legs do not adjust. Tapered support leg molded from high-impact nylon.

ⓘ Leg options – Standard Leg (L), Tapered Square (TS) and Tapered Round (TR) are available in Textured Satin Chrome (P6N) and Textured Charcoal (P7A) only.

HON Recommendation: HFLCC1.TS.PNS__P6N - List Price \$1469

HOW TO SPECIFY

| | | | |
|---|--|--|---|
| <p>Select Model Number</p> <p>HFLCC1</p> | <p>Select Leg Option</p> <p>L Standard Leg TS Tapered Square TR Tapered Round</p> <p>TS</p> | <p>Select Fabric</p> <p>See page 91</p> <p>PNS007</p> | <p>Select Leg Color</p> <p>P6N Textured Satin Chrome P7A Textured Charcoal</p> <p><i>Specify for Standard, Tapered Round and Tapered Square legs only</i></p> <p>P6N</p> |
|---|--|--|---|



HFL450

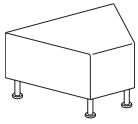

WEDGE OTTOMAN

DIMENSIONS

| | | | |
|-----------------------|-----|--------------------|----------|
| Depth: | 23½ | Usable Seat Depth: | 23½ |
| Width: | 32 | Ship Weight: | 33 |
| Height: | 17 | Cube: | 12.6 |
| Seat Depth: | 23½ | COM: | 2.0 |
| Seat Width: | 32 | Weight Rating: | 300 lbs. |
| Seat to Floor Height: | 17 | | |

FABRIC PRICE CODES

| | | | |
|----------|---------------|-----------|---------------|
| 1 | \$719 | 8 | \$1111 |
| 2 | \$767 | 9 | \$1173 |
| 3 | \$815 | 10 | \$1235 |
| 4 | \$863 | 11 | \$1297 |
| 5 | \$925 | 12 | \$1359 |
| 6 | \$987 | L | \$1119 |
| 7 | \$1049 | | |

NOTES: Standard legs (L) can be adjusted ½" for leveling. Tapered Round and Square legs do not adjust. Tapered support leg molded from high-impact nylon.

ⓘ Leg options – Standard Leg (L), Tapered Square (TS) and Tapered Round (TR) are available in Textured Satin Chrome (P6N) and Textured Charcoal (P7A) only.

HFLS01

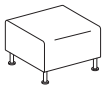

OTTOMAN

Square

DIMENSIONS

| | | | |
|-------------|----|----------------|----------|
| Depth: | 25 | Ship Weight: | 30.0 |
| Width: | 25 | Cube: | 7.5 |
| Height: | 17 | COM: | 2.0 |
| Seat Depth: | 25 | Weight Rating: | 300 lbs. |
| Seat Width: | 25 | | |

FABRIC PRICE CODES

| | | | |
|----------|--------------|-----------|---------------|
| 1 | \$723 | 8 | \$999 |
| 2 | \$771 | 9 | \$1035 |
| 3 | \$819 | 10 | \$1071 |
| 4 | \$855 | 11 | \$1107 |
| 5 | \$891 | 12 | \$1143 |
| 6 | \$927 | L | \$1123 |
| 7 | \$963 | | |

NOTES: Standard legs (L) can be adjusted ½" for leveling. Tapered Round and Square legs do not adjust. Tapered support leg molded from high-impact nylon.

ⓘ Leg options – Standard Leg (L), Tapered Square (TS) and Tapered Round (TR) are available in Textured Satin Chrome (P6N) and Textured Charcoal (P7A) only. Hard Casters (H) are available on Black (T) only.

HFLGANG

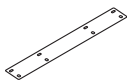

GANGING BRACKET

For Flock® Modular Seating Models

- Can be used for in-line ganging ONLY
- Use one bracket to connect two models. Do not connect more than four models (models HFLMC1, HFLML1, HFLMR1, or HFLS01).
- No specification required for bracket

DIMENSIONS

| | |
|--------------|-----|
| Ship Weight: | 0.5 |
| Cube: | 0.1 |

LIST PRICE

\$32

HON Recommendation: HFLS01.TS.PNS__P6N - List Price \$771

HOW TO SPECIFY

| | | | |
|--|---|---|---|
| <p>Select Model Number</p> <p>H F L S O 1</p> | <p>Select Leg Option</p> <p>L Standard Leg TS Tapered Square TR Tapered Round H Hard Casters</p> <p>T S</p> | <p>Select Fabric</p> <p>See page 91</p> <p>P N S 0 0 7</p> | <p>Select Leg Color</p> <p>P6N Textured Satin Chrome P7A Textured Charcoal</p> <p><i>Specify for Standard, Tapered Round and Tapered Square legs only</i></p> <p>T Black Hard Caster <i>Specify for Hard Caster option only</i></p> <p>P 6 N</p> |
|--|---|---|---|



HFLSC1S

SQUARE LOUNGE CHAIR W/ SWIVEL BASE

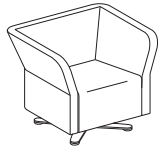

X-Base

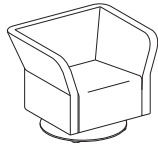

Disc Base

DIMENSIONS

| | | | |
|--------------|---------------------------------|---------------------------|--------------------------------|
| Depth: | 28 ⁹ / ₁₆ | Arm Width: | 27 ¹ / ₂ |
| Width: | 34 ³ / ₃₂ | Seat to Floor Height: | 17 |
| Height: | 28 | Usable Seat Depth: | 20 ¹ / ₂ |
| Seat Depth: | 20 ⁷ / ₃₂ | Ship Weight (X-base): | 116 |
| Seat Width: | 21 ¹ / ₂ | Ship Weight (Round base): | 148 |
| Back Width: | 21 ¹ / ₂ | Cube: | 21.9 |
| Back Height: | 18 ¹ / ₂ | COM: | 5.0 |
| | | Weight Rating: | 300 lbs. |

FABRIC PRICE CODES

| | | | |
|---|--------|----|--------|
| 1 | \$2066 | 8 | \$2687 |
| 2 | \$2174 | 9 | \$2768 |
| 3 | \$2282 | 10 | \$2849 |
| 4 | \$2363 | 11 | \$2930 |
| 5 | \$2444 | 12 | \$3011 |
| 6 | \$2525 | L | \$2966 |
| 7 | \$2606 | | |

NOTES: Standard legs (L) can be adjusted 1/2" for leveling. Tapered Round and Square legs do not adjust. Tapered support leg molded from high-impact nylon.

ⓘ Leg options – X Base (X) and Disc Base (D) are available in Textured Satin Chrome (P6N) and Textured Charcoal (P7A) only.

HFLRC1S

ROUND LOUNGE CHAIR W/ SWIVEL BASE

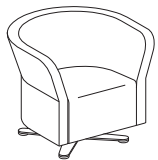

X-Base

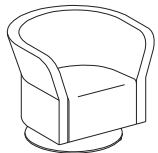

Disc Base

DIMENSIONS

| | | | |
|--------------|---------------------------------|---------------------------|--------------------------------|
| Depth: | 29 ¹ / ₁₆ | Arm Width: | 27 ¹ / ₂ |
| Width: | 33 ³ / ₃₂ | Seat to Floor Height: | 17 |
| Height: | 28 | Usable Seat Depth: | 20 ¹ / ₂ |
| Seat Depth: | 20 ¹ / ₂ | Ship Weight (X-base): | 94 |
| Seat Width: | 20 ¹ / ₂ | Ship Weight (Round base): | 126 |
| Back Width: | 20 ¹ / ₂ | Cube: | 21.9 |
| Back Height: | 18 ¹ / ₂ | Weight Rating: | 300 lbs. |

FABRIC PRICE CODES

| | | | |
|---|--------|----|--------|
| 1 | \$2143 | 8 | \$2695 |
| 2 | \$2239 | 9 | \$2767 |
| 3 | \$2335 | 10 | \$2839 |
| 4 | \$2407 | 11 | \$2911 |
| 5 | \$2479 | 12 | \$2983 |
| 6 | \$2551 | L | \$2943 |
| 7 | \$2623 | | |

NOTES: Standard legs (L) can be adjusted 1/2" for leveling. Tapered Round and Square legs do not adjust. Tapered support leg molded from high-impact nylon.

ⓘ Leg options – X Base (X) and Disc Base (D) are available in Textured Satin Chrome (P6N) and Textured Charcoal (P7A) only.

HFLMC1S

MODULAR CHAIR W/ SWIVEL BASE



X-Base

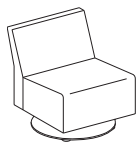

Disc Base

DIMENSIONS

| | | | |
|--------------|--------------------------------|---------------------------|--------------------------------|
| Depth: | 28 ¹ / ₂ | Seat to Floor Height: | 17 |
| Width: | 25 | Usable Seat Depth: | 20 ¹ / ₂ |
| Height: | 28 | Ship Weight (X-base): | 91 |
| Seat Depth: | 20 ¹ / ₂ | Ship Weight (Round base): | 123 |
| Seat Width: | 25 | Cube: | 21.9 |
| Back Width: | 25 | COM: | 3.0 |
| Back Height: | 18 ¹ / ₂ | Weight Rating: | 300 lbs. |

FABRIC PRICE CODES

| | | | |
|---|--------|----|--------|
| 1 | \$1612 | 8 | \$2026 |
| 2 | \$1684 | 9 | \$2080 |
| 3 | \$1756 | 10 | \$2134 |
| 4 | \$1810 | 11 | \$2188 |
| 5 | \$1864 | 12 | \$2242 |
| 6 | \$1918 | L | \$2212 |
| 7 | \$1972 | | |

NOTES: Standard legs (L) can be adjusted 1/2" for leveling. Tapered Round and Square legs do not adjust. Tapered support leg molded from high-impact nylon.

ⓘ Leg options – X Base (X) and Disc Base (D) are available in Textured Satin Chrome (P6N) and Textured Charcoal (P7A) only.

HOW TO SPECIFY HON Recommendation: HFLMC1S.X.PNS__P6N - List Price \$1612

| | | | |
|--|---|---|---|
| <p>Select Model Number</p> <p>H F L M C 1 S .</p> | <p>Select Swivel Option</p> <p>X X Base D Disc Base</p> <p>X .</p> | <p>Select Fabric</p> <p>See page 91</p> <p>P N S 0 0 7 .</p> | <p>Select Base Color</p> <p>P6N Textured Satin Chrome P7A Textured Charcoal</p> <p>P 6 N</p> |
|--|---|---|---|



Icon Legend on page 17

FLOCK® Dual Fabric Collaborative

HFLSC1DF

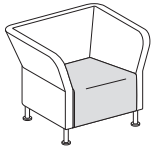

LOUNGE CHAIR

Dual Fabric
Square

DIMENSIONS

| | | | |
|--------------|-----|-----------------------|--------------|
| Depth: | 28½ | Arm Width: | 27½ |
| Width: | 34¼ | Seat to Floor Height: | 17 |
| Height: | 28 | Usable Seat Depth: | 20½ |
| Seat Depth: | 20½ | Ship Weight: | 48 |
| Seat Width: | 21½ | Cube: | 27.0 |
| Back Width: | 21½ | COM: | See page 108 |
| Back Height: | 18½ | Weight Rating: | 300 lbs. |

FABRIC PRICE CODES

| | | |
|--------------------------------|---------------|--------------|
| 1 | \$1783 | |
| <i>Add to Base Price Above</i> | | |
| | Back | Seat |
| 2 | \$80 | \$28 |
| 3 | \$160 | \$56 |
| 4 | \$220 | \$77 |
| 5 | \$280 | \$98 |
| 6 | \$340 | \$119 |
| 7 | \$400 | \$140 |
| 8 | \$460 | \$161 |
| 9 | \$519 | \$183 |
| 10 | \$579 | \$204 |
| 11 | \$639 | \$225 |
| 12 | \$699 | \$246 |
| L | \$666 | \$234 |

For dual fabric models, start with the base price, then add the additional amount for the back and seat from the corresponding matrix to determine the final list price. Choose any combination of fabric grades for the back and seat.

Example: HFLSC1DF base price (\$1783) + Grade 2 back fabric (add \$80) + Grade 4 seat fabric (add \$77) = Total \$1940 List
 HFLSC1DF base price (\$1783) + Grade 5 back fabric (add \$280) + Grade 3 seat fabric (add \$56) = Total \$2119 List

HFLRC1DF

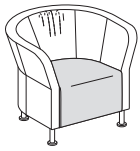

LOUNGE CHAIR

Dual Fabric
Round

DIMENSIONS

| | | | |
|--------------|-----|-----------------------|----------|
| Depth: | 29 | Arm Width: | 27½ |
| Width: | 33½ | Seat to Floor Height: | 17 |
| Height: | 28 | Usable Seat Depth: | 20½ |
| Seat Depth: | 20½ | Ship Weight: | 39 |
| Seat Width: | 20½ | Cube: | 27.0 |
| Back Width: | 20½ | Weight Rating: | 300 lbs. |
| Back Height: | 18½ | | |

FABRIC PRICE CODES

| | | |
|--------------------------------|---------------|--------------|
| 1 | \$1860 | |
| <i>Add to Base Price Above</i> | | |
| | Back | Seat |
| 2 | \$71 | \$25 |
| 3 | \$142 | \$50 |
| 4 | \$195 | \$69 |
| 5 | \$249 | \$87 |
| 6 | \$302 | \$106 |
| 7 | \$355 | \$125 |
| 8 | \$408 | \$144 |
| 9 | \$462 | \$162 |
| 10 | \$515 | \$181 |
| 11 | \$568 | \$200 |
| 12 | \$622 | \$218 |
| L | \$592 | \$208 |

NOTES: Due to the inherent design of the Round Lounge chair, material gathers will be present in the back.

! Round Lounge models HFLRC1 / HFLRC1DF are offered in select fabrics; for availability, please see the Fabric Matrix on page 91. Also approved in limited Partnership Fabrics.

For dual fabric models, start with the base price, then add the additional amount for the back and seat from the corresponding matrix to determine the final list price. Choose any combination of fabric grades for the back and seat.

Example: HFLRC1DF base price (\$1860) + Grade 2 back fabric (add \$71) + Grade 4 seat fabric (add \$69) = Total \$2000 List
 HFLRC1DF base price (\$1860) + Grade 5 back fabric (add \$249) + Grade 3 seat fabric (add \$50) = Total \$2159 List

HON Recommendation: HFLSC1DF.TS.PNS___.PNS___.P6N - List Price \$1891

HOW TO SPECIFY

| | | | | |
|-----------------------------------|--|---|---|--|
| <p>Select Model Number</p> | <p>Select Leg Option</p> <p>L Standard Leg TS Tapered Square TR Tapered Round H Hard Casters</p> | <p>Select Back Fabric</p> <p>See page 91</p> | <p>Select Seat Fabric</p> <p>See page 91</p> | <p>Select Leg Color</p> <p>P6N Textured Satin Chrome P7A Textured Charcoal</p> <p><i>Specify for Standard, Tapered Round and Tapered Square legs only</i></p> <p>T Black Hard Caster</p> <p><i>Specify for Hard Caster option only</i></p> |
| HFLSC1DF . | TS . | PNS004 . | PNS007 . | P6N |

FLOCK® Dual Fabric Collaborative

GSA SIN 711-17



Icon Legend on page 17

HFLMC1DF

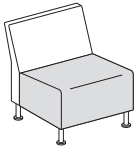

MODULAR CHAIR

Dual Fabric

DIMENSIONS

| | | | |
|--------------|-----|-----------------------|--------------|
| Depth: | 28½ | Seat to Floor Height: | 17 |
| Width: | 25 | Usable Seat Depth: | 20½ |
| Height: | 28 | Ship Weight: | 52 |
| Seat Depth: | 20½ | Cube: | 24.0 |
| Seat Width: | 25 | COM: | See page 108 |
| Back Width: | 25 | Weight Rating: | 300 lbs. |
| Back Height: | 18½ | | |

FABRIC PRICE CODES

| | | |
|-----------|--------------------------------|--------------|
| 1 | \$1326 | |
| | <i>Add to Base Price Above</i> | |
| | Back | Seat |
| 2 | \$36 | \$36 |
| 3 | \$72 | \$72 |
| 4 | \$99 | \$99 |
| 5 | \$126 | \$126 |
| 6 | \$153 | \$153 |
| 7 | \$180 | \$180 |
| 8 | \$207 | \$207 |
| 9 | \$234 | \$234 |
| 10 | \$261 | \$261 |
| 11 | \$288 | \$288 |
| 12 | \$315 | \$315 |
| L | \$300 | \$300 |

HFLML1DF

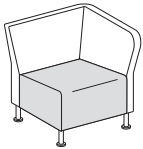

MODULAR LEFT END

Dual Fabric

DIMENSIONS

| | | | |
|--------------|-----|-----------------------|--------------|
| Depth: | 28½ | Seat to Floor Height: | 17 |
| Width: | 28½ | Usable Seat Depth: | 20½ |
| Height: | 28 | Ship Weight: | 72 |
| Seat Depth: | 20½ | Cube: | 24.0 |
| Seat Width: | 22¼ | COM: | See page 108 |
| Back Width: | 22¼ | Weight Rating: | 300 lbs. |
| Back Height: | 18½ | | |

FABRIC PRICE CODES

| | | |
|-----------|--------------------------------|--------------|
| 1 | \$1552 | |
| | <i>Add to Base Price Above</i> | |
| | Back | Seat |
| 2 | \$71 | \$25 |
| 3 | \$142 | \$50 |
| 4 | \$195 | \$69 |
| 5 | \$249 | \$87 |
| 6 | \$302 | \$106 |
| 7 | \$355 | \$125 |
| 8 | \$408 | \$144 |
| 9 | \$462 | \$162 |
| 10 | \$515 | \$181 |
| 11 | \$568 | \$200 |
| 12 | \$622 | \$218 |
| L | \$592 | \$208 |

HON Recommendation: HFLMC1DF.TS.PNS__PNS__P6N - List Price \$1398

HOW TO SPECIFY

| | | | | |
|---|---|---|---|--|
| Select Model Number <div style="border: 1px solid black; display: flex; justify-content: space-between; padding: 2px;"> HFLMC1DF </div> | Select Leg Option <ul style="list-style-type: none"> L Standard Leg TS Tapered Square TR Tapered Round H Hard Casters <div style="border: 1px solid black; display: flex; justify-content: space-between; padding: 2px;"> TS </div> | Select Back Fabric See page 91 <div style="border: 1px solid black; display: flex; justify-content: space-between; padding: 2px;"> PNS004 </div> | Select Seat Fabric See page 91 <div style="border: 1px solid black; display: flex; justify-content: space-between; padding: 2px;"> PNS007 </div> | Select Leg Color <ul style="list-style-type: none"> P6N Textured Satin Chrome P7A Textured Charcoal <p><i>Specify for Standard, Tapered Round and Tapered Square legs only</i></p> <ul style="list-style-type: none"> T Black Hard Caster <p><i>Specify for Hard Caster option only</i></p> <div style="border: 1px solid black; display: flex; justify-content: space-between; padding: 2px;"> P6N </div> |
|---|---|---|---|--|



FLOCK® Dual Fabric Collaborative

HFLMR1DF

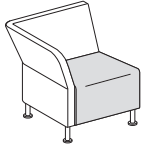

MODULAR RIGHT END

Dual Fabric

DIMENSIONS

| | | | |
|--------------|-----|-----------------------|--------------|
| Depth: | 28½ | Seat to Floor Height: | 17 |
| Width: | 28½ | Usable Seat Depth: | 20½ |
| Height: | 28 | Ship Weight: | 72.0 |
| Seat Depth: | 20½ | Cube: | 24.0 |
| Seat Width: | 22¼ | COM: | See page 108 |
| Back Width: | 22¼ | Weight Rating: | 300 lbs. |
| Back Height: | 18½ | | |

FABRIC PRICE CODES

| | | |
|--------------------------------|---------------|--------------|
| 1 | \$1552 | |
| <i>Add to Base Price Above</i> | | |
| | Back | Seat |
| 2 | \$71 | \$25 |
| 3 | \$142 | \$50 |
| 4 | \$195 | \$69 |
| 5 | \$249 | \$87 |
| 6 | \$302 | \$106 |
| 7 | \$355 | \$125 |
| 8 | \$408 | \$144 |
| 9 | \$462 | \$162 |
| 10 | \$515 | \$181 |
| 11 | \$568 | \$200 |
| 12 | \$622 | \$218 |
| L | \$592 | \$208 |

HFLGANG

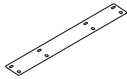

GANGING BRACKET

For Flock® Modular Seating Models

- Can be used for in-line ganging ONLY
- Use one bracket to connect two models. Do not connect more than four models (models HFLMC1DF, HFLML1DF or HFLMR1DF).
- No specification required for bracket

DIMENSIONS

| | |
|--------------|-----|
| Ship Weight: | 0.5 |
| Cube: | 0.1 |

LIST PRICE

\$32

HON Recommendation: HFLMR1DF.TS.PNS__PNS__P6N - List Price \$1648

HOW TO SPECIFY

| | | | | |
|-----------------------------------|--|---|---|---|
| <p>Select Model Number</p> | <p>Select Leg Option</p> <p>L Standard Leg TS Tapered Square TR Tapered Round H Hard Casters</p> | <p>Select Back Fabric</p> <p>See page 91</p> | <p>Select Seat Fabric</p> <p>See page 91</p> | <p>Select Leg Color</p> <p>P6N Textured Satin Chrome P7A Textured Charcoal</p> <p><i>Specify for Standard, Tapered Round and Tapered Square legs only</i></p> <p>T Black Hard Caster <i>Specify for Hard Caster option only</i></p> |
| <p>H F L M R 1 D F .</p> | <p>T S .</p> | <p>P N S 0 0 4 .</p> | <p>P N S 0 0 7 .</p> | <p>P 6 N</p> |

FLOCK® Dual Fabric Collaborative

GSA SIN 711-17



Icon Legend on page 17

HFLCC1DF

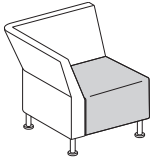

TRUE CORNER CHAIR

Dual Fabric

DIMENSIONS

| | | | |
|--------------|-----|-----------------------|----------|
| Depth: | 28½ | Seat to Floor Height: | 17 |
| Width: | 28½ | Usable Seat Depth: | 21 |
| Height: | 28 | Ship Weight: | 60 |
| Seat Depth: | 20½ | Cube: | 21.9 |
| Seat Width: | 20½ | COM: | 4.0 |
| Back Width: | 22¼ | Weight Rating: | 300 lbs. |
| Back Height: | 18½ | | |

FABRIC PRICE CODES

| | | |
|-----------|--------------------------------|--------------|
| 1 | \$1544 | |
| | <i>Add to Base Price Above</i> | |
| | Back | Seat |
| 2 | \$48 | \$48 |
| 3 | \$96 | \$96 |
| 4 | \$144 | \$144 |
| 5 | \$206 | \$206 |
| 6 | \$268 | \$268 |
| 7 | \$330 | \$330 |
| 8 | \$392 | \$392 |
| 9 | \$454 | \$454 |
| 10 | \$516 | \$516 |
| 11 | \$578 | \$578 |
| 12 | \$640 | \$640 |
| L | \$400 | \$400 |

NOTES: Standard legs (L) can be adjusted ½" for leveling. Tapered Round and Square legs do not adjust. Tapered support leg molded from high-impact nylon.

! Leg options – Standard Leg (L), Tapered Square (TS) and Tapered Round (TR) are available in Textured Satin Chrome (P6N) and Textured Charcoal (P7A) only. Hard Casters (H) are available on Black (T) only.

HFLWI45DF

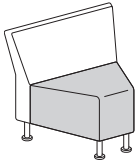

INSIDE WEDGE

Dual Fabric

DIMENSIONS

| | | | |
|--------------|-----|-----------------------|----------|
| Depth: | 26¼ | Seat to Floor Height: | 17 |
| Width: | 31½ | Usable Seat Depth: | 19 |
| Height: | 28 | Ship Weight: | 45 |
| Seat Depth: | 19½ | Cube: | 21.9 |
| Seat Width: | 25¾ | COM: | 3.0 |
| Back Width: | 31½ | Weight Rating: | 300 lbs. |
| Back Height: | 18½ | | |

FABRIC PRICE CODES

| | | |
|-----------|--------------------------------|--------------|
| 1 | \$1544 | |
| | <i>Add to Base Price Above</i> | |
| | Back | Seat |
| 2 | \$48 | \$48 |
| 3 | \$96 | \$96 |
| 4 | \$144 | \$144 |
| 5 | \$206 | \$206 |
| 6 | \$268 | \$268 |
| 7 | \$330 | \$330 |
| 8 | \$392 | \$392 |
| 9 | \$454 | \$454 |
| 10 | \$516 | \$516 |
| 11 | \$578 | \$578 |
| 12 | \$640 | \$640 |
| L | \$400 | \$400 |

NOTES: Standard legs (L) can be adjusted ½" for leveling. Tapered Round and Square legs do not adjust. Tapered support leg molded from high-impact nylon.

! Leg options – Standard Leg (L), Tapered Square (TS) and Tapered Round (TR) are available in Textured Satin Chrome (P6N) and Textured Charcoal (P7A) only. Hard Casters (H) are available on Black (T) only.

HFLWO45DF

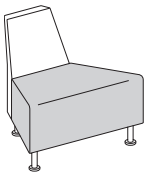

OUTSIDE WEDGE

Dual Fabric

DIMENSIONS

| | | | |
|--------------|-----|-----------------------|----------|
| Depth: | 26½ | Seat to Floor Height: | 17 |
| Width: | 32 | Usable Seat Depth: | 19 |
| Height: | 28 | Ship Weight: | 35 |
| Seat Depth: | 19½ | Cube: | 21.9 |
| Seat Width: | 32 | COM: | 3.0 |
| Back Width: | 16¼ | Weight Rating: | 300 lbs. |
| Back Height: | 18½ | | |

FABRIC PRICE CODES

| | | |
|-----------|--------------------------------|--------------|
| 1 | \$1544 | |
| | <i>Add to Base Price Above</i> | |
| | Back | Seat |
| 2 | \$48 | \$48 |
| 3 | \$96 | \$96 |
| 4 | \$144 | \$144 |
| 5 | \$206 | \$206 |
| 6 | \$268 | \$268 |
| 7 | \$330 | \$330 |
| 8 | \$392 | \$392 |
| 9 | \$454 | \$454 |
| 10 | \$516 | \$516 |
| 11 | \$578 | \$578 |
| 12 | \$640 | \$640 |
| L | \$400 | \$400 |

NOTES: Standard legs (L) can be adjusted ½" for leveling. Tapered Round and Square legs do not adjust. Tapered support leg molded from high-impact nylon.

! Leg options – Standard Leg (L), Tapered Square (TS) and Tapered Round (TR) are available in Textured Satin Chrome (P6N) and Textured Charcoal (P7A) only. Hard Casters (H) are available on Black (T) only.

HOW TO SPECIFY **HON Recommendation: HFLCC1DF.TS.PNS__PNS__P6N - List Price \$1640**

| | | | | |
|--|---|--|--|---|
| Select Model Number HFLCC1DF | Select Leg Option L Standard Leg TS Tapered Square TR Tapered Round H Hard Casters | Select Back Fabric See page 91 | Select Seat Fabric See page 91 | Select Leg Color P6N Textured Satin Chrome P7A Textured Charcoal <i>Specify for Standard, Tapered Round and Tapered Square legs only</i> T Black Hard Caster <i>Specify for Hard Caster option only</i> |
| HFLCC1DF. | TS. | PNS004. | PNS007. | P6N |

HFLSC1SDF



X-Base

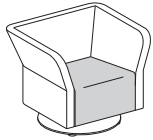

Disc Base

SQUARE LOUNGE CHAIR W/ SWIVEL BASE

Dual Fabric

DIMENSIONS

| | | | |
|--------------|----------------------------------|---------------------------|--------------------------------|
| Depth: | 28 ⁹ / ₁₆ | Arm Width: | 27 ¹ / ₂ |
| Width: | 34 ³ / ₃₂ | Seat to Floor Height: | 17 |
| Height: | 28 | Usable Seat Depth: | 20 ¹ / ₂ |
| Seat Depth: | 20 ¹⁷ / ₃₂ | Ship Weight (X-base): | 116 |
| Seat Width: | 21 ¹ / ₂ | Ship Weight (Round base): | 148 |
| Back Width: | 21 ¹ / ₂ | Cube: | 21.9 |
| Back Height: | 18 ¹ / ₂ | COM: | 5.0 |
| | | Weight Rating: | 300 lbs. |

FABRIC PRICE CODES

| | | | |
|--------------------------------|--------|-------------|-------------|
| 1 | \$2141 | | |
| <i>Add to Base Price Above</i> | | | |
| | | Back | Seat |
| 2 | \$80 | \$28 | |
| 3 | \$160 | \$56 | |
| 4 | \$220 | \$77 | |
| 5 | \$280 | \$98 | |
| 6 | \$340 | \$119 | |
| 7 | \$400 | \$140 | |
| 8 | \$460 | \$161 | |
| 9 | \$519 | \$183 | |
| 10 | \$579 | \$204 | |
| 11 | \$639 | \$225 | |
| 12 | \$699 | \$246 | |
| L | \$666 | \$234 | |

NOTES: Standard legs (L) can be adjusted 1/2" for leveling. Tapered Round and Square legs do not adjust. Tapered support leg molded from high-impact nylon.
 ⚠ Leg options – X Base (X) and Disc Base (D) are available in Textured Satin Chrome (P6N) and Textured Charcoal (P7A) only.

HFLRC1SDF



X-Base

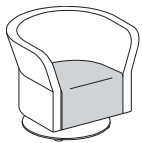

Disc Base

ROUND LOUNGE CHAIR W/ SWIVEL BASE

Dual Fabric

DIMENSIONS

| | | | |
|--------------|---------------------------------|---------------------------|--------------------------------|
| Depth: | 29 ¹ / ₁₆ | Arm Width: | 27 ¹ / ₂ |
| Width: | 33 ⁵ / ₃₂ | Seat to Floor Height: | 17 |
| Height: | 28 | Usable Seat Depth: | 20 ¹ / ₂ |
| Seat Depth: | 20 ¹ / ₂ | Ship Weight (X-base): | 94 |
| Seat Width: | 20 ¹ / ₂ | Ship Weight (Round base): | 126 |
| Back Width: | 20 ¹ / ₂ | Cube: | 21.9 |
| Back Height: | 18 ¹ / ₂ | Weight Rating: | 300 lbs. |

FABRIC PRICE CODES

| | | | |
|--------------------------------|--------|-------------|-------------|
| 1 | \$2218 | | |
| <i>Add to Base Price Above</i> | | | |
| | | Back | Seat |
| 2 | \$71 | \$25 | |
| 3 | \$142 | \$50 | |
| 4 | \$195 | \$69 | |
| 5 | \$249 | \$87 | |
| 6 | \$302 | \$106 | |
| 7 | \$355 | \$125 | |
| 8 | \$408 | \$144 | |
| 9 | \$462 | \$162 | |
| 10 | \$515 | \$181 | |
| 11 | \$568 | \$200 | |
| 12 | \$622 | \$218 | |
| L | \$592 | \$208 | |

NOTES: Standard legs (L) can be adjusted 1/2" for leveling. Tapered Round and Square legs do not adjust. Tapered support leg molded from high-impact nylon.
 ⚠ Leg options – X Base (X) and Disc Base (D) are available in Textured Satin Chrome (P6N) and Textured Charcoal (P7A) only.

HFLMC1SDF



X-Base

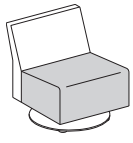

Disc Base

MODULAR CHAIR W/ SWIVEL BASE

Dual Fabric

DIMENSIONS

| | | | |
|--------------|--------------------------------|---------------------------|--------------------------------|
| Depth: | 28 ¹ / ₂ | Seat to Floor Height: | 17 |
| Width: | 25 | Usable Seat Depth: | 20 ¹ / ₂ |
| Height: | 28 ¹ / ₂ | Ship Weight (X-base): | 91 |
| Seat Depth: | 20 ¹ / ₂ | Ship Weight (Round base): | 123 |
| Seat Width: | 25 | Cube: | 21.9 |
| Back Width: | 25 | COM: | 3.0 |
| Back Height: | 18 ¹ / ₂ | Weight Rating: | 300 lbs. |

FABRIC PRICE CODES

| | | | |
|--------------------------------|--------|-------------|-------------|
| 1 | \$1687 | | |
| <i>Add to Base Price Above</i> | | | |
| | | Back | Seat |
| 2 | \$36 | \$36 | |
| 3 | \$72 | \$72 | |
| 4 | \$99 | \$99 | |
| 5 | \$126 | \$126 | |
| 6 | \$153 | \$153 | |
| 7 | \$180 | \$180 | |
| 8 | \$207 | \$207 | |
| 9 | \$234 | \$234 | |
| 10 | \$261 | \$261 | |
| 11 | \$288 | \$288 | |
| 12 | \$315 | \$315 | |
| L | \$300 | \$300 | |

NOTES: Standard legs (L) can be adjusted 1/2" for leveling. Tapered Round and Square legs do not adjust. Tapered support leg molded from high-impact nylon.
 ⚠ Leg options – X Base (X) and Disc Base (D) are available in Textured Satin Chrome (P6N) and Textured Charcoal (P7A) only.

HON Recommendation: HFLMC1SDF.X.PNS__PNS__P6N - List Price \$1759

HOW TO SPECIFY

| | | | | |
|---|--|--|--|--|
| Select Model Number H F L M C 1 S D F | Select Swivel Option X X Base D Disc Base | Select Back Fabric See page 91 | Select Seat Fabric See page 91 | Select Base Color P6N Textured Satin Chrome P7A Textured Charcoal |
| H F L M C 1 S D F | X | P N S 0 0 4 | P N S 0 0 7 | P 6 N |

FLOCK® Options

MODEL OPTIONS

HFSS7

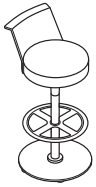

Stool

HFSG6
HFSG6DF - Dual Fabric



Guest Chair
Casual

HFCL1
HFCL1DF - Dual Fabric



Lounge Chair
Casual

HFSS74L
HFSS74LDF - Dual Fabric



Stool
4-Leg

SHELL COLOR

| CODE | DESCRIPTION | PRICE |
|-----------|-------------|-------------|
| LA | Lava | +\$0 |
| ON | Onyx | +\$0 |
| PT | Platinum | +\$0 |
| SD | Shadow | +\$0 |

**Available for model HFSS7 only*

FRAME

| CODE | DESCRIPTION | PRICE |
|------------|-----------------------|-------------|
| P6N | Textured Satin Chrome | +\$0 |
| P7A | Textured Charcoal | +\$0 |

**P7A available for model HFSS7 only*

HON BRANDED FABRICS

| GRADE 1 | GRADE 2 | GRADE 3 | GRADE L |
|--------------------------|-----------------|------------------|----------------|
| Attire | Appoint Seating | In Season | Denver Leather |
| Centurion | Clyde | Purl | |
| Compass | Dotty | Silvertex™ Vinyl | |
| Contourette Polyurethane | Rush | | |
| Dapper | Seed | | |
| Hamilton | Spin Seating | | |
| Inertia | Whisper Vinyl | | |
| Optic | | | |

For a complete list of fabrics, including partnership fabrics, go to hon.com/fabricsandfinishes.

Flock® chair models HFLRC1 and HFLRC1DF have fabric limitations, please see the Flock® seating pages 92-101 and 104 for details. Reference Fabric Color Combinations on pages 20-24 for color codes and legend on page 21 for lead times.

 For Fire Code model, availability and ordering method, refer to pages 28-31. Available on select models, contact HON Customer Support for availability.

FLOCK® ROUND LOUNGE HFLRC1/DF HON BRANDED FABRICS

| GRADE 1 | GRADE 2 | GRADE 3 | GRADE L |
|--------------------------|-----------------|------------------|----------------|
| Centurion | Appoint Seating | In Season | Denver Leather |
| Compass | Clyde | Purl | |
| Contourette Polyurethane | Rush | Silvertex™ Vinyl | |
| Dapper | Seed* | | |
| Hamilton | Spin Seating | | |
| Inertia | Whisper Vinyl | | |
| Optic | | | |

For a complete list of fabrics, including partnership fabrics, go to hon.com/fabricsandfinishes.

Flock® chair model HFLRC1 has fabric limitations, please see the Flock® seating pages 92-101 for details.

*Available on seat only.

Reference Fabric Color Combinations on pages 20-24 for color codes and legend on page 21 for lead times.

 For Fire Code model, availability and ordering method, refer to pages 28-31. Available on select models, contact HON Customer Support for availability.



HFSS7

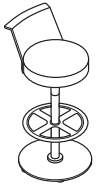

STOOL

DIMENSIONS

| | | | |
|--------------|-----|-----------------------|----------|
| Depth: | 18 | Seat to Floor Height: | 31 |
| Width: | 18 | Usable Seat Depth: | 15¾ |
| Height: | 39⅞ | Ship Weight: | 57 |
| Seat Depth: | 15¾ | Cube: | 11.0 |
| Seat Width: | 15¾ | COM: | 1.5 |
| Back Width: | 15¾ | Weight Rating: | 300 lbs. |
| Back Height: | 8 | | |

FABRIC PRICE CODES

| | | | |
|----------|--------------|-----------|---------------|
| 1 | \$756 | 8 | \$963 |
| 2 | \$792 | 9 | \$990 |
| 3 | \$828 | 10 | \$1017 |
| 4 | \$855 | 11 | \$1044 |
| 5 | \$882 | 12 | \$1071 |
| 6 | \$909 | L | \$1056 |
| 7 | \$936 | | |

HON Recommendation: HFSS7.PT.PNS__P6N - List Price \$792

HOW TO SPECIFY

Select Model Number

HFSS7

Select Shell Color

- LA Lava
- ON Onyx
- PT Platinum
- SD Shadow

PT

Select Fabric

See page 103

PNS007

Select Frame

- P6N Textured Satin Chrome
- P7A Textured Charcoal

P6N



Icon Legend on page 17

HFSG6



SIN 711-17

GUEST CHAIR

Casual

DIMENSIONS

| | | | |
|--------------|---------------------------------|-----------------------|--------------------------------|
| Depth: | 23 ⁵ / ₁₆ | Seat to Floor Height: | 18 ¹ / ₄ |
| Width: | 19 | Usable Seat Depth: | 16 ⁷ / ₈ |
| Height: | 32 ¹ / ₂ | Ship Weight: | 24 |
| Seat Depth: | 16 ⁷ / ₈ | Cube: | 10.4 |
| Seat Width: | 19 | COM: | 1.8 |
| Back Width: | 19 | Weight Rating: | 300 lbs. |
| Back Height: | 14 ¹ / ₄ | | |

FABRIC PRICE CODES

| | | | |
|---|-------|----|-------|
| 1 | \$566 | 8 | \$842 |
| 2 | \$614 | 9 | \$878 |
| 3 | \$662 | 10 | \$914 |
| 4 | \$698 | 11 | \$950 |
| 5 | \$734 | 12 | \$986 |
| 6 | \$770 | L | \$966 |
| 7 | \$806 | | |

HFCL1



SIN 711-17

LOUNGE CHAIR

Casual

DIMENSIONS

| | | | |
|--------------|---------------------------------|-----------------------|--------------------------------|
| Depth: | 25 | Seat to Floor Height: | 18 ¹ / ₄ |
| Width: | 22 | Usable Seat Depth: | 17 ¹ / ₂ |
| Height: | 32 ¹ / ₁₆ | Ship Weight: | 28 |
| Seat Depth: | 17 ¹ / ₂ | Cube: | 12.6 |
| Seat Width: | 22 | COM: | 2.0 |
| Back Width: | 22 | Weight Rating: | 300 lbs. |
| Back Height: | 14 ¹ / ₈ | | |

FABRIC PRICE CODES

| | | | |
|---|-------|----|--------|
| 1 | \$652 | 8 | \$928 |
| 2 | \$700 | 9 | \$964 |
| 3 | \$748 | 10 | \$1000 |
| 4 | \$784 | 11 | \$1036 |
| 5 | \$820 | 12 | \$1072 |
| 6 | \$856 | L | \$1052 |
| 7 | \$892 | | |

HFSS74L



SIN 711-18

STOOL

4-Leg

DIMENSIONS

| | | | |
|--------------|--------------------------------|-----------------------|--------------------------------|
| Depth: | 21 ¹ / ₈ | Seat to Floor Height: | 30 |
| Width: | 18 | Usable Seat Depth: | 15 ¹ / ₈ |
| Height: | 40 ⁷ / ₈ | Ship Weight: | 35 |
| Seat Depth: | 15 ¹ / ₈ | Cube: | 21.8 |
| Seat Width: | 18 | COM: | 1.9 |
| Back Width: | 18 | Weight Rating: | 300 lbs. |
| Back Height: | 10 ⁷ / ₈ | | |

FABRIC PRICE CODES

| | | | |
|---|-------|----|--------|
| 1 | \$706 | 8 | \$982 |
| 2 | \$754 | 9 | \$1018 |
| 3 | \$802 | 10 | \$1054 |
| 4 | \$838 | 11 | \$1090 |
| 5 | \$874 | 12 | \$1126 |
| 6 | \$910 | L | \$1106 |
| 7 | \$946 | | |

HON Recommendation: HFSS74L.PNS__P6N - List Price \$754

HOW TO SPECIFY

Select Model Number

HFSS74L

Select Fabric

See page 103

PNS007

Select Frame

P6N Textured Satin Chrome (only)

P6N



HF CG6DF



CASUAL GUEST CHAIR

Dual Fabric

DIMENSIONS

| | | | |
|--------------|---------------------------------|-----------------------|--------------------------------|
| Depth: | 23 ⁵ / ₁₆ | Seat to Floor Height: | 18 ¹ / ₄ |
| Width: | 19 | Usable Seat Depth: | 16 ⁷ / ₈ |
| Height: | 32 ¹ / ₂ | Ship Weight: | 24 |
| Seat Depth: | 16 ⁷ / ₈ | Cube: | 10.4 |
| Seat Width: | 19 | COM: | See page 108 |
| Back Width: | 19 | Weight Rating: | 300 lbs. |
| Back Height: | 14 ¹ / ₄ | | |

FABRIC PRICE CODES

1 \$641

Add to Base Price Above

| | Back | Seat |
|----|-------|-------|
| 2 | \$24 | \$24 |
| 3 | \$48 | \$48 |
| 4 | \$66 | \$66 |
| 5 | \$84 | \$84 |
| 6 | \$102 | \$102 |
| 7 | \$120 | \$120 |
| 8 | \$138 | \$138 |
| 9 | \$156 | \$156 |
| 10 | \$174 | \$174 |
| 11 | \$192 | \$192 |
| 12 | \$210 | \$210 |
| L | \$200 | \$200 |

HF CL1DF



CASUAL LOUNGE CHAIR

Dual Fabric

DIMENSIONS

| | | | |
|--------------|---------------------------------|-----------------------|--------------------------------|
| Depth: | 25 | Seat to Floor Height: | 18 ¹ / ₄ |
| Width: | 22 | Usable Seat Depth: | 17 ¹ / ₂ |
| Height: | 32 ¹ / ₁₆ | Ship Weight: | 28 |
| Seat Depth: | 17 ¹ / ₂ | Cube: | 12.6 |
| Seat Width: | 22 | COM: | See page 108 |
| Back Width: | 22 | Weight Rating: | 300 lbs. |
| Back Height: | 14 ¹ / ₈ | | |

FABRIC PRICE CODES

1 \$727

Add to Base Price Above

| | Back | Seat |
|----|-------|-------|
| 2 | \$24 | \$24 |
| 3 | \$48 | \$48 |
| 4 | \$66 | \$66 |
| 5 | \$84 | \$84 |
| 6 | \$102 | \$102 |
| 7 | \$120 | \$120 |
| 8 | \$138 | \$138 |
| 9 | \$156 | \$156 |
| 10 | \$174 | \$174 |
| 11 | \$192 | \$192 |
| 12 | \$210 | \$210 |
| L | \$200 | \$200 |

HF SS74LDF



4-LEG STOOL

Dual Fabric

DIMENSIONS

| | | | |
|--------------|--------------------------------|-----------------------|--------------------------------|
| Depth: | 21 ⁷ / ₈ | Seat to Floor Height: | 30 |
| Width: | 18 | Usable Seat Depth: | 15 ⁷ / ₈ |
| Height: | 40 ⁷ / ₈ | Ship Weight: | 35 |
| Seat Depth: | 15 ⁷ / ₈ | Cube: | 21.8 |
| Seat Width: | 18 | COM: | See page 108 |
| Back Width: | 18 | Weight Rating: | 300 lbs. |
| Back Height: | 10 ⁷ / ₈ | | |

FABRIC PRICE CODES

1 \$781

Add to Base Price Above

| | Back | Seat |
|----|-------|-------|
| 2 | \$24 | \$24 |
| 3 | \$48 | \$48 |
| 4 | \$66 | \$66 |
| 5 | \$84 | \$84 |
| 6 | \$102 | \$102 |
| 7 | \$120 | \$120 |
| 8 | \$138 | \$138 |
| 9 | \$156 | \$156 |
| 10 | \$174 | \$174 |
| 11 | \$192 | \$192 |
| 12 | \$210 | \$210 |
| L | \$200 | \$200 |

HON Recommendation: HFSS74LDF.PNS__PNS__P6N - List Price \$829

HOW TO SPECIFY

| | | | |
|--|--|--|---|
| <p>Select Model Number</p> <p>HFSS74LDF</p> | <p>Select Back Fabric</p> <p>See page 103</p> <p>PNS004</p> | <p>Select Seat Fabric</p> <p>See page 103</p> <p>PNS007</p> | <p>Select Frame</p> <p>P6N Textured Satin Chrome (only)</p> <p>P6N</p> |
|--|--|--|---|

MODEL OPTIONS

HFLCO1
HFLCO1DF - Dual Fabric

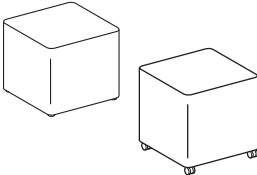

Mini Cube

HFLYO1
HFLYO1DF - Dual Fabric

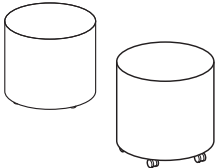

Mini Cylinder

HFLCO1T
HFLCO1TDF - Dual Fabric

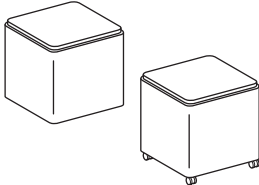

**Square Mini with Laminate
Topper**

HFLYO1T
HFLYO1TDF - Dual Fabric

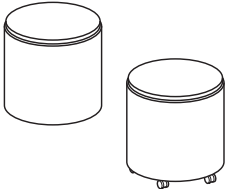

**Round Mini with Laminate
Topper**

FLOCK® Options

CASTER/ GLIDES

| CODE | DESCRIPTION | PRICE |
|-------------|----------------------------------|--------------|
| H | Hard Caster | +\$0 |
| HG | Hidden Glide | +\$0 |
| LP6N | Textured Satin Chrome Disc Glide | +\$45 |
| LP7A | Textured Charcoal Disc Glide | +\$45 |

DUAL FABRIC COM YARDAGE

Due to fabric pattern nesting and potential reduction of fabric yield, some dual fabric models may require more total yardage than standard models.

| | BACK | SEAT |
|-----------|---------|---------|
| HFLSC1DF | 3.5 yd | 1.5 yd |
| HFLMC1DF | 1.5 yd | 1.5 yd |
| HFLML1DF | 2.5 yd | 1.5 yd |
| HFLMR1DF | 2.5 yd | 1.5 yd |
| HFCG6DF | 1.75 yd | 2.0 yd |
| HFCL1DF | 1.75 yd | 2.0 yd |
| HFSS74LDF | 1.75 yd | 2.0 yd |
| HFLWI45DF | 1.5 yd | 1.5 yd |
| HFLWO45DF | 1.5 yd | 1.5 yd |
| HFLCC1DF | 2.5 yd | 1.5 yd |
| | TOP | SIDE |
| HFLCO1DF | .75 yd | 1.25 yd |
| HFLYO1DF | .75 yd | 1.25 yd |

HON BRANDED FABRICS

GRADE 1

Attire
Centurion
Compass
Contourette Polyurethane
Dapper
Hamilton
Inertia
Optic

GRADE 2

Appoint Seating
Clyde
Dotty
Rush
Seed*
Spin Seating
Whisper Vinyl

GRADE 3

In Season
Purl
Silvertex™ Vinyl

GRADE L

Denver Leather

For a complete list of fabrics, including partnership fabrics, go to hon.com/fabricsandfinishes.

Flock® chair model HFLRC1 has fabric limitations, please see the Flock® seating pages 92-101 for details.

*Available on seat only.

Reference Fabric Color Combinations on pages 20-24 for color codes and legend on page 21 for lead times.

 For Fire Code model, availability and ordering method, refer to pages 28-31. Available on select models, contact HON Customer Support for availability.



Mini Cube and Cylinders

HFLCO1

MINI CUBE

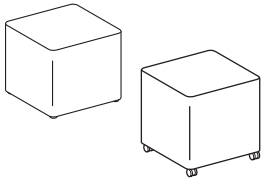

DIMENSIONS

| | | | |
|-------------|-----|-----------------------|-------------|
| Depth: | 18½ | Seat to Floor Height: | 17 |
| Width: | 18½ | Usable Seat Depth: | 18½ |
| Height: | 17 | Ship Weight: | 15 Ⓞ |
| Seat Depth: | 18½ | Cube: | 5.0 |
| Seat Width: | 18½ | COM: | 1.8 |
| | | Weight Rating: | 300 lbs. |

FABRIC PRICE CODES

| | | | |
|---|-------|----|-------|
| 1 | \$437 | 8 | \$644 |
| 2 | \$473 | 9 | \$671 |
| 3 | \$509 | 10 | \$698 |
| 4 | \$536 | 11 | \$725 |
| 5 | \$563 | 12 | \$752 |
| 6 | \$590 | L | \$737 |
| 7 | \$617 | | |

HFLYO1

MINI CYLINDER

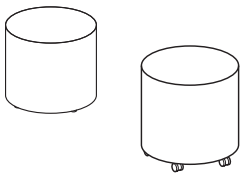

DIMENSIONS

| | | | |
|-------------|-----|-----------------------|-------------|
| Depth: | 18½ | Seat to Floor Height: | 17 |
| Width: | 18½ | Usable Seat Depth: | 18½ |
| Height: | 17 | Ship Weight: | 13 Ⓞ |
| Seat Depth: | 18½ | Cube: | 5.0 |
| Seat Width: | 18½ | COM: | 1.2 |
| | | Weight Rating: | 300 lbs. |

FABRIC PRICE CODES

| | | | |
|---|-------|----|-------|
| 1 | \$437 | 8 | \$644 |
| 2 | \$473 | 9 | \$671 |
| 3 | \$509 | 10 | \$698 |
| 4 | \$536 | 11 | \$725 |
| 5 | \$563 | 12 | \$752 |
| 6 | \$590 | L | \$737 |
| 7 | \$617 | | |

HFLCO1T

SQUARE MINI WITH LAMINATE TOPPER

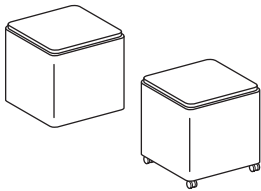

DIMENSIONS

| | | | |
|-------------|-----|-----------------------|----------|
| Depth: | 18½ | Seat to Floor Height: | 17¾ |
| Width: | 18½ | Usable Seat Depth: | 18½ |
| Height: | 17¾ | Ship Weight: | 24 |
| Seat Depth: | 18½ | Cube: | 5.4 |
| Seat Width: | 18½ | COM: | 1.8 |
| | | Weight Rating: | 300 lbs. |

FABRIC PRICE CODES

| | | | |
|---|-------|----|-------|
| 1 | \$554 | 8 | \$761 |
| 2 | \$590 | 9 | \$788 |
| 3 | \$626 | 10 | \$815 |
| 4 | \$653 | 11 | \$842 |
| 5 | \$680 | 12 | \$869 |
| 6 | \$707 | L | \$854 |
| 7 | \$734 | | |

HFLYO1T

ROUND MINI WITH LAMINATE TOPPER

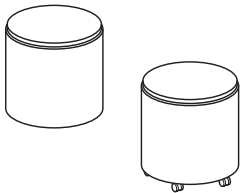

DIMENSIONS

| | | | |
|-------------|-----|-----------------------|----------|
| Depth: | 18½ | Seat to Floor Height: | 17¾ |
| Width: | 18½ | Usable Seat Depth: | 18½ |
| Height: | 17¾ | Ship Weight: | 24 |
| Seat Depth: | 18½ | Cube: | 5.4 |
| Seat Width: | 18½ | COM: | 1.8 |
| | | Weight Rating: | 300 lbs. |

FABRIC PRICE CODES

| | | | |
|---|-------|----|-------|
| 1 | \$554 | 8 | \$761 |
| 2 | \$590 | 9 | \$788 |
| 3 | \$626 | 10 | \$815 |
| 4 | \$653 | 11 | \$842 |
| 5 | \$680 | 12 | \$869 |
| 6 | \$707 | L | \$854 |
| 7 | \$734 | | |

HON Recommendation: HFLYO1.HG.PNS__ - List Price \$473

HOW TO SPECIFY

| | | | |
|--|---|---|---|
| <p>Select Model Number</p> <p>HFLYO1 .</p> <p>HFLYO1T .</p> | <p>Select Glide</p> <p>H Caster</p> <p>HG Hidden Glide</p> <p>LP6N Textured Satin Chrome Disc Glide (+ \$45)</p> <p>LP7A Textured Charcoal Disc Glide (+ \$45)</p> <p>HG .</p> <p>HG .</p> | <p>Select Fabric</p> <p>See page 108</p> <p>PNS007</p> <p>PNS007 .</p> | <p>Select Laminate and Edgeband Color</p> <p>See page 112</p> <p>L2 (+ \$10)</p> <p>NN</p> |
|--|---|---|---|



HFLCO1DF

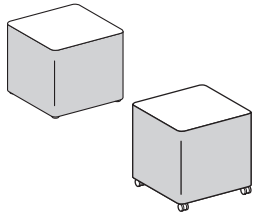

MINI CUBE

Dual Fabric

DIMENSIONS

| | | | |
|-------------|-----|-----------------------|--------------|
| Depth: | 18½ | Seat to Floor Height: | 17 |
| Width: | 18½ | Usable Seat Depth: | 18½ |
| Height: | 17 | Ship Weight: | 15 S |
| Seat Depth: | 18½ | Cube: | 5.0 |
| Seat Width: | 18½ | COM: | See page 108 |
| | | Weight Rating: | 300 lbs. |

FABRIC PRICE CODES

| | | |
|--------------------------------|--------------|--------------|
| 1 | \$512 | |
| <i>Add to Base Price Above</i> | | |
| | Top | Sides |
| 2 | \$11 | \$25 |
| 3 | \$22 | \$50 |
| 4 | \$30 | \$69 |
| 5 | \$38 | \$88 |
| 6 | \$46 | \$107 |
| 7 | \$54 | \$126 |
| 8 | \$62 | \$145 |
| 9 | \$70 | \$164 |
| 10 | \$78 | \$183 |
| 11 | \$86 | \$202 |
| 12 | \$95 | \$221 |
| L | \$90 | \$210 |

HFLYO1DF

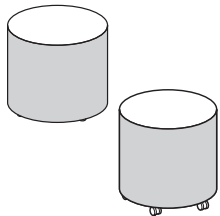

MINI CYLINDER

Dual Fabric

DIMENSIONS

| | | | |
|-------------|-----|-----------------------|--------------|
| Depth: | 18½ | Seat to Floor Height: | 17 |
| Width: | 18½ | Usable Seat Depth: | 18½ |
| Height: | 17 | Ship Weight: | 13 S |
| Seat Depth: | 18½ | Cube: | 5.0 |
| Seat Width: | 18½ | COM: | See page 108 |
| | | Weight Rating: | 300 lbs. |

FABRIC PRICE CODES

| | | |
|--------------------------------|--------------|--------------|
| 1 | \$512 | |
| <i>Add to Base Price Above</i> | | |
| | Top | Sides |
| 2 | \$11 | \$25 |
| 3 | \$22 | \$50 |
| 4 | \$30 | \$69 |
| 5 | \$38 | \$88 |
| 6 | \$46 | \$107 |
| 7 | \$54 | \$126 |
| 8 | \$62 | \$145 |
| 9 | \$70 | \$164 |
| 10 | \$78 | \$183 |
| 11 | \$86 | \$202 |
| 12 | \$95 | \$221 |
| L | \$90 | \$210 |

HON Recommendation: HFLCO1DF.HG.PNS___.PNS__ - List Price \$548

HOW TO SPECIFY

| | | | |
|--|--|--|---|
| <p>Select Model Number</p> <p>H F L C O 1 D F .</p> | <p>Select Glide</p> <p>H Caster HG Hidden Glide LP6N Textured Satin Chrome Disc Glide (+ \$45) LP7A Textured Charcoal Disc Glide (+ \$45)</p> <p>H G .</p> | <p>Select Top Fabric</p> <p>See page 108</p> <p>P N S 0 0 7 .</p> | <p>Select Side Fabric</p> <p>See page 108</p> <p>P N S 0 0 4 .</p> |
|--|--|--|---|



Dual Fabric Mini Cube and Cylinder

HFLCO1TDF

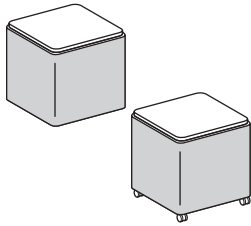

SQUARE MINI WITH LAMINATE TOPPER

Dual Fabric

DIMENSIONS

| | | | |
|-------------|-----|-----------------------|--------------|
| Depth: | 18½ | Seat to Floor Height: | 17¾ |
| Width: | 18½ | Usable Seat Depth: | 18½ |
| Height: | 17¾ | Ship Weight: | 24 |
| Seat Depth: | 18½ | Cube: | 5.4 |
| Seat Width: | 18½ | COM: | See page 108 |
| | | Weight Rating: | 300 lbs. |

FABRIC PRICE CODES

| | | |
|--------------------------------|--------------|--------------|
| 1 | \$629 | |
| <i>Add to Base Price Above</i> | | |
| | Top | Sides |
| 2 | \$11 | \$25 |
| 3 | \$22 | \$50 |
| 4 | \$30 | \$69 |
| 5 | \$38 | \$88 |
| 6 | \$46 | \$107 |
| 7 | \$54 | \$126 |
| 8 | \$62 | \$145 |
| 9 | \$70 | \$164 |
| 10 | \$78 | \$183 |
| 11 | \$86 | \$202 |
| 12 | \$95 | \$221 |
| L | \$90 | \$210 |

HFLYO1TDF

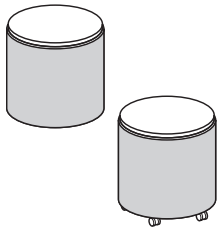

ROUND MINI WITH LAMINATE TOPPER

Dual Fabric

DIMENSIONS

| | | | |
|-------------|-----|-----------------------|--------------|
| Depth: | 18½ | Seat to Floor Height: | 17¾ |
| Width: | 18½ | Usable Seat Depth: | 18½ |
| Height: | 17¾ | Ship Weight: | 24 |
| Seat Depth: | 18½ | Cube: | 5.4 |
| Seat Width: | 18½ | COM: | See page 108 |
| | | Weight Rating: | 300 lbs. |

FABRIC PRICE CODES

| | | |
|--------------------------------|--------------|--------------|
| 1 | \$629 | |
| <i>Add to Base Price Above</i> | | |
| | Top | Sides |
| 2 | \$11 | \$25 |
| 3 | \$22 | \$50 |
| 4 | \$30 | \$69 |
| 5 | \$38 | \$88 |
| 6 | \$46 | \$107 |
| 7 | \$54 | \$126 |
| 8 | \$62 | \$145 |
| 9 | \$70 | \$164 |
| 10 | \$78 | \$183 |
| 11 | \$86 | \$202 |
| 12 | \$95 | \$221 |
| L | \$90 | \$210 |

HON Recommendation: HFLCO1TDF.HG.PNS__PNS__ - List Price \$665

HOW TO SPECIFY

| | | | | |
|-----------------------------------|---|---|--|--|
| <p>Select Model Number</p> | <p>Select Glide</p> <p>H Caster HG Hidden Glide LP6N Textured Satin Chrome Disc Glide (+ \$45) LP7A Textured Charcoal Disc Glide (+ \$45)</p> | <p>Select Top Fabric</p> <p>See page 108</p> | <p>Select Side Fabric</p> <p>See page 108</p> | <p>Select Laminate and Edgeband Color</p> <p>See page 112 L2 (+ \$10)</p> |
| <p>H F L C O 1 T D F .</p> | <p>H G .</p> | <p>P N S 0 0 7 .</p> | <p>P N S 0 0 4 .</p> | <p>N N</p> |

FLOCK® Table Options

COLLABORATIVE TABLES ORDERING INFORMATION

| | | | Table Tops | Table Bases | Tablets | Legs/Lamps |
|------------------|-------------------------|-------|------------|-------------|---------|------------|
| TOPS | L1 LAMINATES | CODES | | | | |
| Woodgrain | ◆ Bourbon Cherry | H | • | | • | |
| | ◆ Cognac | COGN | • | | • | |
| | ◆ Harvest | C | • | | • | |
| | ◆ Mahogany | N | • | | • | |
| | ◆ Mocha | MOCH | • | | • | |
| | ◆ Natural Maple | D | • | | • | |
| | ◆ Pinnacle | PINC | • | | • | |
| | ◆ Shaker Cherry | F | • | | • | |
| Solid | ◆ Black | P | • | | • | |
| | ◆ Brilliant White | WHIT | • | | • | |
| | ◆ Charcoal | S | • | | • | |
| | ◆ Loft | LOFT | • | | • | |
| | ◆ Whitestone | K4 | • | | • | |
| Patterned | ◆ Sheer Mesh | A5 | • | | • | |
| | ◆ Silver Mesh | B9 | • | | • | |
| | ◆ Steel Mesh | A9 | • | | • | |
| | ◆ Canyon Zephyr | K9 | • | | • | |
| | ◆ Desert Zephyr | K8 | • | | • | |
| | ◆ Shadow Zephyr | K1 | • | | • | |
| TOPS | L2 LAMINATES | CODES | | | | |
| Woodgrain | ◆ Lowell Ash | LLA1 | • | | • | |
| | ◆ Natural Recon | LNRI | • | | • | |
| | ◆ Phantom Ecu | LPE1 | • | | • | |
| | ◆ Portico Teak | LPT1 | • | | • | |
| | ◆ Skyline Walnut | LSW1 | • | | • | |
| EDGE BAND* | | CODES | | | | |
| | ◆ Black | P | • | | • | |
| | ◆ Bourbon Cherry | H | • | | • | |
| | ◆ Brilliant White | WHIT | • | | • | |
| | ◆ Charcoal | S | • | | • | |
| | ◆ Cognac | COGN | • | | • | |
| | ◆ Greige | R | • | | • | |
| | ◆ Harvest | C | • | | • | |
| | ◆ Loft | LOFT | • | | • | |
| | ◆ Lowell Ash | DL | • | | • | |
| | ◆ Mahogany | N | • | | • | |
| | ◆ Mocha | MOCH | • | | • | |
| | ◆ Muslin | T | • | | • | |
| | ◆ Natural Maple | D | • | | • | |
| | ◆ Natural Recon | NR | • | | • | |
| | ◆ Phantom Ecu | PE | • | | • | |
| | ◆ Pinnacle | PINC | • | | • | |
| | ◆ Platinum | K | • | | • | |
| | ◆ Portico Teak | DP | • | | • | |
| | ◆ Shadow | SHDW | • | | • | |
| | ◆ Shaker Cherry | F | • | | • | |
| ◆ Skyline Walnut | SW | • | | • | | |
| PAINTS** | | CODES | | | | |
| Textured | ◆ Textured Satin Chrome | P6N | • | | • | |
| | ◆ Textured Charcoal | P7A | • | | • | |

Recommended Edgeband Color Selection:

| LAMINATE | | EDGE BAND | |
|-----------------|------|-----------------|------|
| Bourbon Cherry | H | Bourbon Cherry | H |
| Cognac | COGN | Cognac | COGN |
| Harvest | C | Harvest | C |
| Mahogany | N | Mahogany | N |
| Mocha | MOCH | Mocha | MOCH |
| Natural Maple | D | Natural Maple | D |
| Pinnacle | PINC | Pinnacle | PINC |
| Shaker Cherry | F | Shaker Cherry | F |
| Black | P | Black | P |
| Brilliant White | WHIT | Brilliant White | WHIT |
| Charcoal | S | Charcoal | S |
| Whitestone | K4 | Muslin | T |
| Sheer Mesh | A5 | Muslin | T |
| Silver Mesh | B9 | Loft | LOFT |
| Steel Mesh | A9 | Charcoal | S |
| Canyon Zephyr | K9 | Greige | R |
| Desert Zephyr | K8 | Greige | R |
| Shadow Zephyr | K1 | Loft | LOFT |
| Lowell Ash | LLA1 | Lowell Ash | DL |
| Natural Recon | LNRI | Natural Recon | NR |
| Phantom Ecu | LPE1 | Phantom Ecu | PE |
| Portico Teak | LPT1 | Portico Teak | DP |
| Skyline Walnut | LSW1 | Skyline Walnut | SW |
| Loft | LOFT | Loft | LOFT |

* Edge detail color can be different from top color on laminate tops and tablets.

** Applies to all models — includes bases, legs, and lamps.

◆◆◆ For lead time information see page 21.

TOP SHAPES

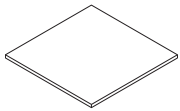

Square



Round

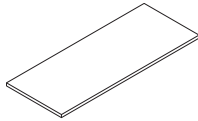

Rectangle



Racetrack

TABLE BASES

For 18" Tables

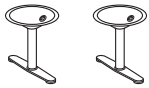

T-Leg Style

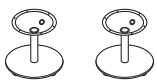

Disc Style

For 29½" Tables



X-Style



Disc Style

For 41" Standing Height Tables



X-Style

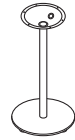

Disc Style

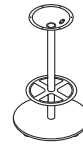

Disc Style
with Footring

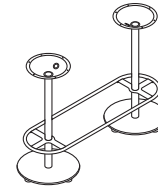

Disc Style
with Footring

TABLES



Personal
Table



Tablet
Accessory

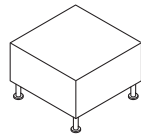

Cube
Table



Cylinder
Table

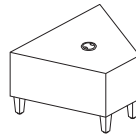

Wedge
Table

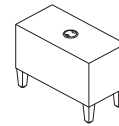

Rectangle
Table

ACCESSORIES



Lamp Accessory for
Cube/Cylinder Tables



Floor
Lamp



Lamp
Shade

FLOCK® Table Features

GROMMET MATRIX — ALL TABLES/TOPS

| TOP WIDTH | NO GROMMET | 1-3" ROUND GROMMET CENTERED | 2-3" ROUND GROMMET LEFT & RIGHT |
|-------------------------|------------|-----------------------------|---------------------------------|
| SIF OPTION CODE | N | G | G |
| 24" Cube | YES | YES | N/A |
| 26" Cylinder | YES | YES | N/A |
| 18" Personal | N/A | N/A | N/A |
| 30" Square/Round | YES | YES | N/A |
| 36" Square/Round | YES | YES | N/A |
| 60" Rectangle/Racetrack | YES | N/A | YES |
| 72" Rectangle/Racetrack | YES | N/A | YES |
| 84" Rectangle/Racetrack | YES | N/A | YES |
| 96" Rectangle/Racetrack | YES | N/A | YES |

3" ROUND GROMMET LOCATIONS

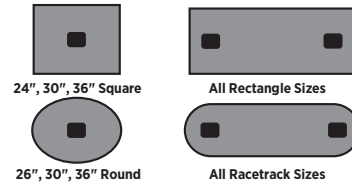

NOTES: 3" round grommet color will need to be specified for tops. Grommet will coordinate with paint color specified for cube/cylinder tables. Charcoal grommets will be used with Textured Charcoal paint and Platinum Metallic grommets will be used with Textured Satin Chrome paint.

Grommet options can be used in conjunction with accessory ports on cube/cylinder tables.

Grommet models HGRMTAC, HGRMTDATA and HGRMTUSB2 on page 122 can also be used with Flock® tables.

ACCESSORY PORT LOCATIONS

Only applies to models HFTLS24 and HFTLD26.

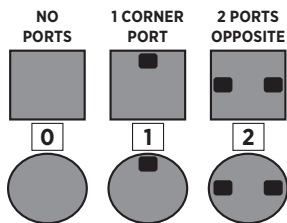

NOTES:

Port location 1 allows for either one tablet or one lamp accessory — see models on pages 120-121.

Port location 2 allows for either one tablet and one lamp accessory or two tablet accessories (two lamps cannot be used) — see models on pages 120-121.



FLOCK® Collaborative Laminate Table Tops

| | DESCRIPTION | MODEL | SHIP WEIGHT | CUBE | LIST PRICE BY LAMINATE GRADE | |
|--|----------------------------|------------------|-------------|------|------------------------------|--------------|
| | | | | | L1 | L2 |
| | Laminate Table Tops | | | | | |
| | 36" Square Top | HFTLS36 | 45 | 1.2 | \$404 | \$424 |
| | 30" Square Top | HFTLS30 | 32 | 1.0 | \$359 | \$379 |
| | 36" Round Top | HFTLD36 | 35 | 1.2 | \$404 | \$424 |
| | 30" Round Top | HFTLD30 | 25 | 1.0 | \$359 | \$379 |
| | 96"W x 33"D Rectangle Top | HFTLC3396 | 105 | 2.9 | \$716 | \$751 |
| | 84"W x 33"D Rectangle Top | HFTLC3384 | 90 | 2.5 | \$612 | \$642 |
| | 72"W x 33"D Rectangle Top | HFTLC3372 | 78 | 2.2 | \$512 | \$537 |
| | 60"W x 24"D Rectangle Top | HFTLC2460 | 47 | 1.3 | \$374 | \$389 |
| | 96"W x 33"D Racetrack Top | HFTLA3396 | 101 | 2.9 | \$716 | \$751 |
| | 84"W x 33"D Racetrack Top | HFTLA3384 | 83 | 2.5 | \$612 | \$642 |
| | 72"W x 33"D Racetrack Top | HFTLA3372 | 70 | 2.2 | \$512 | \$537 |
| | 60"W x 24"D Racetrack Top | HFTLA2460 | 43 | 1.3 | \$374 | \$389 |

NOTES: Choose from Square, Round, Rectangle or Racetrack shaped table tops. Grommet models HGRMTAC, HGRMTDATA and HGRMTUSB2 on page 122 can also be used with Flock® tables. Specify table tops with or without grommets. See page 114. Specify bases separately, see pages 116-117. Rectangle and Racetrack tops come with 2 grommet cutouts if specified with Round grommet. For a complete line of compatible Flock® collaborative seating solutions, please see pages 92-111 of the seating section.

HON Recommendation: HFTLS36.G.N.C - List Price \$404

HOW TO SPECIFY





| | | | |
|---|--|--|---|
| <p>Select Model Number</p> | <p>Select Edge Detail</p> <p>G 2MM Edge</p> | <p>Select Grommet Option</p> <p>N No Grommet G Round Grommet (+ \$15 per grommet cutout) See page 114 for Grommet placement</p> | <p>Select Laminate Color</p> <p>See page 112</p> |
| <p>Select Edge Color</p> <p>See page 112</p> | <p>Select Grommet Color</p> <p>S Charcoal T1 Platinum Metallic</p> | | |
| <p>H F T L S 3 6 .</p> | <p>G .</p> | <p>N .</p> | <p>C</p> |

FLOCK® Collaborative Table Bases

GSA SIN 711-11

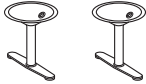
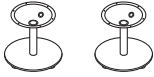

Icon Legend on page 17

| | DESCRIPTION | MODEL | SHIP WEIGHT | CUBE | LIST PRICE |
|--|--|---|----------------|----------------------|---|
|  | Base T-Leg Style — For 18”H Tables For 60”W x 24”D Rectangle or Racetrack Table Tops • Two bases shipped in separate cartons. | HFTB17N | 40 | 6.0 | \$900 |
|  | Base Disc Style — For 18”H Tables • Use with 60”W x 24”D Racetrack or Rectangle table tops only. • Two bases shipped in separate cartons. | HFDB17N | 74 | 6.0 | \$988 |
| | Base Disc Style — For 18”H Tables For 30” and 36” Round or Square Table Tops | HFDB17B | 37 | 3.0 | \$484 |
|  | Base X-Style — For 29½”H Tables For 30” Round or Square Table Tops For 36” Round or Square Table Tops Use with 33”D x 72”W x 84”W and 96”W Rectangle or Racetrack Table Tops • Two bases shipped in separate cartons | HFXB29A HFXB29B HFXB29AN | 40 53 80 | 16.1 16.1 32.2 | \$563 \$596 \$1126 |
|  | Base X-Style — For 18”H Tables For 30” and 36” Round or Square Table Tops | HFXB17B | 37 | 3.0 | \$484 |
|  | Base Disc Style — For 29½”H Tables For 30” Round or Square Table Tops For 36” Round or Square Table Tops Use with 33”D x 72”W x 84”W and 96”W Rectangle or Racetrack Table Tops • Two bases shipped in separate cartons | HFDB29A HFDB29B HFDB29AN | 40 56 80 | 16.1 16.1 32.2 | \$563 \$596 \$1126 |

NOTES: Flock® Bases available in Disc, T-Leg and X styles. Specify bases for collaborative tables at 18”H, 29½”H or 41”H standing height. Choose from bases with or without footrings. Each base includes adjustable leveling glides. Leveling glides adjust approximately 1”.

HON Recommendation: HFXB29AN.P7A - List Price \$1126

HOW TO SPECIFY

| | |
|-----------------------------------|--|
| <p>Select Model Number</p> | <p>Select Paint Color</p> <p>P6N Textured Satin Chrome P7A Textured Charcoal</p> |
| <p>H F X B 2 9 A N .</p> | <p>P 7 A</p> |

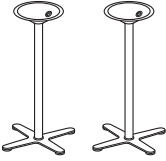
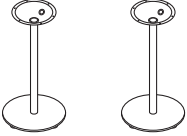
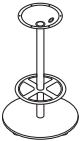

FLOCK® Collaborative Table Bases

| | DESCRIPTION | MODEL | SHIP WEIGHT | CUBE | LIST PRICE |
|---|--|---|-------------------|----------------------|---|
|  | Base X-Style — For 41”H Standing Height Tables <ul style="list-style-type: none"> Use with 33”D x 72”W, 84”W and 96”W Rectangle or Racetrack Table Tops Two bases shipped in separate cartons | HFXB42AN | 84 | 36.4 | \$1182 |
| | Base X-Style — For 41”H Standing Height Tables For 30” Round or Square Table Tops For 36” Round or Square Table Tops | HFXB42A HFXB42B | 42 55 | 18.2 16.1 | \$591 \$624 |
|  | Base Disc Style — For 41”H Standing Height Tables <ul style="list-style-type: none"> Use with 33”D x 72”W, 84”W and 96”W Rectangle or Racetrack table tops, when a Footring is not desired. Two bases shipped in separate cartons. | HFDB42AN | 92 | 19.0 | \$1146 |
| | Base Disc Style — For 41”H Standing Height Tables For 30” Round or Square Table Tops For 36” Round or Square Table Tops | HFDB42A HFDB42B | 46 62 | 9.5 13.5 | \$573 \$608 |
|  | Base Disc Style with Footring — For 41”H Standing Height Tables For 30” Round or Square Table Tops For 36” Round or Square Table Tops | HFDB42AF HFDB42BF | 56 68 | 9.5 13.5 | \$743 \$779 |
| | Use with 33”D x 72”W x 84”W and 96”W Rectangle or Racetrack Table Tops <ul style="list-style-type: none"> Two bases shipped in separate cartons | HFDB42AFN | 112 | 32.2 | \$1486 |
| | Base Disc Style with Footring — For 41”H Standing Height Tables For 33”D x 96”W Rectangle or Racetrack Table Tops For 33”D x 84”W Rectangle or Racetrack Table Tops For 33”D x 72”W Rectangle or Racetrack Table Tops | HFDB42AF96 HFDB42AF84 HFDB42AF72 | 121 123 125 | 19.7 19.8 19.9 | \$1717 \$1661 \$1632 |
| | NOTES: Includes two bases and a single oval footring that spans both tables. Two bases and footring shipped in three separate cartons. | | | | |
| | NOTES: Flock® Bases available in Disc, T-Leg and X styles. Specify bases for collaborative tables at 18”H, 29½”H or 41”H standing height. Choose from bases with or without footrings. Each base includes adjustable leveling glides. Leveling glides adjust approximately 1”. | | | | |

HON Recommendation: HFXB42B.P7A - List Price \$624

HOW TO SPECIFY

Select Model Number

H F X B 4 2 B .

Select Paint Color

P6N Textured Satin Chrome
P7A Textured Charcoal

P 7 A

FLOCK® Collaborative Tables

GSA SIN 711-11



Icon Legend on page 17



| DESCRIPTION | MODEL | SHIP WEIGHT | CUBE | L1 LIST | L2 UPCHARGE |
|---|-----------------|-------------|------|--------------|-------------|
| Laminate Personal Table 18" Dia. x 25"H NOTES: Accessory Port options on the Collaborative Cube and Cylinder tables allow for different accessories to be added to the tables such as tablet arms or lamps. Use the Tablet Accessory with the Collaborative Cube and Cylinder tables for additional workspace. Attaches to tables through ports, which can be located in different location options. See page 114 for port location information. For grommet and port information, see page 114. HGRMTAC, HGRMTDATA and HGRMTUSB2 on page 122 can also be used with Flock® tables. Legs can be adjusted for leveling. Standard Leg (L) can be adjusted for leveling. For a complete line of compatible Flock® collaborative seating solutions, please see pages 92-111 of the seating section. | HFTPTL18 | 36 | 4.5 | \$585 | \$12 |

HON Recommendation: HFTPTL18.C.C.P7A - List Price \$585

HOW TO SPECIFY

| | | | |
|---|--|---|---|
| Select Model Number H F T P T L 1 8 . | Select Edge Detail/Color C . | Select Laminate Top Color See page 112 C . | Select Base Paint Color P6N Textured Satin Chrome P7A Textured Charcoal P 7 A |
|---|--|---|---|



FLOCK® Collaborative Tables

| | DESCRIPTION | MODEL | SHIP WEIGHT | CUBE | L1 LIST | L2 UPCHARGE |
|---------------------------------|--|----------------------------------|-------------|------------|------------------------------|----------------------------|
| | Laminate Collaborative Cube and Cylinder Tables 24" Laminate Cube Table — 24"W x 24"D x 17½"H 26" Laminate Cylinder Table — 26" Dia. x 17½"H | HFTLS24 HFTLD26 | 44 39 | 5.0 5.0 | \$702 \$644 | \$30 \$30 |
| | NOTES: Accessory port quantity and configuration on tables should correspond to the accessories planned for the table. For grommet and port information, see page 114. | | | | | |
| | Laminate Wedge Table 22.17"W x 29.43"D x 17"H | HFTLW45 | 34 | 7.7 | \$671 | \$30 |
| <i>Shown with Round Grommet</i> | | | | | | |
| | Laminate Rectangle Table 24"W x 12"D x 17"H | HFTLR12 | 29 | 3.9 | \$467 | \$20 |
| <i>Shown with Round Grommet</i> | | | | | | |

HON Recommendation: HFTLS24.N.O.N.TS.P7A - List Price \$702

HOW TO SPECIFY

| | | | | | |
|---|---|---|---|--|---|
| Select Model Number H F T L S 2 4 . | Select Grommet Option See page 114 for Grommet placement N No Grommet G Round Grommet — centered (+ \$15) | Select Accessory Port Option See page 114 for Port placement 0 No Port 1 One Corner Port 2 Two Ports — Opposite (+ \$10 per port) | Select Laminate Top Color See page 112 N . | Select Leg Option L Standard Leg Leg Options TR Tapered Round Leg TS Tapered Square Leg | Select Paint Color P6N Textured Satin Chrome P7A Textured Charcoal |
|---|---|---|---|--|---|

FLOCK® Collaborative Tables

GSA SIN 711-11



Icon Legend on page 17



| DESCRIPTION | MODEL | SHIP WEIGHT | CUBE | L1 LIST | L2 UPCHARGE |
|--|-----------------|-------------|------|--------------|-------------|
| Laminate Tablet Accessory 14" Dia. x 10"H from table top Use with Collaborative Cube and Cylinder tables for additional workspace. Attaches to tables through ports. Multiple port location options are available. Tablet pivots/swivels toward the user. | HFTTAL14 | 6 | 2.5 | \$348 | \$15 |

HON Recommendation: HFTTAL14.C.C.P7A - List Price \$348

HOW TO SPECIFY

| | | | |
|---|--|---|--|
| Select Model Number H F T T A L 1 4 . | Select Edge Detail/Color C . | Select Laminate Top Color See page 112 C . | Select Paint Color P6N Textured Satin Chrome P7A Textured Charcoal P 7 A |
|---|--|---|--|



FLOCK® Collaborative Accessories



DESCRIPTION

Flock Floor Lamp
Flock Lamp Accessory for Cube/Cylinder Table

MODEL

HFAFL1
HFALA1

SHIP WEIGHT

35
 11

CUBE

0.04
 0.8

LIST PRICE

\$521
\$285

NOTES: Flock® Floor Lamp Accessory fits into the Cube or Cylinder table via a port, to add a lamp option to the table. Accessory port quantity and configuration on tables should correspond to the accessories planned for the table. For grommet and port information, see page 114. Both models use the Lamp Shade model HFASH1 below or accept shades that use the Nord style connector. Flock® Floor Lamp model HFAFL1 paired with Lamp Shade model HFASH1 to complete the Flock® collaborative space. Use the Lamp Accessory model HFALA1 with lamp shade model HFASH1 to add a coordinated lamp to any Cube or Cylinder table. Electrical components are ETL listed. For a complete line of compatible Flock® collaborative seating solutions, please see pages 92-111 of the seating section.

HOW TO SPECIFY

| | |
|-----------------------------------|--|
| <p>Select Model Number</p> | <p>Select Paint Color</p> <p>P6N Textured Satin Chrome P7A Textured Charcoal</p> |
| <p>H F A F L 1 .</p> | <p>P 7 A</p> |

| | DESCRIPTION | MODEL | SHIP WEIGHT | CUBE | LIST PRICE |
|---|---|---------------|--------------------|-------------|-------------------|
|  | <p>Flock Lamp Shade</p> <ul style="list-style-type: none"> • Drum-style (straight sides) • Fine linen fabric, with matching trim • Diffusers on top and bottom to provide even lighting | HFASH1 | 4 | 3.3 | \$317 |

HON Recommendation: HFAFL1.P7A - List Price \$521 + HFASH1.WL - List Price \$317 = Total Price \$838

HOW TO SPECIFY

| | |
|-----------------------------------|---|
| <p>Select Model Number</p> | <p>Select Color</p> <p>WL White Linen</p> |
| <p>H F A S H 1 .</p> | <p>W L</p> |



HGRMTAC

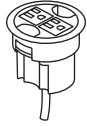

SIN 71-302

POWER HUB

3" Grommet Mount

DIMENSIONS

Ship Weight: 1.3
Cube: 0.2

LIST PRICE

\$106

NOTES: Fits in 3" round grommet holes. Field installed with Plug-and-play ease. Two grounded AC power outlets. Includes 6' cord with three-prong plug.

ⓘ Available in black only (no color designation so use .X)

HGRMTAC2

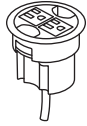

SIN 71-302

3' ROUND POWER GROMMET

2 Outlets, 10' Cord

DIMENSIONS

Ship Weight: 1.5
Cube: 0.2

LIST PRICE

\$133

NOTES: Power Modules will also work with standing-height applications for 10500 Series™ and Voi® desks. Optional Memory Control allows preset worksurface heights for consistency. Ships separately. Dynamic load capacity when worksurface is moving is 300 lbs. Includes 10' cord with three-prong plug. Fits in 3" round grommet holes on the following product lines: Coordinate™, Huddle, Motivate®, all laminate and veneer casegoods series, and Systems Worksurfaces. Two grounded AC power outlets. Field installed with Plug-and-play ease.

ⓘ Available in black finish only, no specification needed.

HGRMTUSB2



SIN 71-302

POWER/USB HUB

3" Grommet Mount

DIMENSIONS

Ship Weight: 1.3 ⓘ
Cube: 0.2

LIST PRICE

\$209

NOTES: One grounded AC power outlet with 2 USB ports. UL Listed.

ⓘ Available in black only (no color designation so use .X)

HGRMTDATA



SIN 711-11

DATA GROMMET

DIMENSIONS

Ship Weight: 0.2
Cube: 0.2

LIST PRICE

\$17

NOTES: Blank grommet kit that includes adapters for a variety of manufacturers jacks and couplers. Fits in existing 3" round grommet housing.

ⓘ Available in black only (no color designation so use .P)

HPWRMOD3UWM

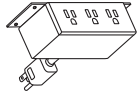

SIN 711-2

POWER MODULE

3 Receptacles with Under-Worksurface Mounting Bracket

DIMENSIONS

Ship Weight: 2.3 ⓘ
Cube: 0.2

LIST PRICE

\$287

NOTES: 6' power cord with standard three-prong plug. Under-worksurface mounting bracket models work with any top that has a 5" x 5" square clearance. Worksurface clamp models work on any top with a 4" overhang. UL Listed.

ⓘ Color finish coordinates with HON's Charcoal or White. Specify S for Charcoal or WHIT for White when ordering.

Example: HPWRMOD3UWM.S.

HPWRMOD2UWM

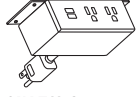

SIN 711-2

POWER MODULE

2 Receptacles 2 USB with Under-Worksurface Mounting Bracket

DIMENSIONS

Ship Weight: 2.3 ⓘ
Cube: 0.2

LIST PRICE

\$460

NOTES: 6' power cord with standard three-prong plug. Under-worksurface mounting bracket models work with any top that has a 5" x 5" square clearance. Worksurface clamp models work on any top with a 4" overhang. UL Listed.

ⓘ Color finish coordinates with HON's Charcoal or White. Specify S for Charcoal or WHIT for White when ordering.

Example: HPWRMOD2UWM.S.

HON Recommendation: HGRMTUSB2.X - List Price \$209

HOW TO SPECIFY

Select Model Number

HGRMTAC

GAMUT® 2070 SERIES



Gamut High-Back Chair shown
with 10500 Series™ desks.

GAMUT® 2070 SERIES

When you can fill every space with a consistent seating solution that unifies your organization, you've covered the Gamut. This collection of executive and conference seating features generous proportions, straightforward style and intuitive design elements. High-back and mid-back task chairs feature tilt tension, tilt lock and pneumatic seat height adjustment for a personal fit. Matching guest chairs create aesthetic consistency throughout your space, and provide outstanding comfort to your guests.



FEATURES

- Fixed arms increase upper body support.
- Fully-upholstered outer back.
- One-touch seat height adjustment easily moves the seat up and down.
- Tilt tension controls the rate and ease of recline.
- Tilt lock allows the user to lock out the tilt function.
- 360-degree swivel provides freedom of movement in any direction.
- Matching guest chair creates a coordinated workspace.
- Warranted for users up to 275 lbs.

GAMUT® 2070 Series Options

MODEL OPTIONS

H2071



Executive High-Back

Pneumatic, Swivel, Tilt, Tilt Tension, Tilt Lock, Loop Arms

H2072



Managerial Mid-Back

Pneumatic, Swivel, Tilt, Tilt Tension, Tilt Lock, Loop Arms

H2073



Guest Chair

Sled Base with Fixed Arms

CASTERS



| CODE | DESCRIPTION | PRICE |
|----------|-------------|-------------|
| H | Hard Caster | +\$0 |



| | | |
|----------|-------------|--------------|
| S | Soft Caster | +\$30 |
|----------|-------------|--------------|

*Only available on models H2071 and H2072

FRAME

| CODE | DESCRIPTION | PRICE |
|----------|-------------|-------------|
| T | Black | +\$0 |

HON BRANDED FABRICS

GRADE 1

Centurion
Compass
Contourette Polyurethane
Dapper
Hamilton
Inertia
Optic

GRADE 2

Appoint Seating
Clyde
Dotty
Rush
Seed
Spin Seating
Whisper Vinyl

GRADE 3

Purl
Silvertex™ Vinyl

For a complete list of fabrics, including partnership fabrics, go to hon.com/fabricsandfinishes.

Reference Fabric Color Combinations on pages 20-24 for color codes and legend on page 21 for lead times. COM yardage shown is for Pattern Cut only. Contact Customer Service for Railroaded yardage requirements. For additional HON to Supply COM fabric grade pricing, go to honready.hon.com and click on the HON to Supply COM link.

For Fire Code model, availability and ordering method, refer to pages 28-31. Available on select models, contact HON Customer Support for availability.



H2071



EXECUTIVE HIGH-BACK

Pneumatic
Swivel
Tilt
Tilt Tension
Tilt Lock
Loop Arms

Functions: **A, E, F, K, L**
(Function Key on pages 18-19)

DIMENSIONS

| | | | |
|--------------|-----|-----------------------|----------|
| Depth: | 36¼ | Arm Width: | 20¾ |
| Width: | 27½ | Seat to Floor Height: | 18½-23½ |
| Height: | 46⅝ | Usable Seat Depth: | 16⅝ |
| Seat Depth: | 16⅝ | Ship Weight: | 44 |
| Seat Width: | 20¼ | Cube: | 11.3 |
| Back Width: | 20¾ | COM: | 2.5 |
| Back Height: | 28 | Weight Rating: | 250 lbs. |

FABRIC PRICE CODES

| | | | |
|---|-------|----|--------|
| 1 | \$558 | 8 | \$903 |
| 2 | \$618 | 9 | \$948 |
| 3 | \$678 | 10 | \$993 |
| 4 | \$723 | 11 | \$1038 |
| 5 | \$768 | 12 | \$1083 |
| 6 | \$813 | L | — |
| 7 | \$858 | | |

H2072



MANAGERIAL MID-BACK

Pneumatic
Swivel
Tilt
Tilt Tension
Tilt Lock
Loop Arms

Functions: **A, E, F, K, L**
(Function Key on pages 18-19)

DIMENSIONS

| | | | |
|--------------|-----|-----------------------|----------|
| Depth: | 36¼ | Arm Width: | 20¾ |
| Width: | 27½ | Seat to Floor Height: | 18½-23½ |
| Height: | 43⅝ | Usable Seat Depth: | 16⅝ |
| Seat Depth: | 16⅝ | Ship Weight: | 43 |
| Seat Width: | 20¼ | Cube: | 10.3 |
| Back Width: | 20¾ | COM: | 2.5 |
| Back Height: | 25¼ | Weight Rating: | 250 lbs. |

FABRIC PRICE CODES

| | | | |
|---|-------|----|--------|
| 1 | \$531 | 8 | \$876 |
| 2 | \$591 | 9 | \$921 |
| 3 | \$651 | 10 | \$966 |
| 4 | \$696 | 11 | \$1011 |
| 5 | \$741 | 12 | \$1056 |
| 6 | \$786 | L | — |
| 7 | \$831 | | |

H2073



GUEST CHAIR

Sled Base with Fixed Arms

DIMENSIONS

| | | | |
|--------------|-----|-----------------------|----------|
| Depth: | 28¼ | Arm Width: | 20⅝ |
| Width: | 27 | Seat to Floor Height: | 19½ |
| Height: | 35⅝ | Usable Seat Depth: | 18 |
| Seat Depth: | 19 | Ship Weight: | 41 |
| Seat Width: | 20½ | Cube: | 19.8 |
| Back Width: | 20¼ | COM: | 2.0 |
| Back Height: | 17¾ | Weight Rating: | 250 lbs. |

FABRIC PRICE CODES

| | | | |
|---|-------|----|-------|
| 1 | \$421 | 8 | \$697 |
| 2 | \$469 | 9 | \$733 |
| 3 | \$517 | 10 | \$769 |
| 4 | \$553 | 11 | \$805 |
| 5 | \$589 | 12 | \$841 |
| 6 | \$625 | L | — |
| 7 | \$661 | | |

HON Recommendation: H2071.H.CU__T - List Price \$558

HOW TO SPECIFY

Select
Model Number

H 2 0 7 1 .

Select
Caster

H Hard Caster
S Soft Caster (+ \$30)
Does not apply to model H2073

H .

Select
Fabric

See page 124

C U 1 0 .

Select
Frame

T Black

T

GREET™ Modular Lounge

OPEN MARKET



Icon Legend on page 17

HVL892

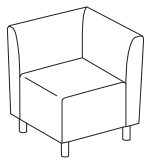

CORNER CHAIR

Non-handed
Single Arm

DIMENSIONS

| | | | |
|-------------|----|-----------------------|----------|
| Depth: | 25 | Back Height: | 12½ |
| Width: | 25 | Seat to Floor Height: | 17½ |
| Height: | 29 | Usable Seat Depth: | 20 |
| Seat Depth: | 20 | Ship Weight: | 46.3 |
| Seat Width: | 20 | Cube: | 10.2 |
| Back Width: | 20 | Weight Rating: | 250 lbs. |

LIST PRICE

\$505

NOTES: Thick cushioning and individually pocketed coil springs provide long-lasting comfort. Lightweight frame. Easier assembly — no tools required. Charcoal upholstery or Black SofThread™ Leather. **HON 5-Year Limited Warranty.**

HVL893

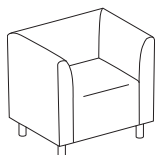

CLUB CHAIR

Two Arms

DIMENSIONS

| | | | |
|--------------|-----|-----------------------|----------|
| Depth: | 25 | Arm Width: | 25½ |
| Width: | 32¼ | Seat to Floor Height: | 17½ |
| Height: | 29 | Usable Seat Depth: | 20 |
| Seat Depth: | 20 | Ship Weight: | 57.3 |
| Seat Width: | 22½ | Cube: | 13.0 |
| Back Width: | 22½ | Weight Rating: | 250 lbs. |
| Back Height: | 12½ | | |

LIST PRICE

\$531

NOTES: Thick cushioning and individually pocketed coil springs provide long-lasting comfort. Lightweight frame. Easier assembly — no tools required. Charcoal upholstery or Black SofThread™ Leather. **HON 5-Year Limited Warranty.**

HVL894

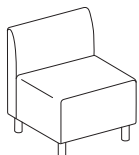

ARMLESS LOUNGE

Without Power

DIMENSIONS

| | | | |
|-------------|----|-----------------------|----------|
| Depth: | 25 | Back Height: | 12½ |
| Width: | 25 | Seat to Floor Height: | 17½ |
| Height: | 29 | Usable Seat Depth: | 20 |
| Seat Depth: | 20 | Ship Weight: | 30.9 |
| Seat Width: | 25 | Cube: | 10.2 |
| Back Width: | 25 | Weight Rating: | 250 lbs. |

LIST PRICE

\$430

NOTES: Thick cushioning and individually pocketed coil springs provide long-lasting comfort. Lightweight frame. Easier assembly — no tools required. Charcoal upholstery or Black SofThread™ Leather. **HON 5-Year Limited Warranty.**

HVL895

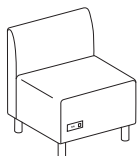

ARMLESS LOUNGE

With Power
1 AC Power Outlet
2 USB Power Outlets

DIMENSIONS

| | | | |
|-------------|----|-----------------------|----------|
| Depth: | 25 | Back Height: | 12½ |
| Width: | 25 | Seat to Floor Height: | 17½ |
| Height: | 29 | Usable Seat Depth: | 20 |
| Seat Depth: | 20 | Ship Weight: | 30.9 |
| Seat Width: | 25 | Cube: | 10.2 |
| Back Width: | 25 | Weight Rating: | 250 lbs. |

LIST PRICE

\$455

NOTES: Thick cushioning and individually pocketed coil springs provide long-lasting comfort. Lightweight frame. Easier assembly — no tools required. Charcoal upholstery or Black SofThread™ Leather. Power port. **HON 5-Year Limited Warranty.**

HOW TO SPECIFY

Select
Model Number

Select
Fabric

ES19 Charcoal Fabric
SB11 Black SofThread™ Leather (+ \$40)

H V L 8 9 2 .

E S 1 9



Icon Legend on page 17

HVL891

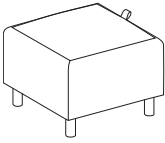

STORAGE OTTOMAN

Fabric/Laminate Reversible Top
Storage Compartment

DIMENSIONS

Depth: 25
Width: 25
Height: 17½

Seat to Floor Height: 17½
Ship Weight: 43 **Ⓢ**
Cube: 5.7
Weight Rating: 250 lbs.

LIST PRICE

\$329

NOTES: Thick cushioning. Lightweight frame. Easier assembly — no tools required. Storage space. Fabric/laminate reversible top. Charcoal upholstery or Black SofThread™ Leather. Black laminate. **HON 5-Year Limited Warranty.**

HOW TO SPECIFY

Select Model Number

H V L 8 9 1 .

Select Fabric

ES19 Charcoal Fabric
SB11 Black SofThread™ Leather (+ \$40)

E S 1 9 .

Select Laminate

P Black

P



Grove Lounge shown with Flock® Guest Chairs and Arrange® Tables.

GROVE®

Find a comfy place to put your feet up, huddle up and power up. Grove is the versatile lounge seating designed to help you greet, meet, focus, relax and accomplish more. This change-of-pace collection delivers the comfort people crave, while encouraging focus and interaction throughout the workplace. Grove's attractive design is rivaled only by its flexibility. Models include a single seat, two-seat, three-seat, and two-seat with table — all with three arm style and two leg style options, as well as accessories that support connectivity and collaboration. Grove has the look you're going for, and the comfort and versatility people have been waiting for.



FEATURES

- Each model can be combined to create arrangements suitable for any space.
- Optional integrated worksurfaces create more personal space and provide a convenient workspace.
- Design complements Flock ottomans and tables.
- Integrated power grommets keep laptops and phone powered up anywhere.
- The dual fabric option coordinates two high-quality HON fabrics for a contemporary look.
- Choose from Single Seat, Two-Seat, Three-Seat Lounge, or Two-Seat with Table options.
- Choose from 3 arm options — Armless (N), Straight Arms (A), or Tapered Arm (B).
- Table available with two grommets and an accessory port option.
- Offers a table between the seats that provides separation and a usable workspace.
- Warranted for users up to 300 lbs.

MODEL OPTIONS

HML1S
HML1SDF - Dual Fabric

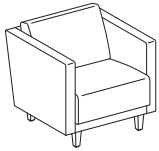

Lounge
Single Seat

HML2S
HML2SDF - Dual Fabric

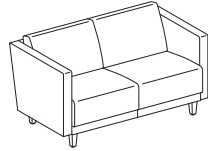

Lounge
Two-Seat

HML3S
HML3SDF - Dual Fabric

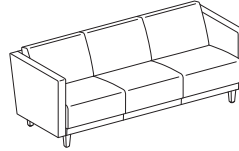

Lounge
Three-Seat

HML2ST
HML2STDF - Dual Fabric

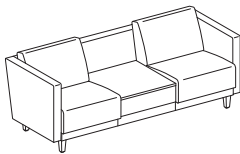

Lounge
Two-Seat with Table

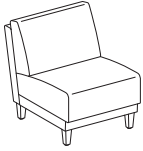
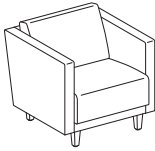
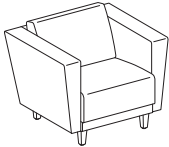

GROVE® Options

| ARM STYLE | CODE | DESCRIPTION | PRICE |
|--|----------|---------------|---------------|
|  | N | Armless | +\$0 |
|  | A | Straight Arms | +\$300 |
|  | B | Tapered Arms | +\$350 |

| L1 LAMINATE | COLOR CODE |
|-----------------|-------------|
| Black | P |
| Bourbon Cherry | H |
| Brilliant White | WHIT |
| Charcoal | S |
| Cognac | COGN |
| Harvest | C |
| Loft | LOFT |
| Mahogany | N |
| Mocha | MOCH |
| Natural Maple | D |
| Pinnacle | PINC |
| Shaker Cherry | F |

| L2 LAMINATE | COLOR CODE |
|----------------|-------------|
| Lowell Ash | LLA1 |
| Natural Recon | LNRI |
| Phantom Ecrú | LPE1 |
| Portico Teak | LPT1 |
| Skyline Walnut | LSW1 |

*Specify for models HML2ST and HML2STDF only

| LEG STYLE | CODE | DESCRIPTION | PRICE |
|---|-----------|----------------|-------------|
|  | TS | Tapered Square | +\$0 |
|  | TR | Tapered Round | +\$0 |

| LEG COLOR | CODE | DESCRIPTION | PRICE |
|-------------|------|-----------------------|---------------|
| P6N | | Textured Satin Chrome | +\$0 |
| P7A | | Textured Charcoal | +\$0 |
| H | | Bourbon Cherry | +\$100 |
| F | | Shaker Cherry | +\$100 |
| N | | Mahogany | +\$100 |
| C | | Harvest | +\$100 |
| D | | Natural Maple | +\$100 |
| MOCH | | Mocha | +\$100 |
| PINC | | Pinnacle | +\$100 |
| COGN | | Cognac | +\$100 |
| LLA1 | | Lowell Ash | +\$100 |
| LNRI | | Natural Recon | +\$100 |
| LPE1 | | Phantom Ecrú | +\$100 |
| LPT1 | | Portico Teak | +\$100 |
| LSW1 | | Skyline Walnut | +\$100 |

| CUT OUT | CODE | DESCRIPTION | PRICE |
|-----------|------|----------------------|--------------|
| N | | No Cutout | +\$0 |
| G | | Round Grommet Cutout | +\$30 |
| G1 | | Pop-Up Port Cutout | +\$40 |

*Specify for models HML2ST and HML2STDF only

ACCESSORY PORT LOCATION

| CODE | DESCRIPTION | PRICE |
|----------|---------------------------|--------------|
| 0 | No Port | +\$0 |
| 2 | Two Tablet Ports Opposite | +\$20 |

*Specify for models HML2ST and HML2STDF only

HON BRANDED FABRICS

GRADE 1

Centurion
Compass
Contourette Polyurethane
Dapper
Hamilton
Inertia
Optic

GRADE 2

Appoint Seating
Clyde
Dotty
Rush
Seed
Spin Seating
Whisper Vinyl

GRADE 3

In Season
Purl
Silvertex™ Vinyl

GRADE L

Denver Leather

For a complete list of fabrics, including partnership fabrics, go to hon.com/fabricsandfinishes.

Reference Fabric Color Combinations on pages 20-24 for color codes and legend on page 21 for lead times. For additional HON to Supply COM fabric grade pricing, go to honready.hon.com and click on the HON to Supply COM link.

 For Fire Code model, availability and ordering method, refer to pages 28-31. Available on select models, contact HON Customer Support for availability.

DUAL FABRIC COM YARDAGE

Due to fabric pattern nesting and potential reduction of fabric yield, some dual fabric models may require more total yardage than standard models.

| | FRAME/ARMS | BACK/SEAT CUSHION |
|------------|------------|-------------------|
| HML1SDF.N | 1.5 yd | 2.0 yd |
| HML1SDF.A | 4.0 yd | 2.0 yd |
| HML1SDF.B | 4.0 yd | 2.0 yd |
| HML2SDF.N | 2.2 yd | 3.5 yd |
| HML2SDF.A | 4.0 yd | 3.5 yd |
| HML2SDF.B | 4.0 yd | 3.5 yd |
| HML3SDF.N | 2.8 yd | 5.2 yd |
| HML3SDF.A | 5.4 yd | 5.2 yd |
| HML3SDF.B | 5.4 yd | 5.2 yd |
| HML2STDF.N | 2.8 yd | 3.5 yd |
| HML2STDF.A | 5.4 yd | 3.5 yd |
| HML2STDF.B | 5.4 yd | 3.5 yd |



HML1S

LOUNGE

Single Seat

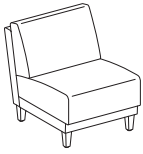

Armless

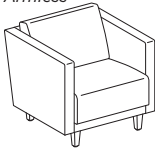

Straight Arms

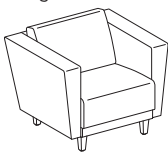

Tapered Arms

DIMENSIONS

| | | | |
|-----------------------------|-----|-----------------------------------|------------|
| Depth: | 31½ | Ship Weight (armless): | 61 |
| Height: | 29¾ | Ship Weight (with straight arms): | 77 |
| Seat Width: | 23½ | Ship Weight (with tapered arms): | 85 |
| Back Width: | 23½ | Cube (armless): | 19.8 |
| Back Height: | 19 | Cube (with straight arms): | 19.8 |
| Width (armless): | 23½ | Cube (with tapered arms): | 19.8 |
| Width (with straight arms): | 29¾ | COM (armless): | 3.0 |
| Width (with tapered arms): | 35 | COM (with straight arms): | 5.1 |
| Arm Width: | 23½ | COM (with tapered arms): | 5.1 |
| Seat to Floor Height: | 16 | Weight Rating: | 300lbs. |
| Usable Seat Depth: | 18¾ | | (per seat) |

FABRIC PRICE CODES

| | | | |
|----------|---------------|-----------|---------------|
| 1 | \$1186 | 8 | \$1600 |
| 2 | \$1258 | 9 | \$1654 |
| 3 | \$1330 | 10 | \$1708 |
| 4 | \$1384 | 11 | \$1762 |
| 5 | \$1438 | 12 | \$1816 |
| 6 | \$1492 | L | \$1786 |
| 7 | \$1546 | | |

HML2S

LOUNGE

Two-Seat

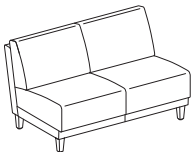

Armless



Straight Arms

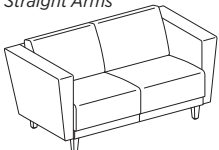

Tapered Arms

DIMENSIONS

| | | | |
|-----------------------------|-----|-----------------------------------|------------|
| Depth: | 31½ | Ship Weight (armless): | 100 |
| Height: | 29¾ | Ship Weight (with straight arms): | 116 |
| Seat Width: | 48 | Ship Weight (with tapered arms): | 124 |
| Back Width: | 48 | Cube (armless): | 35.6 |
| Back Height: | 19 | Cube (with straight arms): | 35.6 |
| Width (armless): | 48 | Cube (with tapered arms): | 35.6 |
| Width (with straight arms): | 54¾ | COM (armless): | 5.0 |
| Width (with tapered arms): | 59½ | COM (with straight arms): | 7.6 |
| Arm Width: | 48 | COM (with tapered arms): | 7.6 |
| Seat to Floor Height: | 16 | Weight Rating: | 300lbs. |
| Usable Seat Depth: | 18¾ | | (per seat) |

FABRIC PRICE CODES

| | | | |
|----------|---------------|-----------|---------------|
| 1 | \$1791 | 8 | \$2481 |
| 2 | \$1911 | 9 | \$2571 |
| 3 | \$2031 | 10 | \$2661 |
| 4 | \$2121 | 11 | \$2751 |
| 5 | \$2211 | 12 | \$2841 |
| 6 | \$2301 | L | \$2791 |
| 7 | \$2391 | | |

HON Recommendation: HML1S.A.PNS__TS.P7A - List Price \$1558

HOW TO SPECIFY

| | | | | |
|--|--|--|--|--|
| <p>Select Model Number</p> <p>H M L 1 S .</p> | <p>Select Arm Type</p> <p>N Armless A Straight Arms (+ \$300) B Tapered Arms (+ \$350)</p> <p>A .</p> | <p>Select Fabric</p> <p>See page 131</p> <p>P N S 0 0 7 .</p> | <p>Select Leg Type</p> <p>TS Tapered Square TR Tapered Round</p> <p>T S .</p> | <p>Select Leg Color</p> <p>P6N Textured Satin Chrome P7A Textured Charcoal H Bourbon Cherry (+ \$100) F Shaker Cherry (+ \$100) N Mahogany (+ \$100) C Harvest (+ \$100) D Natural Maple (+ \$100) MOCH Mocha (+ \$100) PINC Pinnacle (+ \$100) COGN Cognac (+ \$100) LLA1 Lowell Ash (+ \$100) LNRI Natural Recon (+ \$100) LPE1 Phantom Ecru (+ \$100) LPT1 Portico Teak (+ \$100) LSW1 Skyline Walnut (+ \$100)</p> <p>P 7 A</p> |
|--|--|--|--|--|

1 Leg options - Tapered Square (TS) and Tapered Round (TR) are available in 2 poly and 13 woodgrain options.



HML3S

LOUNGE

Three-Seat

DIMENSIONS

| | | | |
|-----------------------------|-----|-----------------------------------|------------|
| Depth: | 31½ | Ship Weight (armless): | 141 |
| Height: | 29¼ | Ship Weight (with straight arms): | 157 |
| Seat Width: | 71½ | Ship Weight (with tapered arms): | 165 |
| Back Width: | 71½ | Cube (armless): | 48.9 |
| Back Height: | 19 | Cube (with straight arms): | 48.9 |
| Width (armless): | 71½ | Cube (with tapered arms): | 48.9 |
| Width (with straight arms): | 77½ | COM (armless): | 7.2 |
| Width (with tapered arms): | 82½ | COM (with straight arms): | 8.9 |
| Arm Width: | 71½ | COM (with tapered arms): | 9.4 |
| Seat to Floor Height: | 16 | Weight Rating: | 300 lbs. |
| Usable Seat Depth: | 18¾ | | (per seat) |

FABRIC PRICE CODES

| | | | |
|----------|---------------|-----------|---------------|
| 1 | \$2423 | 8 | \$3458 |
| 2 | \$2603 | 9 | \$3593 |
| 3 | \$2783 | 10 | \$3728 |
| 4 | \$2918 | 11 | \$3863 |
| 5 | \$3053 | 12 | \$3998 |
| 6 | \$3188 | L | \$3923 |
| 7 | \$3323 | | |

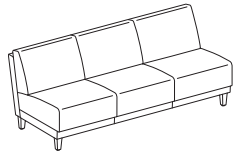

Armless

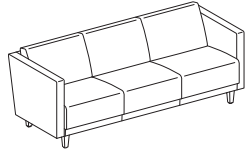

Straight Arms

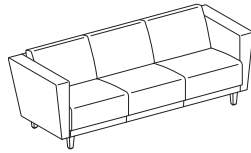

Tapered Arms

HON Recommendation: HML3S.A.PNS__TS.P7A - List Price \$2903

HOW TO SPECIFY

| | | | | |
|-----------------------------------|--|---|--|---|
| <p>Select Model Number</p> | <p>Select Arm Type</p> <p>N Armless A Straight Arms (+ \$300) B Tapered Arms (+ \$350)</p> | <p>Select Fabric</p> <p>See page 131</p> | <p>Select Leg Type</p> <p>TS Tapered Square TR Tapered Round</p> | <p>Select Leg Color</p> <p>P6N Textured Satin Chrome P7A Textured Charcoal H Bourbon Cherry (+ \$100) F Shaker Cherry (+ \$100) N Mahogany (+ \$100) C Harvest (+ \$100) D Natural Maple (+ \$100) MOCH Mocha (+ \$100) PINC Pinnacle (+ \$100) COGN Cognac (+ \$100) LLA1 Lowell Ash (+ \$100) LNR1 Natural Recon (+ \$100) LPE1 Phantom Ecreu (+ \$100) LPT1 Portico Teak (+ \$100) LSW1 Skyline Walnut (+ \$100)</p> |
| <p>H M L 3 S .</p> | <p>A .</p> | <p>P N S 0 0 7 .</p> | <p>T S .</p> | <p>P 7 A</p> |

! Leg options - Tapered Square (TS) and Tapered Round (TR) are available in 2 poly and 13 woodgrain options.



HML2ST

LOUNGE

Two-Seat with Table

DIMENSIONS

| | | | |
|-----------------------------|-----|-----------------------------------|------------|
| Depth: | 31½ | Ship Weight (armless): | 146 |
| Height: | 29¼ | Ship Weight (with straight arms): | 162 |
| Seat Width: | 71½ | Ship Weight (with tapered arms): | 170 |
| Back Width: | 71½ | Cube (armless): | 48.9 |
| Back Height: | 19 | Cube (with straight arms): | 48.9 |
| Width (armless): | 71½ | Cube (with tapered arms): | 48.9 |
| Width (with straight arms): | 77½ | COM (armless): | 5.8 |
| Width (with tapered arms): | 82½ | COM (with straight arms): | 7.6 |
| Arm Width: | 71½ | COM (with tapered arms): | 7.7 |
| Seat to Floor Height: | 16 | Weight Rating: | 300 lbs. |
| Usable Seat Depth: | 18¾ | | (per seat) |

FABRIC PRICE CODES

| | | | |
|----------|---------------|-----------|---------------|
| 1 | \$2634 | 8 | \$3462 |
| 2 | \$2778 | 9 | \$3570 |
| 3 | \$2922 | 10 | \$3678 |
| 4 | \$3030 | 11 | \$3786 |
| 5 | \$3138 | 12 | \$3894 |
| 6 | \$3246 | L | \$3834 |
| 7 | \$3354 | | |

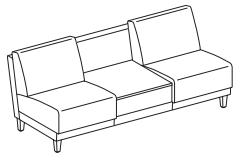

Armless

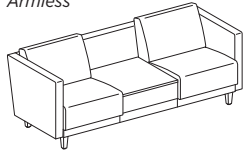

Straight Arms

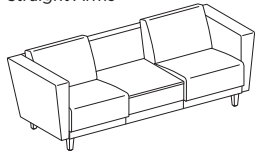

Tapered Arms

NOTES: Offers a table between the seats that provides separation and a usable worksurface. Table available with two grommet and an accessory port option.

HON Recommendation: HML2ST.A.PNS__TS.P7A.N.G1.0 - List Price \$3118

HOW TO SPECIFY

| Select Model Number | Select Arm Type | Select Fabric | Select Leg Type | Select Leg Color | Select Laminate | Select Cut Out | Accessory Port Location |
|---------------------|--|---------------|--|---|--|--|--|
| HML2ST | <p>N Armless</p> <p>A Straight Arms (+ \$300)</p> <p>B Tapered Arms (+ \$350)</p> | See page 131 | <p>TS Tapered Square</p> <p>TR Tapered Round</p> | <p>P6N Textured Satin Chrome</p> <p>P7A Textured Charcoal</p> <p>H Bourbon Cherry (+ \$100)</p> <p>F Shaker Cherry (+ \$100)</p> <p>N Mahogany (+ \$100)</p> <p>C Harvest (+ \$100)</p> <p>D Natural Maple (+ \$100)</p> <p>MOCH Mocha (+ \$100)</p> <p>PINC Pinnacle (+ \$100)</p> <p>COGN Cognac (+ \$100)</p> <p>LLA1 Lowell Ash (+ \$100)</p> <p>LNRI Natural Recon (+ \$100)</p> <p>LPE1 Phantom Ecrú (+ \$100)</p> <p>LPT1 Portico Teak (+ \$100)</p> <p>LSW1 Skyline Walnut (+ \$100)</p> | See Chart on page 130 L2 (+ \$125) | <p>N No Cutout</p> <p>G Round Grommet Cutout (+ \$30)</p> <p>G1 Pop-Up Port Cutout (+ \$40)</p> | <p>0 No Port</p> <p>2 Two Tablet Ports Opposite (+ \$20)</p> |
| HML2ST | A | PNS007 | TS | P7A | N | G1 | 0 |

! Leg options - Tapered Square (TS) and Tapered Round (TR) are available in 2 poly and 8 woodgrain options.



HGRMTAC

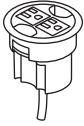

SIN 71-302

POWER HUB

3" Grommet Mount

DIMENSIONS

Ship Weight: 1.3
Cube: 0.2

LIST PRICE

\$106

NOTES: Fits in 3" round grommet holes. Field installed with Plug-and-play ease. Two grounded AC power outlets. Includes 6' cord with three-prong plug.

ⓘ Available in black only (no color designation so use .X)

HGRMTAC2

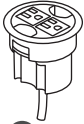

SIN 71-302

3" ROUND POWER GROMMET

2 Outlets, 10' Cord

DIMENSIONS

Ship Weight: 1.5
Cube: 0.2

LIST PRICE

\$133

NOTES: Power Modules will also work with standing-height applications for 10500 Series™ and Voi® desks. Optional Memory Control allows preset worksurface heights for consistency. Ships separately. Dynamic load capacity when worksurface is moving is 300 lbs. Includes 10' cord with three-prong plug. Fits in 3" round grommet holes on the following product lines: Coordinate™, Huddle, Motivate®, all laminate and veneer casegoods series, and Systems Worksurfaces. Two grounded AC power outlets. Field installed with Plug-and-play ease.

ⓘ Available in black finish only, no specification needed.

HGRMTUSB2

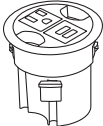

SIN 71-302

POWER/USB HUB

3" Grommet Mount

DIMENSIONS

Ship Weight: 1.3 ⓘ
Cube: 0.2

LIST PRICE

\$209

NOTES: One grounded AC power outlet with 2 USB ports. UL Listed.

ⓘ Available in black only (no color designation so use .X)

HFTTAL14



SIN 711-11

TABLET ACCESSORY

Laminate

DIMENSIONS

Diameter: 14 Ship Weight: 6.0
Height from Table Top: 10 Cube: 2.5

LIST PRICE

\$348

NOTES: Use with Collaborative Cube and Cylinder tables for additional workspace. Attaches to tables through ports. Multiple port location options are available. Tablet pivots/swivels toward the user.

HTPWRGROM1

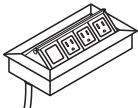

SIN 711-11

POP-UP PORT

DIMENSIONS

Ship Weight: 5.0
Cube: 0.3

LIST PRICE

\$360

NOTES: Fits into 4" x 8" cutout. Specify G1 cutout in table top. Pop-up Port provides three power ports and one blank data receptacle. Sits flush with worksurface when closed. Finish is anodized aluminum. Includes 6' cord with three-prong plug.

HON Recommendation: HTPWRGROM1 - List Price \$360

HOW TO SPECIFY

Select Model Number

| | | | | | | |
|---|---|---|---|---|---|---|
| H | G | R | M | T | A | C |
|---|---|---|---|---|---|---|

GROVE® Dual Fabric

GSA SIN 711-17



Icon Legend on page 17

HML1SDF

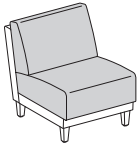

Armless

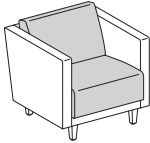

Straight Arms

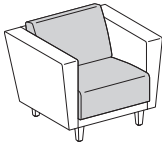

Tapered Arms

SINGLE SEAT LOUNGE

Dual Fabric

DIMENSIONS

| | | | |
|-----------------------------|-----|-----------------------------------|----------|
| Depth: | 31½ | Ship Weight (armless): | 61 |
| Height: | 29¾ | Ship Weight (with straight arms): | 77 |
| Seat Width: | 23½ | Ship Weight (with tapered arms): | 85 |
| Back Width: | 23½ | Cube (armless): | 19.8 |
| Back Height: | 19 | Cube (with straight arms): | 19.8 |
| Width (armless): | 23½ | Cube (with tapered arms): | 19.8 |
| Width (with straight arms): | 29¾ | COM (armless): | 3.0 |
| Width (with tapered arms): | 35 | COM (with straight arms): | 5.1 |
| Arm Width: | 23½ | COM (with tapered arms): | 5.1 |
| Seat to Floor Height: | 16 | Weight Rating: | 300 lbs. |
| Usable Seat Depth: | 18¾ | (per seat) | |

FABRIC PRICE CODES

1 \$1261

Add to Base Price Above

| | Frame/ Arms | Back/Seat Cushions |
|-----------|----------------|-----------------------|
| 2 | \$36 | \$48 |
| 3 | \$72 | \$96 |
| 4 | \$99 | \$132 |
| 5 | \$126 | \$168 |
| 6 | \$153 | \$204 |
| 7 | \$180 | \$240 |
| 8 | \$207 | \$276 |
| 9 | \$234 | \$312 |
| 10 | \$261 | \$348 |
| 11 | \$288 | \$384 |
| 12 | \$315 | \$420 |
| L | \$300 | \$400 |

For dual fabric models, start with the base price, then add the additional amount for the back and seat from the corresponding matrix to determine the final list price. Choose any combination of fabric grades for the back and seat.

Example: HML1SDF base price (\$1261) + Grade 2 frame/arms fabric (add \$36) + Grade 4 back/seat fabric (add \$132) = Total \$1429 List
 HML1SDF base price (\$1261) + Grade 5 frame/arms fabric (add \$126) + Grade 3 back/seat fabric (add \$96) = Total \$1483 List

HON Recommendation: HML1SDF.A.PNS___.PNS___.TS.P7A - List Price \$1645

HOW TO SPECIFY

| | | | | | |
|---|--|--|--|--|--|
| Select Model Number H M L 1 S D F . | Select Arm Type N Armless A Straight Arms (+ \$300) B Tapered Arms (+ \$350) | Select Frame/Arms Fabric See page 131 P N S 0 0 4 . | Select Back/Seat Cushions Fabric See page 131 P N S 0 0 7 . | Select Leg Type TS Tapered Square TR Tapered Round T S . | Select Leg Color P6N Textured Satin Chrome P7A Textured Charcoal H Bourbon Cherry (+ \$100) F Shaker Cherry (+ \$100) N Mahogany (+ \$100) C Harvest (+ \$100) D Natural Maple (+ \$100) MOCH Mocha (+ \$100) PINC Pinnacle (+ \$100) COGN Cognac (+ \$100) LLA1 Lowell Ash (+ \$100) LNR1 Natural Recon (+ \$100) LPE1 Phantom Ecru (+ \$100) LPT1 Portico Teak (+ \$100) LSW1 Skyline Walnut (+ \$100) |
|---|--|--|--|--|--|

! Leg options - Tapered Square (TS) and Tapered Round (TR) are available in 2 poly and 8 woodgrain options.



Icon Legend on page 17

GROVE® Dual Fabric

HML2SDF

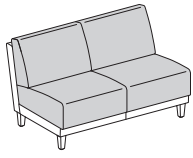

Armless

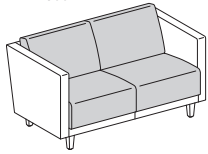

Straight Arms

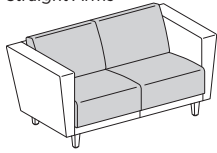

Tapered Arms

TWO-SEAT LOUNGE

Dual Fabric

DIMENSIONS

| | | | |
|-----------------------------|-----|-----------------------------------|----------|
| Depth: | 31½ | Ship Weight (armless): | 100 |
| Height: | 29¼ | Ship Weight (with straight arms): | 116 |
| Seat Width: | 48 | Ship Weight (with tapered arms): | 124 |
| Back Width: | 48 | Cube (armless): | 35.6 |
| Back Height: | 19 | Cube (with straight arms): | 35.6 |
| Width (armless): | 48 | Cube (with tapered arms): | 35.6 |
| Width (with straight arms): | 54¼ | COM (armless): | 5.0 |
| Width (with tapered arms): | 59½ | COM (with straight arms): | 7.6 |
| Arm Width: | 48 | COM (with tapered arms): | 7.6 |
| Seat to Floor Height: | 16 | Weight Rating: | 300 lbs. |
| Usable Seat Depth: | 18¾ | (per seat) | |

FABRIC PRICE CODES

| | | | |
|--------------------------------|------------------------|-------------------------------|--|
| 1 | \$1866 | | |
| <i>Add to Base Price Above</i> | | | |
| | Frame/ Arms | Back/Seat Cushions | |
| 2 | \$60 | \$84 | |
| 3 | \$120 | \$168 | |
| 4 | \$165 | \$231 | |
| 5 | \$210 | \$294 | |
| 6 | \$255 | \$357 | |
| 7 | \$300 | \$420 | |
| 8 | \$345 | \$483 | |
| 9 | \$390 | \$546 | |
| 10 | \$435 | \$609 | |
| 11 | \$480 | \$672 | |
| 12 | \$525 | \$735 | |
| L | \$500 | \$700 | |

For dual fabric models, start with the base price, then add the additional amount for the back and seat from the corresponding matrix to determine the final list price. Choose any combination of fabric grades for the back and seat.

Example: HML2SDF base price (\$1866) + Grade 2 frame/arms fabric (add \$60) + Grade 4 back/seat fabric (add \$231) = Total \$2157 List
 HML2SDF base price (\$1866) + Grade 5 frame/arms fabric (add \$210) + Grade 3 back/seat fabric (add \$168) = Total \$2244 List

HON Recommendation: HML2SDF.A.PNS__PNS__TS.P7A - List Price \$2310

HOW TO SPECIFY

| Select Model Number | Select Arm Type | Select Frame/Arms Fabric | Select Back/Seat Cushions Fabric | Select Leg Type | Select Leg Color |
|---------------------|--|--------------------------|----------------------------------|---------------------------------------|---|
| | N Armless A Straight Arms (+ \$300) B Tapered Arms (+ \$350) | See page 131 | See page 131 | TS Tapered Square TR Tapered Round | P6N Textured Satin Chrome P7A Textured Charcoal H Bourbon Cherry (+ \$100) F Shaker Cherry (+ \$100) N Mahogany (+ \$100) C Harvest (+ \$100) D Natural Maple (+ \$100) MOCH Mocha (+ \$100) PINC Pinnacle (+ \$100) COGN Cognac (+ \$100) LLA1 Lowell Ash (+ \$100) LNR1 Natural Recon (+ \$100) LPE1 Phantom Ecru (+ \$100) LPT1 Portico Teak (+ \$100) LSW1 Skyline Walnut (+ \$100) |
| HML2SDF | A | PNS004 | PNS007 | TS | P7A |

! Leg options - Tapered Square (TS) and Tapered Round (TR) are available in 2 poly and 8 woodgrain options.

GROVE® Dual Fabric

GSA SIN 711-17



Icon Legend on page 17

HML3SDF

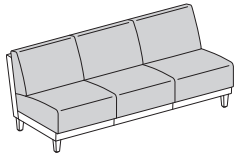

Armless

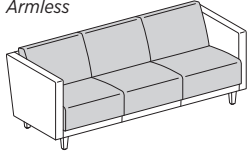

Straight Arms

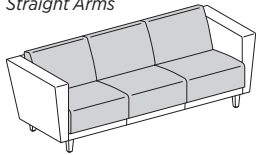

Tapered Arms

THREE-SEAT LOUNGE

Dual Fabric

DIMENSIONS

| | | | |
|-----------------------------|-----|-----------------------------------|----------|
| Depth: | 31½ | Ship Weight (armless): | 141 |
| Height: | 29¼ | Ship Weight (with straight arms): | 157 |
| Seat Width: | 71½ | Ship Weight (with tapered arms): | 165 |
| Back Width: | 71½ | Cube (armless): | 48.9 |
| Back Height: | 19 | Cube (with straight arms): | 48.9 |
| Width (armless): | 71½ | Cube (with tapered arms): | 48.9 |
| Width (with straight arms): | 77½ | COM (armless): | 7.2 |
| Width (with tapered arms): | 82½ | COM (with straight arms): | 8.9 |
| Arm Width: | 71½ | COM (with tapered arms): | 9.4 |
| Seat to Floor Height: | 16 | Weight Rating: | 300 lbs. |
| Usable Seat Depth: | 18¾ | (per seat) | |

FABRIC PRICE CODES

| | | | |
|--------------------------------|------------------------|-------------------------------|--|
| 1 | \$2498 | | |
| <i>Add to Base Price Above</i> | | | |
| | Frame/ Arms | Back/Seat Cushions | |
| 2 | \$72 | \$132 | |
| 3 | \$144 | \$264 | |
| 4 | \$198 | \$363 | |
| 5 | \$252 | \$462 | |
| 6 | \$306 | \$561 | |
| 7 | \$360 | \$660 | |
| 8 | \$414 | \$759 | |
| 9 | \$468 | \$858 | |
| 10 | \$522 | \$957 | |
| 11 | \$576 | \$1056 | |
| 12 | \$630 | \$1155 | |
| L | \$600 | \$1100 | |

For dual fabric models, start with the base price, then add the additional amount for the back and seat from the corresponding matrix to determine the final list price. Choose any combination of fabric grades for the back and seat.

Example: HML3SDF base price (\$2498) + Grade 2 frame/arms fabric (add \$72) + Grade 4 back/seat fabric (add \$363) = Total \$2933 List
 HML3SDF base price (\$2498) + Grade 5 frame/arms fabric (add \$252) + Grade 3 back/seat fabric (add \$264) = Total \$3014 List

HON Recommendation: HML3SDF.A.PNS__PNS__.TS.P7A - List Price \$3002

HOW TO SPECIFY

| Select Model Number | Select Arm Type | Select Frame/Arms Fabric | Select Back/Seat Cushions Fabric | Select Leg Type | Select Leg Color |
|---------------------|---|--------------------------|----------------------------------|---|--|
| | N Armless A Straight Arms (+ \$300) B Tapered Arms (+ \$350) | See page 131 | See page 131 | TS Tapered Square TR Tapered Round | P6N Textured Satin Chrome P7A Textured Charcoal H Bourbon Cherry (+ \$100) F Shaker Cherry (+ \$100) N Mahogany (+ \$100) C Harvest (+ \$100) D Natural Maple (+ \$100) MOCH Mocha (+ \$100) PINC Pinnacle (+ \$100) COGN Cognac (+ \$100) LLA1 Lowell Ash (+ \$100) LNR1 Natural Recon (+ \$100) LPE1 Phantom Ecru (+ \$100) LPT1 Portico Teak (+ \$100) LSW1 Skyline Walnut (+ \$100) |
| HML3SDF | A | PNS004 | PNS007 | TS | P7A |

! Leg options - Tapered Square (TS) and Tapered Round (TR) are available in 2 poly and 8 woodgrain options.



GROVE® Dual Fabric

HML2STDF

TWO-SEAT WITH TABLE

Dual Fabric

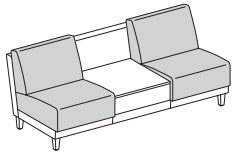

Armless

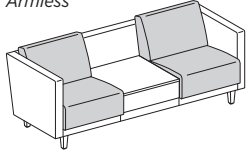

Straight Arms

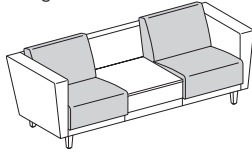

Tapered Arms

DIMENSIONS

| | | | |
|-----------------------------|-----|-----------------------------------|----------|
| Depth: | 31½ | Ship Weight (armless): | 146 |
| Height: | 29¼ | Ship Weight (with straight arms): | 162 |
| Seat Width: | 71½ | Ship Weight (with tapered arms): | 170 |
| Back Width: | 71½ | Cube (armless): | 48.9 |
| Back Height: | 19 | Cube (with straight arms): | 48.9 |
| Width (armless): | 71½ | Cube (with tapered arms): | 48.9 |
| Width (with straight arms): | 77½ | COM (armless): | 5.8 |
| Width (with tapered arms): | 82½ | COM (with straight arms): | 7.6 |
| Arm Width: | 71½ | COM (with tapered arms): | 7.7 |
| Seat to Floor Height: | 16 | Weight Rating: | 300 lbs. |
| Usable Seat Depth: | 18¾ | (per seat) | |

FABRIC PRICE CODES

| | | | |
|--------------------------------|---------------|------------------------|-------------------------------|
| 1 | \$2709 | | |
| <i>Add to Base Price Above</i> | | | |
| | | Frame/ Arms | Back/Seat Cushions |
| 2 | \$72 | | \$84 |
| 3 | \$144 | | \$168 |
| 4 | \$198 | | \$231 |
| 5 | \$252 | | \$294 |
| 6 | \$306 | | \$357 |
| 7 | \$360 | | \$420 |
| 8 | \$414 | | \$483 |
| 9 | \$468 | | \$546 |
| 10 | \$522 | | \$609 |
| 11 | \$576 | | \$672 |
| 12 | \$630 | | \$735 |
| L | \$600 | | \$700 |

NOTES: Offers a table between the seats that provides separation and a usable worksurface. Table available with two grommet and an accessory port option.

HON Recommendation: HML2STDF.A.PNS__PNS__TS.P7A.N.G1.0 - List Price \$3205

HOW TO SPECIFY

| Select Model Number | Select Arm Type | Select Frame/Arms Fabric | Select Back/Seat Cushions Fabric | Select Leg Type | Select Leg Color | Select Laminate | Select Cut Out | Accessory Port Location |
|---------------------|---|--------------------------|----------------------------------|---|--|--|---|---|
| | N Armless A Straight Arms (+ \$300) B Tapered Arms (+ \$350) | See page 131 | See page 131 | TS Tapered Square TR Tapered Round | P6N Textured Satin Chrome P7A Textured Charcoal H Bourbon Cherry (+ \$100) F Shaker Cherry (+ \$100) N Mahogany (+ \$100) C Harvest (+ \$100) D Natural Maple (+ \$100) MOCH Mocha (+ \$100) PINC Pinnacle (+ \$100) COGN Cognac (+ \$100) LLA1 Lowell Ash (+ \$100) LNRI Natural Recon (+ \$100) LPE1 Phantom Ecru (+ \$100) LPT1 Portico Teak (+ \$100) LSW1 Skyline Walnut (+ \$100) | See Chart on page 130 L2 (+ \$125) | N No Cutout G Round Grommet Cutout (+ \$30) G1 Pop-Up Port Cutout (+ \$40) | 0 No Port 2 Two Tablet Ports Opposite (+ \$20) |
| HML2STDF | A | PNS004 | PNS007 | TS | P7A | N | G1 | 0 |

! Leg options - Tapered Square (TS) and Tapered Round (TR) are available in 2 poly and 8 woodgrain options.



HGRMTAC

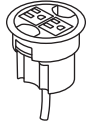

SIN 71-302

POWER HUB

3" Grommet Mount

DIMENSIONS

Ship Weight: 1.3
Cube: 0.2

LIST PRICE

\$106

NOTES: Fits in 3" round grommet holes. Field installed with Plug-and-play ease. Two grounded AC power outlets. Includes 6' cord with three-prong plug.

ⓘ Available in black only (no color designation so use .X)

HGRMTAC2

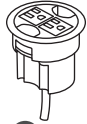

SIN 71-302

3" ROUND POWER GROMMET

2 Outlets, 10' Cord

DIMENSIONS

Ship Weight: 1.5
Cube: 0.2

LIST PRICE

\$133

NOTES: Power Modules will also work with standing-height applications for 10500 Series™ and Voi® desks. Optional Memory Control allows preset worksurface heights for consistency. Ships separately. Dynamic load capacity when worksurface is moving is 300 lbs. Includes 10' cord with three-prong plug. Fits in 3" round grommet holes on the following product lines: Coordinate™, Huddle, Motivate®, all laminate and veneer caseload series, and Systems Worksurfaces. Two grounded AC power outlets. Field installed with Plug-and-play ease.

ⓘ Available in black finish only, no specification needed.

HGRMTUSB2

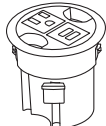

SIN 71-302

POWER/USB HUB

3" Grommet Mount

DIMENSIONS

Ship Weight: 1.3 ⓘ
Cube: 0.2

LIST PRICE

\$209

NOTES: One grounded AC power outlet with 2 USB ports. UL Listed.

ⓘ Available in black only (no color designation so use .X)

HFTTAL14



SIN 711-11

TABLET ACCESSORY

Laminate

DIMENSIONS

Diameter: 14 Ship Weight: 6.0
Height from Table Top: 10 Cube: 2.5

LIST PRICE

\$348

NOTES: Use with Collaborative Cube and Cylinder tables for additional workspace. Attaches to tables through ports. Multiple port location options are available. Tablet pivots/swivels toward the user.

HTPWRGROM1

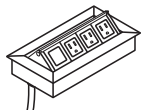

SIN 711-11

POP-UP PORT

DIMENSIONS

Ship Weight: 5.0
Cube: 0.3

LIST PRICE

\$360

NOTES: Fits into 4" x 8" cutout. Specify G1 cutout in table top. Pop-up Port provides three power ports and one blank data receptacle. Sits flush with worksurface when closed. Finish is anodized aluminum. Includes 6' cord with three-prong plug. HON Recommendation: HTPWRGROM1 - List Price \$360

HON Recommendation: HTPWRGROM1 - List Price \$360

HOW TO SPECIFY

Select
Model Number

H G R M T A C

GUESTSTACKER® 4030 Series



GuestStacker Stacking Chair shown in Regatta.

GUESTSTACKER® 4030 SERIES

Support your people with a comfortable chair whenever needed, then quickly clear the room. GuestStacker helps you make the most of valuable floor space by stacking six high on the floor or 28 high on a cart. Each set of four chairs provides ergonomic support to users with a contoured seat and back that are molded to fit the natural curves of your body. When you need to put guests at ease for any length of time, you need GuestStacker chairs.



FEATURES

- Ships four chairs per carton.
- Chairs stack six high on the floor.
- Copolymer resin seat and back shell.
- Integrated lumbar support delivers long-lasting comfort.
- Wall-saver design protects walls and cabinets.
- Tubular steel frame adds durability.
- Optional ganging glides create straight rows.
- Stacks up to 28 high on HON Model 4033 Cart.
- Ships fully assembled.
- Warranted for users up to 300 lbs.

GUESTSTACKER® 4030 Series

GSA SIN 711-19



Icon Legend on page 17

H4031



STACKING CHAIRS

Textured Copolymer Seat & Back
Painted Legs — Black (T) ONLY

DIMENSIONS

| | | | |
|--------------|-----|-----------------------|----------|
| Depth: | 21½ | Seat to Floor Height: | 17½ |
| Width: | 21 | Usable Seat Depth: | 17½ |
| Height: | 31 | Ship Weight: | 51 |
| Seat Depth: | 19 | Cube: | 12.9 |
| Seat Width: | 18 | Weight Rating: | 300 lbs. |
| Back Width: | 20 | | |
| Back Height: | 11 | | |

LIST PRICE PER CARTON

\$579
(reference single unit @ \$144.75)

- ⊕ 4030 Series is ordered and shipped four (4) chairs per carton. Pricing shown is per carton. Each set of four (one carton), must have the same shell/frame color combination. Ordering 2 of Model H4031 will result in 2 cartons being shipped, giving you 8 chairs.
- ⚠ Shipped fully assembled — 4 chairs per carton. All GuestStacker® shell colors are CA Technical Bulletin 133 compliant (no upcharge).

H4033

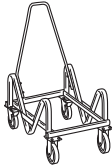

CART FOR STACKING CHAIRS

DIMENSIONS

| | | | |
|---------|-----|--------------|------|
| Depth: | 35½ | Ship Weight: | 40 Ⓢ |
| Width: | 21¾ | Cube: | 8.9 |
| Height: | 37¾ | | |

LIST PRICE

\$485

- NOTES: Holds 28 stack chairs (6'-8"), some assembly required. (Chairs stack 6 high without cart.)
⚠ Specify Black paint (T) ONLY.

H4039

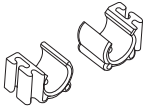

GANGING CHAIR GLIDES

Box of 48

DIMENSIONS

| | |
|--------------|------|
| Ship Weight: | 1 Ⓢ |
| Cube: | 0.04 |

LIST PRICE

\$94

HON Recommendation: H4031.LA.T - List Price \$579

HOW TO SPECIFY

| | | |
|--|---|--|
| <p>Select Model Number</p> <p>H 4 0 3 1 .</p> | <p>Select Shell Color</p> <p>LA Lava MB Mulberry ON Onyx RE Regatta</p> <p>L A .</p> | <p>Select Frame</p> <p>T Black</p> <p>T</p> |
|--|---|--|

IGNITION®



Ignition® 2.0 Task Chairs shown with Empower® Benching.

IGNITION®

People come in all shapes and sizes, which is why Ignition does as well. From guest and lounge chairs to executive seating, Ignition allows you to mix and match adjustment features, back height, lumbar, and other options to fit your chair to your needs. It's the easy, affordable way to furnish an entire workplace in style and comfort. Ignition fits who you are, where you work and how you work.



FEATURES

IGNITION®

- Ignition Series seating addresses the needs of the total office with Executive, Task, Stool, Guest and Lounge Seating Solutions.
- Three different back sizes, three different controls and multiple arm options to fit you and how you work.
- Back height adjustment moves the back up or down to fit various body sizes.
- Contoured back on multi-purpose seating offers greater comfort than typical stack chairs or stools.
- Lounge seating available in two- and three-seat options.
- Warranted for users up to 300 lbs. (450 lbs. for Big and Tall and 600 lbs. for Three-Seat Lounge)
- Multi-purpose chair stacks four high.



IGNITION® 2.0

- Optional adjustable lumbar allows users to tailor their support.
- Passive movement back adjusts with you.
- Multiple arm options to accommodate different requirements.
- Available in 5 colors of ilira®-stretch mesh.
- Molded foam seat for better support and added comfort.
- Available in Black and Titanium frame.
- Warranted for users up to 300 lbs.

IGNITION® Options

MODEL OPTIONS

HITL1



Task Low-Back

Pneumatic, Back Height Adjustment, Swivel, Tilt, Tilt Tension, Tilt Lock

HITL2



Task Low-Back

Pneumatic, Back Height Adjustment, Synchro-tilt, Tilt Tension, Tilt Lock, Seat Glide

HITL3



Task Low-Back

Pneumatic, Back Height Adjustment, Synchro-tilt, Back Angle Adjustment, Tilt Tension, Tilt Lock, Seat Glide

HITS5



Task Stool

Pneumatic, Swivel Back Height Adjustment, Adjustable Footrest

HIWM1



Mid-Back

Pneumatic, Back Height Adjustment, Swivel, Tilt, Tilt Tension, Tilt Lock

HIWM2



Mid-Back

Pneumatic, Back Height Adjustment, Synchro-tilt, Tilt Tension, Tilt Lock, Seat Glide

HIWM3



Mid-Back

Pneumatic, Back Height Adjustment, Synchro-tilt, Back Angle Adjustment, Tilt Tension, Tilt Lock, Seat Glide

HIEH1



Executive High-Back

Pneumatic, Back Height Adjustment, Swivel, Tilt, Tilt Tension, Tilt Lock

HIEH2



Executive High-Back

Pneumatic, Back Height Adjustment, Synchro-tilt, Tilt Tension, Seat Glide

HIEH3



Executive High-Back

Pneumatic, Back Height Adjustment, Synchro-tilt, Back Angle Adjustment, Tilt Tension, Seat Glide

HIWM8



Task Mid-Back

Big and Tall, Pneumatic, Swivel-tilt, Tilt Tension

HITLM



Task Low-Back

ilira®-stretch Mesh Back, Pneumatic, Swivel, Synchro-tilt, Tilt Tension, Tilt Lock, Optional Lumbar Support

HIWMM



Task Mid-Back

ilira®-stretch Mesh Back, Pneumatic, Swivel, Synchro-tilt, Tilt Tension, Tilt Lock, Optional Lumbar Support

HITSM

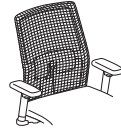

Task Low-Back Stool

ilira®-stretch Mesh Back, Pneumatic, Swivel, Synchro-tilt, Tilt Tension, Tilt Lock, Optional Lumbar Support

MODEL OPTIONS

HIGCL



Guest Chair

Fixed Arms, Glides

HIL2L

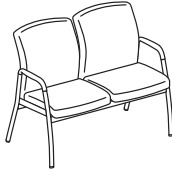

Two-Seat Lounge

Fixed Arms, Glides

HILTl

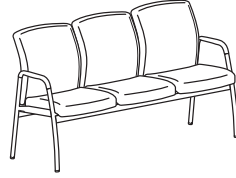

Three-Seat Lounge

Fixed Arms, Glides

HIB50

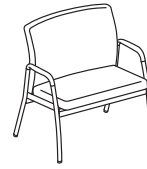

Bariatric Lounge

Fixed Arms, Glides

HIHC



Hip Chair

Fixed Arms, Glides

HIGS6

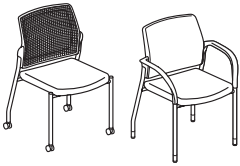

Multi-Purpose

Four Legs

HISB6

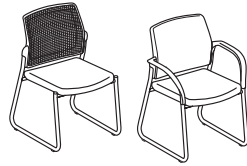

Multi-Purpose

Sled Base

HICS7

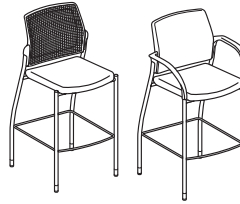

Café-Height Stool

Four Legs

HIGS6DF - Dual Fabric

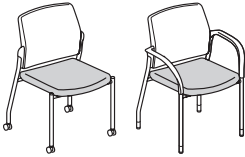

Multi-Purpose

Four Legs

HISB6DF - Dual Fabric

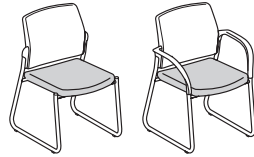

Multi-Purpose

Sled Base

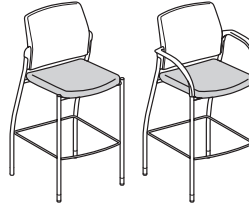

HICS7DF - Dual Fabric







Café-Height Stool

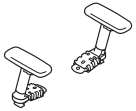

Four Legs

IGNITION® Task Chair Options

| ARM STYLE | CODE | DESCRIPTION | PRICE |
|--|----------|--------------------------------------|---------------|
| | N | Armless | +\$0 |
|  | F | Fixed Arms | +\$65 |
|  | A | Height and Width Adjustable Arms | +\$75 |
|  | V | All-Adjustable Arms (includes Pivot) | +\$115 |
|  | P | Fixed Polished Aluminum Arms | +\$150 |

| CASTERS | CODE | DESCRIPTION | PRICE |
|--|----------|---|--------------|
|  | A | All Surface Caster <i>*Must specify for model HIWM8 only</i> | +\$0 |
|  | H | Hard Caster | +\$0 |
|  | S | Soft Caster | +\$30 |

| BACK STYLE | CODE | DESCRIPTION | PRICE |
|---|----------|-------------|-------------|
|  | U | Upholstered | +\$0 |
|  | M | Mesh | +\$0 |

| BASE | CODE | DESCRIPTION | PRICE |
|---|-----------|-------------------|---------------|
|  | SB | Standard Base | +\$0 |
|  | PA | Polished Aluminum | +\$110 |

HON BRANDED FABRICS

GRADE 1

Attire
Centurion
Compass
Contourette Polyurethane
Dapper
Hamilton
Inertia
Optic

GRADE 2

Appoint Seating
Clyde
Dotty
Rush
Seed
Spin Seating
Whisper Vinyl

GRADE 3

In Season
Purl
Silvertex™ Vinyl

GRADE L

Denver Leather
(Black Only)

For a complete list of fabrics, including partnership fabrics, go to hon.com/fabricsandfinishes.

Reference Fabric Color Combinations on pages 20-24 for color codes and legend on page 21 for lead times. For additional HON to Supply COM fabric grade pricing, go to honready.hon.com and click on the HON to Supply COM link.

*Denver Leather is only available in Black.

 For Fire Code model, availability and ordering method, refer to pages 28-31. Available on select models, contact HON Customer Support for availability.



Icon Legend on page 17

HITL1



TASK LOW-BACK

Pneumatic
Back Height Adjustment
Swivel
Tilt
Tilt Tension
Tilt Lock
Functions: **A, B, E, J, K, L**
(Function Key on pages 18-19)

DIMENSIONS

| | | |
|---------------------------|---------------------------------|----------|
| Upholstered Back | Adjustable Arms Width: | 17-19½ |
| Width: 17½ | Fixed Arms Width: | 20 |
| Upholstered Back | Seat to Floor Height: | 17-21½ |
| Height: 18¾-21¾ | Usable Seat Depth: | 15¾ |
| Mesh Back Width: 17½ | Ship Weight (upholstered back): | 50 Ⓢ |
| Mesh Back Height: 20¾-23¼ | Ship Weight (mesh back): | 45 Ⓢ |
| Depth: 36 | Cube (upholstered back): | 11.1 |
| Width: 27½ | Cube (mesh back): | 11.1 |
| Height: 41 | COM (upholstered back): | 2.0 |
| Seat Depth: 17 | COM (mesh back): | 1.0 |
| Seat Width: 19 | Weight Rating: | 300 lbs. |

FABRIC PRICE CODES

| | | | |
|----------|--------------|-----------|--------------|
| 1 | \$551 | 8 | \$827 |
| 2 | \$599 | 9 | \$863 |
| 3 | \$647 | 10 | \$899 |
| 4 | \$683 | 11 | \$935 |
| 5 | \$719 | 12 | \$971 |
| 6 | \$755 | L | \$851 |
| 7 | \$791 | | |

NOTES: See page 152 for arm packs.

HITL2



TASK LOW-BACK

Pneumatic
Back Height Adjustment
Synchro-tilt
Tilt Tension
Tilt Lock
Seat Glide
Functions:
A, B, D, E, J, A-D, L
(Function Key on pages 18-19)

DIMENSIONS

| | | |
|---------------------------|---------------------------------|----------|
| Upholstered Back | Adjustable Arms Width: | 17-19½ |
| Width: 17½ | Fixed Arms Width: | 20 |
| Upholstered Back | Seat to Floor Height: | 17-21½ |
| Height: 19½-22½ | Usable Seat Depth: | 15½-17½ |
| Mesh Back Width: 17½ | Ship Weight (upholstered back): | 54 Ⓢ |
| Mesh Back Height: 20¾-23¼ | Ship Weight (mesh back): | 49 Ⓢ |
| Depth: 38½ | Cube (upholstered back): | 11.1 |
| Width: 27½ | Cube (mesh back): | 11.1 |
| Height: 43 | COM (upholstered back): | 2.0 |
| Seat Depth: 16-18 | COM (mesh back): | 1.0 |
| Seat Width: 19 | Weight Rating: | 300 lbs. |

FABRIC PRICE CODES

| | | | |
|----------|--------------|-----------|---------------|
| 1 | \$620 | 8 | \$896 |
| 2 | \$668 | 9 | \$932 |
| 3 | \$716 | 10 | \$968 |
| 4 | \$752 | 11 | \$1004 |
| 5 | \$788 | 12 | \$1040 |
| 6 | \$824 | L | \$920 |
| 7 | \$860 | | |

NOTES: See page 152 for arm packs.

HITL3



TASK LOW-BACK

Pneumatic
Back Height Adjustment
Synchro-tilt
Back Angle Adjustment
Tilt Tension
Tilt Lock
Seat Glide
Functions:
A, B, D, E, A-D, A-E, L
(Function Key on pages 18-19)

DIMENSIONS

| | | |
|---------------------------|---------------------------------|----------|
| Upholstered Back | Adjustable Arms Width: | 17-19½ |
| Width: 17½ | Fixed Arms Width: | 20 |
| Upholstered Back | Seat to Floor Height: | 17-21½ |
| Height: 20¾-23¾ | Usable Seat Depth: | 14½-16½ |
| Mesh Back Width: 17½ | Ship Weight (upholstered back): | 58 Ⓢ |
| Mesh Back Height: 20¾-23¼ | Ship Weight (mesh back): | 53 Ⓢ |
| Depth: 39 | Cube (upholstered back): | 11.1 |
| Width: 27 | Cube (mesh back): | 11.1 |
| Height: 44 | COM (upholstered back): | 2.0 |
| Seat Depth: 16-18 | COM (mesh back): | 1.0 |
| Seat Width: 19 | Weight Rating: | 300 lbs. |

FABRIC PRICE CODES

| | | | |
|----------|--------------|-----------|---------------|
| 1 | \$662 | 8 | \$938 |
| 2 | \$710 | 9 | \$974 |
| 3 | \$758 | 10 | \$1010 |
| 4 | \$794 | 11 | \$1046 |
| 5 | \$830 | 12 | \$1082 |
| 6 | \$866 | L | \$962 |
| 7 | \$902 | | |

NOTES: See page 152 for arm packs.

HON Recommendation: HITL1.A.H.M.CU__T.SB - List Price \$626

HOW TO SPECIFY

| Select Model Number | Select Arm Type | Select Caster/Glide | Select Back Type | Select Fabric | Select Frame | Select Base |
|---|---|---------------------------------------|------------------|----------------|--|-------------|
| N Armless F Fixed Arms - Black (+ \$65) A Height and Width Adjustable Arms (+ \$75) V All-Adjustable Arms (includes Pivot) (+ \$115) P Fixed Arms - Polished (+ \$150) | H Hard Caster S Soft Caster (+ \$30) | U Upholstered M Mesh | See page 147 | T Black | SB Standard Base PA Polished Aluminum (+ \$110) | |
| HITL1 | A | H | M | CU10 | T | SB |



HIWM1



MID-BACK

Pneumatic
Back Height Adjustment
Swivel
Tilt
Tilt Tension
Tilt Lock
Functions: **A, B, E, J, K, L**
(Function Key on pages 18-19)

DIMENSIONS

Upholstered Back Width: 18½
Upholstered Back Height: 21-24
Mesh Back Width: 19
Mesh Back Height: 21½-24
Depth: 35½
Width: 27
Height: 44
Seat Depth: 18
Seat Width: 20
Adjustable Arms Width: 17-19½
Fixed Arms Width: 20

Seat to Floor Height: 17-21½
Usable Seat Depth: 17½
Ship Weight (upholstered back): 54 **Ⓢ**
Ship Weight (mesh back): 48 **Ⓢ**
Cube (upholstered back): 11.3
Cube (mesh back): 11.3
COM (upholstered back): 2.0
COM (mesh back): 1.0
Weight Rating: 300 lbs.

FABRIC PRICE CODES

| | | | |
|----------|--------------|-----------|---------------|
| 1 | \$603 | 8 | \$879 |
| 2 | \$651 | 9 | \$915 |
| 3 | \$699 | 10 | \$951 |
| 4 | \$735 | 11 | \$987 |
| 5 | \$771 | 12 | \$1023 |
| 6 | \$807 | L | \$903 |
| 7 | \$843 | | |

NOTES: See page 152 for arm packs.

HIWM2



MID-BACK

Pneumatic
Back Height Adjustment
Synchro-tilt
Tilt Tension
Tilt Lock
Seat Glide
Functions:
A, B, D, E, J, A-D, L
(Function Key on pages 18-19)

DIMENSIONS

Upholstered Back Width: 18½
Upholstered Back Height: 21-24
Mesh Back Width: 19
Mesh Back Height: 21½-24
Depth: 38
Width: 27
Height: 46½
Seat Depth: 17-19
Seat Width: 20
Adjustable Arms Width: 17-19½
Fixed Arms Width: 20

Seat to Floor Height: 17¼-21¾
Usable Seat Depth: 16¼-18¼
Ship Weight (upholstered back): 58 **Ⓢ**
Ship Weight (mesh back): 52 **Ⓢ**
Cube (upholstered back): 11.3
Cube (mesh back): 11.3
COM (upholstered back): 2.0
COM (mesh back): 1.0
Weight Rating: 300 lbs.

FABRIC PRICE CODES

| | | | |
|----------|--------------|-----------|---------------|
| 1 | \$670 | 8 | \$946 |
| 2 | \$718 | 9 | \$982 |
| 3 | \$766 | 10 | \$1018 |
| 4 | \$802 | 11 | \$1054 |
| 5 | \$838 | 12 | \$1090 |
| 6 | \$874 | L | \$970 |
| 7 | \$910 | | |

NOTES: See page 152 for arm packs.

HIWM3



MID-BACK

Pneumatic
Back Height Adjustment
Synchro-tilt
Back Angle Adjustment
Tilt Tension
Tilt Lock
Seat Glide
Functions:
A, B, D, E, A-D, A-E, L
(Function Key on pages 18-19)

DIMENSIONS

Upholstered Back Width: 18½
Upholstered Back Height: 21-24
Mesh Back Width: 19
Mesh Back Height: 21½-24
Depth: 39
Width: 27
Height: 44
Seat Depth: 17-19
Seat Width: 20
Adjustable Arms Width: 17-19½
Fixed Arms Width: 20

Seat to Floor Height: 17¼-21¾
Usable Seat Depth: 15¼-17¼
Ship Weight (upholstered back): 63 **Ⓢ**
Ship Weight (mesh back): 58 **Ⓢ**
Cube (upholstered back): 11.3
Cube (mesh back): 11.3
COM (upholstered back): 2.0
COM (mesh back): 1.0
Weight Rating: 300 lbs.

FABRIC PRICE CODES

| | | | |
|----------|--------------|-----------|---------------|
| 1 | \$714 | 8 | \$990 |
| 2 | \$762 | 9 | \$1026 |
| 3 | \$810 | 10 | \$1062 |
| 4 | \$846 | 11 | \$1098 |
| 5 | \$882 | 12 | \$1134 |
| 6 | \$918 | L | \$1014 |
| 7 | \$954 | | |

NOTES: See page 152 for arm packs.

HON Recommendation: HIWM2.A.H.M.CU__T.SB - List Price \$745

HOW TO SPECIFY

| Select Model Number | Select Arm Type | Select Caster/Glide | Select Back Type | Select Fabric | Select Frame | Select Base |
|---|---|---------------------------------------|------------------|----------------|--|-------------|
| N Armless F Fixed Arms - Black (+ \$65) A Height and Width Adjustable Arms (+ \$75) V All-Adjustable Arms (includes Pivot) (+ \$115) P Fixed Arms - Polished (+ \$150) | H Hard Caster S Soft Caster (+ \$30) | U Upholstered M Mesh | See page 147 | T Black | SB Standard Base PA Polished Aluminum (+ \$110) | |
| HIWM1 | A | H | M | CU10 | T | SB |

IGNITION®



Icon Legend on page 17

HIEH1



EXECUTIVE HIGH-BACK

Pneumatic
Back Height Adjustment
Swivel
Tilt
Tilt Tension
Tilt Lock
Functions: **A, B, E, F, K, L**
(Function Key on pages 18-19)

DIMENSIONS

Depth: 38½
Width: 27
Height: 47½
Seat Depth: 18
Seat Width: 20
Back Width: 20
Back Height: 24¾-27¾
Arm Width: 20
Seat to Floor Height: 16¾-21¼
Usable Seat Depth: 17⅞
Ship Weight: 56
16.0
COM: 2.5
Weight Rating: 300 lbs.

FABRIC PRICE CODES

| | | | |
|---|-------|----|--------|
| 1 | \$626 | 8 | \$902 |
| 2 | \$674 | 9 | \$938 |
| 3 | \$722 | 10 | \$974 |
| 4 | \$758 | 11 | \$1010 |
| 5 | \$794 | 12 | \$1046 |
| 6 | \$830 | L | \$926 |
| 7 | \$866 | | |

NOTES: See page 152 for arm packs.

HIEH2



EXECUTIVE HIGH-BACK

Pneumatic
Back Height Adjustment
Synchro-tilt
Tilt Tension
Seat Glide
Functions:
A, B, D, E, J, A-D, L
(Function Key on pages 18-19)

DIMENSIONS

Depth: 41
Width: 27
Height: 49
Seat Depth: 17-19
Seat Width: 20
Back Width: 19½
Back Height: 24¾-27¾
Arm Width: 20
Seat to Floor Height: 17-21½
Usable Seat Depth: 16½-18
Ship Weight: 61
16.0
COM: 2.5
Weight Rating: 300 lbs.

FABRIC PRICE CODES

| | | | |
|---|-------|----|--------|
| 1 | \$695 | 8 | \$971 |
| 2 | \$743 | 9 | \$1007 |
| 3 | \$791 | 10 | \$1043 |
| 4 | \$827 | 11 | \$1079 |
| 5 | \$863 | 12 | \$1115 |
| 6 | \$899 | L | \$995 |
| 7 | \$935 | | |

NOTES: See page 152 for arm packs.

HIEH3

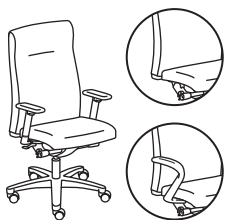

EXECUTIVE HIGH-BACK

Pneumatic
Back Height Adjustment
Synchro-tilt
Back Angle Adjustment
Tilt Tension
Seat Glide
Functions:
A, B, D, E, A-D, A-E, L
(Function Key on pages 18-19)

DIMENSIONS

Depth: 45½
Width: 27
Height: 49
Seat Depth: 17-19
Seat Width: 20
Back Width: 19½
Back Height: 24¾-27¾
Arm Width: 20
Seat to Floor Height: 17-21½
Usable Seat Depth: 15¼-17¼
65
16.0
COM: 2.5
Weight Rating: 300 lbs.

FABRIC PRICE CODES

| | | | |
|---|-------|----|--------|
| 1 | \$737 | 8 | \$1013 |
| 2 | \$785 | 9 | \$1049 |
| 3 | \$833 | 10 | \$1085 |
| 4 | \$869 | 11 | \$1121 |
| 5 | \$905 | 12 | \$1157 |
| 6 | \$941 | L | \$1037 |
| 7 | \$977 | | |

NOTES: See page 152 for arm packs.

HON Recommendation: HIEH1.F.H.U.CU__T.SB - List Price \$691

HOW TO SPECIFY

| Select Model Number | Select Arm Type | Select Caster/Glide | Select Back Type | Select Fabric | Select Frame | Select Base |
|---------------------|--|---|------------------|---------------|--------------|--|
| H I E H 1 | N F Fixed Arms - Black (+ \$65) A Height and Width Adjustable Arms (+ \$75) V All-Adjustable Arms (includes Pivot) (+ \$115) P Fixed Arms - Polished (+ \$150) | H Hard Caster S Soft Caster (+ \$30) | U Upholstered | See page 147 | T Black | SB Standard Base PA Polished Aluminum (+ \$110) |
| | | | | | | |



HITS5



TASK STOOL

Pneumatic Swivel Back Height Adjustment
Adjustable Footrest
Functions: **A, B, E**
(Function Key on pages 18-19)

DIMENSIONS

| | | | |
|--------------------------|---------|---------------------------------|-------------|
| Upholstered Back Width: | 17½ | Adjustable Arms Width: | 17-19½ |
| Upholstered Back Height: | 18¾-21¾ | Fixed Arms Width: | 20 |
| Mesh Back Width: | 17½ | Seat to Floor Height: | 23⅝-33⅝ |
| Mesh Back Height: | 20¾-23¾ | Usable Seat Depth: | 15¾ |
| Depth: | 27½ | Ship Weight (upholstered back): | 56 Ⓞ |
| Width: | 27 | Ship Weight (mesh back): | 51 Ⓞ |
| Height: | 44 | Cube (upholstered back): | 11.3 |
| Seat Depth: | 17 | Cube (mesh back): | 11.3 |
| Seat Width: | 19 | COM (upholstered back): | 2.0 |
| | | COM (mesh back): | 1.0 |
| | | Weight Rating: | 300 lbs. |

FABRIC PRICE CODES

| | | | |
|----------|--------------|-----------|---------------|
| 1 | \$650 | 8 | \$926 |
| 2 | \$698 | 9 | \$962 |
| 3 | \$746 | 10 | \$998 |
| 4 | \$782 | 11 | \$1034 |
| 5 | \$818 | 12 | \$1070 |
| 6 | \$854 | L | \$950 |
| 7 | \$890 | | |

NOTES: See page 152 for arm packs.

HIWM8



TASK MID-BACK

Big and Tall
Pneumatic Swivel-tilt Tilt Tension
Functions: **A, E, F, K, L**
(Function Key on pages 18-19)

DIMENSIONS

| | | | |
|--------------|-----|-----------------------|----------|
| Depth: | 28 | Arm Width: | 23-25½ |
| Width: | 32¼ | Seat to Floor Height: | 17⅞-20⅜ |
| Height: | 43⅞ | Usable Seat Depth: | 19½ |
| Seat Depth: | 19½ | Ship Weight: | 60 |
| Seat Width: | 23½ | Cube: | 16.0 |
| Back Width: | 23½ | COM: | 3.0 |
| Back Height: | 23 | Weight Rating: | 450 lbs. |

FABRIC PRICE CODES

| | | | |
|----------|---------------|-----------|---------------|
| 1 | \$1198 | 8 | \$1612 |
| 2 | \$1270 | 9 | \$1666 |
| 3 | \$1342 | 10 | \$1720 |
| 4 | \$1396 | 11 | \$1774 |
| 5 | \$1450 | 12 | \$1828 |
| 6 | \$1504 | L | \$1798 |
| 7 | \$1558 | | |

NOTES: See page 152 for arm packs.

HON Recommendation: HITS5.A.H.M.CU__T.SB - List Price \$725

HOW TO SPECIFY

| Select Model Number | Select Arm Type | Select Caster/Glide | Select Back Type | Select Fabric | Select Frame | Select Base |
|---|--|---------------------------------------|------------------|----------------|-------------------------|-------------|
| N Armless F Fixed Arms - Black (+ \$65) A Height and Width Adjustable Arms (+ \$75) V All-Adjustable Arms (includes Pivot) (+ \$115) P Fixed Arms - Polished (+ \$150) | H Hard Caster S Soft Caster (+ \$30) A All Surface Caster (available on model HIWM8 only) <i>H and S caster options not available on model HIWM8</i> | U Upholstered M Mesh | See page 147 | T Black | SB Standard Base | |
| HITS5 | A | H | M | CU10 | T | SB |



HIATA



ADJUSTABLE ARMS

Height and Width
Functions: **S**
(Function Key on pages 18-19)

DIMENSIONS

Adjustable Arms Width: 17-19½
Height from Seat: 8-11
Ship Weight: 8 **S**
Cube: 1.0

LIST PRICE

\$117

HIAAA

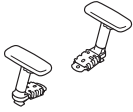

ALL-ADJUSTABLE ARMS

Height, Width, Depth and Pivot

DIMENSIONS

Adjustable Arms Width: 17-20
Height from Seat: 7-11
Ship Weight: 8 **S**
Cube: 1.0

LIST PRICE

\$158

HIFHA



FIXED HEIGHT ARMS

DIMENSIONS

Arm Width: 20
Height from Seat: 9½
Ship Weight: 7 **S**
Cube: 1.0

LIST PRICE

\$107

HIPAA

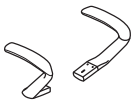

POLISHED ALUMINUM ARMS

Fixed Height

DIMENSIONS

Arm Width: 20
Height from Seat: 9½
Ship Weight: 10 **S**
Cube: 1.0

LIST PRICE

\$180

HOW TO SPECIFY

Select Model Number

Select Color

T Black
Color option not available on HIPAA



HIATA.

T

IGNITION® 2.0 Options

| ARM STYLE | CODE | DESCRIPTION | PRICE |
|---|----------|--------------------------------------|---------------|
| | N | Armless | +\$0 |
|  | F | Fixed Arms | +\$65 |
|  | A | Height and Width Adjustable Arms | +\$75 |
|  | V | All-Adjustable Arms (includes Pivot) | +\$115 |
|  | P | Fixed Polished Aluminum Arms | +\$150 |

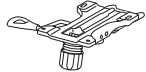
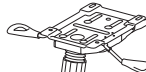
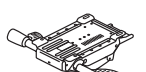
| CASTERS | CODE | DESCRIPTION | PRICE |
|---|----------|---------------------|--------------|
|  | H | Hard Caster | +\$0 |
|  | S | Soft Caster | +\$30 |
|  | R | Roll Control Caster | +\$50 |



| MECHANISM | CODE | DESCRIPTION | PRICE |
|---|-----------|--|---------------|
|  | Y0 | Synchro-Tilt A, E, J, K, L | +\$0 |
|  | Y1 | Synchro-Tilt w/Seat Slider A, D, E, J, K, L | +\$20 |
|  | Y2 | Advanced Synchro-Tilt A, D, E, J, L, A-D | +\$65 |
|  | Y3 | Synchro-Tilt with Independent Back Angle A, D, E, J, L, A-E | +\$105 |
|  | S1 | Limited Synchro-Tilt A, E, J, K, L | +\$0 |

**Only available on HITSM*

| LUMBAR | CODE | DESCRIPTION | PRICE |
|--------|-----------|-------------------|--------------|
| | NL | No Lumbar | +\$0 |
| | AL | Adjustable Lumbar | +\$30 |

**Adjustable Lumbar not available on CAL 133 (FC) models*

| BACK STYLE | CODE | DESCRIPTION | PRICE |
|--|-----------|-------------|-------------|
| <i>ilira®-stretch mesh back options:</i> | | | |
| | IM | Black | +\$0 |
| | IF | Fog | +\$0 |
| | IC | Charcoal | +\$0 |
| | IH | Chai | +\$0 |
| | IY | Navy | +\$0 |

| BASE | CODE | DESCRIPTION | PRICE |
|---|-----------|-------------------|---------------|
|  | SB | Standard Base | +\$0 |
|  | PA | Polished Aluminum | +\$110 |

| FRAME | CODE | DESCRIPTION | PRICE |
|-------|-----------|----------------|--------------|
| | T | Black Frame | +\$0 |
| | TI | Titanium Frame | +\$35 |

IGNITION® 2.0

Dimensions

TASK DIMENSIONS

| MODEL | HIWMM | HITLM | HITSM | HITLMKD | HIWMMKD |
|-------------------------|---------|---------|---------|---------|---------|
| Overall Width Armless | 21 | 20 | 20 | 20 | 21 |
| Overall Width with Arms | A | 27 | 26 | 26 | 27 |
| Overall Depth | 24 | 22 | 22 | 22 | 24 |
| Overall Height | S1 | - | - | 52½ | - |
| | Y0/Y1 | 43¾ | 40½ | - | 40½ |
| | Y2 | 44½ | 41¼ | - | - |
| | Y3 | 44½ | 41¼ | - | - |
| | W5 | 45¼ | 41½ | - | - |
| Seat Width | 20 | 18½ | 18½ | 18½ | 20 |
| Seat Depth (cushion) | 2½ | 2½ | 2½ | 2½ | 2½ |
| Usable Seat Depth | S1 | - | - | 16 | - |
| | Y0 | 17¾ | 16 | - | 16 |
| | Y1 | 17½-19½ | 15½-17½ | - | 15½-17½ |
| | Y2 | 16¼-19¼ | 15¾-18½ | - | - |
| | Y3 | 16½-19½ | 16¼-18¾ | - | - |
| | W5 | 17½-20 | 16¾-18¾ | - | - |
| Seat Height | S1 | - | - | 22⅞-31¾ | - |
| | Y0/Y1 | 16⅜-21¼ | 16¾-21¼ | - | 16¾-21¼ |
| | Y2 | 17⅞-21½ | 17⅞-21½ | - | - |
| | Y3 | 17½-21½ | 17¾-21¾ | - | - |
| | W5 | 16¾-21⅞ | 16¾-21½ | - | - |
| Back Width | 19 | 17½ | 17½ | 17½ | 19 |
| Back Height | 29 | 25½ | 25½ | 25½ | 29 |
| Ship Weight Armless | S1 | - | - | 44 | - |
| | Y0 | 38 | 38 | - | 38 |
| | Y1 | 38 | 38 | - | 38 |
| | Y2 | 42 | 42 | - | - |
| | Y3 | 46 | 45 | - | - |
| | W5 | 45 | 44 | - | - |
| Ship Weight with Arms | S1 | - | - | 51 | - |
| | Y0 | 45 | 45 | - | 45 |
| | Y1 | 45 | 45 | - | 45 |
| | Y2 | 49 | 49 | - | - |
| | Y3 | 53 | 52 | - | - |
| | W5 | 52 | 51 | - | - |
| Width Between Arms | F | 20¼ | 19 | 19 | 19 |
| | P | 20¼ | 19 | 19 | 19 |
| | A | 24⅜-27¼ | 18½-20½ | 18½-20⅝ | 18½-20½ |
| | V | 12½-27½ | 11½-26½ | 11½-26⅝ | 11½-26½ |
| Cube | 11.1 | 11.1 | 11.1 | 5.6 | 6.3 |
| COM | 1.0 | 1.0 | 1.0 | - | - |
| Weight Capacity | 300 lbs | 300 lbs | 300 lbs | 300 lbs | 300 lbs |



HITLM

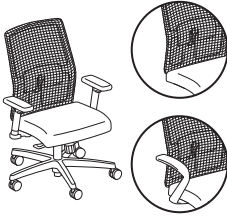

TASK LOW-BACK

- ilira®-stretch Mesh Back**
- Pneumatic
- Swivel
- Synchro-tilt
- Tilt Tension
- Tilt Lock
- Optional Lumbar Support

DIMENSIONS

| | | | |
|--------------------|---------|--------------------------|--------------|
| Depth: | 22 | Seat to Floor Height: | 16¾-21¼ |
| Height: | 40½ | Usable Seat Depth: | 16 |
| Seat Depth: | 16 | Ship Weight (with arms): | 45 \$ |
| Seat Width: | 18½ | Ship Weight (armless): | 38 \$ |
| Back Width: | 17½ | Cube: | 11.1 |
| Back Height: | 25½ | COM: | 1.0 |
| Width (with arms): | 26 | Weight Rating: | 300 lbs. |
| Width (armless): | 20 | | |
| Arm Width: | 11½-26½ | | |

FABRIC PRICE CODES

| | | | |
|----------|--------------|-----------|--------------|
| 1 | \$465 | 8 | \$603 |
| 2 | \$489 | 9 | \$621 |
| 3 | \$513 | 10 | \$639 |
| 4 | \$531 | 11 | \$657 |
| 5 | \$549 | 12 | \$675 |
| 6 | \$567 | L | \$665 |
| 7 | \$585 | | |

! Dimensions, weights and cubes shown above are for models using the Ignition® YO control only. See page 154 for all other control specifications.

HIWMM

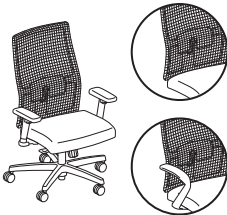

TASK MID-BACK

- ilira®-stretch Mesh Back**
- Pneumatic
- Swivel
- Synchro-tilt
- Tilt Tension
- Tilt Lock
- Optional Lumbar Support

DIMENSIONS

| | | | |
|--------------------|---------|--------------------------|--------------|
| Depth: | 24 | Seat to Floor Height: | 16¾-21¼ |
| Height: | 43¾ | Usable Seat Depth: | 17¾ |
| Seat Depth: | 17¾ | Ship Weight (with arms): | 45 \$ |
| Seat Width: | 20 | Ship Weight (armless): | 38 \$ |
| Back Width: | 19 | Cube: | 11.1 |
| Back Height: | 29 | COM: | 1.0 |
| Width (with arms): | 27 | Weight Rating: | 300 lbs. |
| Width (armless): | 21 | | |
| Arm Width: | 12½-27½ | | |

FABRIC PRICE CODES

| | | | |
|----------|--------------|-----------|--------------|
| 1 | \$508 | 8 | \$646 |
| 2 | \$532 | 9 | \$664 |
| 3 | \$556 | 10 | \$682 |
| 4 | \$574 | 11 | \$700 |
| 5 | \$592 | 12 | \$718 |
| 6 | \$610 | L | \$708 |
| 7 | \$628 | | |

! Dimensions, weights and cubes shown above are for models using the Ignition® YO control only. See page 154 for all other control specifications.

HITSM

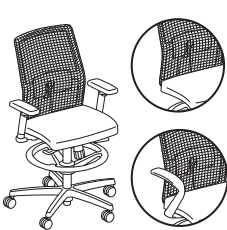

TASK LOW-BACK STOOL

- ilira®-stretch Mesh Back**
- Pneumatic
- Swivel
- Synchro-tilt
- Tilt Tension
- Tilt Lock
- Optional Lumbar Support

DIMENSIONS

| | | | |
|--------------------|---------|--------------------------|--------------|
| Depth: | 22 | Seat to Floor Height: | 22⅞-31¾ |
| Height: | 52½ | Usable Seat Depth: | 16 |
| Seat Depth: | 16 | Ship Weight (with arms): | 51 \$ |
| Seat Width: | 18½ | Ship Weight (armless): | 44 \$ |
| Back Width: | 17½ | Cube: | 11.1 |
| Back Height: | 25½ | COM: | 1.0 |
| Width (with arms): | 26 | Weight Rating: | 300 lbs. |
| Width (armless): | 20 | | |
| Arm Width: | 11½-26⅔ | | |

FABRIC PRICE CODES

| | | | |
|----------|--------------|-----------|--------------|
| 1 | \$556 | 8 | \$694 |
| 2 | \$580 | 9 | \$712 |
| 3 | \$604 | 10 | \$730 |
| 4 | \$622 | 11 | \$748 |
| 5 | \$640 | 12 | \$766 |
| 6 | \$658 | L | \$756 |
| 7 | \$676 | | |

! Dimensions, weights and cubes shown above are for models using the Ignition® S1 control only. See page 154 for all other control specifications.

! Not available in Polished Aluminum Base.

HON Recommendation: HIWMM.Y2.A.H.IM.CU__AL.SB.T - List Price \$678

HOW TO SPECIFY

| Select Model Number | Select Control Type | Select Arm Type | Select Caster | Select Mesh | Select Fabric | Select Lumbar | Select Base | Select Frame |
|---------------------|---|---|--|--|---------------|---|--|---|
| HITLM | Y0 Synchro-Tilt Y1 Synchro-Tilt w/ Seat Slider (+ \$20) Y2 Advanced Synchro-Tilt (+ \$65) Y3 Synchro-Tilt with Independent Back Angle (+ \$105) S1 Limited Synchro-Tilt (for HITSM only) <i>Specify S1 for HITSM model ONLY</i> | N Armless A Height and Width Adjustable Arms (+ \$75) V All-Adjustable Arms (includes pivot) (+ \$115) F Fixed Arms (+ \$65) P Fixed Arms - Polished (+ \$150) | H Hard Caster S Soft Caster (+ \$30) R Roll Control Caster (+ \$50) | IM Black IF Fog IC Charcoal IH Chai IY Navy | See page 147 | NL No Lumbar AL Adjustable Lumbar (+ \$30) | SB Standard Base PA Polished Aluminum (+ \$110) | T Black TI Titanium (+ \$35) |
| HITLM | Y2 | A | H | IM | CU10 | AL | SB | T |

IGNITION® 2.0



Icon Legend on page 17

HITLMKD

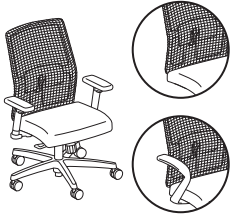

TASK LOW-BACK

ilira®-stretch Mesh Back
 Pneumatic
 Swivel
 Synchro-tilt
 Tilt Tension
 Tilt Lock
 Optional Lumbar Support

DIMENSIONS

| | | | |
|--------------------|--|--------------------------|--|
| Depth: | 22 | Seat to Floor Height: | 16 ³ / ₄ -21 ¹ / ₄ |
| Height: | 40 ¹ / ₂ | Usable Seat Depth: | 16 |
| Seat Depth: | 16 | Ship Weight (with arms): | 45 Ⓢ |
| Seat Width: | 18 ¹ / ₂ | Ship Weight (armless): | 38 Ⓢ |
| Back Width: | 17 ¹ / ₂ | Cube: | 6.3 |
| Back Height: | 25 ¹ / ₂ | Weight Rating: | 300 lbs. |
| Width (with arms): | 26 | | |
| Width (armless): | 20 | | |
| Arm Width: | 11 ¹ / ₂ -26 ¹ / ₂ | | |

FABRIC PRICE CODES

1 \$425
2 \$449
3 \$473

! Dimensions, weights and cubes shown above are for models using the Ignition® Y0 control only. See page 154 for all other control specifications.

HIWMMKD

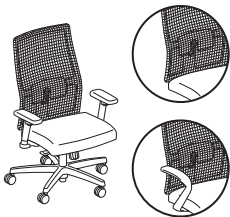

TASK MID-BACK

ilira®-stretch Mesh Back
 Pneumatic
 Swivel
 Synchro-tilt
 Tilt Tension
 Tilt Lock
 Optional Lumbar Support

DIMENSIONS

| | | | |
|--------------------|--|--------------------------|--|
| Depth: | 24 | Seat to Floor Height: | 16 ³ / ₈ -21 ¹ / ₄ |
| Height: | 43 ³ / ₄ | Usable Seat Depth: | 17 ³ / ₄ |
| Seat Depth: | 17 ³ / ₄ | Ship Weight (with arms): | 45 Ⓢ |
| Seat Width: | 20 | Ship Weight (armless): | 38 Ⓢ |
| Back Width: | 19 | Cube: | 5.6 |
| Back Height: | 29 | Weight Rating: | 300 lbs. |
| Width (with arms): | 27 | | |
| Width (armless): | 21 | | |
| Arm Width: | 12 ¹ / ₂ -27 ¹ / ₂ | | |

FABRIC PRICE CODES

1 \$468
2 \$492
3 \$516

! Dimensions, weights and cubes shown above are for models using the Ignition® Y0 control only. See page 154 for all other control specifications.

HON Recommendation: HIWMMKD.Y2.A.H.IM.CU__AL.SB.T - List Price \$638

HOW TO SPECIFY

| Select Model Number | Select Control Type | Select Arm Type | Select Caster | Select Mesh | Select Fabric | Select Lumbar | Select Base | Select Frame |
|---------------------|--|--|----------------------|--|---------------|---|-------------------------|---|
| | Y1 Synchro-Tilt w/ Seat Slider (+ \$20) Y2 Advanced Synchro-Tilt (+ \$65) | A Height and Width Adjustable Arms (+ \$75) | H Hard Caster | IM Black IF Fog IC Charcoal | See page 147 | NL No Lumbar AL Adjustable Lumbar (+ \$30) | SB Standard Base | T Black T1 Titanium (+ \$35) |
| H I W M M K D . | Y 2 . | A . | H . | I M . | C U 1 0 . | A L . | S B . | T . |



Icon Legend on page 17

IGNITION® 2.0 Accessories

HI2ATA

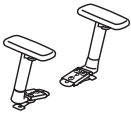

ADJUSTABLE ARMS

Height and Width
Functions: **S**
(Function Key on pages 18-19)

DIMENSIONS

Adjustable Arms Width: 17-19½
Height from Seat: 8-11
Ship Weight: 8 **S**
Cube: 1.0

LIST PRICE

\$117

HI2AAA

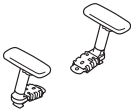

ALL-ADJUSTABLE ARMS

Height, Width, Depth and Pivot

DIMENSIONS

Adjustable Arms Width: 17-20
Height from Seat: 7-11
Ship Weight: 8 **S**
Cube: 1.0

LIST PRICE

\$158

HI2FHA



FIXED HEIGHT ARMS

DIMENSIONS

Arm Width: 20
Height from Seat: 9½
Ship Weight: 7 **S**
Cube: 1.0

LIST PRICE

\$107

HILMBR

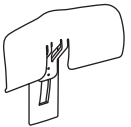

LUMBAR SUPPORT

DIMENSIONS

Ship Weight: 8 **S**
Cube: 1.0

LIST PRICE

\$30

HOW TO SPECIFY

| | |
|-----------------------------------|---|
| <p>Select Model Number</p> | <p>Select Frame</p> <p>T Black TI Titanium</p> |
| <p>HI2ATA.</p> | <p>T</p> |

IGNITION®

Guest Chair Options

| ARM STYLE | CODE | DESCRIPTION | PRICE |
|--|----------|-------------|--------------|
|  | N | Armless | +\$0 |
| | F | Fixed Arms | +\$30 |

| BACK STYLE | CODE | DESCRIPTION | PRICE |
|------------|-----------|-------------|-------------|
| | U | Upholstered | +\$0 |
| | IM | Black | +\$0 |
| | IF | Fog | +\$0 |
| | IC | Charcoal | +\$0 |
| | IH | Chai | +\$0 |
| | IY | Navy | +\$0 |

| CASTERS/ GLIDE | CODE | DESCRIPTION | PRICE |
|--|----------|-------------|--------------|
|  | H | Hard Caster | +\$0 |
| | S | Soft Caster | +\$20 |
|  | E | Glide | +\$0 |

Casters only available on HIGS6

| FRAME | CODE | DESCRIPTION | PRICE |
|-------|-------------|----------------------------|--------------|
| | T | Black | +\$0 |
| | BLCK | Textured Black | +\$0 |
| | PLAT | Textured Platinum Metallic | +\$0 |
| | PR8T | Textured Titanium | +\$35 |

By selecting PR8T, unit will be produced with titanium colored arm caps, back frame & glides



HIGCL



GUEST CHAIR

Fixed Arms
Glides

DIMENSIONS

| | | | |
|--------------|-----|-----------------------|----------|
| Depth: | 24 | Arm Width: | 19¼ |
| Width: | 23 | Seat to Floor Height: | 18½ |
| Height: | 35½ | Usable Seat Depth: | 16¾ |
| Seat Depth: | 18 | Ship Weight: | 42 |
| Seat Width: | 19½ | Cube: | 15.2 |
| Back Width: | 19½ | COM: | 2.0 |
| Back Height: | 20 | Weight Rating: | 300 lbs. |

FABRIC PRICE CODES

| | | | |
|----------|--------------|-----------|--------------|
| 1 | \$439 | 8 | \$715 |
| 2 | \$487 | 9 | \$751 |
| 3 | \$535 | 10 | \$787 |
| 4 | \$571 | 11 | \$823 |
| 5 | \$607 | 12 | \$859 |
| 6 | \$643 | L | \$739 |
| 7 | \$679 | | |

HIL2L

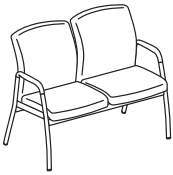

TWO-SEAT LOUNGE

Fixed Arms
Glides

DIMENSIONS

| | | | |
|-------------------|-----|-----------------------|------------------------|
| Depth: | 24½ | Arm Width: | 40 |
| Width: | 42¾ | Seat to Floor Height: | 18½ |
| Height: | 34½ | Usable Seat Depth: | 16¾ |
| Each Seat Depth: | 16¾ | Ship Weight: | 96 |
| Each Seat Width: | 19½ | Cube: | 37.1 |
| Each Back Width: | 19½ | COM: | 3.5 |
| Each Back Height: | 19 | Weight Rating: | 300 lbs. (per seat) |

FABRIC PRICE CODES

| | | | |
|----------|---------------|-----------|---------------|
| 1 | \$1343 | 8 | \$1826 |
| 2 | \$1427 | 9 | \$1889 |
| 3 | \$1511 | 10 | \$1952 |
| 4 | \$1574 | 11 | \$2015 |
| 5 | \$1637 | 12 | \$2078 |
| 6 | \$1700 | L | \$2043 |
| 7 | \$1763 | | |

HILTL

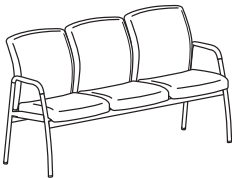

THREE-SEAT LOUNGE

Fixed Arms
Glides

DIMENSIONS

| | | | |
|-------------------|-----|-----------------------|------------------------|
| Depth: | 24½ | Arm Width: | 60¼ |
| Width: | 64 | Seat to Floor Height: | 18½ |
| Height: | 34½ | Usable Seat Depth: | 16¾ |
| Each Seat Depth: | 18 | Ship Weight: | 128 |
| Each Seat Width: | 19½ | Cube: | 37.1 |
| Each Back Width: | 19½ | COM: | 5.0 |
| Each Back Height: | 19 | Weight Rating: | 300 lbs. (per seat) |

FABRIC PRICE CODES

| | | | |
|----------|---------------|-----------|---------------|
| 1 | \$1689 | 8 | \$2379 |
| 2 | \$1809 | 9 | \$2469 |
| 3 | \$1929 | 10 | \$2559 |
| 4 | \$2019 | 11 | \$2649 |
| 5 | \$2109 | 12 | \$2739 |
| 6 | \$2199 | L | \$2689 |
| 7 | \$2289 | | |

HON Recommendation: HIGCL.E.U.CU__T - List Price \$439

HOW TO SPECIFY

| | | | | |
|---|---|---|--|--|
| <p>Select Model Number</p> <p>HIGCL.</p> | <p>Select Glide</p> <p>E Glide</p> <p>E.</p> | <p>Select Back Type</p> <p>U Upholstered</p> <p>U.</p> | <p>Select Fabric</p> <p>See page 147</p> <p>CU10.</p> | <p>Select Frame</p> <p>T Black BLCK Textured Black PLAT Textured Platinum Metallic</p> <p>T</p> |
|---|---|---|--|--|



HIB50

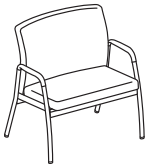

BARIATRIC LOUNGE

Fixed Arms
Glides

DIMENSIONS

| | | | |
|--------------|-----|-----------------------|----------|
| Depth: | 25½ | Arm Width: | 30 |
| Width: | 33¾ | Seat to Floor Height: | 20 |
| Height: | 35¾ | Usable Seat Depth: | 18¾ |
| Seat Depth: | 18¾ | Ship Weight: | 70 |
| Seat Width: | 29¾ | Cube: | 27.5 |
| Back Width: | 29 | COM: | 2.5 |
| Back Height: | 19¼ | Weight Rating: | 500 lbs. |

FABRIC PRICE CODES

| | | | |
|----------|---------------|-----------|---------------|
| 1 | \$1280 | 8 | \$1625 |
| 2 | \$1340 | 9 | \$1670 |
| 3 | \$1400 | 10 | \$1715 |
| 4 | \$1445 | 11 | \$1760 |
| 5 | \$1490 | 12 | \$1805 |
| 6 | \$1535 | L | \$1780 |
| 7 | \$1580 | | |

HIHC



HIP CHAIR

Fixed Arms
Glides

DIMENSIONS

| | | | |
|--------------|-----|-----------------------|----------|
| Depth: | 23 | Arm Width: | 21½ |
| Width: | 24¾ | Seat to Floor Height: | 24¾ |
| Height: | 41⅝ | Usable Seat Depth: | 16½ |
| Seat Depth: | 16½ | Ship Weight: | 37 |
| Seat Width: | 18¾ | Cube: | 19.1 |
| Back Width: | 18¼ | COM: | 1.5 |
| Back Height: | 17⅝ | Weight Rating: | 300 lbs. |

FABRIC PRICE CODES

| | | | |
|----------|--------------|-----------|--------------|
| 1 | \$616 | 8 | \$823 |
| 2 | \$652 | 9 | \$850 |
| 3 | \$688 | 10 | \$877 |
| 4 | \$715 | 11 | \$904 |
| 5 | \$742 | 12 | \$931 |
| 6 | \$769 | L | \$916 |
| 7 | \$796 | | |

HOW TO SPECIFY

| | | | | | |
|--|--|--|--|---|---|
| Select Model Number <div style="border: 1px solid black; padding: 2px; display: inline-block;">HIB50</div> | Select Arm Type F Fixed Arms | Select Glide E Glide | Select Back Type U Upholstered | Select Fabric See page 147 | Select Frame T Black BLCK Textured Black PLAT Textured Platinum Metallic |
| <div style="border: 1px solid black; padding: 2px; display: inline-block;">HIB50</div> | <div style="border: 1px solid black; padding: 2px; display: inline-block;">F</div> | <div style="border: 1px solid black; padding: 2px; display: inline-block;">E</div> | <div style="border: 1px solid black; padding: 2px; display: inline-block;">U</div> | <div style="border: 1px solid black; padding: 2px; display: inline-block;">CU10</div> | <div style="border: 1px solid black; padding: 2px; display: inline-block;">T</div> |



HIGS6

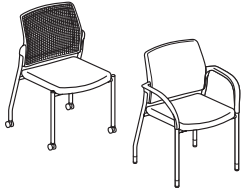

MULTI-PURPOSE

Four Legs

DIMENSIONS

| | | | |
|--------------|-----|---------------------------------|----------|
| Depth: | 21¾ | Seat to Floor Height: | 18⅝ |
| Width: | 25 | Usable Seat Depth: | 17⅝ |
| Height: | 33½ | Ship Weight (upholstered back): | 28 |
| Seat Depth: | 17⅝ | Ship Weight (mesh back): | 28 |
| Seat Width: | 18¾ | Cube (upholstered back): | 15.1 |
| Back Width: | 18¼ | Cube (mesh back): | 15.1 |
| Back Height: | 18⅝ | COM (upholstered back): | 1.5 |
| Arm Width: | 21½ | COM (mesh back): | 1.0 |
| | | Weight Rating: | 300 lbs. |

FABRIC PRICE CODES

| | | | |
|---|-------|----|-------|
| 1 | \$416 | 8 | \$623 |
| 2 | \$452 | 9 | \$650 |
| 3 | \$488 | 10 | \$677 |
| 4 | \$515 | 11 | \$704 |
| 5 | \$542 | 12 | \$731 |
| 6 | \$569 | L | \$716 |
| 7 | \$596 | | |

NOTES: Stacks 4-high.

! Ganging brackets work with armless Guest/Multi-purpose models only.

HISB6

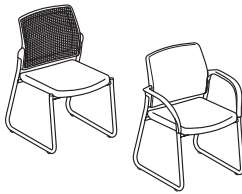

MULTI-PURPOSE

Sled Base

DIMENSIONS

| | | | |
|--------------|-----|---------------------------------|----------|
| Depth: | 23¾ | Seat to Floor Height: | 18⅝ |
| Width: | 25 | Usable Seat Depth: | 17⅝ |
| Height: | 33½ | Ship Weight (upholstered back): | 30 |
| Seat Depth: | 17⅝ | Ship Weight (mesh back): | 30 |
| Seat Width: | 18¾ | Cube (upholstered back): | 15.1 |
| Back Width: | 18¼ | Cube (mesh back): | 15.1 |
| Back Height: | 18⅝ | COM (upholstered back): | 1.5 |
| Arm Width: | 21½ | COM (mesh back): | 1.0 |
| | | Weight Rating: | 300 lbs. |

FABRIC PRICE CODES

| | | | |
|---|-------|----|-------|
| 1 | \$416 | 8 | \$623 |
| 2 | \$452 | 9 | \$650 |
| 3 | \$488 | 10 | \$677 |
| 4 | \$515 | 11 | \$704 |
| 5 | \$542 | 12 | \$731 |
| 6 | \$569 | L | \$716 |
| 7 | \$596 | | |

! Ganging brackets work with armless Guest/Multi-purpose models only.

HICS7

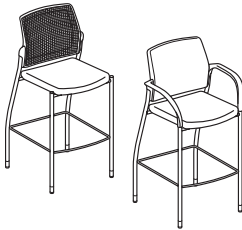

CAFÉ-HEIGHT STOOL

Four Legs

DIMENSIONS

| | | | |
|--------------|-----|---------------------------------|----------|
| Depth: | 23 | Seat to Floor Height: | 31 |
| Width: | 25 | Usable Seat Depth: | 17⅝ |
| Height: | 46½ | Ship Weight (upholstered back): | 37 |
| Seat Depth: | 17⅝ | Ship Weight (mesh back): | 37 |
| Seat Width: | 18¾ | Cube (upholstered back): | 21.8 |
| Back Width: | 18¼ | Cube (mesh back): | 21.8 |
| Back Height: | 18⅝ | COM (upholstered back): | 1.5 |
| Arm Width: | 21½ | COM (mesh back): | 1.0 |
| | | Weight Rating: | 300 lbs. |

FABRIC PRICE CODES

| | | | |
|---|-------|----|-------|
| 1 | \$526 | 8 | \$733 |
| 2 | \$562 | 9 | \$760 |
| 3 | \$598 | 10 | \$787 |
| 4 | \$625 | 11 | \$814 |
| 5 | \$652 | 12 | \$841 |
| 6 | \$679 | L | \$826 |
| 7 | \$706 | | |

! Ganging brackets work with armless Guest/Multi-purpose models only.

HIGB1



GANGING BRACKET

- For Armless Guest Chairs
- 24 per package

DIMENSIONS

| | |
|--------------|-----|
| Ship Weight: | 1 Ⓞ |
| Cube: | 0.1 |

LIST PRICE

\$77

HON Recommendation: HIGS6.F.H.IM.CU__T - List Price \$446

HOW TO SPECIFY

| | | | | | |
|-------------------------------------|--|---|---|--------------------------------------|--|
| Select Model Number HIGS6 | Select Arm Type F Fixed Arms (+ \$30) N Armless | Select Glide E Glide H Hard Caster S Soft Caster (+ \$20) <i>Casters available on HIGS6 only</i> | Select Back Type U Upholstered IM Black IF Fog IC Charcoal IH Chai IY Navy | Select Fabric See page 147 | Select Frame T Black BLCK Textured Black PLAT Textured Platinum Metallic PR8T Textured Titanium (+ \$35) |
| HIGS6. | F. | H. | IM. | CU10. | T |



HIGS6DF

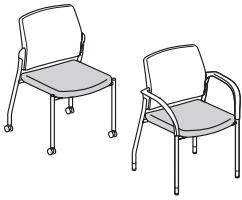

MULTI-PURPOSE

Dual Fabric
Four Legs

DIMENSIONS

| | | | |
|--------------|--------------------------------|---------------------------------|--------------------------------|
| Depth: | 21 ³ / ₄ | Arm Width: | 21 ¹ / ₂ |
| Width: | 25 | Seat to Floor Height: | 18 ³ / ₈ |
| Height: | 33 ¹ / ₂ | Usable Seat Depth: | 17 ³ / ₈ |
| Seat Depth: | 17 ³ / ₈ | Ship Weight (upholstered back): | 28 |
| Seat Width: | 18 ³ / ₄ | Cube (upholstered back): | 15.1 |
| Back Width: | 18 ¹ / ₄ | COM (back): | 0.75 |
| Back Height: | 18 ¹ / ₈ | COM (seat): | 0.75 |
| | | Weight Rating: | 300 lbs. |

FABRIC PRICE CODES

| | | |
|--------------------------------|--------------|--------------|
| 1 | \$491 | |
| <i>Add to Base Price Above</i> | | |
| | Back | Seat |
| 2 | \$18 | \$18 |
| 3 | \$36 | \$36 |
| 4 | \$50 | \$50 |
| 5 | \$63 | \$63 |
| 6 | \$77 | \$77 |
| 7 | \$90 | \$90 |
| 8 | \$104 | \$104 |
| 9 | \$117 | \$117 |
| 10 | \$131 | \$131 |
| 11 | \$144 | \$144 |
| 12 | \$158 | \$158 |
| L | \$150 | \$150 |

NOTES: Stacks 4-high.

! Ganging brackets work with armless Guest/Multi-purpose models only.

HISB6DF

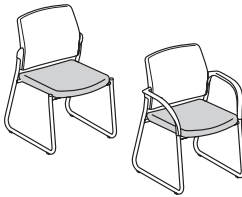

MULTI-PURPOSE

Dual Fabric
Sled Base

DIMENSIONS

| | | | |
|--------------|--------------------------------|---------------------------------|--------------------------------|
| Depth: | 23 ³ / ₄ | Arm Width: | 21 ¹ / ₂ |
| Width: | 25 | Seat to Floor Height: | 18 ³ / ₈ |
| Height: | 33 ¹ / ₂ | Usable Seat Depth: | 17 ³ / ₈ |
| Seat Depth: | 17 ³ / ₈ | Ship Weight (upholstered back): | 30 |
| Seat Width: | 18 ³ / ₄ | Cube (upholstered back): | 15.1 |
| Back Width: | 18 ¹ / ₄ | COM (back): | 0.75 |
| Back Height: | 18 ¹ / ₈ | COM (seat): | 0.75 |
| | | Weight Rating: | 300 lbs. |

FABRIC PRICE CODES

| | | |
|--------------------------------|--------------|--------------|
| 1 | \$491 | |
| <i>Add to Base Price Above</i> | | |
| | Back | Seat |
| 2 | \$18 | \$18 |
| 3 | \$36 | \$36 |
| 4 | \$50 | \$50 |
| 5 | \$63 | \$63 |
| 6 | \$77 | \$77 |
| 7 | \$90 | \$90 |
| 8 | \$104 | \$104 |
| 9 | \$117 | \$117 |
| 10 | \$131 | \$131 |
| 11 | \$144 | \$144 |
| 12 | \$158 | \$158 |
| L | \$150 | \$150 |

! Ganging brackets work with armless Guest/Multi-purpose models only.

HON Recommendation: HIGS6DF.F.H.U.CU__UR__.T - List Price \$557

HOW TO SPECIFY

| | | | | | | |
|---|--|---|--|---|---|---|
| Select Model Number HIGS6DF | Select Arm Type F Fixed Arms (+ \$30) N Armless | Select Glide E Glide H Hard Caster S Soft Caster (+ \$20) <i>Casters available on HIGS6DF only</i> | Select Back Type U Upholstered | Select Back Fabric See page 147 | Select Seat Fabric See page 147 | Select Frame T Black BLCK Textured Black PLAT Textured Platinum Metallic PR8T Textured Titanium (+ \$35) |
| HIGS6DF | F | H | U | CU10 | UR10 | T |



HICS7DF



CAFÉ-HEIGHT STOOL

Dual Fabric
Four Legs

DIMENSIONS

| | | | |
|--------------|-----|---------------------------------|----------|
| Depth: | 23 | Arm Width: | 21½ |
| Width: | 25 | Seat to Floor Height: | 31 |
| Height: | 46½ | Usable Seat Depth: | 17¾ |
| Seat Depth: | 17¾ | Ship Weight (upholstered back): | 37 |
| Seat Width: | 18¾ | Cube (upholstered back): | 21.8 |
| Back Width: | 18¼ | COM (back): | 0.75 |
| Back Height: | 18½ | COM (seat): | 0.75 |
| | | Weight Rating: | 300 lbs. |

FABRIC PRICE CODES

| | | | |
|--------------------------------|--------------|--------------|--------------|
| 1 | \$601 | | |
| <i>Add to Base Price Above</i> | | | |
| | | Back | Seat |
| 2 | \$18 | \$18 | \$18 |
| 3 | \$36 | \$36 | \$36 |
| 4 | \$50 | \$50 | \$50 |
| 5 | \$63 | \$63 | \$63 |
| 6 | \$77 | \$77 | \$77 |
| 7 | \$90 | \$90 | \$90 |
| 8 | \$104 | \$104 | \$104 |
| 9 | \$117 | \$117 | \$117 |
| 10 | \$131 | \$131 | \$131 |
| 11 | \$144 | \$144 | \$144 |
| 12 | \$158 | \$158 | \$158 |
| L | \$150 | \$150 | \$150 |

! Ganging brackets work with armless Guest/Multi-purpose models only.

HIGB1



GANGING BRACKET

- For Armless Guest Chairs
- 24 per package

DIMENSIONS

| | |
|--------------|-----|
| Ship Weight: | 1 Ⓢ |
| Cube: | 0.1 |

LIST PRICE

\$77

HON Recommendation: HICS7DF.F.H.U.CU__UR__.T - List Price \$667

HOW TO SPECIFY

| | | | | | | |
|-----------------------------------|--|--|--|--|--|---|
| <p>Select Model Number</p> | <p>Select Arm Type</p> <p>F Fixed Arms (+ \$30) N Armless</p> | <p>Select Glide</p> <p>E Glide H Hard Caster S Soft Caster (+ \$20) <i>Casters available on HIGS6DF only</i></p> | <p>Select Back Type</p> <p>U Upholstered</p> | <p>Select Back Fabric</p> <p>See page 147</p> | <p>Select Seat Fabric</p> <p>See page 147</p> | <p>Select Frame</p> <p>T Black BLCK Textured Black PLAT Textured Platinum Metallic PR8T Textured Titanium (+ \$35)</p> |
| H I C S 7 D F . | F . | H . | U . | C U 1 0 . | U R 1 0 . | T |

INSTIGATE™ Mesh Guest Chairs

OPEN MARKET



Icon Legend on page 17

HVL518



GUEST CHAIR

Leg Base
Arms
Stacks up to Four High

DIMENSIONS

| | | | |
|--------------|-----|-----------------------|---------------|
| Depth: | 22¼ | Arm Width: | 20¼ |
| Width: | 24 | Seat to Floor Height: | 17¾ |
| Height: | 35¾ | Usable Seat Depth: | 17½ |
| Seat Depth: | 17½ | Ship Weight: | 22.2 Ⓢ |
| Seat Width: | 18½ | Cube: | 3.2 |
| Back Width: | 17½ | Weight Rating: | 250 lbs. |
| Back Height: | 19 | | |

PRICE CODE

Fabric **\$192**

NOTES: Mesh back. Fixed arms. Double cross bar frame increases strength and durability. Stackable up to 4-high. Black fabric seat. **HON 5-Year Limited Warranty.**

HON Recommendation: HVL518.ES10 - List Price \$192

HVL508



GUEST CHAIR

Leg Base
Armless
Stacks up to Four High

DIMENSIONS

| | | | |
|-------------|-----|-----------------------|---------------|
| Depth: | 22¼ | Back Height: | 19 |
| Width: | 24 | Seat to Floor Height: | 18¾ |
| Height: | 35¾ | Usable Seat Depth: | 17½ |
| Seat Depth: | 17½ | Ship Weight: | 18.8 Ⓢ |
| Seat Width: | 18½ | Cube: | 3.1 |
| Back Width: | 17½ | Weight Rating: | 250 lbs. |

PRICE CODE

Fabric **\$172**

NOTES: Mesh back. Black fabric seat. Double cross bar frame increases strength and durability. Stackable up to 4-high. **HON 5-Year Limited Warranty.**

HON Recommendation: HVL508.ES10 - List Price \$172

HVL538



CAFÉ STOOL

Leg Base
Arms

DIMENSIONS

| | | | |
|--------------|-----|-----------------------|---------------|
| Depth: | 23¾ | Arm Width: | 20¼ |
| Width: | 20½ | Seat to Floor Height: | 33⅝ |
| Height: | 49¾ | Usable Seat Depth: | 17½ |
| Seat Depth: | 17½ | Ship Weight: | 44.5 Ⓢ |
| Seat Width: | 18½ | Cube: | 7.8 |
| Back Width: | 17½ | Weight Rating: | 250 lbs. |
| Back Height: | 19 | | |

PRICE CODE

Fabric
Per Carton **\$516**
Single Unit **\$258.00**

NOTES: Mesh back. Black fabric seat. Fixed arms. Ships two per carton. **HON 5-Year Limited Warranty.**

HON Recommendation: HVL538.ES10 - List Price \$516

HVL528



CAFÉ STOOL

Leg Base
Armless

DIMENSIONS

| | | | |
|-------------|-----|------------------------|---------------|
| Depth: | 23¾ | Back Height: | 19 |
| Width: | 20½ | Seat to Floor Height: | 33⅝ |
| Height: | 49¾ | Usable Seat Depth: | 17½ |
| Seat Depth: | 17½ | Ship Weight (armless): | 40.0 Ⓢ |
| Seat Width: | 18½ | Cube (armless): | 7.0 |
| Back Width: | 17½ | Weight Rating: | 250 lbs. |

PRICE CODE

Fabric
Per Carton **\$475**
Single Unit **\$237.50**

NOTES: Mesh back. Black fabric seat. Ships two per carton. **HON 5-Year Limited Warranty.**

Ⓢ Instigate™ HVL538 and HVL528 are ordered and shipped two (2) stools per carton. Pricing shown is per carton. Each set of two (one carton), must have the same fabric/frame color. Ordering 2 of any model will result in 2 cartons being shipped, giving you 4 stools.

HON Recommendation: HVL528.ES10 - List Price \$475

HOW TO SPECIFY

| | |
|---|---|
| <p>Select Model Number</p> <p>H V L 5 1 8 .</p> | <p>Select Fabric</p> <p>ES10 Black Fabric (only)</p> <p>E S 1 0</p> |
|---|---|

INVITATION® 2110 SERIES



Invitation Guest Chairs
and Table Connectors.

INVITATION® 2110 SERIES

Invitation brings the comforts of home into the workplace. Enjoy the simple pleasure of welcoming guests in arm chairs with integrated tables. Invitation guest chairs coordinate with Invitation lounge seating to make any space more comfortable and cohesive. Arrange in rows, groups or any configuration to suit your space or needs. The practical design and long-lasting comfort adds up to a stylish Invitation.



FEATURES

- Contoured back rest on guest chairs delivers ergonomic comfort.
- Floating back design enables easy cleaning.
- Guest chairs can be ganged together to create straight rows.
- Molded polymer seat shell increases comfort and durability.
- Solid hardwood in one of eight attractive finishes.
- Warranted for users up to 250 lbs.

INVITATION® 2110 Series Options

MODEL OPTIONS

H2111



Guest Chair

Leg Base, Arms

H2112



Guest Chair

Leg Base, Double
Rail Arms

AVAILABLE FINISHES

Invitation® 2110 Series Seating is available in 8 wood finishes.

WOOD FINISHES

Bourbon Cherry (H)

Cognac (COGN)

Harvest (C)

Mahogany (N)

Mocha (MOCH)

Natural Maple (D)

Pinnacle (PINC)

Shaker Cherry (F)

HON BRANDED FABRICS

GRADE 1

Attire
Centurion
Compass
Contourette Polyurethane
Dapper
Hamilton
Inertia
Optic

GRADE 2

Appoint Seating
Clyde
Dotty
Rush
Seed
Spin Seating
Whisper Vinyl

GRADE 3

In Season
Purl
Silvertex™ Vinyl

For a complete list of fabrics, including partnership fabrics, go to hon.com/fabricsandfinishes.

Reference Fabric Color Combinations on pages 20-24 for color codes and legend on page 21 for lead times. COM yardage shown is for Pattern Cut only. Contact Customer Service for Railroaded yardage requirements. For additional HON to Supply COM fabric grade pricing, go to honready.hon.com and click on the HON to Supply COM link.

 For Fire Code model, availability and ordering method, refer to pages 28-31. Available on select models, contact HON Customer Support for availability.



Icon Legend on page 17

INVITATION[®] 2110 Series

H2111



GUEST CHAIR

Leg Base
Arms

DIMENSIONS

| | | | |
|--------------|--------------------------------|-----------------------|--------------------------------|
| Depth: | 22 | Arm Width: | 18 ⁷ / ₈ |
| Width: | 23 ¹ / ₂ | Seat to Floor Height: | 18 ¹ / ₂ |
| Height: | 33 ³ / ₈ | Usable Seat Depth: | 17 |
| Seat Depth: | 17 | Ship Weight: | 24 |
| Seat Width: | 20 | Cube: | 15.0 |
| Back Width: | 21 | COM: | 1.5 |
| Back Height: | 16 | Weight Rating: | 250 lbs. |

FABRIC PRICE CODES

| | | | |
|---|-------|----|-------|
| 1 | \$574 | 8 | \$781 |
| 2 | \$610 | 9 | \$808 |
| 3 | \$646 | 10 | \$835 |
| 4 | \$673 | 11 | \$862 |
| 5 | \$700 | 12 | \$889 |
| 6 | \$727 | L | — |
| 7 | \$754 | | |

H2112



GUEST CHAIR

Leg Base
Double Rail Arms

DIMENSIONS

| | | | |
|--------------|--------------------------------|-----------------------|--------------------------------|
| Depth: | 22 | Arm Width: | 18 ⁷ / ₈ |
| Width: | 23 ¹ / ₂ | Seat to Floor Height: | 18 ¹ / ₂ |
| Height: | 33 ³ / ₈ | Usable Seat Depth: | 17 |
| Seat Depth: | 17 | Ship Weight: | 28 |
| Seat Width: | 20 | Cube: | 15.0 |
| Back Width: | 21 | COM: | 1.5 |
| Back Height: | 16 | Weight Rating: | 250 lbs. |

FABRIC PRICE CODES

| | | | |
|---|-------|----|-------|
| 1 | \$630 | 8 | \$837 |
| 2 | \$666 | 9 | \$864 |
| 3 | \$702 | 10 | \$891 |
| 4 | \$729 | 11 | \$918 |
| 5 | \$756 | 12 | \$945 |
| 6 | \$783 | L | — |
| 7 | \$810 | | |

HON Recommendation: H2111.MOCH.CU__ - List Price \$574

HOW TO SPECIFY

Select
Model Number

H 2 1 1 1 .

Select
Finish

See page 166

M O C H .

Select
Fabric

See page 166

C U 1 0 .

INVITATION® 2110 Series Connectors

GSA SIN 711-18



Icon Legend on page 17

H2141



CONNECTORS

for Model H2111
One connector per two chairs

DIMENSIONS

Depth: 13⁵/₁₆ Ship Weight: 2.0 **Ⓢ**
Width: 4⁷/₈ Cube: 0.3
Height: 1 Weight Rating: 300 lbs.

LIST PRICE

\$54

H2142

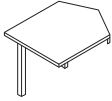

CORNER TABLE CONNECTOR

for Model H2111

DIMENSIONS

Depth: 28 Ship Weight: 25.5 **Ⓢ**
Width: 28 Cube: 2.6
Height: 17¹/₄ Weight Rating: 300 lbs.

LIST PRICE

\$482



! Customer or dealer must attach leg to table.

H2143

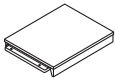

STRAIGHT TABLE CONNECTOR

for Model H2111

DIMENSIONS

Depth: 17¹/₈ Ship Weight: 16.5 **Ⓢ**
Width: 21 Cube: 1.5
Height: 17¹/₄ Weight Rating: 300 lbs.

LIST PRICE

\$348

H2144



CONNECTORS

for Model H2112
One connector per two chairs

DIMENSIONS

Depth: 13⁵/₁₆ Ship Weight: 2.0 **Ⓢ**
Width: 4⁷/₈ Cube: 0.3
Height: 1⁵/₁₆ Weight Rating: 300 lbs.

LIST PRICE

\$54

H2145



CORNER TABLE CONNECTOR

for Model H2112

DIMENSIONS

Depth: 28 Ship Weight: 25.5 **Ⓢ**
Width: 28 Cube: 2.6
Height: 17¹/₄ Weight Rating: 300 lbs.

LIST PRICE

\$482



! Customer or dealer must attach leg to table.

H2146

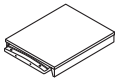

STRAIGHT TABLE CONNECTOR

for Model H2112

DIMENSIONS

Depth: 17¹/₈ Ship Weight: 16.5 **Ⓢ**
Width: 21 Cube: 1.5
Height: 17¹/₄ Weight Rating: 300 lbs.

LIST PRICE

\$348

HOW TO SPECIFY

| | |
|----------------------------|--|
| <p>Select Model Number</p> | <p>Select Finish</p> <p>See page 166</p> |
| <p>H 2 1 4 1 .</p> | <p>H</p> |

INVITATION® LOUNGE



Invitation Lounge.

INVITATION® LOUNGE

Welcome your guests in professional style. Enjoy the simple pleasure of relaxing on a sofa with a laptop or welcoming guests in plush arm chairs. The Invitation lounge collection combines gracefully sloping arms, tapered wood legs and the deep-foam comfort of separate seat cushions. Invitation lounge seating coordinates with Invitation 2110 Series guest seating and connecting tables to make any space more comfortable and cohesive.



FEATURES

- Transitional design blends contemporary lines and traditional details.
- Clean lines and refined scale easily adapt to any private office or lobby.
- Contemporary tapered legs are offered in Platinum metallic or Black finish.
- Impressive design and fine craftsmanship in an affordably priced lounge chair.
- Removable seat cushion is deeply padded for added comfort.
- Warranted for users up to 250 lbs.

INVITATION® Lounge Options

MODEL OPTIONS

HFAA01



Arm Chair

HFAL02

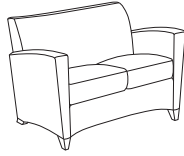

Love Seat

HFAS03

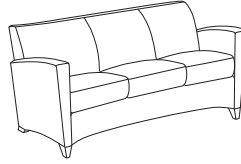

Sofa

LEG COLOR



| CODE | DESCRIPTION | PRICE |
|------|-------------|-------|
| T | Black | +\$0 |



| | | |
|----|-------------------|------|
| T1 | Platinum Metallic | +\$0 |
|----|-------------------|------|

CARTON

| CODE | DESCRIPTION | PRICE |
|------|-------------|-------|
| BC | Carton | +\$0 |

HON BRANDED FABRICS

GRADE 1

Attire
Centurion
Compass
Contourette Polyurethane
Dapper
Hamilton
Inertia
Optic

GRADE 2

Appoint Seating
Clyde
Dotty
Rush
Seed
Spin Seating
Whisper Vinyl

GRADE 3

In Season
Purl
Silvertex™ Vinyl

GRADE L

Denver Leather

For a complete list of fabrics, including partnership fabrics, go to hon.com/fabricsandfinishes.

Reference Fabric Color Combinations on pages 20-24 for color codes and legend on page 21 for lead times. For additional HON to Supply COM fabric grade pricing, go to honready.hon.com and click on the HON to Supply COM link.

⚠ For Fire Code model, availability and ordering method, refer to pages 28-31. Available on select models, contact HON Customer Support for availability.



HFAA01

ARM CHAIR



DIMENSIONS

| | | | |
|--------------|-----|-----------------------|----------|
| Depth: | 31½ | Arm Width: | 20 |
| Width: | 30 | Seat to Floor Height: | 18 |
| Height: | 34 | Usable Seat Depth: | 20 |
| Seat Depth: | 20 | Ship Weight: | 73 |
| Seat Width: | 20 | Cube: | 27.0 |
| Back Width: | 20 | COM: | 5.0 |
| Back Height: | 16 | Weight Rating: | 250 lbs. |

FABRIC PRICE CODES

| | | | |
|---|--------|----|--------|
| 1 | \$1670 | 8 | \$2360 |
| 2 | \$1790 | 9 | \$2450 |
| 3 | \$1910 | 10 | \$2540 |
| 4 | \$2000 | 11 | \$2630 |
| 5 | \$2090 | 12 | \$2720 |
| 6 | \$2180 | L | \$2670 |
| 7 | \$2270 | | |

HFAL02

LOVE SEAT

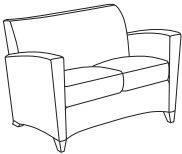

DIMENSIONS

| | | | |
|--------------|-----|-----------------------|----------|
| Depth: | 31¾ | Arm Width: | 40¼ |
| Width: | 50¼ | Seat to Floor Height: | 18 |
| Height: | 34¼ | Usable Seat Depth: | 20 |
| Seat Depth: | 20 | Ship Weight: | 112 |
| Seat Width: | 40¼ | Cube: | 55.7 |
| Back Width: | 40¼ | COM: | 6.5 |
| Back Height: | 16 | Weight Rating: | 250 lbs. |

FABRIC PRICE CODES

| | | | |
|---|--------|----|--------|
| 1 | \$2295 | 8 | \$3192 |
| 2 | \$2451 | 9 | \$3309 |
| 3 | \$2607 | 10 | \$3426 |
| 4 | \$2724 | 11 | \$3543 |
| 5 | \$2841 | 12 | \$3660 |
| 6 | \$2958 | L | \$3595 |
| 7 | \$3075 | | |

HFAS03

SOFA

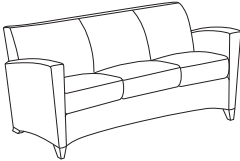

DIMENSIONS

| | | | |
|--------------|-----|-----------------------|----------|
| Depth: | 32 | Arm Width: | 60½ |
| Width: | 70½ | Seat to Floor Height: | 18 |
| Height: | 34½ | Usable Seat Depth: | 20 |
| Seat Depth: | 20 | Ship Weight: | 140 |
| Seat Width: | 60½ | Cube: | 72.0 |
| Back Width: | 60½ | COM: | 8.5 |
| Back Height: | 16 | Weight Rating: | 250 lbs. |

FABRIC PRICE CODES

| | | | |
|---|--------|----|--------|
| 1 | \$2920 | 8 | \$4093 |
| 2 | \$3124 | 9 | \$4246 |
| 3 | \$3328 | 10 | \$4399 |
| 4 | \$3481 | 11 | \$4552 |
| 5 | \$3634 | 12 | \$4705 |
| 6 | \$3787 | L | \$4620 |
| 7 | \$3940 | | |

HON Recommendation: HFAA01.PNS__T.BC - List Price \$1790

HOW TO SPECIFY

| | | | |
|---|---|---|---|
| <p>Select Model Number</p> <p>HFAA01</p> | <p>Select Fabric</p> <p>See page 170</p> <p>PNS007</p> | <p>Select Leg Color</p> <p>T Black T1 Platinum Metallic</p> <p>T</p> | <p>Select Carton Option</p> <p>BC Carton</p> <p>BC</p> |
|---|---|---|---|



Lota Mesh Back Work and Side Chair with Voi® desks.

LOTA®

If you're looking for all-day comfort without breaking the bank, look no further than Lota. This mesh back family of task and guest chairs offer advanced features for customizable comfort that make it an upscale choice at an affordable price. Lota's control mechanism uses your own weight to provide perfect balance while reclining, and the pivoting arms put upper body support right where it's needed. If you sit for hours on end, put yourself in more control over your comfort.



FEATURES

- Weight-activated control responds naturally to your body's movements without any adjustments.
- 3-way arms adjust to various heights, depths and pivot positions.
- Multi-purpose chairs feature black arms and base.
- One-touch seat height adjustment easily moves the seat up and down.
- Tilt tension controls the rate and ease of recline.
- Tilt lock allows the user to lock out the tilt function.
- 360-degree swivel provides freedom of movement in any direction.
- Polished Aluminum arms and base available on Models H2283 and H2284.
- Models H2281 and H2283 available in black, charcoal and navy fabrics.
- Models H2282 and H2284 available in hundreds of HON fabric options.
- H2285 available in black fabric only.
- Multi-purpose chairs stack four high on the floor.
- Warranted for users up to 275 lbs.

MODEL OPTIONS

H2281



Mid-Back Work (Mesh Back)

Pneumatic, Tilt Lock, Weight Activated Control, Height, Depth, Pivot Adjustable Arms, Black Arms and Base

H2283



Mid-Back Work (Mesh Back)

Pneumatic, Tilt Lock, Weight Activated Control, Height, Depth, Pivot Adjustable Arms, Polished Aluminum Arms, Base, and Back Upright

H2285



Multi-Purpose (Mesh Back)

4-Leg Stacking Frame, Fixed Arms

H2282



Mid-Back Work (Mesh Back)

Pneumatic, Tilt Lock, Weight Activated Control, Height, Depth, Pivot Adjustable Arms, Black Arms and Base

H2284



Mid-Back Work (Mesh Back)

Pneumatic, Tilt Lock, Weight Activated Control, Height, Depth, Pivot Adjustable Arms, Polished Aluminum Arms, Base, and Back Upright

CASTERS



| CODE | DESCRIPTION | PRICE |
|------|-------------|-------|
| H | Hard Caster | + \$0 |



| | | |
|---|-------------|--------|
| S | Soft Caster | + \$30 |
|---|-------------|--------|

**Casters available on H2282 and H2284 only*

FRAME

| CODE | DESCRIPTION | PRICE |
|------|-------------|-------|
| T | Black | + \$0 |

**Available on H2281 and H2282 only*

| | | |
|----|-------------------|-------|
| PA | Polished Aluminum | + \$0 |
|----|-------------------|-------|

**Available on H2283 and H2284 only*

LOTA[®] Fabric Options

LOTA[®] MID-BACK WORK H2281/H2283

GRADE 1

Black Fabric
Charcoal Fabric
Navy Fabric

GRADE 2

GRADE 3

For a complete list of fabrics, including partnership fabrics, go to hon.com/fabricsandfinishes.

Reference Fabric Color Combinations on pages 20-24 for color codes and legend on page 21 for lead times.

 For Fire Code model, availability and ordering method, refer to pages 28-31. Available on select models, contact HON Customer Support for availability.

LOTA[®] MID-BACK WORK H2282/H2284 HON BRANDED FABRICS

GRADE 1

Attire
Centurion
Compass
Contourette Polyurethane
Dapper
Hamilton
Inertia
Optic

GRADE 2

Appoint Seating
Clyde
Dotty
Rush
Seed
Spin Seating
Whisper Vinyl

GRADE 3

In Season
Purl
Silvertex[™] Vinyl

For a complete list of fabrics, including partnership fabrics, go to hon.com/fabricsandfinishes.

Reference Fabric Color Combinations on pages 20-24 for color codes and legend on page 21 for lead times. For additional HON to Supply COM fabric grade pricing, go to honready.hon.com and click on the HON to Supply COM link.

 For Fire Code model, availability and ordering method, refer to pages 28-31. Available on select models, contact HON Customer Support for availability.

MULTI-PURPOSE H2285 HON BRANDED FABRICS

GRADE 1

Black Fabric

GRADE 2

GRADE 3

For a complete list of fabrics, including partnership fabrics, go to hon.com/fabricsandfinishes.

Reference Fabric Color Combinations on pages 20-24 for color codes and legend on page 21 for lead times.

 For Fire Code model, availability and ordering method, refer to pages 28-31. Available on select models, contact HON Customer Support for availability.



H2281



MID-BACK WORK CHAIR

Mesh Back
 Pneumatic
 Tilt Lock
 Weight Activated Control
 Height, Depth, Pivot Adjustable
 Arms
 Black Arms and Base

DIMENSIONS

Depth: 27¾
 Width: 26¾
 Height: 43½
 Seat Depth: 17¼
 Seat Width: 19½
 Back Width: 17¾
 Back Height: 23½
 Arm Width: 20⅞
 Seat to Floor Height: 17⅞-21⅞
 Usable Seat Depth: 17¼
 Ship Weight: 50 **Ⓢ**
 Cube: 6.5
 Weight Rating: 250 lbs.

LIST PRICE

\$575

Functions: **A, E, F, L, Q**
 (Function Key on pages 18-19)

! Black Mesh back only.

H2283



MID-BACK WORK CHAIR

Mesh Back
 Pneumatic
 Tilt Lock
 Weight Activated Control
 Height, Depth, Pivot Adjustable
 Arms
 Polished Aluminum Arms, Base,
 and Back Upright

DIMENSIONS

Depth: 27¾
 Width: 26¾
 Height: 43⅝
 Seat Depth: 17¼
 Seat Width: 19½
 Back Width: 17¾
 Back Height: 23½
 Arm Width: 20¼
 Seat to Floor Height: 17-21
 Usable Seat Depth: 17¼
 Ship Weight: 53 **Ⓢ**
 Cube: 6.5
 Weight Rating: 250 lbs.

LIST PRICE

\$706

Functions: **A, E, F, L, Q**
 (Function Key on pages 18-19)

! Black Mesh back only.

HON Recommendation: H2281.VA10.T - List Price \$575

HOW TO SPECIFY

| | | |
|---|---|---|
| <p>Select Model Number</p> <p>H 2 2 8 1 . H 2 2 8 3 .</p> | <p>Select Fabric</p> <p>VA10 Black Fabric VA19 Charcoal Fabric VA90 Navy Fabric</p> <p>V A 1 0 . V A 1 0 .</p> | <p>Select Frame</p> <p>T Black (available on model H2281 only) PA Polished Aluminum (available on model H2283 only)</p> <p>T P A</p> |
|---|---|---|



H2282



MID-BACK WORK CHAIR

Mesh Back
 Pneumatic
 Tilt Lock
 Weight Activated Control
 Height, Depth, Pivot Adjustable
 Arms
 Black Arms and Base

Functions: **A, E, F, L, Q**
 (Function Key on pages 18-19)

! Black Mesh back only.

DIMENSIONS

Depth: 27¾
 Width: 26¾
 Height: 43½
 Seat Depth: 17¼
 Seat Width: 19½
 Back Width: 17¾
 Back Height: 23½
 Arm Width: 20⅝
 Seat to Floor Height: 17⅝-21⅝
 Usable Seat Depth: 17¼
 Ship Weight: 50 Ⓢ
 Cube: 6.5
 Weight Rating: 250 lbs.

FABRIC PRICE CODES

| | | | |
|---|-------|----|-------|
| 1 | \$632 | 8 | \$770 |
| 2 | \$656 | 9 | \$788 |
| 3 | \$680 | 10 | \$806 |
| 4 | \$698 | 11 | \$824 |
| 5 | \$716 | 12 | \$842 |
| 6 | \$734 | L | — |
| 7 | \$752 | | |

H2284



MID-BACK WORK CHAIR

Mesh Back
 Pneumatic
 Tilt Lock
 Weight Activated Control
 Height, Depth, Pivot Adjustable
 Arms
 Polished Aluminum Arms, Base,
 and Back Upright

Functions: **A, E, F, L, Q**
 (Function Key on pages 18-19)

! Black Mesh back only.

DIMENSIONS

Depth: 27¾
 Width: 26¾
 Height: 43⅝
 Seat Depth: 17¼
 Seat Width: 19½
 Back Width: 17¾
 Back Height: 23½
 Arm Width: 20⅝
 Seat to Floor Height: 17-21
 Usable Seat Depth: 17¼
 Ship Weight: 53 Ⓢ
 Cube: 6.5
 Weight Rating: 250 lbs.

FABRIC PRICE CODES

| | | | |
|---|-------|----|-------|
| 1 | \$761 | 8 | \$899 |
| 2 | \$785 | 9 | \$917 |
| 3 | \$809 | 10 | \$935 |
| 4 | \$827 | 11 | \$953 |
| 5 | \$845 | 12 | \$971 |
| 6 | \$863 | L | — |
| 7 | \$881 | | |

HON Recommendation: H2282.H.CU__T - List Price \$632

HOW TO SPECIFY

| Select Model Number | Select Caster | Select Fabric | Select Frame |
|---------------------|---|---------------|---|
| H 2 2 8 2 . | H Hard Caster S Soft Caster (+ \$30) | See page 174 | T Black (available on model H2282 only) PA Polished Aluminum (available on model H2284 only) |
| H 2 2 8 4 . | H . | C U 1 0 . | T |
| | H . | C U 1 0 . | PA |



H2285



MULTI-PURPOSE CHAIR

Mesh Back
4-Leg Stacking Frame
Fixed Arms

DIMENSIONS

| | | | |
|--------------|-----|-----------------------|-------------|
| Depth: | 24¾ | Arm Width: | 19⅞ |
| Width: | 23 | Seat to Floor Height: | 19⅞ |
| Height: | 34½ | Usable Seat Depth: | 17¾ |
| Seat Depth: | 17¾ | Ship Weight: | 20 Ⓢ |
| Seat Width: | 18⅞ | Cube: | 2.8 |
| Back Width: | 17⅞ | Weight Rating: | 250 lbs. |
| Back Height: | 17¾ | | |

LIST PRICE

\$313

NOTES: Casters and glides ship packaged together for customer's assembly choice. Stacks 4-high on floor.

! Available in VA10 Black fabric seat and Black frame only. Black Mesh back only.

HOW TO SPECIFY

| | | |
|--|---|--|
| <p>Select Model Number</p> <p>H 2 2 8 5 .</p> | <p>Select Fabric</p> <p>VA10 Black Fabric</p> <p>V A 1 0 .</p> | <p>Select Frame</p> <p>T Black</p> <p>T</p> |
|--|---|--|

MOTIVATE® CHAIRS



Motivate 4-Leg Stacking
Chairs and Table.

MOTIVATE® CHAIRS

A presentation in the morning. A training session in the afternoon. Today's multi-purpose spaces are in constant flux, and need an adaptable seating solution that delivers instant comfort for all, while easily moving around to support various activities. Motivate task chairs, stacking/nesting chairs and guest chairs create a streamlined collection of seating that intuitively responds to your body's natural movements and curves. Whether sitting for five minutes or five hours, when you Motivate your team you put everyone at ease.



FEATURES

- Choose plastic, upholstered or ilira®-stretch mesh back.
- Easily move chairs around the space for quick rearrangement.
- HMN1 nesting/stacking chairs stack four high on the floor.
- HMS1 sled base chairs stack 12 high on the floor or 40 high on a cart.
- HMS2 sled base chairs stack six high on the floor.
- Dynamic flex-zone motion in seat and back provides balance and lumbar support.
- Model HMT5 task stool features an adjustable footring.
- Plastic shell is available in 13 colors.
- Available in hundreds of quality HON fabrics.
- Warranted for users up to 300 lbs.

TASK CHAIR FEATURES

- One-touch seat height adjustment easily moves the seat up and down.
- 360-degree swivel provides freedom of movement in any direction.
- Warranted for users up to 300 lbs.

MOTIVATE® Task Chair Options

MODEL OPTIONS

HMT1



Flex-back

Upholstered Seat,
Pneumatic, Swivel

HMT5



Flex-back

Upholstered Seat,
Pneumatic, Swivel
Adjustable Footresting

ARM STYLE

| CODE | DESCRIPTION | PRICE |
|----------|-----------------|--------------|
| N | Armless | +\$0 |
| A | Adjustable Arms | +\$70 |



CASTERS

| CODE | DESCRIPTION | PRICE |
|----------|-------------|--------------|
| H | Hard Caster | +\$0 |
| S | Soft Caster | +\$30 |



BACK STYLE

| CODE | DESCRIPTION | PRICE |
|------|-------------|-------|
|------|-------------|-------|

Plastic/Upholstered Options:



| | | |
|-----------|---------------|-------------|
| PS | Plastic Shell | +\$0 |
|-----------|---------------|-------------|



| | | |
|-----------|-------------|--------------|
| PB | Upholstered | +\$70 |
|-----------|-------------|--------------|

ilira® - stretch M4 Options:



| | | |
|-----------|----------|--------------|
| IM | Black | +\$80 |
| IF | Fox | +\$80 |
| IC | Charcoal | +\$80 |
| IH | Chai | +\$80 |
| IY | Navy | +\$80 |

PLASTIC SHELL COLOR CODES (no upcharge):

Tangelo - **RG**
Regatta - **RE**
Lava - **LA**

Cherry - **CR**
Mulberry - **MB**
Onyx - **ON**

Lime - **LM**
Loft - **LO**
White - **WT**

Calypso - **CP**
Platinum - **PT**

Surf - **BU**
Shadow - **SD**

BASE



| CODE | DESCRIPTION | PRICE |
|-----------|---------------|-------------|
| SB | Standard Base | +\$0 |

FRAME COLOR

| CODE | DESCRIPTION | PRICE |
|----------|-------------|-------------|
| T | Black | +\$0 |

MOTIVATE[®]

Task Chair Fabric Options

HON BRANDED FABRICS

GRADE 1

Attire
Centurion
Compass
Contourette Polyurethane
Dapper
Hamilton
Inertia
Optic

GRADE 2

Appoint Seating
Clyde
Dotty
Rush
Seed
Spin Seating
Whisper Vinyl

GRADE 3

In Season
Purl
Silvertex™ Vinyl

GRADE L

Denver Leather

For a complete list of fabrics, including partnership fabrics, go to hon.com/fabricsandfinishes.

Reference Fabric Color Combinations on pages 20-24 for color codes and legend on page 21 for lead times.

 For Fire Code model, availability and ordering method, refer to pages 28-31. Available on select models, contact HON Customer Support for availability.



Icon Legend on page 17

MOTIVATE® Task Chairs

HMT1

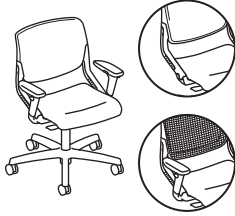

TASK CHAIR

Flex-back
Upholstered Seat
Pneumatic
Swivel

DIMENSIONS

| | | | |
|--------------|--------|----------------------------------|-------------|
| Depth: | 27½ | Seat to Floor Height: | 17-22½ |
| Width: | 27½ | Usable Seat Depth: | 18 |
| Height: | 37½ | Ship Weight (upholstered back): | 39 Ⓢ |
| Seat Depth: | 18 | Ship Weight (plastic/mesh back): | 38 Ⓢ |
| Seat Width: | 17½ | Cube (upholstered back): | 10.0 |
| Back Width: | 19½ | Cube (plastic/mesh back): | 10.0 |
| Back Height: | 17¾ | COM (upholstered back): | 1.5 |
| Arm Width: | 18½-20 | COM (plastic/mesh back): | 1.0 |
| | | Weight Rating: | 300 lbs. |

FABRIC PRICE CODES

| | | | |
|----------|--------------|-----------|--------------|
| 1 | \$422 | 8 | \$629 |
| 2 | \$458 | 9 | \$656 |
| 3 | \$494 | 10 | \$683 |
| 4 | \$521 | 11 | \$710 |
| 5 | \$548 | 12 | \$737 |
| 6 | \$575 | L | \$722 |
| 7 | \$602 | | |

! When a Plastic Shell (PS) or Upholstered Back (PB) option is chosen, you must select a shell color. If the mesh back option is chosen, the shell color is not specified. CA Technical Bulletin 133 compliant shells available in LA-Lava ONLY, ordering instructions below.

HMT5

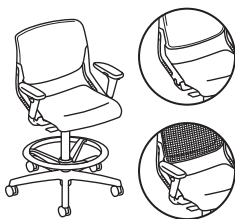

TASK STOOL

Flex-back
Upholstered Seat
Pneumatic
Swivel Adjustable Footring

DIMENSIONS

| | | | |
|--------------|--------|----------------------------------|-------------|
| Depth: | 28¼ | Seat to Floor Height: | 22½-32½ |
| Width: | 28¼ | Usable Seat Depth: | 18 |
| Height: | 50½ | Ship Weight (upholstered back): | 44 Ⓢ |
| Seat Depth: | 18 | Ship Weight (plastic/mesh back): | 43 Ⓢ |
| Seat Width: | 17½ | Cube (upholstered back): | 10.0 |
| Back Width: | 19½ | Cube (plastic/mesh back): | 10.0 |
| Back Height: | 17¾ | COM (upholstered back): | 1.5 |
| Arm Width: | 18½-20 | COM (plastic/mesh back): | 1.0 |
| | | Weight Rating: | 300 lbs. |

FABRIC PRICE CODES

| | | | |
|----------|--------------|-----------|--------------|
| 1 | \$480 | 8 | \$687 |
| 2 | \$516 | 9 | \$714 |
| 3 | \$552 | 10 | \$741 |
| 4 | \$579 | 11 | \$768 |
| 5 | \$606 | 12 | \$795 |
| 6 | \$633 | L | \$780 |
| 7 | \$660 | | |

NOTES: Stool model has adjustable footring.

! When a Plastic Shell (PS) or Upholstered Back (PB) option is chosen, you must select a shell color. If the mesh back option is chosen, the shell color is not specified. CA Technical Bulletin 133 compliant shells available in LA-Lava ONLY, ordering instructions below.

HON Recommendation: HMT1.A.H.IM.CU__SB.T - List Price \$572

HOW TO SPECIFY

| Select Model Number | Select Arm Type | Select Caster | Select Back Type/Color | Select Fabric | Select Base | Select Frame |
|---------------------|---|---|--|---------------|-------------------------|----------------|
| | A Adjustable Arms (+ \$70) N Armless | H Hard Caster S Soft Caster (+ \$30) | PS Plastic Shell PB Upholstered (+ \$70) If PS or PB options are chosen, select shell color. Plastic Shell Colors RG Tangelo LO Loft CR Cherry PT Platinum LM Lime SD Shadow CP Calypso LA Lava BU Surf ON Onyx RE Regatta WT White MB Mulberry ilira®-stretch M4 options (+ \$80) IM Black IH Chai IF Fog IY Navy IC Charcoal | See page 180 | SB Standard Base | T Black |
| HMT1 | A | H | IM | CU10 | SB | T |
| HMT1 | A | H | PSLA | CU10 | SB | T |

MOTIVATE® High-Density Sled Base Chair Options

MODEL OPTIONS

HMS1



High-Density Stacker

Sled Leg Base

HMS2



High-Density Stacker

Upholstered Seat, Sled Leg Base

ARM STYLE

| CODE | DESCRIPTION | PRICE |
|----------|-------------|--------------|
| F | Fixed Arms | +\$30 |
| N | Armless | +\$0 |

FRAME

| CODE | DESCRIPTION | PRICE |
|-------------|----------------------------|-------------|
| Y | Chrome | +\$0 |
| BLCK | Textured Black | +\$0 |
| PLAT | Textured Platinum Metallic | +\$0 |

| PLASTIC SHELL COLOR CODES (no upcharge): | Tangelo - RG | Cherry - CR | Lime - LM | Calypso - CP | Surf - BU |
|--|---------------------|----------------------|-------------------|----------------------|--------------------|
| | Regatta - RE | Mulberry - MB | Loft - LO | Platinum - PT | Shadow - SD |
| | Lava - LA | Onyx - ON | White - WT | | |

ⓘ CA Technical Bulletin 133 compliant shells available in all 13 shell colors (no upcharge).

HON BRANDED FABRICS

GRADE 1

Attire
Centurion
Compass
Contourette Polyurethane
Dapper
Hamilton
Inertia
Optic

GRADE 2

Appoint Seating
Clyde
Dotty
Rush
Seed
Spin Seating
Whisper Vinyl

GRADE 3

In Season
Purl
Silvertext™ Vinyl

GRADE L

Denver Leather

For a complete list of fabrics, including partnership fabrics, go to hon.com/fabricsandfinishes.

Reference Fabric Color Combinations on pages 20-24 for color codes and legend on page 21 for lead times.

🔥 For Fire Code model, availability and ordering method, refer to pages 28-31. Available on select models, contact HON Customer Support for availability.



MOTIVATE® High-Density Sled Base Chairs

HMS1

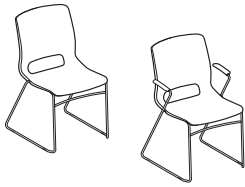

HIGH-DENSITY STACKER

Sled Leg Base

DIMENSIONS

| | | | |
|--------------|--------------------------------|-----------------------|--------------------------------|
| Depth: | 23 | Arm Width: | 18 ⁷ / ₈ |
| Width: | 21 | Seat to Floor Height: | 17 ³ / ₄ |
| Height: | 32 ¹ / ₄ | Usable Seat Depth: | 18 ³ / ₄ |
| Seat Depth: | 18 ³ / ₄ | Ship Weight: | 72 |
| Seat Width: | 17 ³ / ₄ | Cube: | 15.2 |
| Back Width: | 17 ¹ / ₄ | Weight Rating: | 300 lbs. |
| Back Height: | 18 | | |

LIST PRICE PER CARTON

\$781
(reference single unit @ \$195.25)

NOTES: HMS1 shells are CA Technical Bulletin 133 compliant (no upcharge). HMS1 Sled Base chairs stack 12-high on the floor, or 40-high on the chair cart model HMSCART. Field installed glides snap-on using existing locations on the sled base frames.

ⓘ HMS1 is not available in FC. Ganging Chair Glides are designed for use on armless models of the Motivate® High-Density Sled Base Chairs only. Not for use on models specified with arms.

HMS2

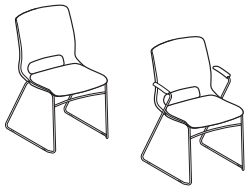

HIGH-DENSITY STACKER

Upholstered Seat
Sled Leg Base

DIMENSIONS

| | | | |
|--------------|--------------------------------|-----------------------|--------------------------------|
| Depth: | 23 | Arm Width: | 18 ⁷ / ₈ |
| Width: | 21 | Seat to Floor Height: | 18 ³ / ₄ |
| Height: | 32 ¹ / ₄ | Usable Seat Depth: | 18 ³ / ₄ |
| Seat Depth: | 18 ³ / ₄ | Ship Weight: | 80 |
| Seat Width: | 17 ³ / ₄ | Cube: | 15.2 |
| Back Width: | 17 ¹ / ₄ | COM (per 4 pack): | 1.6 |
| Back Height: | 17 ¹ / ₂ | Weight Rating: | 300 lbs. |

FABRIC PRICE CODES

| | | | |
|----------|---------------|-----------|---------------|
| 1 | \$1033 | 8 | \$1171 |
| 2 | \$1057 | 9 | \$1189 |
| 3 | \$1081 | 10 | \$1207 |
| 4 | \$1099 | 11 | \$1225 |
| 5 | \$1117 | 12 | \$1243 |
| 6 | \$1135 | L | \$1233 |
| 7 | \$1153 | | |

NOTES: HMS2 Sled Base chairs stack 6-high on the floor. Field installed glides snap-on using existing locations on the sled base frames.

ⓘ Ganging Chair Glides are designed for use on armless models of the Motivate® High-Density Sled Base Chairs only. Not for use on models specified with arms. Upholstered seat model HMS2 is not designed to be stacked on the HMSCART.

⊕ Motivate® Sled Base Chairs are ordered and shipped four (4) chairs per carton. Pricing shown is per carton. Each set of four chairs (one carton), must have the same shell/frame color combination. Ordering 2 of Model HMS1, HMS2 will result in 2 cartons being shipped, giving you 8 chairs.

HMSCART

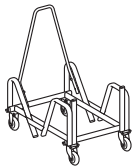

CART FOR HMS1 STACKING CHAIRS

DIMENSIONS

| | | | |
|---------|--------------------------------|--------------|-----|
| Depth: | 34 ¹ / ₄ | Ship Weight: | 40 |
| Width: | 21 ³ / ₈ | Cube: | 7.8 |
| Height: | 36 ³ / ₈ | | |

LIST PRICE

\$448

NOTES: Holds up to 40 Stacking Chairs.

HON Recommendation: HMS1.N.ON.Y - List Price \$781

HOW TO SPECIFY

| | | | | |
|---|---|---|---|---|
| <p>Select Model Number</p> <p>HMS1 .</p> <p>HMS2 .</p> | <p>Select Arm Type</p> <p>F Fixed Arms (+ \$30 per chair)</p> <p>N Armless</p> <p>N .</p> <p>N .</p> | <p>Select Shell Color</p> <p>RG Tangelo LO Loft</p> <p>CR Cherry PT Platinum</p> <p>LM Lime SD Shadow</p> <p>CP Calypso LA Lava</p> <p>BU Surf ON Onyx</p> <p>RE Regatta WT White</p> <p>MB Mulberry</p> <p>ON .</p> <p>ON .</p> | <p>Select Fabric</p> <p>See page 182</p> <p><i>Not specified for HMS1 models</i></p> <p>CU10 .</p> | <p>Select Frame</p> <p>Y Chrome</p> <p>BLCK Textured Black</p> <p>PLAT Textured Platinum</p> <p>Metallic</p> <p>BLCK</p> <p>BLCK</p> |
|---|---|---|---|---|

MOTIVATE® High-Density Sled Base Chairs

OPEN MARKET



Icon Legend on page 17

HMSGLD



GLIDES FOR MOTIVATE® HIGH-DENSITY STACKER

- Kit includes 48 glides for 12 chairs
- Field installed
- Snap-on using existing locations on frames

DIMENSIONS

Ship Weight: 1 Ⓢ
Cube: 0.2

LIST PRICE

\$61

HMSFLTGLD



FELT GLIDES FOR MOTIVATE® HIGH-DENSITY STACKER

- Kit includes 48 glides for 12 chairs
- Field installed
- Snap-on using existing locations on frames

DIMENSIONS

Ship Weight: 1 Ⓢ
Cube: 0.2

LIST PRICE

\$159

HMSSTLGLD



STEEL GLIDES FOR MOTIVATE® HIGH-DENSITY STACKER

- Kit includes 48 glides for 12 chairs
- Field installed
- Snap-on using existing locations on frames

DIMENSIONS

Ship Weight: 1 Ⓢ
Cube: 0.2

LIST PRICE

\$159

HMSGANG

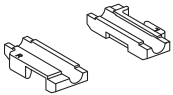

GANGING CONNECTORS FOR MOTIVATE® HIGH- DENSITY STACKER

- 48 ganging connectors
- Requires 4 connectors per ganging connection
- For use on HMS1.N and HMS2.N only (armless models)
- Field installed
- Snap-on using existing locations on frames

DIMENSIONS

Ship Weight: 1 Ⓢ
Cube: 0.2

LIST PRICE

\$116

HOW TO SPECIFY

Select
Model Number

H M S G L D

MOTIVATE® 4-Leg Chair Options

MODEL OPTIONS

HMG1



Stack Chair

Four Legs, Set of 2

HMG2



Stack Chair

Four Legs, Upholstered
Seat, Set of 2

HMG5



Café-Height Stool

Four Legs

HMG7



Café-Height Stool

Four Legs, Upholstered
Seat

ARM STYLE

| CODE | DESCRIPTION | PRICE |
|----------|-------------|--------------|
| F | Fixed Arms | +\$30 |
| N | Armless | +\$0 |



CASTERS/ GLIDES



| CODE | DESCRIPTION | PRICE |
|---|----------------------|--------------|
| H | Hard Caster | +\$0 |
| S | Soft Caster | +\$20 |
| <i>*Casters only available on HMG1 and HMG2</i> | | |
| E | Standard Nylon Glide | +\$0 |
| F | Felt Glide | +\$30 |
| R | Rubber Glide | +\$30 |
| T | Steel Glide | +\$30 |

FRAME

| CODE | DESCRIPTION | PRICE |
|-------------|----------------------------|-------------|
| BLCK | Textured Black | +\$0 |
| PLAT | Textured Platinum Metallic | +\$0 |

PLASTIC SHELL COLOR CODES (no upcharge):
 Tangelo - **RG** Cherry - **CR** Lime - **LM** Calypso - **CP** Surf - **BU**
 Regatta - **RE** Mulberry - **MB** Loft - **LO** Platinum - **PT** Shadow - **SD**
 Lava - **LA** Onyx - **ON** White - **WT**

❗ CA Technical Bulletin 133 compliant shells available in all 13 shell colors (no upcharge).

MOTIVATE®

4-Leg Chair Fabric Options

HON BRANDED FABRICS

GRADE 1

Attire
Centurion
Compass
Contourette Polyurethane
Dapper
Hamilton
Inertia
Optic

GRADE 2

Appoint Seating
Clyde
Dotty
Rush
Seed
Spin Seating
Whisper Vinyl

GRADE 3

In Season
Purl
Silvertex™ Vinyl

GRADE L

Denver Leather

For a complete list of fabrics, including partnership fabrics, go to hon.com/fabricsandfinishes.

Reference Fabric Color Combinations on pages 20-24 for color codes and legend on page 21 for lead times.

 For Fire Code model, availability and ordering method, refer to pages 28-31. Available on select models, contact HON Customer Support for availability.



Icon Legend on page 17

MOTIVATE® 4-Leg Chairs

HMG1

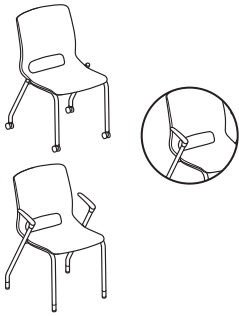

STACK CHAIR

Four Legs
Set of 2

DIMENSIONS

| | | | |
|--------------|-----|-----------------------|----------|
| Depth: | 23 | Arm Width: | 18 |
| Width: | 21 | Seat to Floor Height: | 17¾ |
| Height: | 32¼ | Usable Seat Depth: | 18¼ |
| Seat Depth: | 18¼ | Ship Weight: | 38 |
| Seat Width: | 17¾ | Cube: | 13.0 |
| Back Width: | 17¼ | Weight Rating: | 300 lbs. |
| Back Height: | 18 | | |

LIST PRICE PER CARTON

\$528
(reference single unit @
\$264.00

NOTES: HMG1 shells are CA Technical Bulletin 133 compliant (no upcharge). 4-Leg chairs stack 6-high on the floor.

HMG2

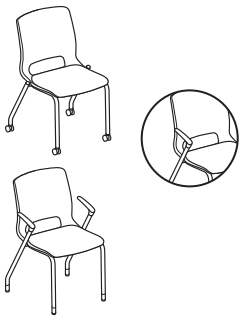

STACK CHAIR

Four Legs
Upholstered Seat
Set of 2

DIMENSIONS

| | | | |
|--------------|-----|-----------------------|----------|
| Depth: | 23 | Arm Width: | 18 |
| Width: | 21 | Seat to Floor Height: | 18¼ |
| Height: | 32¼ | Usable Seat Depth: | 18¼ |
| Seat Depth: | 18¼ | Ship Weight: | 44 |
| Seat Width: | 17¾ | Cube: | 13.0 |
| Back Width: | 17¼ | COM: | 1.0 |
| Back Height: | 17½ | Weight Rating: | 300 lbs. |

FABRIC PRICE CODES

| | | | |
|----------|--------------|-----------|--------------|
| 1 | \$650 | 8 | \$788 |
| 2 | \$674 | 9 | \$806 |
| 3 | \$698 | 10 | \$824 |
| 4 | \$716 | 11 | \$842 |
| 5 | \$734 | 12 | \$860 |
| 6 | \$752 | L | \$850 |
| 7 | \$770 | | |

NOTES: 4-Leg chairs stack 6-high on the floor.

M Motivate® 4-leg Chairs are ordered and shipped two (2) chairs per carton. Pricing shown is per carton. Each set of two chairs (one carton), must have the same shell/frame color combination. Ordering 2 of Model HMG1, HMG2 will result in 2 cartons being shipped, giving you 4 chairs. 4-Leg chairs stack 6-high on the floor.

HON Recommendation: HMG1.N.H.ON.PLAT - List Price \$528

HOW TO SPECIFY

| Select Model Number | Select Arm Type | Select Caster/Glide | Select Shell Color | Select Fabric | Select Frame |
|---|---|---|---|---|--|
| F Fixed Arms (+ \$30 per chair) N Armless | H Hard Caster S Soft Caster (+ \$20 per chair) <i>Casters only available on HMG1 and HMG2</i> E Standard Nylon Glide F Felt Glide (+ \$30 per chair) R Rubber Glide (+ \$30 per chair) T Steel Glide (+ \$30 per chair) | RG Tangelo CR Cherry LM Lime CP Calypso BU Surf RE Regatta MB Mulberry | LO Loft PT Platinum SD Shadow LA Lava ON Onyx WT White | See page 186 <i>Not specified for models HMG1 and HMG5</i> | BLCK Textured Black PLAT Textured Platinum Metallic |
| HMG1 . | N . | H . | ON . | | PLAT |
| HMG2 . | N . | H . | ON . | CU10 . | PLAT |

MOTIVATE[®] 4-Leg Chairs

GSA SIN 711-18



Icon Legend on page 17

HMG3

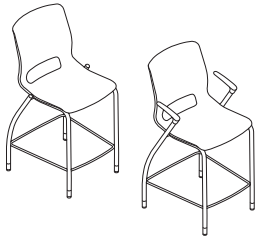

COUNTER-HEIGHT STOOL DIMENSIONS

Four Legs

| | | | |
|--------------|-----|-----------------------|----------|
| Depth: | 23 | Arm Width: | 18 |
| Width: | 21 | Seat to Floor Height: | 24½ |
| Height: | 40½ | Usable Seat Depth: | 18½ |
| Seat Depth: | 18½ | Ship Weight: | 26 |
| Seat Width: | 17¾ | Cube: | 13.8 |
| Back Width: | 17¼ | Weight Rating: | 300 lbs. |
| Back Height: | 18 | | |

LIST PRICE

\$332

NOTES: HMG3 shells are CA Technical Bulletin 133 compliant (no upcharge).

HMG4

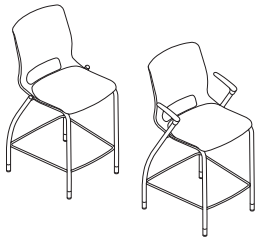

COUNTER-HEIGHT STOOL DIMENSIONS

Four Legs
Upholstered Seat

| | | | |
|--------------|-----|-----------------------|----------|
| Depth: | 23 | Arm Width: | 18 |
| Width: | 21 | Seat to Floor Height: | 25 |
| Height: | 40½ | Usable Seat Depth: | 18¼ |
| Seat Depth: | 18½ | Ship Weight: | 26 |
| Seat Width: | 17¾ | Cube: | 13.8 |
| Back Width: | 17¼ | COM: | 1.0 |
| Back Height: | 17½ | Weight Rating: | 300 lbs. |

FABRIC PRICE CODES

| | | | |
|----------|--------------|-----------|--------------|
| 1 | \$396 | 8 | \$534 |
| 2 | \$420 | 9 | \$552 |
| 3 | \$444 | 10 | \$570 |
| 4 | \$462 | 11 | \$588 |
| 5 | \$480 | 12 | \$606 |
| 6 | \$498 | L | \$596 |
| 7 | \$516 | | |

NOTES: Add "FC" suffix to Model Number for CA Technical Bulletin 133 compliance. Add upcharge of \$40.

HMG5

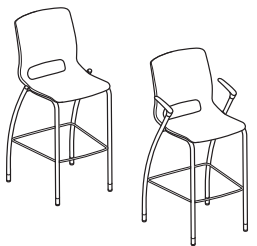

CAFÉ-HEIGHT STOOL DIMENSIONS

Four Legs

| | | | |
|--------------|-----|-----------------------|----------|
| Depth: | 23 | Arm Width: | 18 |
| Width: | 21 | Seat to Floor Height: | 30 |
| Height: | 44½ | Usable Seat Depth: | 18½ |
| Seat Depth: | 18½ | Ship Weight: | 30 |
| Seat Width: | 17¾ | Cube: | 19.3 |
| Back Width: | 17¼ | Weight Rating: | 300 lbs. |
| Back Height: | 18 | | |

LIST PRICE

\$351

NOTES: HMG5 shells are CA Technical Bulletin 133 compliant (no upcharge).

HMG7

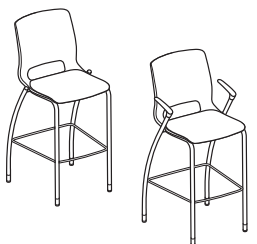

CAFÉ-HEIGHT STOOL DIMENSIONS

Four Legs
Upholstered Seat

| | | | |
|--------------|-----|-----------------------|----------|
| Depth: | 23 | Arm Width: | 18 |
| Width: | 21 | Seat to Floor Height: | 30½ |
| Height: | 44½ | Usable Seat Depth: | 18¼ |
| Seat Depth: | 18½ | Ship Weight: | 34 |
| Seat Width: | 17¾ | Cube: | 19.3 |
| Back Width: | 17¼ | COM: | 1.0 |
| Back Height: | 17½ | Weight Rating: | 300 lbs. |

FABRIC PRICE CODES

| | | | |
|----------|--------------|-----------|--------------|
| 1 | \$415 | 8 | \$553 |
| 2 | \$439 | 9 | \$571 |
| 3 | \$463 | 10 | \$589 |
| 4 | \$481 | 11 | \$607 |
| 5 | \$499 | 12 | \$625 |
| 6 | \$517 | L | \$615 |
| 7 | \$535 | | |

NOTES: Add "FC" suffix to Model Number for CA Technical Bulletin 133 compliance. Add upcharge of \$40.

HON Recommendation: HMG5.N.E.ON.PLAT - List Price \$351

HOW TO SPECIFY

| Select Model Number | Select Arm Type | Select Glide | Select Shell Color | Select Fabric | Select Frame |
|---|---|---|--|--|---|
| <p>F Fixed Arms (+ \$30 per chair)</p> <p>N Armless</p> | <p>E Standard Nylon Glide</p> <p>F Felt Glide (+ \$30 per chair)</p> <p>R Rubber Glide (+ \$30 per chair)</p> <p>T Steel Glide (+ \$30 per chair)</p> | <p>RG Tangelo</p> <p>CR Cherry</p> <p>LM Lime</p> <p>CP Calypso</p> <p>BU Surf</p> <p>RE Regatta</p> <p>MB Mulberry</p> | <p>LO Loft</p> <p>PT Platinum</p> <p>SD Shadow</p> <p>LA Lava</p> <p>ON Onyx</p> <p>WT White</p> | <p>See page 186</p> <p><i>Not specified for models HMG1 and HMG5</i></p> | <p>BLCK Textured Black</p> <p>PLAT Textured Platinum Metallic</p> |
| <p>HMG5</p> <p>HMG7</p> | <p>N</p> <p>N</p> | <p>E</p> <p>E</p> | <p>ON</p> <p>ON</p> | <p>CU10</p> | <p>PLAT</p> <p>PLAT</p> |

MOTIVATE® Nesting/Stacking Flex-Back Chair Options

MODEL OPTIONS

HMN1



Flex-back

Nesting/Stacking,
Four Legs

HMN2



Flex-back

Nesting/Stacking, Four
Legs, Upholstered Seat

ARM STYLE

| CODE | DESCRIPTION | PRICE |
|----------|-------------|--------------|
| F | Fixed Arms | +\$50 |
| N | Armless | +\$0 |



CASTERS/ GLIDE

| CODE | DESCRIPTION | PRICE |
|----------|----------------------|--------------|
| H | Hard Caster | +\$0 |
| S | Soft Caster | +\$20 |
| E | Standard Nylon Glide | +\$0 |



BACK STYLE

| CODE | DESCRIPTION | PRICE |
|------|-------------|-------|
|------|-------------|-------|

Plastic/Upholstered Options:



| | | |
|-----------|---------------|-------------|
| PS | Plastic Shell | +\$0 |
|-----------|---------------|-------------|



| | | |
|-----------|-------------|--------------|
| PB | Upholstered | +\$70 |
|-----------|-------------|--------------|

**PB only available on HMN2*

ilira® - stretch M4 Options:



| | | |
|-----------|----------|--------------|
| IM | Black | +\$80 |
| IF | Fox | +\$80 |
| IC | Charcoal | +\$80 |
| IH | Chai | +\$80 |
| IY | Navy | +\$80 |

PLASTIC SHELL COLOR CODES (no upcharge):

| | | | | |
|---------------------|----------------------|-------------------|----------------------|--------------------|
| Tangelo - RG | Cherry - CR | Lime - LM | Calypso - CP | Surf - BU |
| Regatta - RE | Mulberry - MB | Loft - LO | Platinum - PT | Shadow - SD |
| Lava - LA | Onyx - ON | White - WT | | |

MOTIVATE®

Nesting/Stacking Flex-Back Chair Fabric Options

HON BRANDED FABRICS

GRADE 1

Attire
Centurion
Compass
Contourette Polyurethane
Dapper
Hamilton
Inertia
Optic

GRADE 2

Appoint Seating
Clyde
Dotty
Rush
Seed
Spin Seating
Whisper Vinyl

GRADE 3

In Season
Purl
Silvertex™ Vinyl

GRADE L

Denver Leather

For a complete list of fabrics, including partnership fabrics, go to hon.com/fabricsandfinishes.

Reference Fabric Color Combinations on pages 20-24 for color codes and legend on page 21 for lead times.

 For Fire Code model, availability and ordering method, refer to pages 28-31. Available on select models, contact HON Customer Support for availability.



Icon Legend on page 17

MOTIVATE® Nesting/Stacking Flex-Back Chairs

HMN1

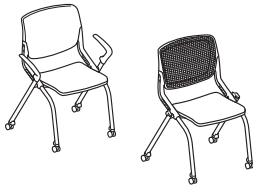

CHAIR

Flex-back
Nesting/Stacking
Four Legs

DIMENSIONS

| | | | |
|--------------|--------------------------------|-----------------------|--------------------------------|
| Depth: | 23 ³ / ₈ | Arm Width: | 24 |
| Width: | 26 ³ / ₄ | Seat to Floor Height: | 18 ¹ / ₄ |
| Height: | 34 | Usable Seat Depth: | 16 ³ / ₄ |
| Seat Depth: | 16 ³ / ₄ | Ship Weight: | 27 |
| Seat Width: | 17 | Cube: | 15.1 |
| Back Width: | 19 ¹ / ₂ | Weight Rating: | 300 lbs. |
| Back Height: | 19 | | |

LIST PRICE

\$429

NOTES: Stack 4-high on floor.

! When selecting the mesh back option, frame around mesh is always black. CA Technical Bulletin 133 compliant shells available in LA-Lava ONLY, ordering instructions below.

HMN2



CHAIR

Flex-back
Nesting/Stacking
Four Legs
Upholstered Seat

DIMENSIONS

| | | | |
|--------------|--------------------------------|----------------------------------|--------------------------------|
| Depth: | 23 ³ / ₈ | Seat to Floor Height: | 19 ¹ / ₄ |
| Width: | 26 ³ / ₄ | Usable Seat Depth: | 17 |
| Height: | 34 | Ship Weight (upholstered back): | 29 |
| Seat Depth: | 17 | Ship Weight (plastic/mesh back): | 28 |
| Seat Width: | 17 ³ / ₈ | Cube (upholstered back): | 15.1 |
| Back Width: | 19 ¹ / ₂ | Cube (plastic/mesh back): | 15.1 |
| Back Height: | 18 ³ / ₈ | COM (upholstered back): | 1.0 |
| Arm Width: | 24 | COM (plastic/mesh back): | 1.0 |
| | | Weight Rating: | 300 lbs. |

FABRIC PRICE CODES

| | | | |
|----------|--------------|-----------|--------------|
| 1 | \$493 | 8 | \$631 |
| 2 | \$517 | 9 | \$649 |
| 3 | \$541 | 10 | \$667 |
| 4 | \$559 | 11 | \$685 |
| 5 | \$577 | 12 | \$703 |
| 6 | \$595 | L | \$693 |
| 7 | \$613 | | |

NOTES: Stack 4-high on floor.

! When selecting the mesh back option, frame around mesh is always black. CA Technical Bulletin 133 compliant shells available in LA-Lava ONLY, ordering instructions below.

HON Recommendation: HMN1.N.H.IM.ON.CU__PLAT - List Price \$509

HOW TO SPECIFY

| Select Model Number | Select Arm Type | Select Caster/Glide | Select Back Type | Select Shell Color | Select Fabric | Select Frame |
|--|--|--|---|---|--|--|
| F Fixed Arms (+ \$50) N Armless | E Standard Nylon Glide H Hard Caster S Soft Caster (+ \$20) | PS Plastic Shell PB Upholstered (+ \$70) <i>PB option available on HMN2 only</i> ilira®-stretch M4 options (+ \$80) IM Black IF Fog IC Charcoal IH Chai IY Navy | RG Tangelo CR Cherry LM Lime CP Calypso BU Surf RE Regatta MB Mulberry | LO Loft PT Platinum SD Shadow LA Lava ON Onyx WT White | See page 190 <i>Specify for model HMN2 only</i> | BLCK Textured Black PLAT Textured Platinum Metallic |
| HMN1 | N | H | IM | ON | | PLAT |
| HMN2 | N | H | PB | ON | CU10 | PLAT |

MOTIVATE[®]

Chair with Tablet Arm Options

MODEL OPTIONS

HMG1



with Tablet Arm

Four Legs

HMG2



with Tablet Arm

Four Legs, Upholstered Seat

CASTERS/ GLIDES



| CODE | DESCRIPTION | PRICE |
|----------|-------------|-------------|
| H | Hard Caster | +\$0 |



| | | |
|----------|-------------|--------------|
| S | Soft Caster | +\$20 |
|----------|-------------|--------------|



| | | |
|----------|----------------------|--------------|
| E | Standard Nylon Glide | +\$0 |
| F | Felt Glide | +\$30 |
| R | Rubber Glide | +\$30 |
| T | Steel Glide | +\$30 |

TABLET SIDE



| CODE | DESCRIPTION | PRICE |
|-----------|-------------|-------------|
| RT | Right Side | +\$0 |
| LT | Left Side | +\$0 |



TABLET COLOR

| CODE | DESCRIPTION | PRICE |
|----------|---------------|-------------|
| T | Black | +\$0 |
| D | Natural Maple | +\$0 |

FRAME

| CODE | DESCRIPTION | PRICE |
|-------------|----------------------------|-------------|
| BLCK | Textured Black | +\$0 |
| PLAT | Textured Platinum Metallic | +\$0 |

PLASTIC SHELL COLOR CODES (no upcharge):

| | | | | |
|---------------------|----------------------|-------------------|----------------------|--------------------|
| Tangelo - RG | Cherry - CR | Lime - LM | Calypso - CP | Surf - BU |
| Regatta - RE | Mulberry - MB | Loft - LO | Platinum - PT | Shadow - SD |
| Lava - LA | Onyx - ON | White - WT | | |

! CA Technical Bulletin 133 compliant shells available in all 13 shell colors (no upcharge).

MOTIVATE®

Chair with Tablet Arm Fabric Options

HON BRANDED FABRICS

GRADE 1

Attire
Centurion
Compass
Contourette Polyurethane
Dapper
Hamilton
Inertia
Optic

GRADE 2

Appoint Seating
Clyde
Dotty
Rush
Seed
Spin Seating
Whisper Vinyl

GRADE 3

In Season
Purl
Silvertex™ Vinyl

GRADE L

Denver Leather

For a complete list of fabrics, including partnership fabrics, go to hon.com/fabricsandfinishes.

Reference Fabric Color Combinations on pages 20-24 for color codes and legend on page 21 for lead times.

 For Fire Code model, availability and ordering method, refer to pages 28-31. Available on select models, contact HON Customer Support for availability.

MOTIVATE® Chair with Tablet Arm

GSA SIN 711-18



Icon Legend on page 17

HMGT1

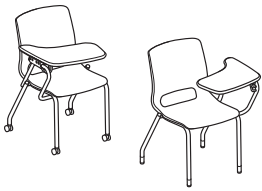

CHAIR

with Tablet Arm
Four Legs

DIMENSIONS

| | | | |
|-------------|-----|---------------------------|----------|
| Depth: | 30 | Back Width: | 17¼ |
| Width: | 21 | Back Height: | 18 |
| Height: | 32¼ | Seat to Floor Height: | 17¾ |
| Seat Depth: | 18¼ | Tablet Height from Floor: | 28¾ |
| Seat Width: | 17¾ | Ship Weight: | 41 |
| | | Cube: | 18.4 |
| | | Weight Rating: | 300 lbs. |

LIST PRICE PER CARTON

\$443

NOTES: HMGT1 shells are CA Technical Bulletin 133 compliant (no upcharge). Tablet can be specified on right or left side.

HMGT2

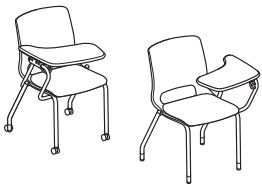

CHAIR

with Tablet Arm
Four Legs
Upholstered Seat

DIMENSIONS

| | | | |
|-------------|-----|---------------------------|----------|
| Depth: | 30 | Back Width: | 17¼ |
| Width: | 21 | Back Height: | 17½ |
| Height: | 32¼ | Seat to Floor Height: | 18¼ |
| Seat Depth: | 18¼ | Tablet Height from Floor: | 28¾ |
| Seat Width: | 17¾ | Ship Weight: | 43 |
| | | Cube: | 18.4 |
| | | Weight Rating: | 300 lbs. |

FABRIC PRICE CODES

| | | | |
|----------|--------------|-----------|--------------|
| 1 | \$504 | 8 | \$642 |
| 2 | \$528 | 9 | \$660 |
| 3 | \$552 | 10 | \$678 |
| 4 | \$570 | 11 | \$696 |
| 5 | \$588 | 12 | \$714 |
| 6 | \$606 | L | \$704 |
| 7 | \$624 | | |

NOTES: Tablet can be specified on right or left side.

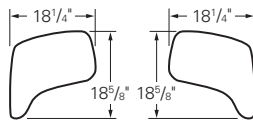

HON Recommendation: HMGT1.E.ON.RT.D.PLAT - List Price \$443

HOW TO SPECIFY

| Select Model Number | Select Caster/Glide | Select Shell Color | Select Fabric | Select Tablet Side | Select Tablet Color | Select Frame |
|----------------------------|---|---|---|-------------------------------|----------------------------|--|
| H S E F R T | H Hard Caster S Soft Caster (+ \$20 per chair) E Standard Nylon Glide F Felt Glide (+ \$30 per chair) R Rubber Glide (+ \$30 per chair) T Steel Glide (+ \$30 per chair) | RG Tangelo CR Cherry LM Lime CP Calypso BU Surf RE Regatta MB Mulberry LO Loft PT Platinum SD Shadow LA Lava ON Onyx WT White | See page 193 <i>Not specified for HMGT1 models</i> | RT Right Side LT Left Side | T Black D Natural Maple | BLCK Textured Black PLAT Textured Platinum Metallic |
| HMGT1 | E | ON | | RT | D | PLAT |
| HMGT2 | E | ON | CU10 | RT | D | PLAT |

MOTIVATE® Flex-Back Chair with Tablet Arm Options

MODEL OPTIONS

HMNT1



Flex-back with Tablet Arm

HMNT2



Flex-back with Tablet Arm
Upholstered Seat

CASTERS/ GLIDE



| CODE | DESCRIPTION | PRICE |
|----------|-------------|-------------|
| H | Hard Caster | +\$0 |



| | | |
|----------|-------------|--------------|
| S | Soft Caster | +\$20 |
|----------|-------------|--------------|



| | | |
|----------|----------------------|-------------|
| E | Standard Nylon Glide | +\$0 |
|----------|----------------------|-------------|

TABLET SIDE



| CODE | DESCRIPTION | PRICE |
|-----------|-------------|-------------|
| RT | Right Side | +\$0 |
| LT | Left Side | +\$0 |



BACK STYLE

| CODE | DESCRIPTION | PRICE |
|------|-------------|-------|
|------|-------------|-------|

Plastic/Upholstered Options:



| | | |
|-----------|---------------|-------------|
| PS | Plastic Shell | +\$0 |
|-----------|---------------|-------------|



| | | |
|-----------|-------------|--------------|
| PB | Upholstered | +\$70 |
|-----------|-------------|--------------|

ilira® - stretch M4 Options:



| | | |
|-----------|-------|--------------|
| IM | Black | +\$80 |
|-----------|-------|--------------|

| | | |
|-----------|-----|--------------|
| IF | Fog | +\$80 |
|-----------|-----|--------------|

| | | |
|-----------|----------|--------------|
| IC | Charcoal | +\$80 |
|-----------|----------|--------------|

| | | |
|-----------|------|--------------|
| IH | Chai | +\$80 |
|-----------|------|--------------|

| | | |
|-----------|------|--------------|
| IY | Navy | +\$80 |
|-----------|------|--------------|

TABLET COLOR

| CODE | DESCRIPTION | PRICE |
|----------|---------------|-------------|
| T | Black | +\$0 |
| D | Natural Maple | +\$0 |

FRAME

| CODE | DESCRIPTION | PRICE |
|-------------|----------------------------|-------------|
| BLCK | Textured Black | +\$0 |
| PLAT | Textured Platinum Metallic | +\$0 |

| PLASTIC SHELL COLOR CODES (no upcharge): | | Tangelo - RG | Cherry - CR | Lime - LM | Calypso - CP | Surf - BU |
|--|--|---------------------|----------------------|-------------------|----------------------|--------------------|
| | | Regatta - RE | Mulberry - MB | Loft - LO | Platinum - PT | Shadow - SD |
| | | Lava - LA | Onyx - ON | White - WT | | |

MOTIVATE[®]

Flex-Back Chair with Tablet Arm Fabric Options

HON BRANDED FABRICS

GRADE 1

Attire
Centurion
Compass
Contourette Polyurethane
Dapper
Hamilton
Inertia
Optic

GRADE 2

Appoint Seating
Clyde
Dotty
Rush
Seed
Spin Seating
Whisper Vinyl

GRADE 3

In Season
Purl
Silvertex[™] Vinyl

GRADE L

Denver Leather

For a complete list of fabrics, including partnership fabrics, go to hon.com/fabricsandfinishes.

Reference Fabric Color Combinations on pages 20-24 for color codes and legend on page 21 for lead times.

 For Fire Code model, availability and ordering method, refer to pages 28-31. Available on select models, contact HON Customer Support for availability.



Icon Legend on page 17

MOTIVATE® Flex-Back Chair with Tablet Arm

HMNT1

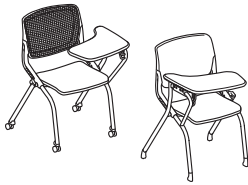

CHAIR

Flex-back with Tablet Arm

DIMENSIONS

| | | | |
|--------------|--------------------------------|---------------------------|--------------------------------|
| Depth: | 30 ³ / ₈ | Seat to Floor Height: | 18 ¹ / ₄ |
| Width: | 23 ¹ / ₂ | Tablet Height from Floor: | 29 ¹ / ₂ |
| Height: | 34 | Ship Weight: | 41 |
| Seat Depth: | 17 ¹ / ₄ | Cube: | 18.4 |
| Seat Width: | 17 | Weight Rating: | 300 lbs. |
| Back Width: | 19 ¹ / ₂ | | |
| Back Height: | 19 | | |

LIST PRICE

\$608

NOTES: Add **"FC"** suffix to Model Number for CA Technical Bulletin 133 compliance. Shell available in Lava (LA) only. See pages 28-31. Add upcharge of \$40 per carton to graded price. Tablet can be specified on right or left side.

❗ Model HMNT1 is not available with an upholstered back. CA Technical Bulletin 133 compliant shells available in LA-Lava ONLY, ordering instructions below.

HMNT2

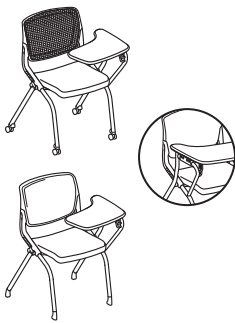

CHAIR

Flex-back with Tablet Arm
Upholstered Seat

DIMENSIONS

| | | | |
|--------------|--------------------------------|---------------------------|--------------------------------|
| Depth: | 30 ³ / ₈ | Seat to Floor Height: | 19 ¹ / ₄ |
| Width: | 23 ¹ / ₂ | Tablet Height from Floor: | 29 ¹ / ₂ |
| Height: | 34 | Ship Weight: | 42 |
| Seat Depth: | 17 ⁵ / ₈ | Cube: | 18.4 |
| Seat Width: | 17 ⁵ / ₈ | Weight Rating: | 300 lbs. |
| Back Width: | 19 ¹ / ₂ | | |
| Back Height: | 18 ⁵ / ₈ | | |

FABRIC PRICE CODES

| | | | |
|----------|--------------|-----------|--------------|
| 1 | \$671 | 8 | \$809 |
| 2 | \$695 | 9 | \$827 |
| 3 | \$719 | 10 | \$845 |
| 4 | \$737 | 11 | \$863 |
| 5 | \$755 | 12 | \$881 |
| 6 | \$773 | L | \$871 |
| 7 | \$791 | | |

NOTES: Tablet can be specified on right or left side.

❗ CA Technical Bulletin 133 compliant shells available in LA-Lava ONLY, ordering instructions below.

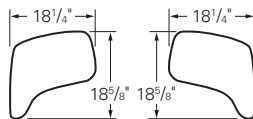

HON Recommendation: HMNT1.E.IM.ON.RT.D.PLAT - List Price \$688

HOW TO SPECIFY

| Select Model Number | Select Caster/Glide | Select Back Type | Select Shell Color | Select Fabric | Select Tablet Side | Select Tablet Color | Select Frame |
|---------------------|--|--|--|---|---|--|--|
| | E Standard Nylon Guide H Hard Caster S Soft Caster (+ \$20) | PS Plastic Shell PB Upholstered (+ \$70) <i>PB option not available on HMNT1</i> ilira®-stretch M4 options (+ \$80) IM Black IF Fog IC Charcoal IH Chai IY Navy | RG Tangelo CR Cherry LM Lime CP Calypso BU Surf RE Regatta MB Mulberry LO Loft PT Platinum SD Shadow LA Lava ON Onyx WT White | See page 196 <i>Specify for model HMNT2 only</i> | RT Right Side LT Left Side | T Black D Natural Maple | BLCK Textured Black PLAT Textured Platinum Metallic |
| HMNT1 | E | IM | ON | | RT | D | PLAT |
| HMNT2 | E | PB | ON | CU10 | RT | D | PLAT |

NETWORK™

HVL281



LOW-BACK TASK CHAIR

Upholstered
Swivel-tilt
Armless
Functions: **A, E, F, K, L**
(Function Key on pages 18-19)

DIMENSIONS

| | | | |
|-------------|-----|-----------------------|----------|
| Depth: | 25½ | Back Width: | 17¾ |
| Width: | 25½ | Back Height: | 17¾ |
| Height: | 37½ | Seat to Floor Height: | 17-21½ |
| Seat Depth: | 16½ | Ship Weight: | 27.9 |
| Seat Width: | 18⅝ | Cube: | 4.3 |
| | | Weight Rating: | 250 lbs. |

LIST PRICE

\$185

NOTES: HON 5-Year Limited Warranty.

HON Recommendation: HVL281.Z1.VA10.T - List Price \$185

HVL282



MID-BACK TASK CHAIR

Upholstered
Swivel-tilt
Height and Width Adjustable
Arms
Height Adjustable Back
Functions: **A, B, E, F, K, L, S**
(Function Key on pages 18-19)

DIMENSIONS

| | | | |
|--------------|-----|-----------------------|----------|
| Depth: | 25¼ | Arm Width: | 18½ |
| Width: | 26½ | Seat to Floor Height: | 18¾-22¾ |
| Height: | 43¾ | Ship Weight: | 47.0 |
| Seat Depth: | 16¾ | Cube: | 6.0 |
| Seat Width: | 19⅞ | Weight Rating: | 250 lbs. |
| Back Width: | 19⅞ | | |
| Back Height: | 20½ | | |

LIST PRICE

Swivel-tilt \$298
Asynchronous \$353

NOTES: HON 5-Year Limited Warranty.

HON Recommendation: HVL282.Z1.VA10.T - List Price \$298

HVL283



HIGH-BACK TASK CHAIR

Upholstered
Asynchronous with Seat Slide
Height and Width Adjustable
Arms
Functions: **A, D, E, O, S**
(Function Key on pages 18-19)

DIMENSIONS

| | | | |
|--------------|-----|-----------------------|----------|
| Depth: | 25¼ | Arm Width: | 17¾ |
| Width: | 26½ | Seat to Floor Height: | 18¾-22¾ |
| Height: | 47¼ | Ship Weight: | 53.3 |
| Seat Depth: | 17⅞ | Cube: | 6.9 |
| Seat Width: | 19⅞ | Weight Rating: | 250 lbs. |
| Back Width: | 20⅞ | | |
| Back Height: | 23⅝ | | |

LIST PRICE

\$421

NOTES: HON 5-Year Limited Warranty.

HON Recommendation: HVL283.A2.VA10.T - List Price \$421

HVL289



ADJUSTABLE ARM PACK

Height and Width
Available in Black (T)
Functions: **S**
(Function Key on pages 18-19)

DIMENSIONS

| | |
|-----------------------|--------|
| Adjustable Arm Width: | 18¼ |
| Height from Seat: | 7⅞-10⅝ |
| Ship Weight: | 9.8 |
| Cube: | 0.8 |

LIST PRICE

\$57

HON Recommendation: HVL289.T - List Price \$57

HOW TO SPECIFY

| | | | |
|---|---|---|--|
| <p>Select Model Number</p> <p>H V L 2 8 1 .</p> | <p>Select Control</p> <p>Z1 Swivel Tilt Available on HVL281 and HVL282 only</p> <p>A2 Asynchronous with Seat Slide Available on HVL282 and HVL283 only</p> <p>Z 1 .</p> | <p>Select Fabric</p> <p>VA10 Black Fabric</p> <p>V A 1 0 .</p> | <p>Select Frame</p> <p>T Black</p> <p>T</p> |
|---|---|---|--|

NUCLEUS®



Nucleus Work Chairs shown with Preside® Conference Table.

NUCLEUS®

Enjoy seating that delivers comfort from the inside out. Nucleus task and guest chairs adapt to everyone's unique body types to create a custom fit and targeted support. The back flexes with the spine. The seat cradles you like a hammock. The sophisticated aesthetic makes a stylish statement. Nucleus is the powerhouse seating family that brings cool and comfortable together.



GUEST CHAIR FEATURES

- Stacking chairs stack up to four high on the floor.
- Choose between glides, soft casters or hard casters.
- HN6 guest chair available with glides, hard or soft casters.
- Available in hundreds of quality HON fabrics.
- Warranted for users up to 300 lbs.

TASK CHAIR FEATURES

- Advanced suspension material in the seat combines with molded foam to create unparalleled support.
- Choose between the ilira®-stretch mesh back or an upholstered suspension back.
- ilira®-stretch mesh back is available in five colors.
- Choose between armless, fixed arms or height- and width-adjustable arms.
- Responsive synchro-tilt control provides a smooth, natural recline.
- Available in Black or Polished Aluminum base.
- Tilt tension controls the rate and ease of recline.
- Tilt lock allows the user to lock out the tilt function.
- 360-degree swivel provides freedom of movement in any direction.
- Available in hundreds of quality HON fabrics.
- Warranted for users up to 300 lbs.

NUCLEUS[®] Task Chair Options

MODEL OPTIONS

HN1



Task Chair (ilira[®]-stretch M4 Back)

Pneumatic, Swivel, Seat Glide, Synchro-tilt, Tilt Tension, Tilt Lock, Armless

HN1U



Task Chair (Upholstered Back)

Pneumatic, Swivel, Seat Glide, Synchro-tilt, Tilt Tension, Tilt Lock, Armless

ARM STYLE

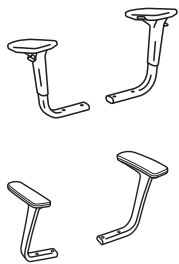

| CODE | DESCRIPTION | PRICE |
|----------|----------------------------------|---------------|
| N | Armless | +\$0 |
| A | Height and Width Adjustable Arms | +\$75 |
| P | Fixed Arms - Polished | +\$150 |

BASE

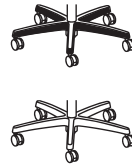

| CODE | DESCRIPTION | PRICE |
|-----------|-------------------|---------------|
| SB | Standard Base | +\$0 |
| PA | Polished Aluminum | +\$110 |

CASTERS



| CODE | DESCRIPTION | PRICE |
|----------|-------------|--------------|
| H | Hard Caster | +\$0 |
| S | Soft Caster | +\$30 |

FRAME

| CODE | DESCRIPTION | PRICE |
|----------|-------------|-------------|
| T | Black | +\$0 |

BACK STYLE

| CODE | DESCRIPTION | PRICE |
|---|-------------|-------------|
| <i>ilira[®]-stretch mesh back options:</i> | | |
| IM | Black | +\$0 |
| IF | Fog | +\$0 |
| IC | Charcoal | +\$0 |
| IH | Chai | +\$0 |
| IY | Navy | +\$0 |

NUCLEUS® Multi-Purpose and Café Chair Options

MODEL OPTIONS

HN6



**Multi-Purpose Stack Chair
(ilira®-stretch M4 Back)**

Four Legs

HN7

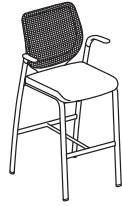

**Café-Height Stool (ilira®-stretch
M4 Back)**

Four Legs

ARM STYLE

| CODE | DESCRIPTION | PRICE |
|----------|-------------|--------------|
| N | Armless | +\$0 |
| F | Fixed Arms | +\$30 |



CASTERS/ GLIDE

| CODE | DESCRIPTION | PRICE |
|----------|---|--------------|
| H | Hard Caster <i>*Not available on HN7</i> | +\$0 |
| S | Soft Caster <i>*Not available on HN7</i> | +\$20 |
| E | Glide | +\$0 |



BACK STYLE

| CODE | DESCRIPTION | PRICE |
|--|-------------|-------------|
| <i>ilira®-stretch mesh back options:</i> | | |
| IM | Black | +\$0 |
| IF | Fog | +\$0 |
| IC | Charcoal | +\$0 |
| IH | Chai | +\$0 |
| IY | Navy | +\$0 |

FRAME

| CODE | DESCRIPTION | PRICE |
|-----------|-------------------|-------------|
| T | Black | +\$0 |
| T1 | Platinum Metallic | +\$0 |

NUCLEUS[®]

Fabric Options

HON BRANDED FABRICS

GRADE 1

Attire
Centurion
Compass
Contourette Polyurethane
Dapper
Hamilton
Inertia
Optic

GRADE 2

Appoint Seating
Clyde
Dotty
Rush
Seed
Spin Seating
Whisper Vinyl

GRADE 3

In Season
Purl
Silvertex™ Vinyl

GRADE L

Denver Leather

For a complete list of fabrics, including partnership fabrics, go to hon.com/fabricsandfinishes.

Reference Fabric Color Combinations on pages 20-24 for color codes and legend on page 21 for lead times. For additional HON to Supply COM fabric grade pricing, go to honready.hon.com and click on the HON to Supply COM link.

 For Fire Code model, availability and ordering method, refer to pages 28-31. Available on select models, contact HON Customer Support for availability.



Icon Legend on page 17

HN1



TASK CHAIR

ilira®-stretch M4 Back

- Pneumatic
- Swivel
- Seat Glide
- Synchro-tilt
- Tilt Tension
- Tilt Lock
- Armless

Functions:

A, D, E, A-C, A-D, J, L

(Function Key on pages 18-19)

HON Recommendation: HN1.A.H.IM.CU__SB.T - List Price \$885

DIMENSIONS

| | | | |
|--------------|-----|-----------------------|----------|
| Depth: | 25¾ | Arm Width: | 17-20 |
| Width: | 28¾ | Seat to Floor Height: | 17-22 |
| Height: | 45¼ | Usable Seat Depth: | 16½-19 |
| Seat Depth: | 20 | Ship Weight: | 52 |
| Seat Width: | 20 | Cube: | 11.3 |
| Back Width: | 19¼ | COM: | 1.0 |
| Back Height: | 25¼ | Weight Rating: | 300 lbs. |

FABRIC PRICE CODES

| | | | |
|----------|--------------|-----------|---------------|
| 1 | \$810 | 8 | \$948 |
| 2 | \$834 | 9 | \$966 |
| 3 | \$858 | 10 | \$984 |
| 4 | \$876 | 11 | \$1002 |
| 5 | \$894 | 12 | \$1020 |
| 6 | \$912 | L | \$1010 |
| 7 | \$930 | | |

HOW TO SPECIFY

| Select Model Number | Select Arm Type | Select Caster/Glide | Select Back Type | Select Fabric | Select Base | Select Frame |
|--|---|--|------------------|--|--------------------------------|--------------|
| N Armless A Height and Width Adjustable Arms (+ \$75) P Fixed Arms - Polished (+ \$150) | H Hard Caster S Soft Caster (+ \$30) | ilira®-stretch options IM Black IF Fog IC Charcoal IH Chai IY Navy | See page 202 | SB Standard Base PA Polished Aluminum (+ \$110) | See page 200 T Black | |
| HN1 | A | H | IM | CU10 | SB | T |

HN1U



TASK CHAIR

Upholstered Back

- Pneumatic
- Swivel
- Seat Glide
- Synchro-tilt
- Tilt Tension
- Tilt Lock
- Armless

Functions:

A, D, E, A-C, A-D, J, L

(Function Key on pages 18-19)

HON Recommendation: HN1U.A.H.CU__SB.T - List Price \$885

DIMENSIONS

| | | | |
|--------------|-----|-----------------------|----------|
| Depth: | 26 | Arm Width: | 19⅞ |
| Width: | 28¾ | Seat to Floor Height: | 17-22 |
| Height: | 44¼ | Usable Seat Depth: | 16-18½ |
| Seat Depth: | 20 | Ship Weight: | 49 |
| Seat Width: | 20 | Cube: | 12.6 |
| Back Width: | 18¼ | COM: | 2.0 |
| Back Height: | 25½ | Weight Rating: | 300 lbs. |

FABRIC PRICE CODES

| | | | |
|----------|---------------|-----------|---------------|
| 1 | \$810 | 8 | \$1086 |
| 2 | \$858 | 9 | \$1122 |
| 3 | \$906 | 10 | \$1158 |
| 4 | \$942 | 11 | \$1194 |
| 5 | \$978 | 12 | \$1230 |
| 6 | \$1014 | L | \$1210 |
| 7 | \$1050 | | |

HOW TO SPECIFY

| Select Model Number | Select Arm Type | Select Caster/Glide | Select Fabric | Select Base | Select Frame |
|--|---|---------------------|--|--------------------------------|--------------|
| N Armless A Height and Width Adjustable Arms (+ \$75) P Fixed Arms - Polished (+ \$150) | H Hard Caster S Soft Caster (+ \$30) | See page 202 | SB Standard Base PA Polished Aluminum (+ \$110) | See page 200 T Black | |
| HN1U | A | H | CU10 | SB | T |



HN6

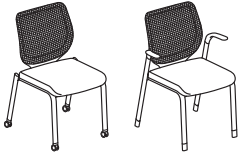

SIN 711-19

MULTI-PURPOSE STACK CHAIR

ilira®-stretch M4 Back
Four Legs



DIMENSIONS

| | | | |
|--------------|-----|-----------------------|----------|
| Depth: | 26½ | Arm Width: | 21½ |
| Width: | 27 | Seat to Floor Height: | 18½ |
| Height: | 37⅞ | Usable Seat Depth: | 18½ |
| Seat Depth: | 19 | Ship Weight: | 31 |
| Seat Width: | 19 | Cube: | 15.2 |
| Back Width: | 18 | COM: | 1.0 |
| Back Height: | 18½ | Weight Rating: | 300 lbs. |

FABRIC PRICE CODES

| | | | |
|---|-------|----|-------|
| 1 | \$506 | 8 | \$644 |
| 2 | \$530 | 9 | \$662 |
| 3 | \$554 | 10 | \$680 |
| 4 | \$572 | 11 | \$698 |
| 5 | \$590 | 12 | \$716 |
| 6 | \$608 | L | \$706 |
| 7 | \$626 | | |

HN7

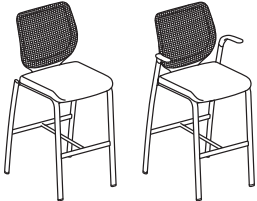

SIN 711-18

CAFÉ-HEIGHT STOOL

ilira®-stretch M4 Back
Four Legs



DIMENSIONS

| | | | |
|--------------|-----|-----------------------|----------|
| Depth: | 24½ | Arm Width: | 21½ |
| Width: | 25 | Seat to Floor Height: | 30 |
| Height: | 46½ | Usable Seat Depth: | 18½ |
| Seat Depth: | 19 | Ship Weight: | 40 |
| Seat Width: | 19 | Cube: | 21.4 |
| Back Width: | 18 | COM: | 1.0 |
| Back Height: | 18½ | Weight Rating: | 300 lbs. |

FABRIC PRICE CODES

| | | | |
|---|-------|----|-------|
| 1 | \$551 | 8 | \$689 |
| 2 | \$575 | 9 | \$707 |
| 3 | \$599 | 10 | \$725 |
| 4 | \$617 | 11 | \$743 |
| 5 | \$635 | 12 | \$761 |
| 6 | \$653 | L | \$751 |
| 7 | \$671 | | |

HON Recommendation: HN6.F.H.IM.CU__T - List Price \$536

HOW TO SPECIFY

| | | | | | |
|---------------------------------------|--|--|--|--------------------------------------|--|
| Select Model Number HN6 | Select Arm Type F Fixed Arms (+ \$30) N Armless | Select Caster/Glide E Glide H Hard Caster S Soft Caster (+ \$20) <i>Casters available on HN6 only</i> | Select Back Type ilira®-stretch options IM Black IF Fog IC Charcoal IH Chai IY Navy | Select Fabric See page 202 | Select Frame T Black T1 Platinum Metallic |
|---------------------------------------|--|--|--|--------------------------------------|--|

HNATA

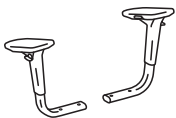

SIN 711-18

ADJUSTABLE ARM PACK

Height and Width
Functions: **S**
(Function Key on pages 18-19)

DIMENSIONS

| | |
|-------------------|--------------|
| Arm Width: | 17-20 |
| Height from Seat: | 6⅞-10⅞ |
| Ship Weight: | 7.5 S |
| Cube: | 1.0 |

LIST PRICE

\$117

HNFPA



OPEN MARKET

POLISHED ALUMINUM ARM PACK

Fixed Height

DIMENSIONS

| | |
|-------------------|--------------|
| Arm Width: | 19⅞ |
| Height from Seat: | 7¼ |
| Ship Weight: | 7.5 S |
| Cube: | 1.0 |

LIST PRICE

\$185

HOW TO SPECIFY

| |
|---|
| Select Model Number HNATA |
|---|

HIGH-DENSITY OLSON STACKER® 4040 SERIES



Olson Stacker.

HIGH-DENSITY OLSON STACKER® 4040 SERIES

Adaptable spaces such as multi-purpose and training areas demand a chair equally flexible. Olson stacking chairs fit that bill with a lightweight frame that is easy to move throughout a space. Chairs stack up to 12 high on the floor or up to 40 high on their specially designed cart to maximize floor space when not in use. A convenient cutout in the back makes it easy to pick up and move, while the molded seat shells deliver surprising comfort. Olson stacking chairs ship in sets of four to accommodate large groups. With Olson, the benefits really stack up.



FEATURES

- Chairs ship four per carton.
- Contoured seat and back shell provide targeted support.
- Integrated lumbar support delivers long-lasting comfort.
- Integrated handle makes chair easy to carry.
- Optional ganging brackets connect chairs to form neat rows.
- Stacks up to 12 high without cart.
- Stacks up to 40 high on cart.
- Shell colors are CA Technical Bulletin 133 compliant.
- Warranted for users up to 300 lbs.

HIGH-DENSITY OLSON STACKER® 4040 Series

GSA SIN 711-19



Icon Legend on page 17

H4041



POLYMER SEAT AND BACK DIMENSIONS

7/16" Steel Rod Frame
Chrome Legs

| | | | |
|--------------|--------|-----------------------|----------|
| Depth: | 21 5/8 | Seat to Floor Height: | 17 3/4 |
| Width: | 19 1/8 | Usable Seat Depth: | 17 |
| Height: | 30 5/8 | Ship Weight: | 57 Ⓢ |
| Seat Depth: | 18 1/4 | Cube: | 10.6 |
| Seat Width: | 17 3/4 | Weight Rating: | 300 lbs. |
| Back Width: | 17 1/2 | | |
| Back Height: | 16 1/4 | | |

LIST PRICE PER CARTON

\$669
(reference single unit @
\$167.25

⊕ 4040 Series is ordered and shipped four (4) chairs per carton. Pricing shown is per carton. Each set of four (one carton), must have the same shell color. Ordering 2 of Model H4041 will result in 2 cartons being shipped, giving you 8 chairs.

! Shipped fully assembled — 4 chairs per carton. All High-Density Olson Stacker® shell colors are CA Technical Bulletin 133 compliant (no upcharge).

🔥 For Fire Code model, availability and ordering method, refer to pages 28-31.

H4043



CART FOR STACKING CHAIRS

DIMENSIONS

| | | | |
|---------|--------|--------------|------|
| Depth: | 35 1/2 | Ship Weight: | 34 Ⓢ |
| Width: | 21 5/8 | Cube: | 7.8 |
| Height: | 37 | | |

LIST PRICE

\$479

NOTES: Holds 40 stack chairs (6'-8"), some assembly required. (Chairs stack 12 high without cart.)

! Specify Black paint (T) ONLY.

H4048

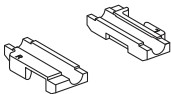

GANGING CHAIR GLIDES

DIMENSIONS

| | | |
|--|--------------|------|
| Box of 48 | Ship Weight: | 1 Ⓢ |
| For use on models H4041, HG51 and HG52 | Cube: | 0.04 |

LIST PRICE

\$119

H4049

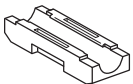

NON-GANGING CHAIR GLIDES

DIMENSIONS

| | | |
|---|--------------|------|
| Box of 48 | Ship Weight: | 1 Ⓢ |
| For use on models H4041, HFLEX01, HG51 and HG52 | Cube: | 0.04 |

LIST PRICE

\$94

HOW TO SPECIFY

| | | | | | | | | | | | | | | | | |
|---|---|------------|---------|-----------|-------------|---------|-----------|------------|---------|---------|---------|------------|----------|-------------|--|--|
| <p>Select Model Number</p> <p>H 4 0 4 1 .</p> | <p>Select Shell Color</p> <table border="0"> <tr> <td>RG Tangelo</td> <td>LO Loft</td> </tr> <tr> <td>CR Cherry</td> <td>PT Platinum</td> </tr> <tr> <td>LM Lime</td> <td>SD Shadow</td> </tr> <tr> <td>CP Calypso</td> <td>LA Lava</td> </tr> <tr> <td>BU Surf</td> <td>ON Onyx</td> </tr> <tr> <td>RE Regatta</td> <td>WT White</td> </tr> <tr> <td>MB Mulberry</td> <td></td> </tr> </table> <p>ON .</p> | RG Tangelo | LO Loft | CR Cherry | PT Platinum | LM Lime | SD Shadow | CP Calypso | LA Lava | BU Surf | ON Onyx | RE Regatta | WT White | MB Mulberry | | <p>Select Frame</p> <p>Y Chrome</p> <p>Y</p> |
| RG Tangelo | LO Loft | | | | | | | | | | | | | | | |
| CR Cherry | PT Platinum | | | | | | | | | | | | | | | |
| LM Lime | SD Shadow | | | | | | | | | | | | | | | |
| CP Calypso | LA Lava | | | | | | | | | | | | | | | |
| BU Surf | ON Onyx | | | | | | | | | | | | | | | |
| RE Regatta | WT White | | | | | | | | | | | | | | | |
| MB Mulberry | | | | | | | | | | | | | | | | |

PAGODA®



Pagoda Guest Chairs
and Café Stools.

PAGODA®

Roll out the welcome mat with Pagoda guest chairs. Reception areas. Private offices. Anywhere in between. Pagoda is a coordinated, versatile collection of stacking chairs and stools that easily match any environment and offer comfort for any type of activity. Standard-height chairs stack up to five high to clear valuable floor space whenever needed. Counter-height stools are great for cafés or common areas. Wherever comfort and style are equally important, Pagoda will create the look and feel you need.



FEATURES

- Guest chairs stack up to five high on the floor.
- Fully-upholstered outer back.
- Molded seat underpan protects seat fabric and creates a finished appearance when stacked.
- Optional fixed arms are gently sloped for maximum comfort.
- Tube rolled steel frame adds durability.
- Create a contemporary mixed material aesthetic.
- Optional wood veneer back is available in five attractive finishes.
- Available in hundreds of quality HON fabrics.
- Warranted for users up to 250 lbs.

PAGODA[®]

Options

MODEL OPTIONS

H4071



Stacking Arm Guest Chairs
Set of Two

H4073



Stacking Armless Guest Chairs
Set of Two

H4075



Stacking Arm Guest Chairs
Set of Two

H4077



Mobile Stacking Armless Guest Chairs
Set of Two

H4091



Stacking Arm Guest Chairs (Wood Back)
Set of Two

H4093



Stacking Armless Guest Chairs (Wood Back)
Set of Two

H4095



Stacking Arm Guest Chairs (Wood Back)
Set of Two

H4097



Mobile Stacking Armless Guest Chairs (Wood Back)
Set of Two

H4099

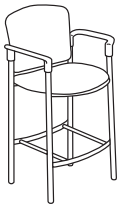



Café-Height Stool (Wood Back)
Footrest, Arms

H4079



Café-Height Stool (Upholstered Back)
Footrest, Arms

| CASTERS | CODE | DESCRIPTION | PRICE |
|---|----------|-------------|--------------|
|  | H | Hard Caster | +\$0 |
|  | S | Soft Caster | +\$20 |

*Specify for models H4075 and H4077 only

| FINISH | CODE | DESCRIPTION | PRICE |
|---------------|----------|----------------|-------------|
| | C | Harvest | +\$0 |
| | D | Natural Maple | +\$0 |
| | F | Shaker Cherry | +\$0 |
| | H | Bourbon Cherry | +\$0 |
| | N | Mahogany | +\$0 |

*Specify for models H4091, H4093, H4095, H4097 and H4099 only

| FRAME | CODE | DESCRIPTION | PRICE |
|--------------|-----------|-------------------|-------------|
| | T | Black | +\$0 |
| | T1 | Platinum Metallic | +\$0 |

HON BRANDED FABRICS

GRADE 1

Attire
Centurion
Compass
Contourette Polyurethane
Dapper
Hamilton
Inertia
Optic

GRADE 2

Appoint Seating
Clyde
Dotty
Rush
Seed
Spin Seating
Whisper Vinyl

GRADE 3

In Season
Purl
Silvertex™ Vinyl

For a complete list of fabrics, including partnership fabrics, go to hon.com/fabricsandfinishes.

**Pagoda™ wood back models available in Harvest (C), Natural Maple (D), Shaker Cherry (F), Bourbon Cherry (H) and Mahogany (N) only.

Reference Fabric Color Combinations on pages 20-24 for color codes and legend on page 21 for lead times. For additional HON to Supply COM fabric grade pricing, go to honready.hon.com and click on the HON to Supply COM link.

 For Fire Code model, availability and ordering method, refer to pages 28-31. Available on select models, contact HON Customer Support for availability.

PAGODA® 4070 Series

GSA SIN 711-19



Icon Legend on page 17

H4071



STACKING ARM GUEST CHAIRS

Set of Two

DIMENSIONS

| | | | |
|--------------|-----|-----------------------|----------|
| Depth: | 22½ | Arm Width: | 23¾ |
| Width: | 27¼ | Seat to Floor Height: | 18 |
| Height: | 33 | Usable Seat Depth: | 16¾ |
| Seat Depth: | 19¾ | Ship Weight: | 56 |
| Seat Width: | 20¼ | Cube: | 19.6 |
| Back Width: | 21¼ | COM: | 2.0 |
| Back Height: | 16¼ | Weight Rating: | 250 lbs. |

FABRIC PRICE CODES

| | Per Carton List Price | Single Unit List Price |
|----|--------------------------|---------------------------|
| 1 | \$831 | \$415.50 |
| 2 | \$879 | \$439.50 |
| 3 | \$927 | \$463.50 |
| 4 | \$963 | \$481.50 |
| 5 | \$999 | \$499.50 |
| 6 | \$1035 | \$517.50 |
| 7 | \$1071 | \$535.50 |
| 8 | \$1107 | \$553.50 |
| 9 | \$1143 | \$571.50 |
| 10 | \$1179 | \$589.50 |
| 11 | \$1215 | \$607.50 |
| 12 | \$1251 | \$625.50 |
| L | — | — |

NOTES: Use Model H4069 Ganging Connectors on page 214. Ships two to a container. See shipping notes on page 211.

H4073



STACKING ARMLESS GUEST CHAIRS

Set of Two

DIMENSIONS

| | | | |
|--------------|-----|-----------------------|----------|
| Depth: | 22½ | Seat to Floor Height: | 18 |
| Width: | 21¼ | Usable Seat Depth: | 16¾ |
| Height: | 33 | Ship Weight: | 52 |
| Seat Depth: | 19¾ | Cube: | 18.9 |
| Seat Width: | 20¼ | COM: | 2.0 |
| Back Width: | 21¼ | Weight Rating: | 250 lbs. |
| Back Height: | 16¼ | | |

FABRIC PRICE CODES

| | Per Carton List Price | Single Unit List Price |
|----|--------------------------|---------------------------|
| 1 | \$775 | \$387.50 |
| 2 | \$823 | \$411.50 |
| 3 | \$871 | \$435.50 |
| 4 | \$907 | \$453.50 |
| 5 | \$943 | \$471.50 |
| 6 | \$979 | \$489.50 |
| 7 | \$1015 | \$507.50 |
| 8 | \$1051 | \$525.50 |
| 9 | \$1087 | \$543.50 |
| 10 | \$1123 | \$561.50 |
| 11 | \$1159 | \$579.50 |
| 12 | \$1195 | \$597.50 |
| L | — | — |

NOTES: Use Model H4069 Ganging Connectors on page 214. Ships two to a container. See shipping notes on page 211.

HOW TO SPECIFY

| | | |
|--|---|--|
| Select Model Number <div style="border: 1px solid black; display: inline-block; padding: 2px;">H4071</div> | Select Fabric See page 209 <div style="border: 1px solid black; display: inline-block; padding: 2px;">CU10</div> | Select Frame T Black T1 Platinum Metallic <div style="border: 1px solid black; display: inline-block; padding: 2px;">T</div> |
|--|---|--|



Icon Legend on page 17

PAGODA® 4070 Series

H4075



STACKING ARM GUEST CHAIRS

Set of Two

DIMENSIONS

| | | | |
|--------------|-----|-----------------------|----------|
| Depth: | 22½ | Arm Width: | 23¾ |
| Width: | 27¼ | Seat to Floor Height: | 18 |
| Height: | 33 | Usable Seat Depth: | 16¾ |
| Seat Depth: | 19¾ | Ship Weight: | 56 |
| Seat Width: | 20¼ | Cube: | 19.6 |
| Back Width: | 21¼ | COM: | 2.0 |
| Back Height: | 16¼ | Weight Rating: | 250 lbs. |

FABRIC PRICE CODES

| | Per Carton List Price | Single Unit List Price |
|----|--------------------------|---------------------------|
| 1 | \$931 | \$465.50 |
| 2 | \$979 | \$489.50 |
| 3 | \$1027 | \$513.50 |
| 4 | \$1063 | \$531.50 |
| 5 | \$1099 | \$549.50 |
| 6 | \$1135 | \$567.50 |
| 7 | \$1171 | \$585.50 |
| 8 | \$1207 | \$603.50 |
| 9 | \$1243 | \$621.50 |
| 10 | \$1279 | \$639.50 |
| 11 | \$1315 | \$657.50 |
| 12 | \$1351 | \$675.50 |
| L | — | — |

H4077



MOBILE STACKING ARMLESS GUEST CHAIRS

Set of Two

DIMENSIONS

| | | | |
|--------------|-----|-----------------------|----------|
| Depth: | 22½ | Seat to Floor Height: | 18 |
| Width: | 21¼ | Usable Seat Depth: | 16¾ |
| Height: | 33 | Ship Weight: | 56 |
| Seat Depth: | 19¾ | Cube: | 19.5 |
| Seat Width: | 20¼ | COM: | 2.0 |
| Back Width: | 21¼ | Weight Rating: | 250 lbs. |
| Back Height: | 16¼ | | |

FABRIC PRICE CODES

| | Per Carton List Price | Single Unit List Price |
|----|--------------------------|---------------------------|
| 1 | \$876 | \$438.00 |
| 2 | \$924 | \$462.00 |
| 3 | \$972 | \$486.00 |
| 4 | \$1008 | \$504.00 |
| 5 | \$1044 | \$522.00 |
| 6 | \$1080 | \$540.00 |
| 7 | \$1116 | \$558.00 |
| 8 | \$1152 | \$576.00 |
| 9 | \$1188 | \$594.00 |
| 10 | \$1224 | \$612.00 |
| 11 | \$1260 | \$630.00 |
| 12 | \$1296 | \$648.00 |
| L | — | — |

ⓘ 4070 Series is ordered and shipped two (2) chairs per carton. Pricing shown is per carton. Each set of two (one carton), must have the same fabric/frame color. (COM yardage shown is for two chairs.) Ordering 2 of any model will result in 2 cartons being shipped, giving you 4 chairs.

HOW TO SPECIFY

| | | | |
|--|---|--|---|
| <p>Select Model Number</p> <p>H 4 0 7 5 .</p> | <p>Select Caster</p> <p>H Hard Caster S Soft Caster (+ \$20) <i>Specify for models H4075 and H4077 only</i></p> <p>H .</p> | <p>Select Fabric</p> <p>See page 209</p> <p>C U 1 0 .</p> | <p>Select Frame</p> <p>T Black T1 Platinum Metallic</p> <p>T</p> |
|--|---|--|---|

PAGODA® 4090 Series

GSA SIN 711-19



Icon Legend on page 17

H4091



STACKING ARM GUEST CHAIRS

Wood Back
Set of Two

DIMENSIONS

| | | | |
|--------------|-----|-----------------------|----------|
| Depth: | 22½ | Arm Width: | 23¾ |
| Width: | 27¼ | Seat to Floor Height: | 18 |
| Height: | 32½ | Usable Seat Depth: | 16¾ |
| Seat Depth: | 19¾ | Ship Weight: | 51 |
| Seat Width: | 20¼ | Cube: | 19.6 |
| Back Width: | 21¼ | COM: | 1.0 |
| Back Height: | 16¼ | Weight Rating: | 250 lbs. |

FABRIC PRICE CODES

| | Per Carton List Price | Single Unit List Price |
|----|--------------------------|---------------------------|
| 1 | \$966 | \$483.00 |
| 2 | \$990 | \$495.00 |
| 3 | \$1014 | \$507.00 |
| 4 | \$1032 | \$516.00 |
| 5 | \$1050 | \$525.00 |
| 6 | \$1068 | \$534.00 |
| 7 | \$1086 | \$543.00 |
| 8 | \$1104 | \$552.00 |
| 9 | \$1122 | \$561.00 |
| 10 | \$1140 | \$570.00 |
| 11 | \$1158 | \$579.00 |
| 12 | \$1176 | \$588.00 |
| L | — | — |

NOTES: Use Model H4069 Ganging Connectors on page 214.

! Ships two per carton. See note on page 213 for ordering.

H4093



STACKING ARMLESS GUEST CHAIRS

Wood Back
Set of Two

DIMENSIONS

| | | | |
|--------------|-----|-----------------------|----------|
| Depth: | 22½ | Seat to Floor Height: | 18 |
| Width: | 21¼ | Usable Seat Depth: | 16¾ |
| Height: | 32½ | Ship Weight: | 49 |
| Seat Depth: | 19¾ | Cube: | 18.9 |
| Seat Width: | 20¼ | COM: | 1.0 |
| Back Width: | 20½ | Weight Rating: | 250 lbs. |
| Back Height: | 16¼ | | |

FABRIC PRICE CODES

| | Per Carton List Price | Single Unit List Price |
|----|--------------------------|---------------------------|
| 1 | \$911 | \$455.50 |
| 2 | \$935 | \$467.50 |
| 3 | \$959 | \$479.50 |
| 4 | \$977 | \$488.50 |
| 5 | \$995 | \$497.50 |
| 6 | \$1013 | \$506.50 |
| 7 | \$1031 | \$515.50 |
| 8 | \$1049 | \$524.50 |
| 9 | \$1067 | \$533.50 |
| 10 | \$1085 | \$542.50 |
| 11 | \$1103 | \$551.50 |
| 12 | \$1121 | \$560.50 |
| L | — | — |

NOTES: Use Model H4069 Ganging Connectors on page 214.

! Ships two per carton. See note on page 213 for ordering.

! Pagoda® wood back models available in Harvest (C), Natural Maple (D), Shaker Cherry (F), Bourbon Cherry (H) and Mahogany (N) only.

HOW TO SPECIFY

| | | | |
|---|---|---|---|
| Select Model Number H 4 0 9 1 . | Select Finish Color See page 209 H . | Select Fabric See page 209 C U 1 0 . | Select Frame T Black T1 Platinum Metallic T |
|---|---|---|---|



PAGODA® 4090 Series

H4095



STACKING ARM GUEST CHAIRS

Wood Back
Set of Two

DIMENSIONS

| | | | |
|--------------|-----|-----------------------|----------|
| Depth: | 22½ | Arm Width: | 23¾ |
| Width: | 27¼ | Seat to Floor Height: | 18 |
| Height: | 32½ | Usable Seat Depth: | 16¾ |
| Seat Depth: | 19¾ | Ship Weight: | 53 |
| Seat Width: | 20¼ | Cube: | 19.6 |
| Back Width: | 20½ | COM: | 1.0 |
| Back Height: | 16¼ | Weight Rating: | 250 lbs. |

FABRIC PRICE CODES

| | Per Carton List Price | Single Unit List Price |
|----|--------------------------|---------------------------|
| 1 | \$1067 | \$533.50 |
| 2 | \$1091 | \$545.50 |
| 3 | \$1115 | \$557.50 |
| 4 | \$1133 | \$566.50 |
| 5 | \$1151 | \$575.50 |
| 6 | \$1169 | \$584.50 |
| 7 | \$1187 | \$593.50 |
| 8 | \$1205 | \$602.50 |
| 9 | \$1223 | \$611.50 |
| 10 | \$1241 | \$620.50 |
| 11 | \$1259 | \$629.50 |
| 12 | \$1277 | \$638.50 |
| L | — | — |

! Ships two per carton. See note below for ordering.

H4097



MOBILE STACKING ARMLESS GUEST CHAIRS

Wood Back
Set of Two

DIMENSIONS

| | | | |
|--------------|-----|-----------------------|----------|
| Depth: | 22½ | Seat to Floor Height: | 18 |
| Width: | 21¼ | Usable Seat Depth: | 16¾ |
| Height: | 32½ | Ship Weight: | 51 |
| Seat Depth: | 19¾ | Cube: | 19.6 |
| Seat Width: | 20¼ | COM: | 1.0 |
| Back Width: | 20½ | Weight Rating: | 250 lbs. |
| Back Height: | 16¼ | | |

FABRIC PRICE CODES

| | Per Carton List Price | Single Unit List Price |
|----|--------------------------|---------------------------|
| 1 | \$1012 | \$506.00 |
| 2 | \$1036 | \$518.00 |
| 3 | \$1060 | \$530.00 |
| 4 | \$1078 | \$539.00 |
| 5 | \$1096 | \$548.00 |
| 6 | \$1114 | \$557.00 |
| 7 | \$1132 | \$566.00 |
| 8 | \$1150 | \$575.00 |
| 9 | \$1168 | \$584.00 |
| 10 | \$1186 | \$593.00 |
| 11 | \$1204 | \$602.00 |
| 12 | \$1222 | \$611.00 |
| L | — | — |

! Ships two per carton. See note below for ordering.

- 2 4090 Series is ordered and shipped two (2) chairs per carton. Pricing shown is per carton. Each set of two (one carton), must have the same fabric/frame color. (COM yardage shown is for two chairs.) Ordering 2 of any model will result in 2 cartons being shipped, giving you 4 chairs.
- ! Pagoda® wood back models available in Harvest (C), Natural Maple (D), Shaker Cherry (F), Bourbon Cherry (H) and Mahogany (N) only.

HOW TO SPECIFY

| | | | |
|--|--|--|---|
| <p>Select Model Number</p> <p style="text-align: center;">H 4 0 9 5 .</p> | <p>Select Finish Color</p> <p style="text-align: center;">See page 209</p> <p style="text-align: center;">H .</p> | <p>Select Fabric</p> <p style="text-align: center;">See page 209</p> <p style="text-align: center;">C U 1 0 .</p> | <p>Select Frame</p> <p>T Black TI Platinum Metallic</p> <p style="text-align: center;">T</p> |
|--|--|--|---|

PAGODA® 4070/4090 Series

GSA SIN 711-19



Icon Legend on page 17

H4099

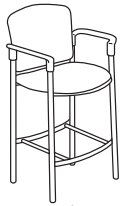

CAFÉ-HEIGHT STOOL

Wood Back
Footrest
Arms

DIMENSIONS

| | | | |
|--------------|-----|-----------------------|----------|
| Depth: | 22½ | Arm Width: | 23¾ |
| Width: | 27¼ | Seat to Floor Height: | 29⅝ |
| Height: | 44⅞ | Usable Seat Depth: | 16¾ |
| Seat Depth: | 19¾ | Ship Weight: | 34 |
| Seat Width: | 20¼ | Cube: | 19.3 |
| Back Width: | 20½ | COM: | 1.0 |
| Back Height: | 16¼ | Weight Rating: | 250 lbs. |

FABRIC PRICE CODES

Single Unit List Price

| | |
|----|----------|
| 1 | \$622.00 |
| 2 | \$646.00 |
| 3 | \$670.00 |
| 4 | \$688.00 |
| 5 | \$706.00 |
| 6 | \$724.00 |
| 7 | \$742.00 |
| 8 | \$760.00 |
| 9 | \$778.00 |
| 10 | \$796.00 |
| 11 | \$814.00 |
| 12 | \$832.00 |
| L | — |

NOTES: Model H4099 is ordered and shipped one (1) per carton.

H4079

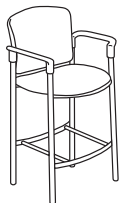

CAFÉ-HEIGHT STOOL

Upholstered Back
Footrest
Arms

DIMENSIONS

| | | | |
|--------------|-----|-----------------------|----------|
| Depth: | 22½ | Arm Width: | 23¾ |
| Width: | 27¼ | Seat to Floor Height: | 29⅝ |
| Height: | 44⅞ | Usable Seat Depth: | 16¾ |
| Seat Depth: | 19¾ | Ship Weight: | 39 |
| Seat Width: | 20¼ | Cube: | 19.3 |
| Back Width: | 21¼ | COM: | 2.0 |
| Back Height: | 16¼ | Weight Rating: | 250 lbs. |

FABRIC PRICE CODES

Single Unit List Price

| | |
|----|----------|
| 1 | \$542.00 |
| 2 | \$590.00 |
| 3 | \$638.00 |
| 4 | \$674.00 |
| 5 | \$710.00 |
| 6 | \$746.00 |
| 7 | \$782.00 |
| 8 | \$818.00 |
| 9 | \$854.00 |
| 10 | \$890.00 |
| 11 | \$926.00 |
| 12 | \$962.00 |
| L | — |

NOTES: Upholstered back. Model H4079 is ordered and shipped one (1) per carton.

H4069



GANGING CONNECTORS

(hardware included)

DIMENSIONS

| | |
|--------------|------|
| Ship Weight: | 2 Ⓞ |
| Cube: | 0.05 |

LIST PRICE

\$59.00

NOTES: Specify Chairs frame color: Black (T)

ⓘ For use on models H4071, H4073, H4091 and H4093.

HUCART

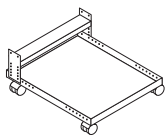

UNIVERSAL 4-LEG CHAIR CART

DIMENSIONS

| | | | |
|---------|----|--------------|------|
| Depth: | 22 | Ship Weight: | 24 Ⓞ |
| Width: | 22 | Cube: | 2.0 |
| Height: | 8 | | |

LIST PRICE

\$374.00

NOTES: Steel frame construction. 4 casters — 2 locking, 2 non-locking.

ⓘ For use with models H4071, H4073, H4075, H4077. Black only.

HOW TO SPECIFY

| | | | |
|--|---|---|---|
| <p>Select Model Number</p> <p>See page 209</p> <p><i>Specify for model H4099 only</i></p> <p>H 4 0 7 9 .</p> <p>H 4 0 9 9 .</p> | <p>Select Finish Color</p> <p>See page 209</p> <p><i>Specify for model H4099 only</i></p> <p>H .</p> | <p>Select Fabric</p> <p>See page 209</p> <p>C U 1 0 .</p> <p>C U 1 0 .</p> | <p>Select Frame</p> <p>T Black</p> <p>T1 Platinum Metallic</p> <p>T</p> <p>T</p> |
|--|---|---|---|

PARK AVENUE COLLECTION® 5000 SERIES



Park Avenue Collection Executive High-Back Chair shown with Park Avenue Collection Laminate desks.

PARK AVENUE COLLECTION® 5000 SERIES

Park Avenue seating is your address for elegance. This family of task and guest seating features all-day comfort with upscale accents. Task chairs feature a choice of Polished Aluminum or Black frame with inlaid wood accents, as well as an elegant tuxedo back design that creates a sophisticated look. Guest seating welcomes visitors in style and leaves a lasting impression. If you're looking to put yourself, your coworkers and your visitors at ease, make a move to Park Avenue.



GUEST CHAIR FEATURES

- Fully-upholstered outer back.
- Backs feature sewn seams for a tailored look.
- Solid hardwood in one of eight attractive finishes.
- Warranted for users up to 275 lbs.

TASK CHAIR FEATURES

- Mid-range knee-tilt mechanism allows for a natural, comfortable recline.
- Pneumatic seat height adjustment moves the seat up and down to adapt to various body heights.
- Tilt tension controls the rate and ease of recline.
- Tilt lock allows the user to lock out the tilt function.
- Arms feature a urethane top pad.
- Base features a steel substrate with hardwood base caps.
- Warranted for users up to 275 lbs.

PARK AVENUE COLLECTION®

5000 Series Options

MODEL OPTIONS

H5001



Executive High-Back

Pneumatic, Swivel, Mid-range
Knee Tilt, Tilt Tension, Tilt Lock,
Open Loop Arms

H5002



Managerial Mid-Back

Pneumatic, Swivel, Mid-range
Knee Tilt, Tilt Tension, Tilt Lock,
Open Loop Arms

H5003



Guest Chair

Leg Base, Wood Arms

AVAILABLE FINISHES

Park Avenue Collection® 5000 Series
Seating is available in 8 wood finishes.

WOOD FINISHES

Bourbon Cherry (H)

Cognac (COGN)

Harvest (C)

Mahogany (N)

Mocha (MOCH)

Natural Maple (D)

Pinnacle (PINC)

Shaker Cherry (F)

HON BRANDED FABRICS

GRADE 1

Centurion
Compass
Contourette Polyurethane
Dapper
Hamilton
Inertia
Optic

GRADE 2

Appoint Seating
Clyde
Dotty
Rush
Seed
Spin Seating
Whisper Vinyl

GRADE 3

Purl
Silvertext™ Vinyl

GRADE L

Denver Leather

For a complete list of fabrics, including partnership fabrics, go to hon.com/fabricsandfinishes.

Reference Fabric Color Combinations on pages 20-24 for color codes and legend on page 21 for lead times. For additional HON to Supply COM fabric grade pricing, go to honready.hon.com and click on the HON to Supply COM link.

🔥 For Fire Code model, availability and ordering method, refer to pages 28-31. Available on select models, contact HON Customer Support for availability.



PARK AVENUE COLLECTION®

5000 Series

H5001



EXECUTIVE HIGH-BACK

Pneumatic
Swivel
Mid-range Knee Tilt
Tilt Tension
Tilt Lock
Open Loop Arms

Functions: **A, E, G, K, L**
(Function Key on pages 18-19)

DIMENSIONS

| | | | |
|--------------|--------------------------------|-----------------------|--|
| Depth: | 29 | Arm Width: | 20 |
| Width: | 26 | Seat to Floor Height: | 17 ³ / ₄ -22 ¹ / ₂ |
| Height: | 44 ¹ / ₂ | Usable Seat Depth: | 17 ⁵ / ₈ |
| Seat Depth: | 19 ¹ / ₂ | Ship Weight: | 61 |
| Seat Width: | 20 | Cube: | 23.7 |
| Back Width: | 20 | COM: | 3.0 |
| Back Height: | 26 ¹ / ₄ | Weight Rating: | 250 lbs. |

FABRIC PRICE CODES

| | | | |
|---|--------|----|--------|
| 1 | \$968 | 8 | \$1382 |
| 2 | \$1040 | 9 | \$1436 |
| 3 | \$1112 | 10 | \$1490 |
| 4 | \$1166 | 11 | \$1544 |
| 5 | \$1220 | 12 | \$1598 |
| 6 | \$1274 | L | \$1568 |
| 7 | \$1328 | | |

NOTES: Arms are selected hardwood with urethane top pads.

H5002



MANAGERIAL MID-BACK

Pneumatic
Swivel
Mid-range Knee Tilt
Tilt Lock
Open Loop Arms

Functions: **A, E, G, K, L**
(Function Key on pages 18-19)

DIMENSIONS

| | | | |
|--------------|--------------------------------|-----------------------|--|
| Depth: | 29 | Arm Width: | 20 |
| Width: | 26 | Seat to Floor Height: | 17 ³ / ₄ -22 ¹ / ₂ |
| Height: | 39 ¹ / ₂ | Usable Seat Depth: | 17 ⁵ / ₈ |
| Seat Depth: | 19 ¹ / ₂ | Ship Weight: | 57 |
| Seat Width: | 20 | Cube: | 18.5 |
| Back Width: | 20 | COM: | 2.5 |
| Back Height: | 19 ¹ / ₄ | Weight Rating: | 250 lbs. |

FABRIC PRICE CODES

| | | | |
|---|--------|----|--------|
| 1 | \$943 | 8 | \$1288 |
| 2 | \$1003 | 9 | \$1333 |
| 3 | \$1063 | 10 | \$1378 |
| 4 | \$1108 | 11 | \$1423 |
| 5 | \$1153 | 12 | \$1468 |
| 6 | \$1198 | L | \$1443 |
| 7 | \$1243 | | |

NOTES: Arms are selected hardwood with urethane top pads.

H5003



GUEST CHAIR

Leg Base
Wood Arms

DIMENSIONS

| | | | |
|--------------|--------------------------------|-----------------------|--------------------------------|
| Depth: | 22 | Arm Width: | 19 |
| Width: | 23 ¹ / ₂ | Seat to Floor Height: | 18 ¹ / ₂ |
| Height: | 33 ⁵ / ₈ | Usable Seat Depth: | 17 |
| Seat Depth: | 17 | Ship Weight: | 27 |
| Seat Width: | 20 | Cube: | 15.0 |
| Back Width: | 21 | COM: | 1.5 |
| Back Height: | 17 | Weight Rating: | 250 lbs. |

FABRIC PRICE CODES

| | | | |
|---|-------|----|-------|
| 1 | \$676 | 8 | \$883 |
| 2 | \$712 | 9 | \$910 |
| 3 | \$748 | 10 | \$937 |
| 4 | \$775 | 11 | \$964 |
| 5 | \$802 | 12 | \$991 |
| 6 | \$829 | L | \$976 |
| 7 | \$856 | | |

NOTES: Arms are selected hardwood with no urethane top pad.

HON Recommendation: H5001.MOCH.CU__ - List Price \$968

HOW TO SPECIFY

Select
Model Number

H5001

Select
Finish

See page 216

MOCH

Select
Fabric

See page 216

CU10

CENTERPIECE™ Occasional Tables

OPEN MARKET



Icon Legend on page 17

HVPTO2448L16 COFFEE TABLE

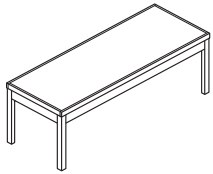

DIMENSIONS

| | | | |
|---------|----|--------------|------|
| Length: | 48 | Ship Weight: | 51 |
| Width: | 24 | Cube: | 15.1 |
| Height: | 16 | | |

LIST PRICE

\$1540

NOTES: Selection features a coffee table and two side tables. Legs are constructed of solid hardwood. Legs are attached to table with steel corner brackets and lag bolts. Metal tack glides are standard. Legs require customer attachment.

HVPTO2424L16 IN-LINE TABLE

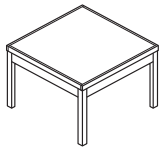

DIMENSIONS

| | | | |
|---------|----|--------------|-----|
| Length: | 24 | Ship Weight: | 30 |
| Width: | 24 | Cube: | 8.0 |
| Height: | 16 | | |

LIST PRICE

\$1248

NOTES: Selection features a coffee table and two side tables. Legs are constructed of solid hardwood. Legs are attached to table with steel corner brackets and lag bolts. Metal tack glides are standard. Legs require customer attachment.

HVPTO2424L21 END TABLE

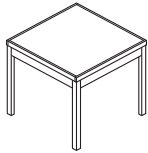

DIMENSIONS

| | | | |
|---------|----|--------------|------|
| Length: | 24 | Ship Weight: | 41 |
| Width: | 24 | Cube: | 10.1 |
| Height: | 21 | | |

LIST PRICE

\$1320

NOTES: Selection features a coffee table and two side tables. Legs are constructed of solid hardwood. Legs are attached to table with steel corner brackets and lag bolts. Metal tack glides are standard. Legs require customer attachment.

HON Recommendation: HVPTO2424L16.N - List Price \$1248

HOW TO SPECIFY

Select
Model Number

Select
Finish

See page 216

H V P T O 2 4 2 4 L 1 6 .

N

PARK AVENUE COLLECTION® 5020 SERIES



Park Avenue Mid-Back Chairs shown with Preside® Conference Table.

PARK AVENUE COLLECTION® 5020 SERIES

Park Avenue seating is your address for elegance. This family of task and guest seating features all-day comfort with upscale accents. Task chairs feature a Polished Aluminum base, as well as an elegant tuxedo back design that creates a sophisticated look. Guest seating welcomes visitors in style and leaves a lasting impression. If you're looking to put yourself, your coworkers and your visitors at ease, make a move to Park Avenue.



GUEST CHAIR FEATURES

- Fully-upholstered outer back.
- Backs feature sewn seams for a tailored look.
- Black powder coated frame.
- Warranted for users up to 275 lbs.

TASK CHAIR FEATURES

- Mid-range knee-tilt mechanism allows for a natural, comfortable recline.
- Pneumatic seat height adjustment moves the seat up and down to adapt to various body heights.
- Tilt tension controls the rate and ease of recline.
- Tilt lock allows the user to lock out the tilt function.
- Arms feature a urethane top pad.
- Polished Aluminum base.
- Warranted for users up to 275 lbs.

PARK AVENUE COLLECTION®

5020 Series Options

MODEL OPTIONS

H5021



Executive High-Back

Pneumatic, Swivel, Mid-range Knee Tilt, Tilt Tension, Tilt Lock, Open Loop Arms

H5022



Managerial Mid-Back

Pneumatic, Swivel, Mid-range Knee Tilt, Tilt Tension, Tilt Lock, Open Loop Arms

H5023



Guest Chair

Sled Base, Arms

CASTERS



| CODE | DESCRIPTION | PRICE |
|----------|-------------|-------------|
| H | Hard Caster | +\$0 |



| | | |
|----------|-------------|--------------|
| S | Soft Caster | +\$30 |
|----------|-------------|--------------|

*Specify for models H5021 and H5022 only

HON BRANDED FABRICS

GRADE 1

Attire
Centurion
Compass
Contourette Polyurethane
Dapper
Hamilton
Inertia
Optic

GRADE 2

Appoint Seating
Clyde
Dotty
Rush
Seed
Spin Seating
Whisper Vinyl

GRADE 3

Purl
Silvertex™ Vinyl

GRADE L

Denver Leather

For a complete list of fabrics, including partnership fabrics, go to hon.com/fabricsandfinishes.

Reference Fabric Color Combinations on pages 20-24 for color codes and legend on page 21 for lead times. For additional HON to Supply COM fabric grade pricing, go to honready.hon.com and click on the HON to Supply COM link.

For Fire Code model, availability and ordering method, refer to pages 28-31. Available on select models, contact HON Customer Support for availability.



PARK AVENUE COLLECTION®

5020 Series

H5021



EXECUTIVE HIGH-BACK

Pneumatic
Swivel
Mid-range Knee Tilt
Tilt Tension
Tilt Lock
Open Loop Arms
Functions: **A, E, G, K, L**
(Function Key on pages 18-19)

DIMENSIONS

| | | | |
|--------------|--------------------------------|-----------------------|--|
| Depth: | 29 | Arm Width: | 20 |
| Width: | 26 | Seat to Floor Height: | 17 ³ / ₄ -22 ¹ / ₂ |
| Height: | 44 ¹ / ₂ | Usable Seat Depth: | 17 ⁵ / ₈ |
| Seat Depth: | 17 ⁵ / ₈ | Ship Weight: | 57 |
| Seat Width: | 20 | Cube: | 16.0 |
| Back Width: | 20 | COM: | 3.0 |
| Back Height: | 26 ¹ / ₄ | Weight Rating: | 250 lbs. |

FABRIC PRICE CODES

| | | | |
|---|--------|----|--------|
| 1 | \$1057 | 8 | \$1471 |
| 2 | \$1129 | 9 | \$1525 |
| 3 | \$1201 | 10 | \$1579 |
| 4 | \$1255 | 11 | \$1633 |
| 5 | \$1309 | 12 | \$1687 |
| 6 | \$1363 | L | \$1657 |
| 7 | \$1417 | | |

Polished aluminum base

H5022



MANAGERIAL MID-BACK

Pneumatic
Swivel
Mid-range Knee Tilt
Tilt Tension
Tilt Lock
Open Loop Arms
Functions: **A, E, G, K, L**
(Function Key on pages 18-19)

DIMENSIONS

| | | | |
|--------------|--------------------------------|-----------------------|--|
| Depth: | 29 | Arm Width: | 20 |
| Width: | 26 | Seat to Floor Height: | 17 ³ / ₄ -22 ¹ / ₂ |
| Height: | 38 ¹ / ₂ | Usable Seat Depth: | 17 ⁵ / ₈ |
| Seat Depth: | 17 ⁵ / ₈ | Ship Weight: | 54 |
| Seat Width: | 20 | Cube: | 16.0 |
| Back Width: | 20 | COM: | 2.5 |
| Back Height: | 19 ¹ / ₄ | Weight Rating: | 250 lbs. |

FABRIC PRICE CODES

| | | | |
|---|--------|----|--------|
| 1 | \$1032 | 8 | \$1377 |
| 2 | \$1092 | 9 | \$1422 |
| 3 | \$1152 | 10 | \$1467 |
| 4 | \$1197 | 11 | \$1512 |
| 5 | \$1242 | 12 | \$1557 |
| 6 | \$1287 | L | \$1532 |
| 7 | \$1332 | | |

Polished aluminum base

H5023

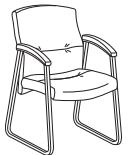

GUEST CHAIR

Sled Base
Arms

DIMENSIONS

| | | | |
|--------------|--------------------------------|-----------------------|--------------------------------|
| Depth: | 27 | Arm Width: | 20 |
| Width: | 25 | Seat to Floor Height: | 18 ¹ / ₂ |
| Height: | 35 ¹ / ₂ | Usable Seat Depth: | 17 ⁵ / ₈ |
| Seat Depth: | 17 ⁵ / ₈ | Ship Weight: | 45 |
| Seat Width: | 20 | Cube: | 18.4 |
| Back Width: | 20 | COM: | 2.5 |
| Back Height: | 19 ¹ / ₄ | Weight Rating: | 250 lbs. |

FABRIC PRICE CODES

| | | | |
|---|--------|----|--------|
| 1 | \$814 | 8 | \$1159 |
| 2 | \$874 | 9 | \$1204 |
| 3 | \$934 | 10 | \$1249 |
| 4 | \$979 | 11 | \$1294 |
| 5 | \$1024 | 12 | \$1339 |
| 6 | \$1069 | L | \$1314 |
| 7 | \$1114 | | |

Black powder coated frame



HON Recommendation: H5021.H.CU__ - List Price \$1057

HOW TO SPECIFY

| | | |
|--|---|--|
| <p>Select Model Number</p> <p>H 5 0 2 1 .</p> | <p>Select Caster</p> <p>H Hard Caster S Soft Caster (+ \$30) <i>Specify for models H5021 and H5022 only</i></p> <p>H .</p> | <p>Select Fabric</p> <p>See page 220</p> <p>C U 1 0</p> |
|--|---|--|

PERCH™ Active Seating

OPEN MARKET



Icon Legend on page 17

HVLPERCH



PERCH STOOL

Pneumatic
Swivel
Pivot Base

DIMENSIONS

| | | | |
|-------------|-----|-----------------------|-------------|
| Depth: | 16½ | Seat to Floor Height: | 23¾-35 |
| Width: | 15¾ | Usable Seat Depth: | 14½ |
| Seat Depth: | 14½ | Ship Weight: | 22 Ⓢ |
| Seat Width: | 14½ | Cube: | 3.13 |
| | | Weight Rating: | 250 lbs. |

PRICE CODE

Fabric **\$403**

NOTES: Fabric seat in Black, Charcoal, Red, Blue, and Green. Built-in handle. Active pivot base. Silver frame. **HON 5-Year Limited Warranty.**

HON Recommendation: HVLPERCH.ASF10.X - List Price \$403

HVL991

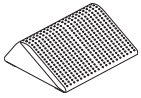

FOOTREST

Anti-Slip Cover

DIMENSIONS

| | | | |
|---------|-----|----------------|------------|
| Depth: | 13¾ | Ship Weight: | 7 Ⓢ |
| Width: | 16 | Cube: | 0.9 |
| Height: | 5½ | Weight Rating: | 250 lbs. |

LIST PRICE

\$66

! Available in Black (T) finish ONLY. **HON 5-Year Limited Warranty.**

SPECIFYING EXAMPLE: HVL991.T

HBEAFM1

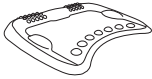

ANTI-FATIGUE MAT

Ergonomic

DIMENSIONS

| | | | |
|---------|-----|--------------|-----|
| Depth: | 25 | Ship Weight: | 7 |
| Width: | 29⅞ | Cube: | 1.4 |
| Height: | 2¾ | | |

LIST PRICE

\$178

! Available in Black ONLY. No specification needed. **HON 5-Year Limited Warranty.**

SPECIFYING EXAMPLE: HBEAFM1

HOW TO SPECIFY

| | | |
|--|--|---|
| <p>Select Model Number</p> <p>H V L P E R C H .</p> | <p>Select Fabric</p> <p>ASF10 Black Fabric ASF19 Charcoal Fabric ASF42 Red Fabric ASF90 Blue Fabric ASF82 Green Fabric</p> <p>A S F 1 0 .</p> | <p>Select Frame</p> <p>X Silver</p> <p>X</p> |
|--|--|---|

PERPETUAL[®] NESTING CHAIRS



Perpetual Nesting Chairs and Huddle[®] Tables.

PERPETUAL[®] NESTING CHAIRS

Always attractive, always supportive — that's Perpetual. Provide full-time comfort to even part-time workers with the Perpetual line of multi-purpose seating. The flip-up seat design maximizes space by allowing Perpetual to be easily nested. The passive back design moves with the user to deliver added comfort for all day meetings. Save space without sacrificing comfort with Perpetual.



FEATURES

- Flip-up seat allows chairs to nest and save floor space.
- Optional resilience knit back is breathable and supportive.
- Backrest reclines for added comfort.
- Tube rolled steel frame adds durability.
- Underside of seat is fully-upholstered for a clean appearance when nested.
- All-surface casters roll effortlessly and silently.
- Available in hundreds of quality HON fabrics.
- Warranted for users up to 300 lbs.

PERPETUAL[®] Nesting Chairs Options

MODEL OPTIONS

HPN1



Nesting Chair (Flex-back)

Armless, Four Legs

HPN2



Nesting Chair (Flex-back)

Fixed Arms, Four Legs

CASTER/ GLIDE



| CODE | DESCRIPTION | PRICE |
|------|-------------|--------------|
| A | All-surface | +\$0 |
| G | Bell Glide | +\$25 |

FRAME

| CODE | DESCRIPTION | PRICE |
|------|-------------------|-------------|
| T | Black | +\$0 |
| T1 | Platinum Metallic | +\$0 |

BACK STYLE



| CODE | DESCRIPTION | PRICE |
|------|-----------------------|-------------|
| UU | Upholstered Back | +\$0 |
| RB | Resilience Back/Black | +\$0 |
| RG | Resilience Back/Gray | +\$0 |

HON BRANDED FABRICS

GRADE 1

Attire
Centurion
Compass
Contourette Polyurethane
Dapper
Hamilton
Inertia
Optic

GRADE 2

Appoint Seating
Clyde
Dotty
Rush
Seed
Spin Seating
Whisper Vinyl

GRADE 3

Purl
Silvertext™ Vinyl

For a complete list of fabrics, including partnership fabrics, go to hon.com/fabricsandfinishes.

Reference Fabric Color Combinations on pages 20-24 for color codes and legend on page 21 for lead times. For additional HON to Supply COM fabric grade pricing, go to honready.hon.com and click on the HON to Supply COM link.

For Fire Code model, availability and ordering method, refer to pages 28-31. Available on select models, contact HON Customer Support for availability.



Icon Legend on page 17

PERPETUAL® Nesting Chairs

HPN1



Model HPN1AUU shown

NESTING CHAIR

Flex-back
Armless
Four Legs

DIMENSIONS

| | | | |
|--------------|------------------|-----------------------|------------------|
| Depth: | 26 | Seat to Floor Height: | 19 $\frac{1}{8}$ |
| Width: | 26 | Usable Seat Depth: | 16 $\frac{1}{2}$ |
| Height: | 36 | Ship Weight: | 38 |
| Seat Depth: | 17 $\frac{3}{4}$ | Cube: | 15.2 |
| Seat Width: | 17 | COM: | 1.5 |
| Back Width: | 17 $\frac{1}{2}$ | Weight Rating: | 300 lbs. |
| Back Height: | 15 $\frac{3}{4}$ | | |

FABRIC PRICE CODES

| | | | |
|---|-------|----|-------|
| 1 | \$610 | 8 | \$817 |
| 2 | \$646 | 9 | \$844 |
| 3 | \$682 | 10 | \$871 |
| 4 | \$709 | 11 | \$898 |
| 5 | \$736 | 12 | \$925 |
| 6 | \$763 | L | — |
| 7 | \$790 | | |

HPN1



Model HPN1ARB shown

NESTING CHAIR

Flex-back
Armless
Four Legs

DIMENSIONS

| | | | |
|--------------|------------------|-----------------------|------------------|
| Depth: | 25 $\frac{3}{4}$ | Seat to Floor Height: | 19 $\frac{1}{8}$ |
| Width: | 26 | Usable Seat Depth: | 16 $\frac{1}{2}$ |
| Height: | 35 $\frac{1}{4}$ | Ship Weight: | 36 |
| Seat Depth: | 17 $\frac{3}{4}$ | Cube: | 15.2 |
| Seat Width: | 17 | COM: | 1.0 |
| Back Width: | 19 $\frac{1}{4}$ | Weight Rating: | 300 lbs. |
| Back Height: | 16 $\frac{1}{2}$ | | |

FABRIC PRICE CODES

| | | | |
|---|-------|----|-------|
| 1 | \$610 | 8 | \$817 |
| 2 | \$646 | 9 | \$844 |
| 3 | \$682 | 10 | \$871 |
| 4 | \$709 | 11 | \$898 |
| 5 | \$736 | 12 | \$925 |
| 6 | \$763 | L | — |
| 7 | \$790 | | |

HPN2



Model HPN2AUU shown

NESTING CHAIR

Flex-back
Fixed Arms
Four Legs

DIMENSIONS

| | | | |
|--------------|------------------|-----------------------|------------------|
| Depth: | 26 | Arm Width: | 20 $\frac{3}{4}$ |
| Width: | 26 | Seat to Floor Height: | 19 $\frac{1}{8}$ |
| Height: | 36 | Usable Seat Depth: | 16 $\frac{1}{2}$ |
| Seat Depth: | 17 $\frac{3}{4}$ | Ship Weight: | 41 |
| Seat Width: | 17 | Cube: | 15.2 |
| Back Width: | 17 $\frac{1}{2}$ | COM: | 1.5 |
| Back Height: | 15 $\frac{3}{4}$ | Weight Rating: | 300 lbs. |

FABRIC PRICE CODES

| | | | |
|---|-------|----|-------|
| 1 | \$675 | 8 | \$882 |
| 2 | \$711 | 9 | \$909 |
| 3 | \$747 | 10 | \$936 |
| 4 | \$774 | 11 | \$963 |
| 5 | \$801 | 12 | \$990 |
| 6 | \$828 | L | — |
| 7 | \$855 | | |

HPN2



Model HPN2ARB shown

NESTING CHAIR

Flex-back
Fixed Arms
Four Legs

DIMENSIONS

| | | | |
|--------------|------------------|-----------------------|------------------|
| Depth: | 25 $\frac{3}{4}$ | Arm Width: | 20 $\frac{3}{4}$ |
| Width: | 26 | Seat to Floor Height: | 19 $\frac{1}{8}$ |
| Height: | 35 $\frac{1}{4}$ | Usable Seat Depth: | 16 $\frac{1}{2}$ |
| Seat Depth: | 17 $\frac{3}{4}$ | Ship Weight: | 38 |
| Seat Width: | 17 | Cube: | 15.2 |
| Back Width: | 19 $\frac{1}{4}$ | COM: | 1.0 |
| Back Height: | 16 $\frac{1}{2}$ | Weight Rating: | 300 lbs. |

FABRIC PRICE CODES

| | | | |
|---|-------|----|-------|
| 1 | \$675 | 8 | \$882 |
| 2 | \$711 | 9 | \$909 |
| 3 | \$747 | 10 | \$936 |
| 4 | \$774 | 11 | \$963 |
| 5 | \$801 | 12 | \$990 |
| 6 | \$828 | L | — |
| 7 | \$855 | | |

HOW TO SPECIFY

| | | | | |
|---|---|--|--|---|
| <p>Select Model Number</p> <p>HPN1</p> | <p>Select Caster/Glide</p> <p>A All-surface G Bell Glide (+ \$25)</p> <p>A</p> | <p>Select Back Type</p> <p>UU Upholstered Back RB Resilience Back/Black RG Resilience Back/Gray</p> <p>UU</p> | <p>Select Fabric</p> <p>Note: For models with upholstered back, seat and back are always matching fabric See page 224</p> <p>CU10</p> | <p>Select Frame</p> <p>T Black T1 Platinum Metallic</p> <p>T</p> |
|---|---|--|--|---|

PILLOW-SOFT® 2090 SERIES



Pillow-Soft High-Back Executive and Sled Base Guest Chairs shown with 10700 Series™ desks.

PILLOW-SOFT® 2090 SERIES

Pillow-Soft chairs combine comfort, style and selection to deliver the ultimate seating experience. Each executive chair in the collection combines thick memory foam cushioning with built-in lumbar support to reduce fatigue and increase comfort. Besides the full body support, it adds an authoritative presence to the office. The plush tufted leather or fabric will add a touch of sophistication to your office.



FEATURES

- Responsive memory foam eliminates pressure points and provides lasting comfort.
- Loop arms relieve stress on the shoulder and neck.
- Fully-upholstered outer back.
- Memory foam seat cushion reduces pressure points and responds to contours of the body for lasting comfort.
- Task chairs come standard with pneumatic seat height adjustment, tilt, tilt tension and tilt lock.
- Dual-wheel, hooded casters roll effortlessly and silently.
- Warranted for users up to 300 lbs.

PILLOW-SOFT® 2090 Series Options

MODEL OPTIONS

H2091



Executive High-Back

Pneumatic, Swivel, Tilt, Tilt Tension, Tilt Lock, Arms

H2095



Executive High-Back

Pneumatic, Swivel, Tilt, Tilt Tension, Tilt Lock, Arms

H2092



Managerial Mid-Back

Pneumatic, Swivel, Tilt, Tilt Tension, Tilt Lock, Arms

H2093



Guest Chair

Sled Base, Arms

CASTERS



| CODE | DESCRIPTION | PRICE |
|----------|-------------|--------------|
| H | Hard Caster | + \$0 |



| | | |
|----------|-------------|---------------|
| S | Soft Caster | + \$30 |
|----------|-------------|---------------|

HON BRANDED FABRICS

GRADE 1

Black Vinyl
Burgundy Vinyl
Centurion
Compass
Contourette Polyurethane
Dapper
Hamilton
Inertia
Optic

GRADE 2

Appoint Seating
Clyde
Dotty
Rush
Seed
Spin Seating
Whisper Vinyl

GRADE 3

Purl
Silvertext™ Vinyl

For a complete list of fabrics, including partnership fabrics, go to hon.com/fabricsandfinishes.

Reference Fabric Color Combinations on pages 20-24 for color codes and legend on page 21 for lead times. For additional HON to Supply COM fabric grade pricing, go to honready.hon.com and click on the HON to Supply COM link.

🔥 For Fire Code model, availability and ordering method, refer to pages 28-31. Available on select models, contact HON Customer Support for availability.

PILLOW-SOFT® 2090 Series

GSA SIN 711-18 EXCEPT AS NOTED



Icon Legend on page 17

H2091



EXECUTIVE HIGH-BACK

Pneumatic
Swivel
Tilt
Tilt Tension
Tilt Lock
Arms
Functions: **A, E, F, K, L**
(Function Key on pages 18-19)

DIMENSIONS

| | | | |
|--------------|-----|-----------------------|----------|
| Depth: | 29¾ | Arm Width: | 20¼ |
| Width: | 26¼ | Seat to Floor Height: | 16¾-21¼ |
| Height: | 46½ | Usable Seat Depth: | 18½ |
| Seat Depth: | 21 | Ship Weight: | 57 |
| Seat Width: | 22 | Cube: | 16.0 |
| Back Width: | 22 | COM: | 3.0 |
| Back Height: | 25 | Weight Rating: | 300 lbs. |

FABRIC PRICE CODES

| | | | |
|----------|--------------|-----------|---------------|
| 1 | \$585 | 8 | \$999 |
| 2 | \$657 | 9 | \$1053 |
| 3 | \$729 | 10 | \$1107 |
| 4 | \$783 | 11 | \$1161 |
| 5 | \$837 | 12 | \$1215 |
| 6 | \$891 | L | \$735 |
| 7 | \$945 | | |

NOTES: When selecting leather, the 2090 Series uses SR Leather only. All models are also available in Grade 1 EB vinyl (which matches SR Leather).

H2095



OPEN MARKET

EXECUTIVE HIGH-BACK

Pneumatic
Swivel
Tilt
Tilt Tension
Tilt Lock
Padded Loop Arms
Functions: **A, E, F, K, L**
(Function Key on pages 18-19)

DIMENSIONS

| | | | |
|--------------|-----|-----------------------|----------|
| Depth: | 29½ | Arm Width: | 21 |
| Width: | 26¾ | Seat to Floor Height: | 16-21 |
| Height: | 47½ | Usable Seat Depth: | 17½ |
| Seat Depth: | 17½ | Ship Weight: | 57 |
| Seat Width: | 21 | Cube: | 7.1 |
| Back Width: | 21 | COM: | N/A |
| Back Height: | 29½ | Weight Rating: | 275 lbs. |

FABRIC PRICE CODES

Fabric
PWST10 **\$437** (Black)
PWST90 **\$437** (Navy)
SofThread™ Leather
PWST11 **\$457** (Black)

NOTES: When selecting upholstery, the H2095 is only available in PWST10 (Black fabric), PWST90 (Navy fabric), and PWST11 (Black SofThread™ Leather).

H2092



MANAGERIAL MID-BACK

Pneumatic
Swivel
Tilt
Tilt Tension
Tilt Lock
Arms
Functions: **A, E, F, K, L**
(Function Key on pages 18-19)

DIMENSIONS

| | | | |
|--------------|-----|-----------------------|----------|
| Depth: | 28¾ | Arm Width: | 20¼ |
| Width: | 26¼ | Seat to Floor Height: | 16¾-21¼ |
| Height: | 41¾ | Usable Seat Depth: | 18½ |
| Seat Depth: | 21 | Ship Weight: | 54 |
| Seat Width: | 22 | Cube: | 16.0 |
| Back Width: | 22 | COM: | 3.0 |
| Back Height: | 19¾ | Weight Rating: | 300 lbs. |

FABRIC PRICE CODES

| | | | |
|----------|--------------|-----------|---------------|
| 1 | \$559 | 8 | \$793 |
| 2 | \$631 | 9 | \$1027 |
| 3 | \$703 | 10 | \$1081 |
| 4 | \$757 | 11 | \$1135 |
| 5 | \$811 | 12 | \$1189 |
| 6 | \$865 | L | \$709 |
| 7 | \$919 | | |

NOTES: When selecting leather, the 2090 Series uses SR Leather only. All models are also available in Grade 1 EB vinyl (which matches SR Leather).

H2093



GUEST CHAIR

Sled Base
Arms

DIMENSIONS

| | | | |
|--------------|-----|-----------------------|----------|
| Depth: | 27¾ | Arm Width: | 19¾ |
| Width: | 23¼ | Seat to Floor Height: | 19½ |
| Height: | 36 | Usable Seat Depth: | 19 |
| Seat Depth: | 21½ | Ship Weight: | 38 |
| Seat Width: | 20¾ | Cube: | 16.1 |
| Back Width: | 21½ | COM: | 2.5 |
| Back Height: | 19¼ | Weight Rating: | 300 lbs. |

FABRIC PRICE CODES

| | | | |
|----------|--------------|-----------|--------------|
| 1 | \$447 | 8 | \$792 |
| 2 | \$507 | 9 | \$837 |
| 3 | \$567 | 10 | \$882 |
| 4 | \$612 | 11 | \$927 |
| 5 | \$657 | 12 | \$972 |
| 6 | \$702 | L | \$597 |
| 7 | \$747 | | |

NOTES: When selecting leather, the 2090 Series uses SR Leather only. All models are also available in Grade 1 EB vinyl (which matches SR Leather).

HOW TO SPECIFY

HON Recommendation: H2091.H.SR11.T - List Price \$735

| | | | |
|--|---|--|---|
| <p>Select Model Number</p> <p>H 2 0 9 1 .</p> | <p>Select Caster</p> <p>H Hard Caster S Soft Caster (+ \$30) <i>Does not apply to models H2093 or H2095</i></p> <p>H .</p> | <p>Select Fabric</p> <p>See page 227 <i>H2095 only available in 3 fabric options. See above for pricing and selection.</i></p> <p>S R 1 1 .</p> | <p>Select Frame</p> <p>T Black</p> <p>T</p> |
|--|---|--|---|

PILLOW-SOFT® 2190 SERIES



Pillow-Soft Executive High-Back and Guest Chairs shown with Park Avenue Collection® Laminate desks.

PILLOW-SOFT® 2190 SERIES

Pillow-Soft chairs combine comfort, style and selection to deliver the ultimate seating experience. Each executive chair in the collection combines thick memory foam cushioning with built-in lumbar support to reduce fatigue and increase comfort. Besides the full body support, it adds an authoritative presence to the office. The plush tufted leather or fabric and optional hardwood accents will add a touch of sophistication to your office.



FEATURES

- Responsive memory foam eliminates pressure points and provides lasting comfort.
- Loop arms relieve stress on the shoulder and neck.
- Fully-upholstered outer back.
- Base features a steel substrate with hardwood base caps.
- Memory foam seat cushion reduces pressure points and responds to contours of the body for lasting comfort.
- Dual-wheel, hooded casters roll effortlessly and silently.
- Solid hardwood in one of eight attractive finishes.
- Warranted for users up to 250 lbs.

PILLOW-SOFT® 2190 Series Options

MODEL OPTIONS

H2191



Executive High-Back

Pneumatic, Swivel, Tilt, Tilt Tension, Tilt Lock, Open Padded Loop Arms

H2192



Managerial Mid-Back

Pneumatic, Swivel, Tilt, Tilt Tension, Tilt Lock, Open Padded Loop Arms

H2194



Guest Chair

4-Leg Base, Open Loop Arms

AVAILABLE FINISHES

Pillow-Soft® 2190 Series Seating is available in 8 wood finishes.

WOOD FINISHES

Bourbon Cherry (H)

Cognac (COGN)

Harvest (C)

Mahogany (N)

Mocha (MOCH)

Natural Maple (D)

Pinnacle (PINC)

Shaker Cherry (F)

HON BRANDED FABRICS

GRADE 1

Black Vinyl
Burgundy Vinyl
Centurion
Compass
Contourette Polyurethane
Dapper
Hamilton
Inertia
Optic

GRADE 2

Appoint Seating
Clyde
Dotty
Rush
Seed
Spin Seating
Whisper Vinyl

GRADE 3

Purl
Silvertex™ Vinyl

For a complete list of fabrics, including partnership fabrics, go to hon.com/fabricsandfinishes.

Reference Fabric Color Combinations on pages 20-24 for color codes and legend on page 21 for lead times. For additional HON to Supply COM fabric grade pricing, go to honready.hon.com and click on the HON to Supply COM link.

 For Fire Code model, availability and ordering method, refer to pages 28-31. Available on select models, contact HON Customer Support for availability.



Icon Legend on page 17

PILLOW-SOFT® 2190 Series

H2191



EXECUTIVE HIGH-BACK

Pneumatic
Swivel
Tilt
Tilt Tension
Tilt Lock
Open Padded Loop Arms
Functions: **A, E, F, K, L**
(Function Key on pages 18-19)

DIMENSIONS

| | | | |
|--------------|-----|-----------------------|----------|
| Depth: | 29¾ | Arm Width: | 22¼ |
| Width: | 26¼ | Seat to Floor Height: | 16¾-21¼ |
| Height: | 46½ | Usable Seat Depth: | 18½ |
| Seat Depth: | 21 | Ship Weight: | 60 |
| Seat Width: | 22 | Cube: | 16.0 |
| Back Width: | 22 | COM: | 3.0 |
| Back Height: | 25 | Weight Rating: | 250 lbs. |

FABRIC PRICE CODES

| | | | |
|----------|---------------|-----------|---------------|
| 1 | \$920 | 8 | \$1334 |
| 2 | \$992 | 9 | \$1388 |
| 3 | \$1064 | 10 | \$1442 |
| 4 | \$1118 | 11 | \$1496 |
| 5 | \$1172 | 12 | \$1550 |
| 6 | \$1226 | L | \$1070 |
| 7 | \$1280 | | |

NOTES: Arms are laminated hardwood with urethane top pads. Also available in Grade 1 vinyl EB11 and EB69. (EB matching vinyl used with SR Leather).

H2192



MANAGERIAL MID-BACK

Pneumatic
Swivel
Tilt
Tilt Tension
Tilt Lock
Open Padded Loop Arms
Functions: **A, E, F, K, L**
(Function Key on pages 18-19)

DIMENSIONS

| | | | |
|--------------|-----|-----------------------|----------|
| Depth: | 28¾ | Arm Width: | 22¼ |
| Width: | 26¼ | Seat to Floor Height: | 16¾-21¼ |
| Height: | 41¾ | Usable Seat Depth: | 18½ |
| Seat Depth: | 21 | Ship Weight: | 57 |
| Seat Width: | 22 | Cube: | 16.0 |
| Back Width: | 22 | COM: | 2.5 |
| Back Height: | 19½ | Weight Rating: | 250 lbs. |

FABRIC PRICE CODES

| | | | |
|----------|---------------|-----------|---------------|
| 1 | \$893 | 8 | \$1238 |
| 2 | \$953 | 9 | \$1283 |
| 3 | \$1013 | 10 | \$1328 |
| 4 | \$1058 | 11 | \$1373 |
| 5 | \$1103 | 12 | \$1418 |
| 6 | \$1148 | L | \$1043 |
| 7 | \$1193 | | |

NOTES: Arms are laminated hardwood with urethane top pads. Also available in Grade 1 vinyl EB11 and EB69. (EB matching vinyl used with SR Leather).

H2194



GUEST CHAIR

4-Leg Base
Open Loop Arms

DIMENSIONS

| | | | |
|--------------|-----|-----------------------|----------|
| Depth: | 27½ | Arm Width: | 19¾ |
| Width: | 23¼ | Seat to Floor Height: | 19½ |
| Height: | 35½ | Usable Seat Depth: | 19 |
| Seat Depth: | 21½ | Ship Weight: | 49 |
| Seat Width: | 20¾ | Cube: | 17.3 |
| Back Width: | 21½ | COM: | 2.5 |
| Back Height: | 19¼ | Weight Rating: | 250 lbs. |

FABRIC PRICE CODES

| | | | |
|----------|--------------|-----------|---------------|
| 1 | \$694 | 8 | \$1039 |
| 2 | \$754 | 9 | \$1084 |
| 3 | \$814 | 10 | \$1129 |
| 4 | \$859 | 11 | \$1174 |
| 5 | \$904 | 12 | \$1219 |
| 6 | \$949 | L | \$844 |
| 7 | \$994 | | |

NOTES: Guest Chairs available in 4-Leg Base. Also available in Grade 1 vinyl EB11 and EB69. (EB matching vinyl used with SR Leather).

HON Recommendation: H2191.MOCH.CU__ - List Price \$920

HOW TO SPECIFY

| | | |
|--|--|--|
| <p>Select Model Number</p> <p>H 2 1 9 1</p> | <p>Select Finish</p> <p>See page 230</p> <p>M O C H</p> | <p>Select Fabric</p> <p>See page 230</p> <p>C U 1 0</p> |
|--|--|--|

PROMINENT™ Mesh Chairs

OPEN MARKET



Icon Legend on page 17

HVL531



HIGH-BACK

Pneumatic
Swivel
Tilt
Tilt Tension
Tilt Lock
Height-adjustable Arms
Functions: **A, E, F, K, L, Q**
(Function Key on pages 18-19)

DIMENSIONS

| | | | |
|--------------|-----|-----------------------|----------|
| Depth: | 36 | Arm Width: | 20¼ |
| Width: | 29 | Seat to Floor Height: | 18-22 |
| Height: | 42½ | Usable Seat Depth: | 18 |
| Seat Depth: | 18 | Ship Weight: | 36 Ⓢ |
| Seat Width: | 21½ | Cube: | 5.1 |
| Back Width: | 18¾ | Weight Rating: | 250 lbs. |
| Back Height: | 23 | | |

PRICE CODE

| | |
|----------------------|--------------|
| Sandwich Mesh | \$313 |
| Leather | \$338 |

NOTES: Comfortable and breathable mesh back. Black sandwich mesh or Black SofThread™ Leather seat. Black frame. Height-adjustable arms. **HON 5-Year Limited Warranty.**

HON Recommendation: HVL531.MM10 - List Price \$313

HVL530



HIGH-BACK

Synchro-tilt with Seat Slide
Back Height Adjustment
Height and Width Adjustable Arms
Functions: **A, B, D, E, J, S**
(Function Key on pages 18-19)

DIMENSIONS

| | | | |
|-------------|-----|-----------------------|----------|
| Depth: | 26¾ | Back Height: | 22¼ |
| Width: | 26 | Arm Width: | 18¾ |
| Height: | 44¼ | Seat to Floor Height: | 17¼-21 |
| Seat Depth: | 17½ | Ship Weight: | 46 |
| Seat Width: | 20¾ | Cube: | 5.0 |
| Back Width: | 17⅞ | Weight Rating: | 250 lbs. |

PRICE CODE

| | |
|----------------------|--------------|
| Sandwich Mesh | \$339 |
|----------------------|--------------|

NOTES: **HON 5-Year Limited Warranty.**

HON Recommendation: HVL530.MM10 - List Price \$339

HVL532



HIGH-BACK

Mesh Back
Pneumatic
Swivel
Asynchronous Control
Tilt
Tilt Tension
Tilt Lock
Seat Glide Mechanism
Back Height Adjustment
Height and Width Adjustable Arms
Functions: **A, B, D, E, F, L, O, S**
(Function Key on pages 18-19)

DIMENSIONS

| | | | |
|-------------|---------|-----------------------|----------|
| Depth: | 26 | Back Height: | 23¼-24½ |
| Width: | 30¾ | Arm Width: | 18-22⅝ |
| Height: | 44½ | Seat to Floor Height: | 17-20½ |
| Seat Depth: | 17⅞-20⅞ | Ship Weight: | 50 Ⓢ |
| Seat Width: | 20½ | Cube: | 6.5 |
| Back Width: | 19⅞ | Weight Rating: | 250 lbs. |

PRICE CODE

| | |
|----------------------|--------------|
| Sandwich Mesh | \$372 |
| Leather | \$397 |

NOTES: Comfortable and breathable mesh back. Black sandwich mesh or Black SofThread™ Leather seat. Black frame. Height and width adjustable arms. Seat glide mechanism. Asynchronous control with independent seat and back angle adjustment. **HON 5-Year Limited Warranty.**

HON Recommendation: HVL532.MM10 - List Price \$372

HOW TO SPECIFY

| | |
|----------------------------|---|
| <p>Select Model Number</p> | <p>Select Fabric</p> <p>MM10 Black Sandwich Mesh Fabric <i>HVL530 available in MM10 only</i></p> <p>SB11 Black SofThread™ Leather</p> |
| <p>H V L 5 3 1 .</p> | <p>M M 1 0</p> |



PROMINENT™ Mesh Chairs

HVL534



HIGH-BACK

Pneumatic
Swivel
Tilt
Tilt Tension
Tilt Lock
Height-adjustable Arms

Functions: **A, E, F, K, L, Q**
(Function Key on pages 18-19)

DIMENSIONS

| | | | |
|--------------|--------------------------------|-----------------------|--|
| Depth: | 27 | Arm Width: | 19 ⁵ / ₈ |
| Width: | 27 | Seat to Floor Height: | 17 ¹ / ₈ -20 ³ / ₄ |
| Height: | 41 ¹ / ₈ | Usable Seat Depth: | 19 ¹ / ₈ |
| Seat Depth: | 19 ¹ / ₈ | Ship Weight: | 40.6 Ⓢ |
| Seat Width: | 20 ¹ / ₈ | Cube: | 5.7 |
| Back Width: | 19 ¹ / ₈ | Weight Rating: | 250 lbs. |
| Back Height: | 22 ³ / ₈ | | |

PRICE CODE

Mesh \$384

NOTES: Prominent™ HVL534. Comfortable and breathable mesh back. Black mesh seat. Height-adjustable arms. **HON 5-Year Limited Warranty.**

HON Recommendation: HVL534.MST3 - List Price \$384

HVL539



TASK STOOL

Mesh Back
Pneumatic
Swivel
Height and Width Adjustable Arms
Adjustable Footring

Functions: **A, E, S**
(Function Key on pages 18-19)

DIMENSIONS

| | | | |
|--------------|----------------------------------|-----------------------|--|
| Depth: | 27 ⁹ / ₁₆ | Arm Width: | 18 ¹ / ₈ |
| Width: | 28 ⁷ / ₃₂ | Seat to Floor Height: | 21 ⁹ / ₃₂ -28 ⁵ / ₃₂ |
| Height: | 50 | Usable Seat Depth: | 17 ¹ / ₈ |
| Seat Depth: | 17 ¹ / ₈ | Ship Weight: | 44.0 Ⓢ |
| Seat Width: | 20 ¹⁵ / ₃₂ | Cube: | 5.7 |
| Back Width: | 17 ¹ / ₈ | Weight Rating: | 250 lbs. |
| Back Height: | 22 ²⁷ / ₃₂ | | |

PRICE CODE

Mesh \$319

NOTES: Prominent™ HVL539. Black upholstered seat. Height and width adjustable arms. **HON 5-Year Limited Warranty.**

HON Recommendation: HVL539.MM10 - List Price \$319

HVL537



HIGH-BACK

Mesh Back
Synchro-tilt with Seat Slide
Back Height Adjustment
Height and Width Adjustable Arms
Mesh Seat

Functions: **A, B, D, E, J, S**
(Function Key on pages 18-19)

DIMENSIONS

| | | | |
|--------------|--------------------------------|-----------------------|------------------------------------|
| Depth: | 26 ¹ / ₂ | Arm Width: | 18 ³ / ₄ |
| Width: | 26 ¹ / ₂ | Seat to Floor Height: | 17 ³ / ₄ -21 |
| Height: | 44 ³ / ₄ | Usable Seat Depth: | 17 ³ / ₄ |
| Seat Depth: | 17 ³ / ₄ | Ship Weight: | 46.0 |
| Seat Width: | 20 ³ / ₄ | Cube: | 5.0 |
| Back Width: | 17 ¹ / ₈ | Weight Rating: | 250 lbs. |
| Back Height: | 22 ¹ / ₄ | | |

PRICE CODE

Mesh \$410

NOTES: **HON 5-Year Limited Warranty.**

HON Recommendation: HVL537.MST3 - List Price \$410

HVL536



HIGH-BACK

Mesh Back
Asynchronous with Seat Slide
Back Height Adjustment
Height and Width Adjustable Arms
Mesh Seat

Functions: **A, B, D, E, F, L, O, S**
(Function Key on pages 18-19)

DIMENSIONS

| | | | |
|--------------|--------------------------------|-----------------------|--|
| Depth: | 26 ¹ / ₂ | Arm Width: | 18 ⁷ / ₈ |
| Width: | 26 ¹ / ₂ | Seat to Floor Height: | 16 ¹ / ₈ -20 ³ / ₈ |
| Height: | 44 ³ / ₄ | Usable Seat Depth: | 17 ¹ / ₈ |
| Seat Depth: | 17 ³ / ₄ | Ship Weight: | 48.7 |
| Seat Width: | 20 ¹ / ₂ | Cube: | 6.3 |
| Back Width: | 17 ¹ / ₈ | Weight Rating: | 250 lbs. |
| Back Height: | 22 ³ / ₈ | | |

PRICE CODE

Mesh \$435

NOTES: **HON 5-Year Limited Warranty.**

HON Recommendation: HVL536.MST3 - List Price \$435

HOW TO SPECIFY

Select Model Number

Select Fabric

- MM10** Black Sandwich Mesh Fabric
Specify for model HVL539 only
- MST3** Black Mesh
Specify for models HVL534, HVL536 and HVL537 only

H V L 5 3 4 .

M S T 3

PURPOSE®



Purpose Task Chairs shown with Voi® Desks.

PURPOSE®

Purpose is designed to flex and adjust to you. Your posture. Your weight. Your movements. Whether in a task chair or stool, the seat and back move independently to constantly respond changes in weight distribution and motion. The innovative YouFit® technology provides a tailored fit with three distinct flex zones to support a range of postures, including sitting, reclining or perching. Designed to intuitively respond to each user's body, there are no complex manual adjustments to master. With Purpose, sitting is believing.



FEATURES

- YouFit® technology intuitively responds to your body's movements.
- The seat and back to move independently for a more comfortable recline.
- Optional arms increase upper body support.
- One-touch seat height adjustment easily moves the seat up and down.
- Shell is available in either Onyx or Platinum.
- Warranted for users up to 300 lbs.

MODEL OPTIONS

HR1P



Task Chair (YouFit[®] Technology)

Plastic Seat and Back, Pneumatic, Swivel

HR1S



Task Chair (YouFit[®] Technology)

Upholstered Seat, Plastic Back, Pneumatic, Swivel

HR1W



Task Chair (YouFit[®] Technology)

Upholstered Seat and Back, Pneumatic, Swivel

HR5P



Task Stool (YouFit[®] Technology)

Plastic Seat and Back, Pneumatic, Swivel, Adjustable Footring

HR5S



Task Stool (YouFit[®] Technology)

Upholstered Seat, Plastic Back, Pneumatic, Swivel, Adjustable Footring

HR5W



Task Stool (YouFit[®] Technology)

Upholstered Seat and Back, Pneumatic, Swivel, Adjustable Footring

ARM STYLE

| CODE | DESCRIPTION | PRICE |
|-------------|--------------------------|--------------|
| N | Armless | +\$0 |
| FBLK | Fixed Black Arms | +\$65 |
| FBLT | Fixed Platinum Arms | +\$65 |
| ABLK | Adjustable Black Arms | +\$75 |
| APLT | Adjustable Platinum Arms | +\$75 |



CASTERS

| CODE | DESCRIPTION | PRICE |
|----------|-------------|--------------|
| H | Hard Caster | +\$0 |
| S | Soft Caster | +\$30 |



SHELL COLOR

| CODE | DESCRIPTION | PRICE |
|-----------|-------------|-------------|
| ON | Onyx | +\$0 |
| PT | Platinum | +\$0 |

BASE

| CODE | DESCRIPTION | PRICE |
|-------------|-------------|-------------|
| T | Black | +\$0 |
| PLAT | Platinum | +\$0 |

PURPOSE[®] Fabric Options

HON BRANDED FABRICS

GRADE 1
Centurion

GRADE 2

GRADE 3
Silvertex™ Vinyl

For a complete list of fabrics, including partnership fabrics, go to hon.com/fabricsandfinishes.

Reference Fabric Color Combinations on pages 20-24 for color codes and legend on page 21 for lead times.

⚠ For Fire Code model, availability and ordering method, refer to pages 28-31. Available on select models, contact HON Customer Support for availability.

PURPOSE[®] Dimensions

DIMENSIONS

| MODEL | HRIP | HRIS | HR1W | HR5P | HR5S | HR5W |
|----------------------------------|-----------|-----------|-----------|-----------|---------|---------|
| Depth Armless | 26" | 26" | 26" | 26" | 26" | 26" |
| Depth with Fixed Arms | 26" | 26" | 26" | 26" | 26" | 26" |
| Depth with Adjustable Arms | 26" | 26" | 26" | 26" | 26" | 26" |
| Width Armless | 26" | 26" | 26" | 26" | 26" | 26" |
| Width with Fixed Arms | 26" | 26" | 26" | 26" | 26" | 26" |
| Width with Adjustable Arms | 27½" | 27½" | 27½" | 27½" | 27½" | 27½" |
| Height Armless | 37½" | 37½" | 37½" | 50¾" | 50¾" | 50¾" |
| Height with Fixed Arms | 37½" | 37½" | 37½" | 50¾" | 50¾" | 50¾" |
| Height with Adjustable Arms | 37½" | 37½" | 37½" | 50¾" | 50¾" | 50¾" |
| Seat Depth | 15¾" | 16½" | 16" | 15¾" | 16½" | 16" |
| Seat Width | 19" | 19½" | 19½" | 19" | 19½" | 19½" |
| Back Width | 18" | 18" | 18" | 18" | 18" | 18" |
| Back Height | 19¾" | 19¼" | 19¼" | 19¾" | 19¾" | 19¼" |
| Adjustable Arms Width | 20" | 20" | 20" | 20" | 20" | 20" |
| Fixed Arms Width | 21" | 21" | 21" | 21" | 21" | 21" |
| Seat to Floor Height | 16¼"-20¼" | 16½"-20½" | 16½"-20½" | 23¾"-33¾" | 24"-34" | 24"-34" |
| Usable Seat Depth | 15¾" | 16½" | 16" | 16½" | 16½" | 16" |
| Ship Weight Armless | 28 Ⓢ | 30 Ⓢ | 31 Ⓢ | 34 Ⓢ | 36 Ⓢ | 37 Ⓢ |
| Ship Weight with Fixed Arms | 32 Ⓢ | 34 Ⓢ | 35 Ⓢ | 38 Ⓢ | 39 Ⓢ | 41 Ⓢ |
| Ship Weight with Adjustable Arms | 33 Ⓢ | 35 Ⓢ | 36 Ⓢ | 39 Ⓢ | 40 Ⓢ | 41 Ⓢ |
| Cube Armless | 11.1 | 11.1 | 11.1 | 11.1 | 11.1 | 11.1 |
| Cube with Fixed Arms | 11.1 | 11.1 | 11.1 | 11.1 | 11.1 | 11.1 |
| Cube with Adjustable Arms | 11.1 | 11.1 | 11.1 | 11.1 | 11.1 | 11.1 |
| Weight Capacity | 300 lbs | 300 lbs | 300 lbs | 300 lbs | 300 lbs | 300 lbs |



Icon Legend on page 17

HR1P



TASK CHAIR

YouFit® Technology
 Plastic Seat and Back
 Pneumatic
 Swivel
 Functions: **A, Q, E**
 (Function Key on pages 18-19)

DIMENSIONS

| | | | |
|--------------|-----|-----------------------|-------------|
| Depth: | 26 | Seat to Floor Height: | 16¼-20¼ |
| Width: | 26 | Usable Seat Depth: | 15¾ |
| Height: | 37½ | Ship Weight: | 28 Ⓢ |
| Seat Depth: | 15¾ | Cube: | 11.1 |
| Seat Width: | 19 | Weight Rating: | 300 lbs. |
| Back Width: | 18 | | |
| Back Height: | 19¾ | | |

LIST PRICE

\$392

NOTES: Add **"FC"** suffix to Model Number for CA Technical Bulletin 133 compliance. Add upcharge of \$40. See page 239 for Fixed or Adjustable Arm packs.

! Dimensions, weights and cubes shown above are for the armless model only. See page 236 for all other arm type specifications.

HR1S



TASK CHAIR

YouFit® Technology
 Upholstered Seat
 Plastic Back
 Pneumatic
 Swivel
 Functions: **A, Q, E**
 (Function Key on pages 18-19)

DIMENSIONS

| | | | |
|--------------|-----|-----------------------|-------------|
| Depth: | 26 | Seat to Floor Height: | 16½-20½ |
| Width: | 26 | Usable Seat Depth: | 16½ |
| Height: | 37½ | Ship Weight: | 30 Ⓢ |
| Seat Depth: | 16½ | Cube: | 11.1 |
| Seat Width: | 19½ | Weight Rating: | 300 lbs. |
| Back Width: | 18 | | |
| Back Height: | 19¼ | | |

FABRIC PRICE CODES

1 \$476
3 \$524

NOTES: Add **"FC"** suffix to Model Number for CA Technical Bulletin 133 compliance. Add upcharge of \$90. See page 239 for Fixed or Adjustable Arm packs.

! Dimensions, weights and cubes shown above are for the armless model only. See page 236 for all other arm type specifications.

HR1W

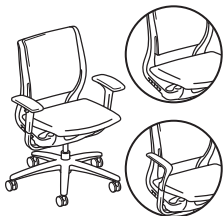

TASK CHAIR

YouFit® Technology
 Upholstered Seat and Back
 Pneumatic
 Swivel
 Functions: **A, Q, E**
 (Function Key on pages 18-19)

DIMENSIONS

| | | | |
|--------------|-----|-----------------------|-------------|
| Depth: | 26 | Seat to Floor Height: | 16½-20½ |
| Width: | 26 | Usable Seat Depth: | 16 |
| Height: | 37½ | Ship Weight: | 31 Ⓢ |
| Seat Depth: | 16 | Cube: | 11.1 |
| Seat Width: | 19½ | Weight Rating: | 300 lbs. |
| Back Width: | 18 | | |
| Back Height: | 19¼ | | |

FABRIC PRICE CODES

1 \$532
3 \$580

NOTES: Add **"FC"** suffix to Model Number for CA Technical Bulletin 133 compliance. Add upcharge of \$90. See page 239 for Fixed or Adjustable Arm packs.

! Dimensions, weights and cubes shown above are for the armless model only. See page 236 for all other arm type specifications.

HON Recommendation: HR1W.APLT.H.PT.CU___.PLAT - List Price \$607

HOW TO SPECIFY

| Select Model Number | Select Arm Type | Select Caster/Glide | Select Shell Color | Select Fabric | Select Base |
|--|---|--------------------------------------|--|--|-------------|
| ABLK Adjustable Black Arms (+ \$75) APLT Adjustable Platinum Arms (+ \$75) FBLK Fixed Black Arms (+ \$65) FPLT Fixed Platinum Arms (+ \$65) N Armless | H Hard Caster S Soft Caster (+ \$30) | ON Onyx PT Platinum | CU Centurion (Grade 1) SX Silvertex™ (Grade 3) <i>Not specified for model HR1P</i> See pages 22 and 24 for Centurion and Silvertex™ color options | T Black PLAT Platinum | |
| HR1W . | APLT . | H . | PT . | CU10 . | PLAT |
| HR1WFC . | APLT . | H . | PT . | CU10 . | PLAT |

! Fire Code Option: For CA Technical Bulletin 133 compliant shells and fabric. Available shell colors are ON Onyx and PT Platinum; Fabric available in CU Centurion only. **Add Suffix: FC** to model number as shown above. **Note \$40 upcharge per plastic seat and \$90 upcharge per upholstered seat.**

PURPOSE®



Icon Legend on page 17

HR5P



TASK STOOL

YouFit® Technology
Plastic Seat and Back
Pneumatic
Swivel
Adjustable Footring

Functions: **A, Q, E**
(Function Key on pages 18-19)

DIMENSIONS

| | | | |
|--------------|-----|-----------------------|----------|
| Depth: | 26 | Seat to Floor Height: | 23¾-33¾ |
| Width: | 26 | Usable Seat Depth: | 16½ |
| Height: | 50¾ | Ship Weight: | 34 Ⓢ |
| Seat Depth: | 15¾ | Cube: | 11.1 |
| Seat Width: | 19 | Weight Rating: | 300 lbs. |
| Back Width: | 18 | | |
| Back Height: | 19¾ | | |

LIST PRICE

\$444

NOTES: Add "**FC**" suffix to Model Number for CA Technical Bulletin 133 compliance. Add upcharge of \$40. See page 239 for Fixed or Adjustable Arm packs.

ⓘ Dimensions, weights and cubes shown above are for the armless model only. See page 236 for all other arm type specifications.

HR5S



TASK STOOL

YouFit® Technology
Upholstered Seat
Plastic Back
Pneumatic
Swivel
Adjustable Footring

Functions: **A, Q, E**
(Function Key on pages 18-19)

DIMENSIONS

| | | | |
|--------------|-----|-----------------------|----------|
| Depth: | 26 | Seat to Floor Height: | 24-34 |
| Width: | 26 | Usable Seat Depth: | 16½ |
| Height: | 50¾ | Ship Weight: | 36 Ⓢ |
| Seat Depth: | 16½ | Cube: | 11.1 |
| Seat Width: | 19½ | Weight Rating: | 300 lbs. |
| Back Width: | 18 | | |
| Back Height: | 19¾ | | |

FABRIC PRICE CODES

1 \$529
3 \$577

NOTES: Add "**FC**" suffix to Model Number for CA Technical Bulletin 133 compliance. Add upcharge of \$90. See page 239 for Fixed or Adjustable Arm packs.

ⓘ Dimensions, weights and cubes shown above are for the armless model only. See page 236 for all other arm type specifications.

HR5W



TASK STOOL

YouFit® Technology
Upholstered Seat and Back
Pneumatic
Swivel
Adjustable Footring

Functions: **A, Q, E**
(Function Key on pages 18-19)

DIMENSIONS

| | | | |
|--------------|-----|-----------------------|----------|
| Depth: | 26 | Seat to Floor Height: | 24-34 |
| Width: | 26 | Usable Seat Depth: | 16 |
| Height: | 50¾ | Ship Weight: | 37 Ⓢ |
| Seat Depth: | 16 | Cube: | 11.1 |
| Seat Width: | 19½ | Weight Rating: | 300 lbs. |
| Back Width: | 18 | | |
| Back Height: | 19¼ | | |

FABRIC PRICE CODES

1 \$584
3 \$632

NOTES: Add "**FC**" suffix to Model Number for CA Technical Bulletin 133 compliance. Add upcharge of \$90. See page 239 for Fixed or Adjustable Arm packs.

ⓘ Dimensions, weights and cubes shown above are for the armless model only. See page 236 for all other arm type specifications.

HOW TO SPECIFY

| Select Model Number | Select Arm Type | Select Caster/Glide | Select Shell Color | Select Fabric | Select Base |
|---------------------|--|---|--------------------------------------|--|--|
| HR5P | ABLK Adjustable Black Arms (+ \$75) APLT Adjustable Platinum Arms (+ \$75) FBLK Fixed Black Arms (+ \$65) FPLT Fixed Platinum Arms (+ \$65) N Armless | H Hard Caster S Soft Caster (+ \$30) | ON Onyx PT Platinum | CU Centurion (Grade 1) SX Silvertex™ (Grade 3) <i>Not specified for model HR5P</i> See pages 22 and 24 for Centurion and Silvertex™ color options | T Black PLAT Platinum |
| HR5PFC | APLT | H | PT | CU10 | PLAT |

⚠ Fire Code Option: For CA Technical Bulletin 133 compliant shells and fabric. Available shell colors are ON Onyx and PT Platinum; Fabric available in CU Centurion only. **Add Suffix: FC** to model number as shown above. **Note \$40 upcharge per plastic seat and \$90 upcharge per upholstered seat.**



HRAAP

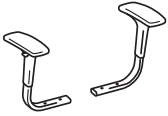

ADJUSTABLE ARM PACK

Available in Black (T) or Platinum (PLAT)

DIMENSIONS

Adjustable Arms Width: 20
 Height from Seat: 6¾-10¾
 Ship Weight: 5 **S**
 Cube: 1.0

LIST PRICE

\$112

HRFAP

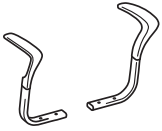

FIXED ARM PACK

Available in Black (T) or Platinum (PLAT)

DIMENSIONS

Arm Width: 21
 Height from Seat: 9
 Ship Weight: 5 **S**
 Cube: 1.0

LIST PRICE

\$102

HOW TO SPECIFY

| | |
|-----------------------------------|--|
| <p>Select Model Number</p> | <p>Select Arm Color</p> <p>T Black PLAT Platinum</p> |
| <p>HRAAP.</p> | <p>T</p> |

QUOTIENT®



Quotient Task Chairs shown with Voi® Desks.

QUOTIENT®

Finding a universal seating solution to satisfy a variety of needs and users can be challenging, especially with something as personal as a chair. With a mesh back for comfort, an advanced seat cushion that follows the body's contours, and a stool option for standing-height worksurfaces, Quotient is much more than the sum of its parts. Height- and width-adjustable arms help anyone find the upper body support they need. The perfect blend of comfort and style, Quotient is where form and function are perfectly divided.



FEATURES

- Contoured seat cushion reduces pressure points.
- Responsive synchro-tilt control provides a smooth, natural recline.
- ilira®-stretch material cradles the spine.
- One-touch seat height adjustment easily moves the seat up and down.
- Tilt tension controls the rate and ease of recline.
- Tilt lock allows the user to lock out the tilt function.
- 360-degree swivel provides freedom of movement in any direction.
- Height- and width-adjustable arms provide a custom fit.
- Available in hundreds of quality HON fabrics.
- Warranted for users up to 300 lbs.

MODEL OPTIONS

HQTMM



Task Chair

Pneumatic, Swivel, Synchro-tilt, Tilt Tension, Tilt Lock

HQTSM



Task Stool

Pneumatic, Swivel, Synchro-tilt, Tilt Tension, Tilt Lock

MECHANISM

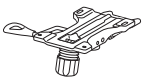

| CODE | DESCRIPTION | PRICE |
|-----------|--------------|-------------|
| YO | Synchro-Tilt | +\$0 |

ARM STYLE



| CODE | DESCRIPTION | PRICE |
|----------|----------------------------------|--------------|
| N | Armless | +\$0 |
| A | Height and Width Adjustable Arms | +\$75 |

CASTERS/ GLIDE



| CODE | DESCRIPTION | PRICE |
|----------|-------------|-------------|
| H | Hard Caster | +\$0 |



| | | |
|----------|-------------|--------------|
| S | Soft Caster | +\$30 |
|----------|-------------|--------------|



| | | |
|----------|------------|--------------|
| G | Bell Glide | +\$25 |
|----------|------------|--------------|

BACK



| CODE | DESCRIPTION | PRICE |
|--|-------------|-------------|
| <i>ilira®-stretch mesh back options:</i> | | |
| IM | Black | +\$0 |

BASE



| CODE | DESCRIPTION | PRICE |
|-----------|---------------|-------------|
| SB | Standard Base | +\$0 |

QUOTIENT® Fabric Options

HON BRANDED FABRICS

GRADE 1

Attire
Centurion
Compass
Contourette Polyurethane
Dapper
Hamilton
Inertia
Optic

GRADE 2

Appoint Seating
Clyde
Dotty
Rush
Seed
Spin Seating
Whisper Vinyl

GRADE 3

In Season
Purl
Silvertex™ Vinyl

GRADE L

Denver Leather

For a complete list of fabrics, including partnership fabrics, go to hon.com/fabricsandfinishes.

Reference Fabric Color Combinations on pages 20-24 for color codes and legend on page 21 for lead times.

 For Fire Code model, availability and ordering method, refer to pages 28-31. Available on select models, contact HON Customer Support for availability.



HQTMM

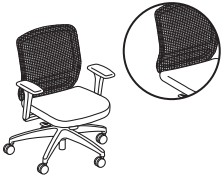

TASK CHAIR

Pneumatic
Swivel
Synchro-tilt
Tilt Tension
Tilt Lock
Functions: **A, E, J, K, L**
(Function Key on pages 18-19)

DIMENSIONS

| | | | |
|--------------|-----|--------------------------|---------------|
| Depth: | 29½ | Arm Width: | 17½-20 |
| Width: | 29½ | Seat to Floor Height: | 16-22 |
| Height: | 38½ | Usable Seat Depth: | 17 |
| Seat Depth: | 19¼ | Ship Weight (with arms): | 36.5 Ⓢ |
| Seat Width: | 19 | Ship Weight (armless): | 33.0 Ⓢ |
| Back Width: | 18 | Cube (with arms): | 7.6 |
| Back Height: | 19 | Cube (armless): | 7.6 |
| | | Weight Rating: | 300 lbs. |

FABRIC PRICE CODES

| | | | |
|----------|--------------|-----------|--------------|
| 1 | \$416 | 8 | \$485 |
| 2 | \$428 | 9 | \$494 |
| 3 | \$440 | 10 | \$503 |
| 4 | \$449 | 11 | \$512 |
| 5 | \$458 | 12 | \$521 |
| 6 | \$467 | L | \$516 |
| 7 | \$476 | | |

HQTSM



TASK STOOL

Pneumatic
Swivel
Synchro-tilt
Tilt Tension
Tilt Lock
Functions: **A, E, J, K, L**
(Function Key on pages 18-19)

DIMENSIONS

| | | | |
|--------------|-----|--------------------------|---------------|
| Depth: | 29½ | Arm Width: | 17½-20 |
| Width: | 29½ | Seat to Floor Height: | 23-33 |
| Height: | 49¼ | Usable Seat Depth: | 17 |
| Seat Depth: | 19¼ | Ship Weight (with arms): | 42.0 Ⓢ |
| Seat Width: | 19 | Ship Weight (armless): | 38.5 Ⓢ |
| Back Width: | 18 | Cube (with arms): | 7.6 |
| Back Height: | 19 | Cube (armless): | 7.6 |
| | | Weight Rating: | 300 lbs. |

FABRIC PRICE CODES

| | | | |
|----------|--------------|-----------|--------------|
| 1 | \$469 | 8 | \$538 |
| 2 | \$481 | 9 | \$547 |
| 3 | \$493 | 10 | \$556 |
| 4 | \$502 | 11 | \$565 |
| 5 | \$511 | 12 | \$574 |
| 6 | \$520 | L | \$569 |
| 7 | \$529 | | |

HON Recommendation: HQTMM.YO.A.H.IM.CU__SB - List Price \$491

HOW TO SPECIFY

| | | | | | | |
|--|--|--|---|---|---|---|
| <p>Select Model Number</p> <p>HQTMM</p> | <p>Select Control Type</p> <p>YO Synchro-Tilt</p> | <p>Select Arm Type</p> <p>N Armless A Height and Width Adjustable Arms (+ \$75)</p> | <p>Select Caster/Glide</p> <p>H Hard Caster S Soft Caster (+ \$30) G Bell Glide (+ \$25)</p> | <p>Select Mesh Back</p> <p>ilira®-stretch options IM Black</p> | <p>Select Fabric</p> <p>See page 242</p> | <p>Select Base</p> <p>SB Standard Base</p> |
| <p>H Q T M M .</p> | <p>Y O .</p> | <p>A .</p> | <p>H .</p> | <p>I M .</p> | <p>C U I O .</p> | <p>S B</p> |



Riley Ganging Chairs and Tables.

RILEY™

Create a welcoming area that perfectly fits your space and supports your guests with Riley. The linear, streamlined design of this guest chair collection puts you in control over your environment. Chairs can be ganged to create straight rows. Wrap around corner units. Even stand alone. Riley even feels at home in the corner office, with elegant lines, high-quality fabrics and rich hardwood finishes. Riley is a chameleon that is truly a welcome addition to any space.



FEATURES

- Nylon glides slide effortlessly on all surfaces.
- Graceful double-arched arms add style and comfort.
- Chairs can be connected in-line with a table between them, or arranged in an L-configuration by connecting to a corner table (bariatric chair cannot be ganged).
- Catalyzed finish enhances stain and mar resistance.
- HWGN1 is a stand-alone guest chair that can be used with tables on either side.
- Start with model HWGN2 for an in-line ganging layout, add HWGN3 for middle seats and HWGN4 to complete the grouping.
- Solid hardwood in one of eight attractive finishes.
- Available in hundreds of quality HON fabrics.
- Warranted for users up to 250 lbs. (Bariatric chair warranted for users up to 500 lbs.)

AVAILABLE FINISHES

Riley™ Series Seating is available in 8 wood finishes.

WOOD FINISHES

Bourbon Cherry (H)

Cognac (COGN)

Harvest (C)

Mahogany (N)

Mocha (MOCH)

Natural Maple (D)

Pinnacle (PINC)

Shaker Cherry (F)

HON BRANDED FABRICS

GRADE 1

Attire
Centurion
Compass
Contourette Polyurethane
Dapper
Hamilton
Inertia
Optic

GRADE 2

Appoint Seating
Clyde
Dotty
Rush
Seed
Spin Seating
Whisper Vinyl

GRADE 3

In Season
Purl
Silvertext™ Vinyl

GRADE L

Denver Leather

For a complete list of fabrics, including partnership fabrics, go to hon.com/fabricsandfinishes.

Reference Fabric Color Combinations on pages 20-24 for color codes and legend on page 21 for lead times. For additional HON to Supply COM fabric grade pricing, go to honready.hon.com and click on the HON to Supply COM link.

 For Fire Code model, availability and ordering method, refer to pages 28-31. Available on select models, contact HON Customer Support for availability.

RILEY™ Options

SPECIFYING INFORMATION

Riley models can be ganged to create seating areas in Office, Education or Health care settings. Using Four different seating models as well as two table styles, the possibilities are limitless. Shown below are the Riley models and examples of ganged seating applications. *NOTE THAT ALL REFERENCES TO SIDE ARE FROM THE SEATED PERSPECTIVE.*

HWGN1



Guest Chair

- May be used as a standalone model or for use with table models HWGNC or HWGNT on either side.
- Not for use in ganging with other seating models. No chair connection on either side.

HWGN2



Starter Gang Chair

- May always be part of a ganged seating solution.
- May be used with HWGN3 or tables HWGNC or HWGNT on the left side.
- Left side no connection, right side holes.

HWGN3



In-Line Gang Chair

- Used for in-line positions only. Not for use in a starting or end position due to exposed connection points.
- Left side dowels & bracket, Right side holes.

HWGN4



End Gang Chair

- Connects only to HWGN2 or HWGN3.
- Must be used in the end position.
- Tables may be connected to the Right side.

HWGN5



Bariatric Single Seat

- Standalone model only.
- May not be ganged with other seating or table models.

HWGNC

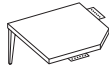

Corner Ganging Table

- For use with models
HWGN1 — Either side
HWGN2 — Left side
HWGN4 — Right side.

HWGNT

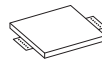

In-Line Ganging Table

- For use with models
HWGN1 — Either side
HWGN2 — Left side
HWGN4 — Right side.

See below for Typical layouts using the models listed above.

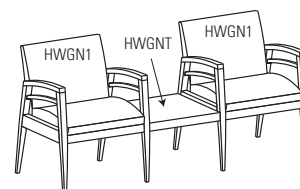
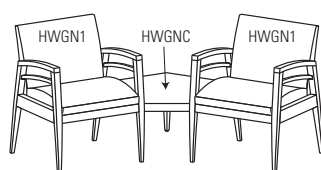
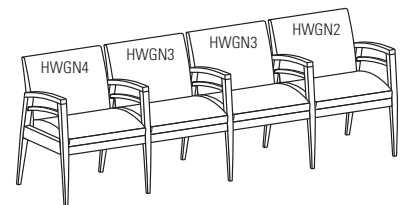
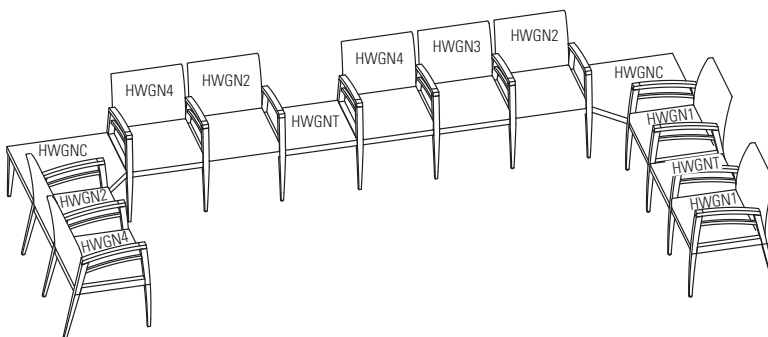



HWGN1



GUEST CHAIR

Leg Base
Arms

DIMENSIONS

| | | | |
|--------------|-----|-----------------------|----------|
| Depth: | 24¼ | Arm Width: | 19⅝ |
| Width: | 23 | Seat to Floor Height: | 19 |
| Height: | 33¼ | Usable Seat Depth: | 17½ |
| Seat Depth: | 17½ | Ship Weight: | 35 |
| Seat Width: | 19⅝ | Cube: | 15.1 |
| Back Width: | 19¾ | COM: | 1.5 |
| Back Height: | 15½ | Weight Rating: | 250 lbs. |

FABRIC PRICE CODES

| | | | |
|----------|--------------|-----------|---------------|
| 1 | \$806 | 8 | \$1013 |
| 2 | \$842 | 9 | \$1040 |
| 3 | \$878 | 10 | \$1067 |
| 4 | \$905 | 11 | \$1094 |
| 5 | \$932 | 12 | \$1121 |
| 6 | \$959 | L | \$1106 |
| 7 | \$986 | | |

NOTES: HWGN1 is a stand alone guest chair that can be used with tables on either side. Coordinating ganging tables available for use with Riley series seating. See page 251.

HWGN2



STARTER GANG CHAIR

Ganging Access on Right Side

DIMENSIONS

| | | | |
|--------------|-----|-----------------------|----------|
| Depth: | 24¼ | Arm Width: | 19⅝ |
| Width: | 23 | Seat to Floor Height: | 19 |
| Height: | 33¼ | Usable Seat Depth: | 17½ |
| Seat Depth: | 17½ | Ship Weight: | 35 |
| Seat Width: | 19⅝ | Cube: | 15.1 |
| Back Width: | 19¾ | COM: | 1.5 |
| Back Height: | 15½ | Weight Rating: | 250 lbs. |

FABRIC PRICE CODES

| | | | |
|----------|--------------|-----------|---------------|
| 1 | \$806 | 8 | \$1013 |
| 2 | \$842 | 9 | \$1040 |
| 3 | \$878 | 10 | \$1067 |
| 4 | \$905 | 11 | \$1094 |
| 5 | \$932 | 12 | \$1121 |
| 6 | \$959 | L | \$1106 |
| 7 | \$986 | | |

NOTES: Start with model HWGN2 for an in-line ganging layout. Add model HWGN3 in between and end with HWGN4 to complete the grouping. Coordinating ganging tables available for use with Riley series seating. See page 251.

HWGN3



IN-LINE GANG LEG CHAIR

Ganging Access on Both Sides

DIMENSIONS

| | | | |
|--------------|-----|-----------------------|----------|
| Depth: | 24¼ | Arm Width: | 19⅝ |
| Width: | 21½ | Seat to Floor Height: | 19 |
| Height: | 33¼ | Usable Seat Depth: | 17½ |
| Seat Depth: | 17½ | Ship Weight: | 30 |
| Seat Width: | 19⅝ | Cube: | 15.1 |
| Back Width: | 19¾ | COM: | 1.5 |
| Back Height: | 15½ | Weight Rating: | 250 lbs. |

FABRIC PRICE CODES

| | | | |
|----------|--------------|-----------|--------------|
| 1 | \$684 | 8 | \$891 |
| 2 | \$720 | 9 | \$918 |
| 3 | \$756 | 10 | \$945 |
| 4 | \$783 | 11 | \$972 |
| 5 | \$810 | 12 | \$999 |
| 6 | \$837 | L | \$984 |
| 7 | \$864 | | |

NOTES: Start with model HWGN2 for an in-line ganging layout. Add model HWGN3 in between and end with HWGN4 to complete the grouping. Coordinating ganging tables available for use with Riley series seating. See page 251.

HON Recommendation: HWGN1.MOCH.CU__ - List Price \$806

HOW TO SPECIFY

| | | |
|--|---|---|
| <p>Select Model Number</p> <p>HWGN1</p> | <p>Select Finish</p> <p>MOCH</p> | <p>Select Fabric</p> <p>CU10</p> |
|--|---|---|



HWGN4



END GANG LEG CHAIR

Gangung Access on Left Side

DIMENSIONS

| | | | |
|--------------|-----|-----------------------|----------|
| Depth: | 24¼ | Arm Width: | 19⅝ |
| Width: | 21½ | Seat to Floor Height: | 19 |
| Height: | 33¼ | Usable Seat Depth: | 17½ |
| Seat Depth: | 17½ | Ship Weight: | 30 |
| Seat Width: | 19⅝ | Cube: | 15.1 |
| Back Width: | 19¾ | COM: | 1.5 |
| Back Height: | 15½ | Weight Rating: | 250 lbs. |

FABRIC PRICE CODES

| | | | |
|---|-------|----|-------|
| 1 | \$684 | 8 | \$891 |
| 2 | \$720 | 9 | \$918 |
| 3 | \$756 | 10 | \$945 |
| 4 | \$783 | 11 | \$972 |
| 5 | \$810 | 12 | \$999 |
| 6 | \$837 | L | \$984 |
| 7 | \$864 | | |

NOTES: Start with model HWGN2 for an in-line gangung layout. Add model HWGN3 in between and end with HWGN4 to complete the grouping. Coordinating gangung tables available for use with Riley series seating. See page 251.

HWGN5



BARIATRIC SINGLE SEAT

Leg Base
Arms

DIMENSIONS

| | | | |
|--------------|-----|-----------------------|----------|
| Depth: | 26½ | Arm Width: | 30¼ |
| Width: | 34 | Seat to Floor Height: | 18½ |
| Height: | 33½ | Usable Seat Depth: | 18 |
| Seat Depth: | 18 | Ship Weight: | 80 |
| Seat Width: | 30¼ | Cube: | 40.6 |
| Back Width: | 30¼ | COM: | 2.5 |
| Back Height: | 18 | Weight Rating: | 500 lbs. |

FABRIC PRICE CODES

| | | | |
|---|--------|----|--------|
| 1 | \$1344 | 8 | \$1689 |
| 2 | \$1404 | 9 | \$1734 |
| 3 | \$1464 | 10 | \$1779 |
| 4 | \$1509 | 11 | \$1824 |
| 5 | \$1554 | 12 | \$1869 |
| 6 | \$1599 | L | \$1844 |
| 7 | \$1644 | | |

NOTES: Coordinating gangung tables available for use with Riley series seating. See page 251.

ⓘ HWGN5 is a Single Seat Bariatric chair warranted to 500 lbs. Not designed to be used for gangung.

HON Recommendation: HWGN5.MOCH.CU__ - List Price \$1344

HOW TO SPECIFY

| | | |
|--|---|---|
| <p>Select Model Number</p> <p>HWGN5</p> | <p>Select Finish</p> <p>See page 245</p> <p>MOCH</p> | <p>Select Fabric</p> <p>See page 245</p> <p>CU10</p> |
|--|---|---|



Icon Legend on page 17

HWGN1B



GUEST CHAIR

Wipe-out Back
Leg Base
Arms

DIMENSIONS

| | | | |
|--------------|-----|-----------------------|----------|
| Depth: | 24¼ | Arm Width: | 19⅝ |
| Width: | 23 | Seat to Floor Height: | 19 |
| Height: | 33¼ | Usable Seat Depth: | 17½ |
| Seat Depth: | 17½ | Ship Weight: | 35 |
| Seat Width: | 19⅝ | Cube: | 15.1 |
| Back Width: | 19¾ | COM: | 2.0 |
| Back Height: | 15½ | Weight Rating: | 250 lbs. |

FABRIC PRICE CODES

| | | | |
|---|--------|----|--------|
| 1 | \$884 | 8 | \$1091 |
| 2 | \$920 | 9 | \$1118 |
| 3 | \$956 | 10 | \$1145 |
| 4 | \$983 | 11 | \$1172 |
| 5 | \$1010 | 12 | \$1199 |
| 6 | \$1037 | L | \$1184 |
| 7 | \$1064 | | |

NOTES: HWGN1B is a stand alone guest chair that can be used with tables on either side.

HWGN2B



STARTER GANG CHAIR

Wipe-out Back
Ganging Access on
Right Side

DIMENSIONS

| | | | |
|--------------|-----|-----------------------|----------|
| Depth: | 24¼ | Arm Width: | 19⅝ |
| Width: | 23 | Seat to Floor Height: | 19 |
| Height: | 33¼ | Usable Seat Depth: | 17½ |
| Seat Depth: | 17½ | Ship Weight: | 35 |
| Seat Width: | 19⅝ | Cube: | 15.1 |
| Back Width: | 19¾ | COM: | 2.0 |
| Back Height: | 15½ | Weight Rating: | 250 lbs. |

FABRIC PRICE CODES

| | | | |
|---|--------|----|--------|
| 1 | \$884 | 8 | \$1091 |
| 2 | \$920 | 9 | \$1118 |
| 3 | \$956 | 10 | \$1145 |
| 4 | \$983 | 11 | \$1172 |
| 5 | \$1010 | 12 | \$1199 |
| 6 | \$1037 | L | \$1184 |
| 7 | \$1064 | | |

NOTES: Start with model HWGN2B for an in-line ganging layout. Add model HWGN3B in between and end with HWGN4B to complete the grouping.

HWGN3B



IN-LINE GANG LEG CHAIR

Wipe-out Back
Ganging Access on
Both Sides

DIMENSIONS

| | | | |
|--------------|-----|-----------------------|----------|
| Depth: | 24¼ | Arm Width: | 19⅝ |
| Width: | 21½ | Seat to Floor Height: | 19 |
| Height: | 33¼ | Usable Seat Depth: | 17½ |
| Seat Depth: | 17½ | Ship Weight: | 30 |
| Seat Width: | 19⅝ | Cube: | 15.1 |
| Back Width: | 19¾ | COM: | 2.0 |
| Back Height: | 15½ | Weight Rating: | 250 lbs. |

FABRIC PRICE CODES

| | | | |
|---|-------|----|--------|
| 1 | \$762 | 8 | \$969 |
| 2 | \$798 | 9 | \$996 |
| 3 | \$834 | 10 | \$1023 |
| 4 | \$861 | 11 | \$1050 |
| 5 | \$888 | 12 | \$1077 |
| 6 | \$915 | L | \$1062 |
| 7 | \$942 | | |

NOTES: Start with model HWGN2B for an in-line ganging layout. Add model HWGN3B in between and end with HWGN4B to complete the grouping.

HON Recommendation: HWGN1B.MOCH.CU__ - List Price \$884

HOW TO SPECIFY

| | | |
|---|---|---|
| <p>Select Model Number</p> <p>HWGN1B</p> | <p>Select Finish</p> <p>MOCH</p> | <p>Select Fabric</p> <p>CU10</p> |
|---|---|---|



HWGN4B



END GANG LEG CHAIR

Wipe-out Back
Ganging Access on
Left Side

DIMENSIONS

| | | | |
|--------------|-----|-----------------------|----------|
| Depth: | 24¼ | Arm Width: | 19⅝ |
| Width: | 21½ | Seat to Floor Height: | 19 |
| Height: | 33¼ | Usable Seat Depth: | 17½ |
| Seat Depth: | 17½ | Ship Weight: | 30 |
| Seat Width: | 19⅝ | Cube: | 15.1 |
| Back Width: | 19¾ | COM: | 2.0 |
| Back Height: | 15½ | Weight Rating: | 250 lbs. |

FABRIC PRICE CODES

| | | | |
|----------|--------------|-----------|---------------|
| 1 | \$762 | 8 | \$969 |
| 2 | \$798 | 9 | \$996 |
| 3 | \$834 | 10 | \$1023 |
| 4 | \$861 | 11 | \$1050 |
| 5 | \$888 | 12 | \$1077 |
| 6 | \$915 | L | \$1062 |
| 7 | \$942 | | |

NOTES: Start with model HWGN2B for an in-line ganging layout. Add model HWGN3B in between and end with HWGN4B to complete the grouping.

HWGN5B

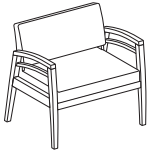

BARIATRIC SINGLE SEAT

Wipe-out Back
Leg Base
Arms

DIMENSIONS

| | | | |
|--------------|-----|-----------------------|----------|
| Depth: | 26½ | Arm Width: | 30¼ |
| Width: | 34 | Seat to Floor Height: | 18½ |
| Height: | 33½ | Usable Seat Depth: | 18 |
| Seat Depth: | 18 | Ship Weight: | 80 |
| Seat Width: | 30¼ | Cube: | 40.6 |
| Back Width: | 30¼ | COM: | 2.5 |
| Back Height: | 18 | Weight Rating: | 500 lbs. |

FABRIC PRICE CODES

| | | | |
|----------|---------------|-----------|---------------|
| 1 | \$1422 | 8 | \$1767 |
| 2 | \$1482 | 9 | \$1812 |
| 3 | \$1542 | 10 | \$1857 |
| 4 | \$1587 | 11 | \$1902 |
| 5 | \$1632 | 12 | \$1947 |
| 6 | \$1677 | L | \$1922 |
| 7 | \$1722 | | |

! HWGN5B is a Single Seat Bariatric chair warranted to 500 lbs. Not designed to be used for ganging.

HON Recommendation: HWGN5B.MOCH.CU__ - List Price \$1422

HOW TO SPECIFY

| | | |
|---|---|---|
| <p>Select Model Number</p> <p>HWGN5B</p> | <p>Select Finish</p> <p>See page 245</p> <p>MOCH</p> | <p>Select Fabric</p> <p>See page 245</p> <p>CU10</p> |
|---|---|---|



HWGNC

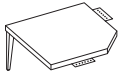

CORNER GANGING TABLE

DIMENSIONS

- Includes leg and two brackets.
- Mounting height — 16”.
- For use with Riley seating models HWGN1, HWGN2 and HWGN4.
- Attaches to Riley seating models for an in-line or corner ganging application.
- Specify wood finish.
- Made from select hardwoods.

| | |
|---------|----|
| Depth: | 28 |
| Width: | 28 |
| Height: | 16 |

| | |
|--------------|-------------|
| Ship Weight: | 48 Ⓢ |
| Cube: | 3.3 |

LIST PRICE

\$658

HWGNT

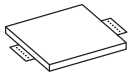

CENTER GANGING TABLE

DIMENSIONS

- Includes two brackets.
- Mounting height — 16”.
- For use with Riley seating models HWGN1, HWGN2 and HWGN4.
- Attaches to Riley seating models for an in-line or corner ganging application.
- Specify wood finish.
- Made from select hardwoods.

| | |
|---------|-----|
| Depth: | 20¼ |
| Width: | 20¼ |
| Height: | 16 |

| | |
|--------------|-------------|
| Ship Weight: | 28 Ⓢ |
| Cube: | 1.7 |

LIST PRICE

\$461

HON Recommendation: HWGNC.MOCH - List Price \$658

HOW TO SPECIFY

| | |
|----------------------------|----------------------|
| Select Model Number | Select Finish |
| | See page 245 |
| HWGNC | MOCH |

SCATTER™ Guest Chairs

OPEN MARKET



Icon Legend on page 17

HVL606



GUEST CHAIR

Leg Base
Armless
Stacks up to Four High

DIMENSIONS

| | | | |
|-------------|-----|-----------------------|-------------|
| Depth: | 21 | Back Height: | 16 |
| Width: | 21¼ | Seat to Floor Height: | 19 |
| Height: | 32¾ | Usable Seat Depth: | 17½ |
| Seat Depth: | 17½ | Ship Weight: | 16 Ⓢ |
| Seat Width: | 19 | Cube: | 2.1 |
| Back Width: | 18½ | Weight Rating: | 250 lbs. |

PRICE CODE

| | |
|----------------|--------------|
| Fabric | \$121 |
| Leather | \$151 |

NOTES: Fabric or Black SofThread™ Leather. Stackable up to four high. Round tube construction. Frame available in Black. **HON 5-Year Limited Warranty.**

HON Recommendation: HVL606.VA10 - List Price \$121

HVL616



GUEST CHAIR

Leg Base
Arms
Stacks up to Four High

DIMENSIONS

| | | | |
|--------------|-----|-----------------------|-------------|
| Depth: | 21 | Arm Width: | 20⅞ |
| Width: | 23¼ | Seat to Floor Height: | 19 |
| Height: | 32¾ | Usable Seat Depth: | 17½ |
| Seat Depth: | 17½ | Ship Weight: | 18 Ⓢ |
| Seat Width: | 19 | Cube: | 2.1 |
| Back Width: | 18½ | Weight Rating: | 250 lbs. |
| Back Height: | 16 | | |

PRICE CODE

| | |
|----------------|--------------|
| Fabric | \$136 |
| Leather | \$166 |

NOTES: Fabric or Black SofThread™ Leather. Stackable up to four high. Round tube construction. Frame available in Black. **HON 5-Year Limited Warranty.**

HON Recommendation: HVL616.VA10 - List Price \$136

HOW TO SPECIFY

| | |
|--|---|
| <p>Select Model Number</p> | <p>Select Fabric</p> <p>SB11 Black SofThread™ Leather VA10 Black Fabric VA19 Charcoal Fabric VA90 Navy Fabric</p> |
| <div style="border: 1px solid black; padding: 2px; display: inline-block;">H V L 6 0 6 .</div> | <div style="border: 1px solid black; padding: 2px; display: inline-block;">V A 1 0</div> |

SMARTLINK®



SmartLink Chairs shown with Build™ Tables.

SMARTLINK®

SmartLink chairs use a responsive, contoured design to support the way students move, allowing them to turn around, sit sideways, lean back and stay comfortable for longer periods of time. The flexible Learning Curve™ design encourages a wider range of movement, keeping students focused and attentive throughout the day. The lightweight frame with casters or glides make it easy to reconfigure the classroom at a moments notice.



FEATURES

- Available in 12 shell colors.
- Available in multiple sizes to accommodate users of all ages.
- Built-in handle makes chairs easy to move.
- Contoured seat back holds a backpack in place.
- High strength tubular steel frame on 4-Leg and Cantilever models.
- 4-leg chairs stack five high.
- Task Swivel Chairs have a pneumatic seat height adjustment.
- Glides available in nylon or nickel plated steel on 4-Leg models.
- Seat Shell is one-piece injection molded.
- Durable textured powder coated paint finish.
- Warranted for users up to 300 lbs.

SMARTLINK® Options

MODEL OPTIONS

HSS4L-16B



4-Leg Chair

6", 12", 14", 16" & 18"H

HSSCL-16B



Cantilever Chair

14", 16" & 18"H

HSSTK-18B



Task Swivel Chair

18"H

HSSST-18B

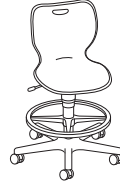

Task Swivel Stool

18"H

4-LEG CASTERS/ GLIDES



| CODE | DESCRIPTION | PRICE |
|----------|-------------|-------------|
| E | Nylon Glide | +\$0 |



| | | |
|----------|--------------------|-------------|
| N | Nickel Steel Glide | +\$0 |
|----------|--------------------|-------------|



| | | |
|----------|--------|---------------|
| C | Caster | +\$196 |
|----------|--------|---------------|

**Available on models HSS4L-16B and HSS4L-18B ONLY*

SHELL COLOR

| CODE | DESCRIPTION | PRICE |
|-----------|-------------|-------------|
| RG | Tangelo | +\$0 |
| CR | Cherry | +\$0 |
| LM | Lime | +\$0 |
| CP | Calypso | +\$0 |
| BU | Surf | +\$0 |
| RE | Regatta | +\$0 |
| MB | Mulberry | +\$0 |
| LO | Loft | +\$0 |
| PT | Platinum | +\$0 |
| SD | Shadow | +\$0 |
| LA | Lava | +\$0 |
| ON | Onyx | +\$0 |

FRAME

| CODE | DESCRIPTION | PRICE |
|-------------|-------------------|--------------|
| PLAT | Platinum Textured | +\$0 |
| P7A | Charcoal Textured | +\$0 |
| Y | Chrome | +\$52 |

**Not available on model HSS4L-06A*

DO NOT SPECIFY FRAME COLOR FOR HSSTK-18B and HSSST-18B

CANTILEVER GLIDES



| CODE | DESCRIPTION | PRICE |
|----------|--------------------------|-------------|
| E | All-purpose Glide Insert | +\$0 |



| | | |
|----------|-------------------|--------------|
| F | Felt Glide Insert | +\$36 |
|----------|-------------------|--------------|

SHELL COLOR

| CODE | DESCRIPTION | PRICE |
|-----------|-------------|-------------|
| RG | Tangelo | +\$0 |
| CR | Cherry | +\$0 |
| LM | Lime | +\$0 |
| CP | Calypso | +\$0 |
| BU | Surf | +\$0 |
| RE | Regatta | +\$0 |
| MB | Mulberry | +\$0 |
| LO | Loft | +\$0 |
| PT | Platinum | +\$0 |
| SD | Shadow | +\$0 |
| LA | Lava | +\$0 |
| ON | Onyx | +\$0 |

FRAME

| CODE | DESCRIPTION | PRICE |
|-------------|-------------------|--------------|
| PLAT | Platinum Textured | +\$0 |
| P7A | Charcoal Textured | +\$0 |
| Y | Chrome | +\$52 |

**Not available on model HSS4L-06A*

DO NOT SPECIFY FRAME COLOR FOR HSSTK-18B and HSSST-18B

TASK CHAIR & STOOL CASTERS/ GLIDES



| CODE | DESCRIPTION | PRICE |
|----------|-------------|-------------|
| S | Soft Caster | +\$0 |



| | | |
|----------|-------------|-------------|
| H | Hard Caster | +\$0 |
|----------|-------------|-------------|



| | | |
|----------|------------|--------------|
| G | Bell Glide | +\$25 |
|----------|------------|--------------|

SHELL COLOR

| CODE | DESCRIPTION | PRICE |
|-----------|-------------|-------------|
| RG | Tangelo | +\$0 |
| CR | Cherry | +\$0 |
| LM | Lime | +\$0 |
| CP | Calypso | +\$0 |
| BU | Surf | +\$0 |
| RE | Regatta | +\$0 |
| MB | Mulberry | +\$0 |
| LO | Loft | +\$0 |
| PT | Platinum | +\$0 |
| SD | Shadow | +\$0 |
| LA | Lava | +\$0 |
| ON | Onyx | +\$0 |

FRAME

| CODE | DESCRIPTION | PRICE |
|-------------|-------------------|--------------|
| PLAT | Platinum Textured | +\$0 |
| P7A | Charcoal Textured | +\$0 |
| Y | Chrome | +\$52 |

**Not available on model HSS4L-06A*

DO NOT SPECIFY FRAME COLOR FOR HSSTK-18B and HSSST-18B

SMARTLINK® Four Leg Chairs

GSA SIN 71-302



Icon Legend on page 17

HSS4L-06A



6" H CHAIR

Four Legs
Armless

DIMENSIONS

| | | | |
|--------------|--------------------------------|-----------------------|--------------------------------|
| Depth: | 17 | Back Width: | 13 ³ / ₈ |
| Width: | 17 | Back Height: | 11 ¹ / ₈ |
| Height: | 17 ¹ / ₂ | Seat to Floor Height: | 6 |
| Seat Depth: | 14 ¹ / ₄ | Usable Seat Depth: | 14 |
| Seat Width: | 14 ⁵ / ₈ | Ship Weight: | 37 Ⓢ |
| Seat Height: | 6 | Cube: | 8.6 |
| | | Weight Rating: | 300 lbs. |

LIST PRICE PER CARTON

\$513
(reference single unit @
\$128.25

NOTES: 4-Leg models stack 5-high on floor. 4-Leg chairs ship 4 per carton. Lead-times may vary by shell color.

ⓘ CA Technical Bulletin 133 compliant shells available in LA-Lava ONLY, ordering instructions below.

ⓘ SmartLink® 4-Leg Chairs are ordered and shipped four (4) chairs per carton. Pricing shown is per carton. Each set of four chairs (one carton) must have the same shell/frame color combination. Ordering 2 of Model HSS4L-06A, HSS4L-12A, HSS4L-14A, HSS4L-16B or HSS4L-18B will result in 2 cartons being shipped, giving you 8 chairs.

HSS4L-12A



12" H CHAIR

Four Legs
Armless

DIMENSIONS

| | | | |
|--------------|--------------------------------|-----------------------|--------------------------------|
| Depth: | 17 | Back Width: | 13 ³ / ₈ |
| Width: | 17 | Back Height: | 11 ¹ / ₈ |
| Height: | 23 ¹ / ₂ | Seat to Floor Height: | 12 |
| Seat Depth: | 14 ¹ / ₄ | Usable Seat Depth: | 14 |
| Seat Width: | 14 ⁵ / ₈ | Ship Weight: | 45 Ⓢ |
| Seat Height: | 12 | Cube: | 11.9 |
| | | Weight Rating: | 300 lbs. |

LIST PRICE PER CARTON

\$526
(reference single unit @
\$131.50

NOTES: 4-Leg models stack 5-high on floor. 4-Leg chairs ship 4 per carton. Lead-times may vary by shell color.

ⓘ CA Technical Bulletin 133 compliant shells available in LA-Lava ONLY, ordering instructions below.

ⓘ SmartLink® 4-Leg Chairs are ordered and shipped four (4) chairs per carton. Pricing shown is per carton. Each set of four chairs (one carton) must have the same shell/frame color combination. Ordering 2 of Model HSS4L-06A, HSS4L-12A, HSS4L-14A, HSS4L-16B or HSS4L-18B will result in 2 cartons being shipped, giving you 8 chairs.

HSS4L-14A



14" H CHAIR

Four Legs
Armless

DIMENSIONS

| | | | |
|--------------|--------------------------------|-----------------------|--------------------------------|
| Depth: | 17 | Back Width: | 13 ³ / ₈ |
| Width: | 17 | Back Height: | 11 ¹ / ₈ |
| Height: | 25 ¹ / ₂ | Seat to Floor Height: | 14 |
| Seat Depth: | 14 ¹ / ₄ | Usable Seat Depth: | 14 |
| Seat Width: | 14 ⁵ / ₈ | Ship Weight: | 49 Ⓢ |
| Seat Height: | 14 | Cube: | 11.9 |
| | | Weight Rating: | 300 lbs. |

LIST PRICE PER CARTON

\$526
(reference single unit @
\$131.50

NOTES: 4-Leg models stack 5-high on floor. 4-Leg chairs ship 4 per carton. Lead-times may vary by shell color.

ⓘ CA Technical Bulletin 133 compliant shells available in LA-Lava ONLY, ordering instructions below.

ⓘ SmartLink® 4-Leg Chairs are ordered and shipped four (4) chairs per carton. Pricing shown is per carton. Each set of four chairs (one carton) must have the same shell/frame color combination. Ordering 2 of Model HSS4L-06A, HSS4L-12A, HSS4L-14A, HSS4L-16B or HSS4L-18B will result in 2 cartons being shipped, giving you 8 chairs.

HOW TO SPECIFY

| | | | |
|---|---|--|---|
| <p>Select Model Number</p> <p>HSS4L-12A .</p> <p>HSS4LFC-12A .</p> | <p>Select Glide Option</p> <p>E Nylon Glide N Nickel Steel Glide C Caster (\$196 upcharge) Caster option not available for models HSS4L-06A, HSS4L-12A or HSS4L-14A</p> <p>E .</p> <p>E .</p> | <p>Select Shell Color</p> <p>RG Tangelo MB Mulberry CR Cherry LO Loft LM Lime PT Platinum CP Calypso SD Shadow BU Surf LA Lava RE Regatta ON Onyx</p> <p>RG .</p> <p>LA .</p> | <p>Select Frame Color</p> <p>PLAT Platinum Textured P7A Charcoal Textured Y Chrome (\$52 upcharge) Y not available on model HSS4L-06A</p> <p>PLAT</p> <p>PLAT</p> |
|---|---|--|---|

🔥 Fire Code Option: For CA Technical Bulletin 133 compliant shells, color limited to LA-Lava. **Add Suffix: FC** to model number as shown above. **Note \$30 upcharge per seat.**



Icon Legend on page 17

SMARTLINK® Four Leg Chairs

HSS4L-16B

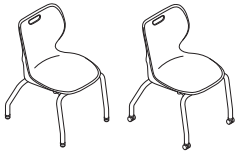

16" H CHAIR

Four Legs
Armless
Functions: (Function Key on pages 18-19)

DIMENSIONS

| | | | |
|--------------|--------------------------------|-----------------------|--------------------------------|
| Depth: | 19 ⁵ / ₈ | Back Width: | 15 ³ / ₈ |
| Width: | 19 ¹ / ₄ | Back Height: | 13 ³ / ₈ |
| Height: | 29 | Seat to Floor Height: | 16 |
| Seat Depth: | 16 ¹ / ₄ | Usable Seat Depth: | 16 ¹ / ₈ |
| Seat Width: | 16 ¹ / ₂ | Ship Weight: | 54 |
| Seat Height: | 16 | Cube: | 15.6 |
| | | Weight Rating: | 300 lbs. |

LIST PRICE PER CARTON

\$554
(reference single unit @
\$138.50)

NOTES: 16" H models accept Wire Storage Basket model HSSA-WB1618. Casters are available on 16" H and 18" H chairs only. 4-Leg models stack 5-high on floor. 4-Leg chairs ship 4 per carton. Lead-times may vary by shell color.

CA Technical Bulletin 133 compliant shells available in LA-Lava ONLY, ordering instructions below.

SmartLink® 4-Leg Chairs are ordered and shipped four (4) chairs per carton. Pricing shown is per carton. Each set of four chairs (one carton) must have the same shell/frame color combination. Ordering 2 of Model HSS4L-06A, HSS4L-12A, HSS4L-14A, HSS4L-16B or HSS4L-18B will result in 2 cartons being shipped, giving you 8 chairs.

HSS4L-18B

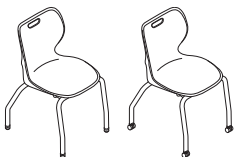

18" H CHAIR

Four Legs
Armless
Functions: (Function Key on pages 18-19)

DIMENSIONS

| | | | |
|--------------|--------------------------------|-----------------------|--------------------------------|
| Depth: | 19 ⁵ / ₈ | Back Width: | 15 ³ / ₈ |
| Width: | 19 ¹ / ₂ | Back Height: | 13 ³ / ₈ |
| Height: | 31 | Seat to Floor Height: | 18 |
| Seat Depth: | 16 ¹ / ₄ | Usable Seat Depth: | 16 ¹ / ₈ |
| Seat Width: | 16 ¹ / ₂ | Ship Weight: | 58 |
| Seat Height: | 18 | Cube: | 15.6 |
| | | Weight Rating: | 300 lbs. |

LIST PRICE PER CARTON

\$554
(reference single unit @
\$138.50)

NOTES: 18" H models accept Wire Storage Basket model HSSA-WB1618. Casters are available on 16" H and 18" H chairs only. 4-Leg models stack 5-high on floor. 4-Leg chairs ship 4 per carton. Lead-times may vary by shell color.

CA Technical Bulletin 133 compliant shells available in LA-Lava ONLY, ordering instructions below.

SmartLink® 4-Leg Chairs are ordered and shipped four (4) chairs per carton. Pricing shown is per carton. Each set of four chairs (one carton) must have the same shell/frame color combination. Ordering 2 of Model HSS4L-06A, HSS4L-12A, HSS4L-14A, HSS4L-16B or HSS4L-18B will result in 2 cartons being shipped, giving you 8 chairs.

HSSA-WB1618

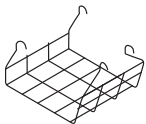

WIRE STORAGE BASKET

DIMENSIONS

| | | | |
|---------|--------------------------------|--------------|-----|
| Depth: | 12 ¹ / ₄ | Ship Weight: | 14 |
| Width: | 15 ³ / ₄ | Cube: | 1.6 |
| Height: | 9 ³ / ₄ | | |

LIST PRICE

\$110

NOTES: Ships 4 per carton.

For 16" and 18" Chairs only. Chrome finish only.

OPEN MARKET

HGDK3-F



GLIDE KIT

| | |
|--------------|-----|
| Ship Weight: | 2 |
| Cube: | 0.2 |

LIST PRICE

\$122

NOTES: For 4-Leg SmartLink®. Recommended for use on VCT flooring. Caps easily and securely snap over the existing nylon swivel glide. Kit includes 100 caps for 25 chairs or desks. Field installed.

Must be ordered with a configurable end product. If ordered separately, not on GSA Contract.

OPEN MARKET

HOW TO SPECIFY

| Select Model Number | Select Glide Option | Select Shell Color | Select Frame Color |
|---|---|--|-------------------------|
| <p>E Nylon Glide N Nickel Steel Glide C Caster (\$196 upcharge) Caster option not available for models HSS4L-06A, HSS4L-12A or HSS4L-14A</p> | <p>RG Tangelo MB Mulberry CR Cherry LO Loft LM Lime PT Platinum CP Calypso SD Shadow BU Surf LA Lava RE Regatta ON Onyx</p> | <p>PLAT Platinum Textured P7A Charcoal Textured Y Chrome (\$52 upcharge) Y not available on model HSS4L-06A</p> | |
| <p>HSS4L-18B</p> <p>HSS4LFC-18B</p> | <p>E</p> <p>E</p> | <p>RG</p> <p>LA</p> | <p>PLAT</p> <p>PLAT</p> |

Fire Code Option: For CA Technical Bulletin 133 compliant shells, color limited to LA-Lava. Add Suffix: FC to model number as shown above. Note \$30 upcharge per seat.

SMARTLINK® Cantilever Chairs

GSA SIN 71-302



Icon Legend on page 17

HSSCL-18B



18" H CHAIR

Cantilever Base
Armless

DIMENSIONS

| | | | |
|--------------|-----|-----------------------|----------|
| Depth: | 21¾ | Back Width: | 15⅝ |
| Width: | 22¾ | Back Height: | 13⅜ |
| Height: | 31¼ | Seat to Floor Height: | 18¼ |
| Seat Depth: | 16⅞ | Usable Seat Depth: | 16⅞ |
| Seat Width: | 16½ | Ship Weight: | 80 |
| Seat Height: | 18 | Cube: | 23.7 |
| | | Weight Rating: | 300 lbs. |

LIST PRICE PER CARTON

\$803
(reference single unit @
\$200.75

NOTES: Cantilever models stack 5-high on floor. Cantilever chairs ship 4 per carton. Lead-times may vary by shell color.

SmartLink® Cantilever Chairs are ordered and shipped four (4) chairs per carton. Pricing shown is per carton. Each set of four chairs (one carton) must have the same shell/frame color combination. Ordering 2 of Model HSSCL-18B will result in 2 cartons being shipped, giving you 8 chairs.

HSSCL-16B



16" H CHAIR

Cantilever Base
Armless

DIMENSIONS

| | | | |
|--------------|-----|-----------------------|----------|
| Depth: | 21¾ | Back Width: | 15⅝ |
| Width: | 22¾ | Back Height: | 13⅜ |
| Height: | 29¼ | Seat to Floor Height: | 16¼ |
| Seat Depth: | 16⅞ | Usable Seat Depth: | 16⅞ |
| Seat Width: | 16½ | Ship Weight: | 55 |
| Seat Height: | 16 | Cube: | 16.8 |
| | | Weight Rating: | 300 lbs. |

LIST PRICE PER CARTON

\$765
(reference single unit @
\$191.25

NOTES: Cantilever models stack 5-high on floor. Cantilever chairs ship 4 per carton. Lead-times may vary by shell color.

SmartLink® Cantilever Chairs are ordered and shipped four (4) chairs per carton. Pricing shown is per carton. Each set of four chairs (one carton) must have the same shell/frame color combination. Ordering 2 of Model HSSCL-18B will result in 2 cartons being shipped, giving you 8 chairs.

HSSCL-14A



14" H CHAIR

Cantilever Base
Armless

DIMENSIONS

| | | | |
|--------------|-----|-----------------------|----------|
| Depth: | 21¾ | Back Width: | 15⅝ |
| Width: | 22¾ | Back Height: | 13⅜ |
| Height: | 27¼ | Seat to Floor Height: | 14¼ |
| Seat Depth: | 16⅞ | Usable Seat Depth: | 16⅞ |
| Seat Width: | 16½ | Ship Weight: | 52 |
| Seat Height: | 14 | Cube: | 16.8 |
| | | Weight Rating: | 300 lbs. |

LIST PRICE PER CARTON

\$750
(reference single unit @
\$187.50

NOTES: Cantilever models stack 5-high on floor. Cantilever chairs ship 4 per carton. Lead-times may vary by shell color.

SmartLink® Cantilever Chairs are ordered and shipped four (4) chairs per carton. Pricing shown is per carton. Each set of four chairs (one carton) must have the same shell/frame color combination. Ordering 2 of Model HSSCL-18B will result in 2 cartons being shipped, giving you 8 chairs.

HOW TO SPECIFY

| | | | |
|---|---|--|--|
| <p>Select Model Number</p> <p>HSSCL-18B</p> <p>HSSCLFC-18B</p> | <p>Select Glide Option</p> <p>E All-purpose Glide Insert (no upcharge) F Felt Glide Insert (\$36 list upcharge; \$9 per single unit)</p> <p>E</p> <p>E</p> | <p>Select Shell Color</p> <p>RG Tangelo MB Mulberry CR Cherry LO Loft LM Lime PT Platinum CP Calypso SD Shadow BU Surf LA Lava RE Regatta ON Onyx</p> <p>RG</p> <p>LA</p> | <p>Select Frame Color</p> <p>PLAT Platinum Textured P7A Charcoal Textured Y Chrome (\$52 upcharge)</p> <p>PLAT</p> <p>PLAT</p> |
|---|---|--|--|

Fire Code Option: For CA Technical Bulletin 133 compliant shells, color limited to LA-Lava. **Add Suffix: FC** to model number as shown above. **Note \$32.25 upcharge per seat.**



HSSTK-18B

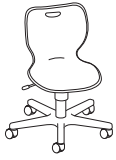

18" H TASK CHAIR

Pneumatic
Swivel

DIMENSIONS

| | | | |
|--------------|--------------------------------|-----------------------|--------------------------------|
| Depth: | 22 ⁵ / ₈ | Back Width: | 15 ³ / ₈ |
| Width: | 22 ¹ / ₂ | Back Height: | 13 ³ / ₈ |
| Height: | 34 ³ / ₄ | Seat to Floor Height: | 16-21 |
| Seat Depth: | 16 ¹ / ₄ | Usable Seat Depth: | 16 ¹ / ₈ |
| Seat Width: | 16 ¹ / ₂ | Ship Weight: | 23 |
| Seat Height: | 18 | Cube: | 5.2 |
| | | Weight Rating: | 300 lbs. |

LIST PRICE PER CARTON

\$262

NOTES: Task Swivel Chair has a pneumatic seat height adjustment. Swivel Task Chair and Stool ship one per carton. Lead-times may vary by shell color.

ⓘ Black frame only.

HSSST-18B

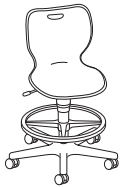

18" H TASK STOOL

Pneumatic
Swivel
Adjustable Footring

DIMENSIONS

| | | | |
|--------------|--------------------------------|-----------------------|--------------------------------|
| Depth: | 24 ¹ / ₄ | Back Width: | 15 ³ / ₈ |
| Width: | 25 ³ / ₄ | Back Height: | 13 ³ / ₈ |
| Height: | 45 ¹ / ₂ | Seat to Floor Height: | 22-32 |
| Seat Depth: | 16 ¹ / ₄ | Usable Seat Depth: | 16 ¹ / ₈ |
| Seat Width: | 16 ¹ / ₂ | Ship Weight: | 28 |
| Seat Height: | 18 | Cube: | 12.8 |
| | | Weight Rating: | 300 lbs. |

LIST PRICE PER CARTON

\$352

NOTES: Stool has an adjustable footring. Swivel Task Chair and Stool ship one per carton. Lead-times may vary by shell color.

ⓘ Black frame only.

HOW TO SPECIFY

Select Model Number

H S S T K - 1 8 B

Select Glide Option

- S** Soft Caster (no upcharge)
- H** Hard Caster (no upcharge)
- G** Bell Glide (\$25 upcharge)

S

Select Shell Color

- | | |
|-------------------|--------------------|
| RG Tangelo | MB Mulberry |
| CR Cherry | LO Loft |
| LM Lime | PT Platinum |
| CP Calypso | SD Shadow |
| BU Surf | LA Lava |
| RE Regatta | ON Onyx |

RG

SOLUTIONS SEATING® 4000 SERIES



Solutions Managerial Mid-Back Chair shown with 34000 Series Desk and Brigade® 700 Series Lateral Files.

SOLUTIONS SEATING® 4000 SERIES

Looking for the perfect answer for your task and guest chair needs? HON has four Solutions for everything from workstations to open areas. The Solutions series includes a high-back and mid-back task chair, as well as matching four-leg and sled base guest chairs. The floating backrest provides ergonomic support for your spine. The tilt mechanism delivers a natural recline. Solutions are the chairs that really live up to their name.



TASK CHAIR FEATURES

- One-touch seat height adjustment easily moves the seat up and down.
- Tilt tension controls the rate and ease of recline.
- Tilt lock allows the user to lock out the tilt function.
- 360-degree swivel provides freedom of movement in any direction.
- Model H4001 has a fully-upholstered outer back.
- Model H4002 has a molded polymer outer back shell color to match the base.
- Back cushion enhances lumbar support and minimizes fatigue.
- Dual-wheeled, hooded casters roll effortlessly and quietly.
- Available in hundreds of quality HON fabrics.
- Warranted for users up to 300 lbs.

GUEST CHAIR FEATURES

- Molded polymer outer back shell color matches the base.
- Back cushion enhances lumbar support and minimizes fatigue.
- Available in hundreds of quality HON fabrics.
- Warranted for users up to 300 lbs.

SOLUTIONS SEATING®

4000 Series Options

MODEL OPTIONS

H4001



Executive High-Back

Pneumatic, Swivel, Tilt, Tilt Tension, Tilt Lock, Loop Arms

H4002



Managerial Mid-Back

Pneumatic, Swivel, Tilt, Tilt Tension, Tilt Lock, Loop Arms

H4003



Guest Chair

Leg Base, Arms

H4008



Guest Chair

Sled Base, Arms

CASTERS



| CODE | DESCRIPTION | PRICE |
|------|-------------|-------------|
| H | Hard Caster | +\$0 |



| | | |
|---|-------------|--------------|
| S | Soft Caster | +\$30 |
|---|-------------|--------------|

*Specify for models H4001 and H4002 only

FRAME

| CODE | DESCRIPTION | PRICE |
|------|-------------|-------------|
| T | Black | +\$0 |

HON BRANDED FABRICS

GRADE 1

Attire
Centurion
Compass
Contourette Polyurethane
Dapper
Hamilton
Inertia
Optic

GRADE 2

Appoint Seating
Clyde
Dotty
Rush
Seed
Spin Seating
Whisper Vinyl

GRADE 3

In Season
Purl
Silvertex™ Vinyl

For a complete list of fabrics, including partnership fabrics, go to hon.com/fabricsandfinishes.

Reference Fabric Color Combinations on pages 20-24 for color codes and legend on page 21 for lead times. COM yardage shown is for Pattern Cut only. Contact Customer Service for Railroaded yardage requirements. For additional HON to Supply COM fabric grade pricing, go to honready.hon.com and click on the HON to Supply COM link.

For Fire Code model, availability and ordering method, refer to pages 28-31. Available on select models, contact HON Customer Support for availability.

SOLUTIONS SEATING®

4000 Series

GSA SIN 711-18



Icon Legend on page 17

H4001



EXECUTIVE HIGH-BACK

Pneumatic
Swivel
Tilt
Tilt Tension
Tilt Lock
Loop Arms
Functions: **A, E, F, K, L**
(Function Key on pages 18-19)

DIMENSIONS

Depth: 27
Width: 26
Height: 39³/₄
Seat Depth: 18
Seat Width: 20
Back Width: 20¹/₂
Back Height: 20³/₄
Arm Width: 20¹/₄
Seat to Floor Height: 16³/₄-21³/₄
Usable Seat Depth: 17³/₄
Ship Weight: 45
Cube: 10.3
COM: 1.5
Weight Rating: 250 lbs.

FABRIC PRICE CODES

| | | | |
|---|-------|----|-------|
| 1 | \$432 | 8 | \$639 |
| 2 | \$468 | 9 | \$666 |
| 3 | \$504 | 10 | \$693 |
| 4 | \$531 | 11 | \$720 |
| 5 | \$558 | 12 | \$747 |
| 6 | \$585 | L | — |
| 7 | \$612 | | |

H4002



MANAGERIAL MID-BACK

Pneumatic
Swivel
Tilt
Tilt Tension
Tilt Lock
Loop Arms
Functions: **A, E, F, K, L**
(Function Key on pages 18-19)

DIMENSIONS

Depth: 26¹/₄
Width: 26
Height: 35¹/₂
Seat Depth: 18
Seat Width: 20
Back Width: 21
Back Height: 15
Arm Width: 18³/₄
Seat to Floor Height: 16³/₄-21³/₄
Usable Seat Depth: 17³/₄
Ship Weight: 38
Cube: 8.6
COM: 1.0
Weight Rating: 250 lbs.

FABRIC PRICE CODES

| | | | |
|---|-------|----|-------|
| 1 | \$391 | 8 | \$529 |
| 2 | \$415 | 9 | \$547 |
| 3 | \$439 | 10 | \$565 |
| 4 | \$457 | 11 | \$583 |
| 5 | \$475 | 12 | \$601 |
| 6 | \$493 | L | — |
| 7 | \$511 | | |

H4003



GUEST CHAIR

Leg Base
Arms

DIMENSIONS

Depth: 24¹/₂
Width: 23¹/₂
Height: 32
Seat Depth: 18
Seat Width: 20
Back Width: 21
Back Height: 15
Arm Width: 18³/₄
Seat to Floor Height: 19¹/₄
Usable Seat Depth: 18¹/₄
Ship Weight: 29
Cube: 12.6
COM: 1.0
Weight Rating: 250 lbs.

FABRIC PRICE CODES

| | | | |
|---|-------|----|-------|
| 1 | \$295 | 8 | \$433 |
| 2 | \$319 | 9 | \$451 |
| 3 | \$343 | 10 | \$469 |
| 4 | \$361 | 11 | \$487 |
| 5 | \$379 | 12 | \$505 |
| 6 | \$397 | L | — |
| 7 | \$415 | | |

H4008



GUEST CHAIR

Sled Base
Arms

DIMENSIONS

Depth: 25¹/₂
Width: 23¹/₂
Height: 32¹/₂
Seat Depth: 18
Seat Width: 20
Back Width: 21
Back Height: 15
Arm Width: 19
Seat to Floor Height: 19¹/₄
Usable Seat Depth: 18¹/₄
Ship Weight: 33
Cube: 12.6
COM: 1.0
Weight Rating: 250 lbs.

FABRIC PRICE CODES

| | | | |
|---|-------|----|-------|
| 1 | \$328 | 8 | \$466 |
| 2 | \$352 | 9 | \$484 |
| 3 | \$376 | 10 | \$502 |
| 4 | \$394 | 11 | \$520 |
| 5 | \$412 | 12 | \$538 |
| 6 | \$430 | L | — |
| 7 | \$448 | | |

HON Recommendation: H4001.H.CU__T - List Price \$432

H4008.CU__T - List Price \$328

HOW TO SPECIFY

| | | | |
|--|--|--|--|
| <p>Select Model Number</p> <p>H 4 0 0 8 .</p> | <p>Select Caster</p> <p>H Hard Caster S Soft Caster (+ \$30) Specify for models H4001 and H4002 only</p> <p>H .</p> | <p>Select Fabric</p> <p>See page 261</p> <p>C U 1 0 .</p> | <p>Select Frame</p> <p>T Black</p> <p>T</p> |
|--|--|--|--|

SOLVE®



Solve Task Chairs and Stools.

SOLVE®

If you want to make a powerful statement, simply have a seat. With three back materials and an optional adjustable lumbar support, Solve answers the need for a higher level of personalization. Solve task chairs feature a geometric ReActiv® back to create a contemporary look, while the ilira®-stretch mesh back offers a softer, more relaxed feel. The synchronized seat and back move in harmony with the user to provide continuous comfort that can be customized. Helping anyone achieve optimal balance, proper alignment and lumbar support, Solve is an ideal solution for everywhere and everybody.



FEATURES

- Synchronized seat and back create continuous comfort.
- ilira®-stretch mesh back is available in five colors.
- Waterfall seat edge encourages leg circulation.
- Seat depth adjustment adapts to users of various heights.
- ReActiv® back design moves with your body to provide continuous support and airflow for lasting comfort.
- Choose one of three control types — synchro-tilt, synchro-tilt with seat slider and advanced synchro-tilt.
- Choose armless or height- and width-adjustable arms.
- Available with bell glides, hard casters or soft casters.
- Upholstered ReActiv® back offers all the benefits of the ReActiv® back with a fabric cover for additional comfort.
- Back upholstery available in one of six attractive fabrics.
- Optional integrated lumbar support delivers long-lasting comfort.
- Choose from 3 frame options: black, titanium or white.
- Warranted for users up to 300 lbs.

SOLVE[®] Options

MODEL OPTIONS

HSLVTMM



Mid-Back Task (Ilira[®]-stretch Back)

Pneumatic, Swivel, Synchro-tilt,
Tilt Tension, Tilt Lock

HSLVSMM



Stool (Ilira[®]-stretch Back)

Pneumatic, Swivel, Synchro-tilt,
Tilt Tension, Tilt Lock

HSLVTMMS



**Mid-Back Task (Ilira[®]-stretch Back)
with Designer White frame**

Pneumatic, Swivel, Synchro-tilt,
Tilt Tension, Tilt Lock

HSLVSMMS



**Stool (Ilira[®]-stretch Back) with
Designer White frame**

Pneumatic, Swivel, Synchro-tilt,
Tilt Tension, Tilt Lock

HSLVTMR



Mid-Back Task (ReActiv[®] Back)

Pneumatic, Swivel, Synchro-tilt,
Tilt Tension, Tilt Lock

HSLVSMR



Stool (ReActiv[®] Back)

Pneumatic, Swivel, Synchro-tilt,
Tilt Tension, Tilt Lock

HSLVTMRS



**Mid-Back Task (ReActiv[®] Back)
with Designer White frame**

Pneumatic, Swivel, Synchro-tilt,
Tilt Tension, Tilt Lock

HSLVSMRS



**Stool (ReActiv[®] Back) with
Designer White frame**

Pneumatic, Swivel, Synchro-tilt,
Tilt Tension, Tilt Lock

HSLVTMU



Mid-Back Task (Upholstered Back)

Pneumatic, Swivel, Synchro-tilt,
Tilt Tension, Tilt Lock

HSLVSMU



Stool (Upholstered Back)

Pneumatic, Swivel, Synchro-tilt,
Tilt Tension, Tilt Lock

HSLVTMUS



**Mid-Back Task (Upholstered Back)
with Designer White frame**

Pneumatic, Swivel, Synchro-tilt,
Tilt Tension, Tilt Lock

HSLVSMUS







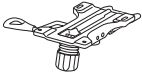
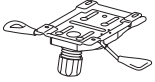
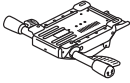

**Stool (Upholstered Back) with
Designer White frame**

Pneumatic, Swivel, Synchro-tilt,
Tilt Tension, Tilt Lock

| MECHANISM | CODE | DESCRIPTION | PRICE |
|---|-----------|--|--------------|
|  | Y0 | Synchro-Tilt A, E, J, K, L | +\$0 |
|  | Y1 | Synchro-Tilt w/Seat Slider A, D, E, J, K, L | +\$20 |
|  | Y2 | Advanced Synchro-Tilt A, D, E, J, L, A-D | +\$65 |

**Y2 control not available on stool models*

| ARM STYLE | CODE | DESCRIPTION | PRICE |
|---|----------|---|---------------|
| | N | Armless | +\$0 |
|  | F | Fixed Arms | +\$65 |
|  | A | Height and Width Adjustable Arms | +\$75 |
|  | V | All-Adjustable Arms (includes Pivot) | +\$115 |

| CASTERS/ GLIDE | CODE | DESCRIPTION | PRICE |
|---|----------|---------------------|--------------|
|  | H | Hard Caster | +\$0 |
|  | S | Soft Caster | +\$30 |
|  | R | Roll Control Caster | +\$50 |
|  | G | Bell Glide | +\$25 |

| BACK STYLE | CODE | DESCRIPTION | PRICE |
|---|---------------|---|-------------|
| | | <i>ilira[®]-stretch mesh back options:</i> | |
|  | IM | Black | +\$0 |
| | IF | Fog | +\$0 |
| | IC | Charcoal | +\$0 |
| | IH | Chai | +\$0 |
| | IY | Navy | +\$0 |
| | | <i>ReActiv[®] back options:</i> | |
|  | OS | Charcoal | +\$0 |
| | DW | Designer White | +\$0 |
| | TI | Titanium | +\$0 |
| | | <i>Fabric options:</i> | |
|  | COMF46 | Bittersweet | +\$0 |
| | COMF10 | Ink | +\$0 |
| | COMF82 | Meadow | +\$0 |
| | COMF90 | Midnight | +\$0 |
| | COMF22 | Putty | +\$0 |
| | COMF19 | Sterling | +\$0 |

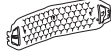
| LUMBAR | CODE | DESCRIPTION | PRICE |
|---|-----------|----------------------------------|--------------|
| | NL | No Lumbar | +\$0 |
|  | BL | Black Adjustable Lumbar | +\$30 |
| | BY | Bullseye Adjustable Lumbar | +\$30 |
| | DW | Designer White Adjustable Lumbar | +\$30 |
| | KT | Krypton Adjustable Lumbar | +\$30 |
| | MR | Ember Adjustable Lumbar | +\$30 |
| | RE | Regatta Adjustable Lumbar | +\$30 |
| | TL | Titanium Adjustable Lumbar | +\$30 |

| BASE | CODE | DESCRIPTION | PRICE |
|---|-----------|---------------|-------------|
|  | SB | Standard Base | +\$0 |

| FRAME | CODE | DESCRIPTION | PRICE |
|-------|-----------|----------------|--------------|
| | T | Black | +\$0 |
| | TI | Titanium | +\$35 |
| | DW | Designer White | +\$35 |

HON BRANDED FABRICS

GRADE 1

Attire
Centurion
Compass
Compass Foam
Contourette Polyurethane
Dapper
Hamilton
Inertia
Optic

GRADE 2

Appoint Seating
Clyde
Dotty
Rush
Seed
Spin Seating
Whisper Vinyl

GRADE 3

In Season
Purl
Silvertex™ Vinyl

GRADE L

Denver Leather
(Seat Only)

For a complete list of fabrics, including partnership fabrics, go to hon.com/fabricsandfinishes.

Reference Fabric Color Combinations on pages 20-24 for color codes and legend on page 21 for lead times.

🔥 For Fire Code model, availability and ordering method, refer to pages 28-31. Available on select models, contact HON Customer Support for availability.

DIMENSIONS

NOTE: When selecting the .TI Titanium or .DW Designer White frame option, the chair's back frame, arms, and base will come as titanium. ilira[®], ReActiv[®], and/or lumbar color must be selected separately.

| MODEL | | HSLVTMM /HSLVTMMS | HSLVSM /HSLVSMMS | HSLVTMR /HSLVTMRS | HSLVSMR /HSLVSMRS | HSLVTMU /HSLVTMUS | HSLVSMU /HSLVSMUS |
|-------------------------|----------------------|--------------------------------|------------------------|--------------------------------|------------------------|--------------------------------|------------------------|
| Overall Width Armless | | 29½" | 29½" | 29½" | 29½" | 29½" | 29½" |
| Overall Width with Arms | (A) | 29½" | 29½" | 29½" | 29½" | 29½" | 29½" |
| Overall Depth | | 29½" | 29½" | 29½" | 29½" | 29½" | 29½" |
| Overall Height – Max | (Y0/Y1) (Y2) | 41¾" 42½" | 52¾" — | 41¾" 42½" | 52¾" — | 41¾" 42½" | 52¾" — |
| Seat Width | | 19" | 19" | 19" | 19" | 19" | 19" |
| Seat Depth (Cushion) | | 19¼" | 19¼" | 19¼" | 19¼" | 19¼" | 19¼" |
| Usable Seat Depth | (Y0) (Y1) (Y2) | 17⅝" 16¼"-18½" 16¼"-19¼" | 17⅝" 16¼"-18½" — | 17⅝" 16¼"-18½" 16¼"-19¼" | 17⅝" 16¼"-18½" — | 17⅝" 16¼"-18½" 16¼"-19¼" | 17⅝" 16¼"-18½" — |
| Seat Height | (Y0/Y1) (Y2) | 16¾"-21¾" 17½"-22½" | 22¾"-32¾" — | 16¾"-21¾" 17½"-22½" | 22¾"-32¾" — | 16¾"-21¾" 17½"-22½" | 22¾"-32¾" — |
| Back Width | | 18¼" | 18¼" | 18¼" | 18¼" | 18¼" | 18¼" |
| Back Height | | 22⅜" | 22⅜" | 22⅜" | 22⅜" | 22⅜" | 22⅜" |
| Ship Weight Armless | (Y0) (Y1) (Y2) | 40 Ⓢ 42 Ⓢ 45 Ⓢ | 45 Ⓢ 47 Ⓢ — | 41 Ⓢ 43 Ⓢ 46 Ⓢ | 46 Ⓢ 48 Ⓢ — | 41 Ⓢ 43 Ⓢ 46 Ⓢ | 46 Ⓢ 48 Ⓢ — |
| Ship Weight with Arms | (Y0) (Y1) (Y2) | 44 Ⓢ 46 Ⓢ 49 Ⓢ | 49 Ⓢ 51 Ⓢ — | 45 Ⓢ 47 Ⓢ 50 Ⓢ | 50 Ⓢ 52 Ⓢ — | 45 Ⓢ 47 Ⓢ 50 Ⓢ | 50 Ⓢ 52 Ⓢ — |
| Width Between Arms | | 17½"-20" | 17½"-20" | 17½"-20" | 17½"-20" | 17½"-20" | 17½"-20" |
| COM | | 1.0 | 1.0 | 1.0 | 1.0 | 1.0 | 1.0 |
| Weight Capacity | | 300 lbs | 300 lbs | 300 lbs | 300 lbs | 300 lbs | 300 lbs |



HSLVTMM

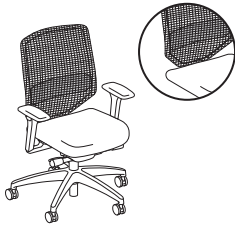

MID-BACK TASK

- ilira[®]-stretch Back**
- Pneumatic
- Swivel
- Synchro-tilt
- Tilt Tension
- Tilt Lock

DIMENSIONS

- Seat Depth: 19¼
- Seat Width: 19
- Back Width: 18¼
- Back Height: 22½
- Arm Width: 17½-20
- Cube: 7.6
- Weight Rating: 300 lbs.

FABRIC PRICE CODES

- | | | | |
|---|-------|----|-------|
| 1 | \$446 | 8 | \$515 |
| 2 | \$458 | 9 | \$524 |
| 3 | \$470 | 10 | \$533 |
| 4 | \$479 | 11 | \$542 |
| 5 | \$488 | 12 | \$551 |
| 6 | \$497 | L | \$546 |
| 7 | \$506 | | |

NOTES: Please reference pages 265-266 for additional specifications and mechanism information.

HSLVSMM



STOOL

- ilira[®]-stretch Back**
- Pneumatic
- Swivel
- Synchro-tilt
- Tilt Tension
- Tilt Lock

DIMENSIONS

- Seat Depth: 19¼
- Seat Width: 19
- Back Width: 18¼
- Back Height: 22½
- Arm Width: 17½-20
- Cube: 7.6
- Weight Rating: 300 lbs.

FABRIC PRICE CODES

- | | | | |
|---|-------|----|-------|
| 1 | \$500 | 8 | \$569 |
| 2 | \$512 | 9 | \$578 |
| 3 | \$524 | 10 | \$587 |
| 4 | \$533 | 11 | \$596 |
| 5 | \$542 | 12 | \$605 |
| 6 | \$551 | L | \$600 |
| 7 | \$560 | | |

NOTES: Please reference pages 265-266 for additional specifications and mechanism information.

HON Recommendation: HSLVTMM.Y1.A.S.IM.CU__BL.SB.T - List Price \$601

HOW TO SPECIFY

| Select Model Number | Select Control Type | Select Arm Type | Select Caster/Glide | Select Mesh Back | Select Fabric | Select Lumbar | Select Base | Select Frame |
|---------------------|--|---|---|---|---------------|--|-------------------------|---|
| | Y0 Synchro-Tilt Y1 Synchro-Tilt w/ Seat Slider (+ \$20) Y2 Advanced Synchro-Tilt (+ \$65) <i>Y2 not available on stool</i> | N Armless F Fixed Arms (+ \$65) A Height and Width Adjustable Arms (+ \$75) V All-Adjustable Arms (includes pivot) (+ \$115) | H Hard Caster (+ \$30) S Soft Caster (+ \$30) G Bell Glide (+ \$25) R Roll Control Caster (+ \$50) | ilira [®] -stretch options IM Black IF Fog IC Charcoal IH Chai IY Navy | See page 266 | NL No Lumbar BL Black Adjustable Lumbar (+ \$30) BY Bullseye Adjustable Lumbar (+ \$30) DW Designer White Adjustable Lumbar (+ \$30) KT Krypton Adjustable Lumbar (+ \$30) MR Ember Adjustable Lumbar (+ \$30) RE Regatta Adjustable Lumbar (+ \$30) TL Titanium Adjustable Lumbar (+ \$30) | SB Standard Base | T Black TI Titanium (+ \$35) |
| H S L V T M M . | Y 1 . | A . | S . | I M . | C U 1 0 . | B L . | S B . | T |



HSLVTMR

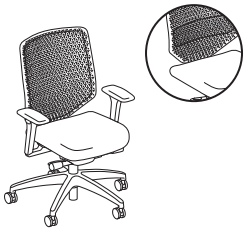

MID-BACK TASK

ReActiv® Back
Pneumatic
Swivel
Synchro-tilt
Tilt Tension
Tilt Lock

DIMENSIONS

Seat Depth: 19¼ Arm Width: 17½-20
Seat Width: 19 Cube: 7.6
Back Width: 18¼ Weight Rating: 300 lbs.
Back Height: 22¾

FABRIC PRICE CODES

| | | | |
|---|-------|----|-------|
| 1 | \$476 | 8 | \$545 |
| 2 | \$488 | 9 | \$554 |
| 3 | \$500 | 10 | \$563 |
| 4 | \$509 | 11 | \$572 |
| 5 | \$518 | 12 | \$581 |
| 6 | \$527 | L | \$576 |
| 7 | \$536 | | |

NOTES: Please reference pages 265-266 for additional specifications and mechanism information.

HSLVSMR

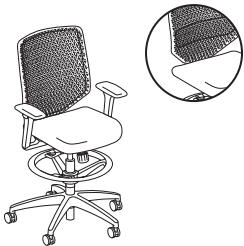

STOOL

ReActiv® Back
Pneumatic
Swivel
Synchro-tilt
Tilt Tension
Tilt Lock

DIMENSIONS

Seat Depth: 19¼ Arm Width: 17½-20
Seat Width: 19 Cube: 7.6
Back Width: 18¼ Weight Rating: 300 lbs.
Back Height: 22¾

FABRIC PRICE CODES

| | | | |
|---|-------|----|-------|
| 1 | \$530 | 8 | \$599 |
| 2 | \$542 | 9 | \$608 |
| 3 | \$554 | 10 | \$617 |
| 4 | \$563 | 11 | \$626 |
| 5 | \$572 | 12 | \$635 |
| 6 | \$581 | L | \$630 |
| 7 | \$590 | | |

NOTES: Please reference pages 265-266 for additional specifications and mechanism information.

HON Recommendation: HSLVTMR.Y1.A.H.OS.CU__NL.SB.T - List Price \$571

HOW TO SPECIFY

| Select Model Number | Select Control Type | Select Arm Type | Select Caster/Glide | Select Back Color | Select Fabric | Select Lumbar | Select Base | Select Frame |
|--|---|--|--|-------------------|--|-------------------------|---|--------------|
| Y0 Synchro-Tilt Y1 Synchro-Tilt w/ Seat Slider (+ \$20) Y2 Advanced Synchro-Tilt (+ \$65) <i>Y2 not available on stool</i> | N Armless F Fixed Arms (+ \$65) A Height and Width Adjustable Arms (+ \$75) V All-Adjustable Arms (includes pivot) (+ \$115) | H Hard Caster S Soft Caster (+ \$30) G Bell Glide (+ \$25) R Roll Control Caster (+ \$50) | OS Charcoal TI Titanium DW Designer White | See page 266 | NL No Lumbar BL Black Adjustable Lumbar (+ \$30) BY Bullseye Adjustable Lumbar (+ \$30) DW Designer White Adjustable Lumbar (+ \$30) KT Krypton Adjustable Lumbar (+ \$30) MR Ember Adjustable Lumbar (+ \$30) RE Regatta Adjustable Lumbar (+ \$30) TL Titanium Adjustable Lumbar (+ \$30) | SB Standard Base | T Black TI Titanium (+ \$35) | |
| H S L V T M R . | Y 1 . | A . | H . | O S . | C U 1 0 . | N L . | S B . | T |



HSLVTMU

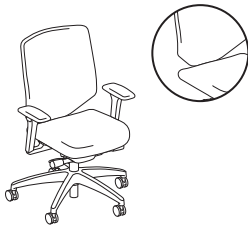

MID-BACK TASK

- Upholstered Back**
- Pneumatic
- Swivel
- Synchro-tilt
- Tilt Tension
- Tilt Lock

DIMENSIONS

- Seat Depth: 19¼
- Seat Width: 19
- Back Width: 18¼
- Back Height: 22½
- Arm Width: 17½-20
- Cube: 7.6
- Weight Rating: 300 lbs.

FABRIC PRICE CODES

- | | | | |
|---|-------|----|-------|
| 1 | \$491 | 8 | \$560 |
| 2 | \$503 | 9 | \$569 |
| 3 | \$515 | 10 | \$578 |
| 4 | \$524 | 11 | \$587 |
| 5 | \$533 | 12 | \$596 |
| 6 | \$542 | L | \$591 |
| 7 | \$551 | | |

NOTES: Please reference pages 265-266 for additional specifications and mechanism information.

HSLVSMU

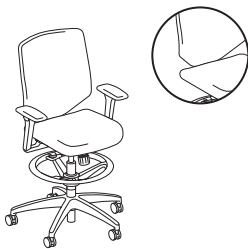

STOOL

- Upholstered Back**
- Pneumatic
- Swivel
- Synchro-tilt
- Tilt Tension
- Tilt Lock

DIMENSIONS

- Seat Depth: 19¼
- Seat Width: 19
- Back Width: 18¼
- Back Height: 22½
- Arm Width: 17½-20
- Cube: 7.6
- Weight Rating: 300 lbs.

FABRIC PRICE CODES

- | | | | |
|---|-------|----|-------|
| 1 | \$545 | 8 | \$614 |
| 2 | \$557 | 9 | \$623 |
| 3 | \$569 | 10 | \$632 |
| 4 | \$578 | 11 | \$641 |
| 5 | \$587 | 12 | \$650 |
| 6 | \$596 | L | \$645 |
| 7 | \$605 | | |

NOTES: Please reference pages 265-266 for additional specifications and mechanism information.

HON Recommendation: HSLVTMU.Y1.A.H.OS.COMF10.COMP10.NL.SB.T - List Price \$586

HOW TO SPECIFY

| Select Model Number | Select Control Type | Select Arm Type | Select Caster/Glide | Select Back Color | Select Back Fabric | Select Seat Fabric | Select Lumbar | Select Base | Select Frame |
|---------------------|--|---|--|--|---|--------------------|--|-------------------------|---|
| | Y0 Synchro-Tilt Y1 Synchro-Tilt w/ Seat Slider (+ \$20) Y2 Advanced Synchro-Tilt (+ \$65) <i>Y2 not available on stool</i> | N Armless F Fixed Arms (+ \$65) A Height and Width Adjustable Arms (+ \$75) V All-Adjustable Arms (includes pivot) (+ \$115) | H Hard Caster S Soft Caster (+ \$30) G Bell Glide (+ \$25) R Roll Control Caster (+ \$50) | OS Charcoal TI Titanium DW Designer White | COMF46 Bittersweet COMF10 Ink COMF82 Meadow COMF90 Midnight COMF22 Putty COMF19 Sterling | See page 266 | NL No Lumbar BL Black Adjustable Lumbar (+ \$30) BY Bullseye Adjustable Lumbar (+ \$30) DW Designer White Adjustable Lumbar (+ \$30) KT Krypton Adjustable Lumbar (+ \$30) MR Ember Adjustable Lumbar (+ \$30) RE Regatta Adjustable Lumbar (+ \$30) TL Titanium Adjustable Lumbar (+ \$30) | SB Standard Base | T Black TI Titanium (+ \$35) |
| H S L V T M U . | Y 1 . | A . | H . | O S . | C O M F 1 0 . | C O M P 1 0 . | N L . | S B . | T |



HSLVTMMKD

MID-BACK TASK

DIMENSIONS

FABRIC PRICE CODES

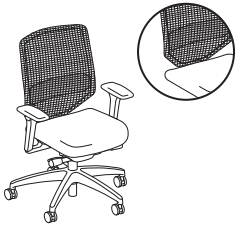

ilira®-stretch Back
Pneumatic
Swivel
Synchro-tilt
Tilt Tension
Tilt Lock

Seat Depth: 19¼ Arm Width: 17½-20
Seat Width: 19 Cube: 7.6
Back Width: 18¼ Weight Rating: 300 lbs.
Back Height: 22¾

1 \$406
2 \$418
3 \$430

NOTES: Please reference pages 265-266 for additional specifications and mechanism information.

HSLVTMRKD

MID-BACK TASK

DIMENSIONS

FABRIC PRICE CODES

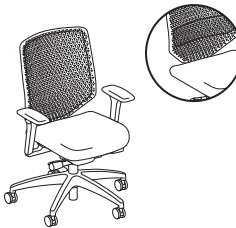

ReActiv® Back
Pneumatic
Swivel
Synchro-tilt
Tilt Tension
Tilt Lock

Seat Depth: 19¼ Arm Width: 17½-20
Seat Width: 19 Cube: 7.6
Back Width: 18¼ Weight Rating: 300 lbs.
Back Height: 22¾

1 \$436
2 \$448
3 \$460

NOTES: Please reference pages 265-266 for additional specifications and mechanism information.

HSLVTMUKD

MID-BACK TASK

DIMENSIONS

FABRIC PRICE CODES

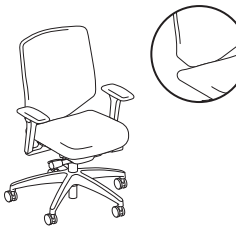

Upholstered Back
Pneumatic
Swivel
Synchro-tilt
Tilt Tension
Tilt Lock

Seat Depth: 19¼ Arm Width: 17½-20
Seat Width: 19 Cube: 7.6
Back Width: 18¼ Weight Rating: 300 lbs.
Back Height: 22¾

1 \$451
2 \$463
3 \$475

NOTES: Please reference pages 265-266 for additional specifications and mechanism information.

HON Recommendation: HSLVTMMKD.Y1.A.H.IM.CU__BL.SB.T - List Price \$531

HOW TO SPECIFY

| Select Model Number | Select Control Type | Select Arm Type | Select Caster | Select Mesh Back | Select Back Color | Select Back Fabric | Select Seat Fabric | Select Lumbar | Select Base | Select Frame |
|---------------------|--|--|----------------------|--|---|---|--------------------|---|-------------------------|----------------|
| | Y1 Synchro-Tilt w/ Seat Slider (+ \$20) | A Height and Width Adjustable Arms (+ \$75) | H Hard Caster | ilira®-stretch options IM Black Specify for model HSLVTMMKD only | OS Charcoal TI Titanium Specify for models HSLVTMRKD and HSLVTMUKD only | COMF46 Bittersweet COMF10 Ink COMF82 Meadow COMF90 Midnight COMF22 Putty COMF19 Sterling Specify for model HSLVTMUKD only | See page 266 | NL No Lumbar BL Black Adjustable Lumbar (+ \$30) | SB Standard Base | T Black |
| HSLVTMMKD | Y1 | A | H | IM | | | CU10 | BL | SB | T |
| HSLVTMRKD | Y1 | A | H | | OS | | CU10 | BL | SB | T |
| HSLVTMUKD | Y1 | A | H | | OS | COMF46 | CU10 | BL | SB | T |



Icon Legend on page 17

SOLVE[®] in Designer White

HSLVTMMS

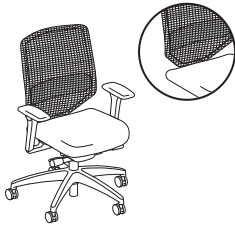

MID-BACK TASK

ilira[®]-stretch Back

Pneumatic
Swivel
Synchro-tilt
Tilt Tension
Tilt Lock

DIMENSIONS

Seat Depth: 19¼ Arm Width: 17½-20
Seat Width: 19 Cube: 7.6
Back Width: 18¼ Weight Rating: 300 lbs.
Back Height: 22½

FABRIC PRICE CODES

| | | | |
|---|-------|----|-------|
| 1 | \$446 | 8 | \$515 |
| 2 | \$458 | 9 | \$524 |
| 3 | \$470 | 10 | \$533 |
| 4 | \$479 | 11 | \$542 |
| 5 | \$488 | 12 | \$551 |
| 6 | \$497 | L | \$546 |
| 7 | \$506 | | |

NOTES: Please reference pages 265-266 for additional specifications and mechanism information.

HSLVSMMS



STOOL

ilira[®]-stretch Back

Pneumatic
Swivel
Synchro-tilt
Tilt Tension
Tilt Lock

DIMENSIONS

Seat Depth: 19¼ Arm Width: 17½-20
Seat Width: 19 Cube: 7.6
Back Width: 18¼ Weight Rating: 300 lbs.
Back Height: 22½

FABRIC PRICE CODES

| | | | |
|---|-------|----|-------|
| 1 | \$500 | 8 | \$569 |
| 2 | \$512 | 9 | \$578 |
| 3 | \$524 | 10 | \$587 |
| 4 | \$533 | 11 | \$596 |
| 5 | \$542 | 12 | \$605 |
| 6 | \$551 | L | \$600 |
| 7 | \$560 | | |

NOTES: Please reference pages 265-266 for additional specifications and mechanism information.

HON Recommendation: HSLVTMMS.Y1.ADW.H.IF.CU__DW.SB.DW - List Price \$606

HOW TO SPECIFY

| Select Model Number | Select Control Type | Select Arm Type | Select Caster/Glide | Select Mesh Back | Select Fabric | Select Lumbar | Select Base | Select Frame |
|---------------------|--|--|--|---|---------------|--|-------------------------|-----------------------------------|
| | Y0 Synchro-Tilt Y1 Synchro-Tilt w/ Seat Slider (+ \$20) Y2 Advanced Synchro-Tilt (+ \$65) <i>Y2 not available on stool</i> | N Armless ADW Height and Width Adjustable Arms (+ \$75) | H Hard Caster S Soft Caster (+ \$30) G Bell Glide (+ \$25) R Roll Control Caster (+ \$50) | ilira [®] -stretch options IM Black IF Fog IC Charcoal IH Chai IY Navy | See page 266 | NL No Lumbar BL Black Adjustable Lumbar (+ \$30) BY Bullseye Adjustable Lumbar (+ \$30) DW Designer White Adjustable Lumbar (+ \$30) KT Krypton Adjustable Lumbar (+ \$30) MR Ember Adjustable Lumbar (+ \$30) RE Regatta Adjustable Lumbar (+ \$30) TL Titanium Adjustable Lumbar (+ \$30) | SB Standard Base | DW Designer White (+ \$35) |
| H S L V T M M S | Y 1 | N | S | I M | C U 1 0 | B L | S B | D W |

SOLVE[®] in Designer White

OPEN MARKET



Icon Legend on page 17

HSLVTMRS

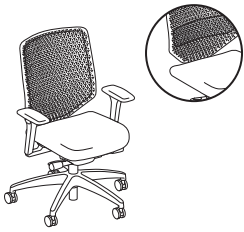

MID-BACK TASK

ReActiv[®] Back
Pneumatic
Swivel
Synchro-tilt
Tilt Tension
Tilt Lock

DIMENSIONS

Seat Depth: 19¼ Arm Width: 17½-20
Seat Width: 19 Cube: 7.6
Back Width: 18¾ Weight Rating: 300 lbs.
Back Height: 22¾

FABRIC PRICE CODES

| | | | |
|---|-------|----|-------|
| 1 | \$476 | 8 | \$545 |
| 2 | \$488 | 9 | \$554 |
| 3 | \$500 | 10 | \$563 |
| 4 | \$509 | 11 | \$572 |
| 5 | \$518 | 12 | \$581 |
| 6 | \$527 | L | \$576 |
| 7 | \$536 | | |

NOTES: Please reference pages 265-266 for additional specifications and mechanism information.

HSLVSMRS



STOOL

ReActiv[®] Back
Pneumatic
Swivel
Synchro-tilt
Tilt Tension
Tilt Lock

DIMENSIONS

Seat Depth: 19¼ Arm Width: 17½-20
Seat Width: 19 Cube: 7.6
Back Width: 18¾ Weight Rating: 300 lbs.
Back Height: 22¾

FABRIC PRICE CODES

| | | | |
|---|-------|----|-------|
| 1 | \$530 | 8 | \$599 |
| 2 | \$542 | 9 | \$608 |
| 3 | \$554 | 10 | \$617 |
| 4 | \$563 | 11 | \$626 |
| 5 | \$572 | 12 | \$635 |
| 6 | \$581 | L | \$630 |
| 7 | \$590 | | |

NOTES: Please reference pages 265-266 for additional specifications and mechanism information.

HON Recommendation: HSLVTMRS.Y1.ADW.H.DW.CU__NL.SB.DW - List Price \$606

HOW TO SPECIFY

| Select Model Number | Select Control Type | Select Arm Type | Select Caster/Glide | Select Back Color | Select Fabric | Select Lumbar | Select Base | Select Frame |
|---------------------|--|--|--|--|---------------|--|-------------------------|-----------------------------------|
| | Y0 Synchro-Tilt Y1 Synchro-Tilt w/ Seat Slider (+ \$20) Y2 Advanced Synchro-Tilt (+ \$65) <i>Y2 not available on stool</i> | N Armless ADW Height and Width Adjustable Arms (+ \$75) | H Hard Caster S Soft Caster (+ \$30) G Bell Glide (+ \$25) R Roll Control Caster (+ \$50) | OS Charcoal TI Titanium DW Designer White | See page 266 | NL No Lumbar BL Black Adjustable Lumbar (+ \$30) BY Bullseye Adjustable Lumbar (+ \$30) DW Designer White Adjustable Lumbar (+ \$30) KT Krypton Adjustable Lumbar (+ \$30) MR Ember Adjustable Lumbar (+ \$30) RE Regatta Adjustable Lumbar (+ \$30) TL Titanium Adjustable Lumbar (+ \$30) | SB Standard Base | DW Designer White (+ \$35) |
| H S L V T M R . | Y 1 . | A D W . | H . | O S . | C U 1 0 . | N L . | S B . | D W |



Icon Legend on page 17

SOLVE[®] in Designer White

HSLVTMUS

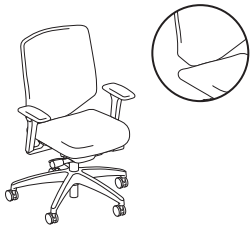

MID-BACK TASK

Upholstered Back

- Pneumatic
- Swivel
- Synchro-tilt
- Tilt Tension
- Tilt Lock

DIMENSIONS

- Seat Depth: 19¼
- Seat Width: 19
- Back Width: 18¼
- Back Height: 22½
- Arm Width: 17½-20
- Cube: 7.6
- Weight Rating: 300 lbs.

FABRIC PRICE CODES

- | | | | |
|---|-------|----|-------|
| 1 | \$491 | 8 | \$560 |
| 2 | \$503 | 9 | \$569 |
| 3 | \$515 | 10 | \$578 |
| 4 | \$524 | 11 | \$587 |
| 5 | \$533 | 12 | \$596 |
| 6 | \$542 | L | \$591 |
| 7 | \$551 | | |

NOTES: Please reference pages 265-266 for additional specifications and mechanism information.

HSLVSMUS



STOOL

Upholstered Back

- Pneumatic
- Swivel
- Synchro-tilt
- Tilt Tension
- Tilt Lock

DIMENSIONS

- Seat Depth: 19¼
- Seat Width: 19
- Back Width: 18¼
- Back Height: 22½
- Arm Width: 17½-20
- Cube: 7.6
- Weight Rating: 300 lbs.

FABRIC PRICE CODES

- | | | | |
|---|-------|----|-------|
| 1 | \$545 | 8 | \$614 |
| 2 | \$557 | 9 | \$623 |
| 3 | \$569 | 10 | \$632 |
| 4 | \$578 | 11 | \$641 |
| 5 | \$587 | 12 | \$650 |
| 6 | \$596 | L | \$645 |
| 7 | \$605 | | |

NOTES: Please reference pages 265-266 for additional specifications and mechanism information.

HON Recommendation: HSLVTMUS.Y1.ADW.H.DW.COMF___.COMP___.NL.SB.DW - List Price \$621

HOW TO SPECIFY

| Select Model Number | Select Control Type | Select Arm Type | Select Caster/Glide | Select Back Color | Select Back Fabric | Select Seat Fabric | Select Lumbar | Select Base | Select Frame |
|---------------------|--|--|--|--|---|--------------------|--|-------------------------|-----------------------------------|
| | Y0 Synchro-Tilt Y1 Synchro-Tilt w/ Seat Slider (+ \$20) Y2 Advanced Synchro-Tilt (+ \$65) <i>Y2 not available on stool</i> | N Armless ADW Height and Width Adjustable Arms (+ \$75) | H Hard Caster S Soft Caster (+ \$30) G Bell Glide (+ \$25) R Roll Control Caster (+ \$50) | OS Charcoal TI Titanium DW Designer White | COMF46 Bittersweet COMF10 Ink COMF82 Meadow COMF90 Midnight COMF22 Putty COMF19 Sterling | See page 266 | NL No Lumbar BL Black Adjustable Lumbar (+ \$30) BY Bullseye Adjustable Lumbar (+ \$30) DW Designer White Adjustable Lumbar (+ \$30) KT Krypton Adjustable Lumbar (+ \$30) MR Ember Adjustable Lumbar (+ \$30) RE Regatta Adjustable Lumbar (+ \$30) TL Titanium Adjustable Lumbar (+ \$30) | SB Standard Base | DW Designer White (+ \$35) |
| HSLVTMUS | .Y1 | .ADW | .H | .OS | .COMF10 | .COMP10 | .NL | .SB | .DW |



HSLVLMBR

LUMBAR PACK

DIMENSIONS

LIST PRICE

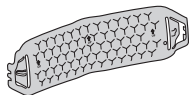

Ship Weight: 1 **Ⓢ**
Cube: 0.2

\$30

HOW TO SPECIFY

Select Model Number

Select Color

- BY** Bullseye Adjustable Lumbar
- DW** Designer White Adjustable Lumbar
- KT** Krypton Adjustable Lumbar
- MR** Ember Adjustable Lumbar
- RE** Regatta Adjustable Lumbar
- T** Black
- TI** Titanium

H S L V L M B R . T

HSLVFAP

FIXED ARM PACK

DIMENSIONS

LIST PRICE



Ship Weight: 6 **Ⓢ**
Cube: 1.0

\$107

HSLV2DAP

ADJUSTABLE ARM PACK

DIMENSIONS

LIST PRICE



Height and Width

Adjustable Arms Width: 17½-20
Height from Seat: 7¼-11¼
Ship Weight: 6 **Ⓢ**
Cube: 1.0

\$117

HSLV4DAP

ALL-ADJUSTABLE ARM PACK

DIMENSIONS

LIST PRICE



Including Pivot

Ship Weight: 6 **Ⓢ**
Cube: 1.0

\$158

HOW TO SPECIFY

Select Model Number

Select Color

- T** Black
- TI** Titanium
- DW** Designer White (available on HSLV2DAP only)

H S L V 2 D A P . T

SOOTHE®



Soothe Guest
Chairs and Tables.

SOOTHE®

Soothe offers the comfort and versatility to support a variety of healthcare and waiting environments. This family of patient and guest seats are constructed from durable materials and thoughtfully designed to be easily cleaned. The entire collection maximizes comfort along the patient's journey to recovery, enhances functionality for the caregiver, and creates the versatility required to deliver a higher level of care. Soothe simply helps create happier patients and better caregivers.



FEATURES

- Select Charcoal Urethane or solid hardwood arms in one of eight finishes.
- Wipeout space at the back of the seat allows for easy maintenance.
- Model HHCP1 has a responsive design back that moves with the patient for added comfort.
- Bench seating is available in two-seat or three-seat options.
- Choose Textured Charcoal or Textured Satin Chrome frame.
- Dual fabric option offers endless color combinations.
- Chairs can be ganged together to create straight rows.
- Warranted for users up to 350 lbs. (Model HHCG50 bariatric chair warranted for 500 lbs.)

SOOTHE[®] Options

MODEL OPTIONS

HHCG11
HHCG11DF - Dual Fabric



Guest Chair

HHCG21
HHCG21DF - Dual Fabric

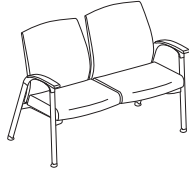

Two-Seat Chair

HHCG50
HHCG50DF - Dual Fabric

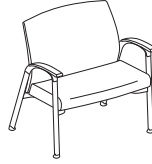

Bariatric Chair

HHCP1
HHCP1DF - Dual Fabric

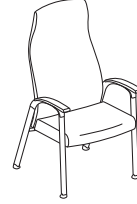

High-Back Patient Chair

HHCGB21

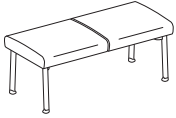

Two-Seat Bench

HHCGB31

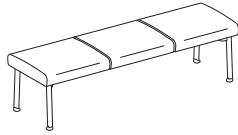

Three-Seat Bench

| FINISH | CODE | DESCRIPTION | PRICE | FRAME | CODE | DESCRIPTION | PRICE |
|--------|-------------|-------------------|---------------|-------|------------|-----------------------|-------------|
| | S | Charcoal Urethane | +\$0 | | P6N | Textured Satin Chrome | +\$0 |
| | H | Bourbon Cherry | +\$100 | | P7A | Textured Charcoal | +\$0 |
| | F | Shaker Cherry | +\$100 | | | | |
| | C | Harvest | +\$100 | | | | |
| | D | Natural Maple | +\$100 | | | | |
| | N | Mahogany | +\$100 | | | | |
| | MOCH | Mocha | +\$100 | | | | |
| | COGN | Cognac | +\$100 | | | | |
| | PINC | Pinnacle | +\$100 | | | | |

HON BRANDED FABRICS

GRADE 1

Attire
Centurion
Compass
Contourette Polyurethane
Dapper
Hamilton
Inertia
Optic

GRADE 2

Appoint Seating
Clyde
Dotty
Rush
Seed
Spin Seating
Whisper Vinyl

GRADE 3

In Season
Purl
Silvertex™ Vinyl

For a complete list of fabrics, including partnership fabrics, go to hon.com/fabricsandfinishes.

Reference Fabric Color Combinations on pages 20-24 for color codes and legend on page 21 for lead times. For Fire Code and Moisture Barrier model availability and ordering method, refer to pages 28-31. For additional HON to Supply COM fabric grade pricing, go to honready.hon.com and click on the HON to Supply COM link.

 For Fire Code model, availability and ordering method, refer to pages 28-31. Available on select models, contact HON Customer Support for availability.

DUAL FABRIC COM YARDAGE

Due to fabric pattern nesting and potential reduction of fabric yield, some dual fabric models may require more total yardage than standard models.

| | SEAT | BACK |
|----------|--------|--------|
| HHCG11DF | 1.4 yd | 1.5 yd |
| HHCG21DF | 1.7 yd | 2.3 yd |
| HHCG50DF | 1.4 yd | 2.3 yd |
| HHCP1DF | 1.4 yd | 1.9 yd |

SOOTHE[®]

Table Finish Options

AVAILABLE FINISHES

Soothe[®] Tables are available in 11 laminate colors. Each laminate has a specific selection of edges available.

| LAMINATE TOP COLORS | EDGE BAND COLORS |
|------------------------|---|
| Brilliant White (WHIT) | Brilliant White (WHIT) |
| Charcoal (S) | Charcoal (S) |
| Silver Mesh (B9) | Loft (LOFT) |
| Bourbon Cherry (H) | Bourbon Cherry (H), Muslin (T), White (WHIT) |
| Mahogany (N) | Mahogany (N), Loft (LOFT), Shadow (SHDW) |
| Natural Maple (D) | Natural Maple (D), Muslin (T), White (WHIT), Loft (LOFT) |
| Shaker Cherry (F) | Shaker Cherry (F), Muslin (T), White (WHIT), Loft (LOFT), Shadow (SHDW) |
| Harvest (C) | Harvest (C), Muslin (T), White (WHIT), Loft (LOFT) |
| Cognac (COGN) | Cognac (COGN), Muslin (T), White (WHIT) |
| Mocha (MOCH) | Mocha (MOCH), Muslin (T), White (WHIT), Loft (LOFT), Shadow (SHDW) |
| Pinnacle (PINC) | Pinnacle (PINC), Muslin (T), White (WHIT), Loft (LOFT), Shadow (SHDW) |



Icon Legend on page 17

HHCG11

GUEST CHAIR



DIMENSIONS

| | | | |
|--------------|-----|-----------------------|----------|
| Depth: | 27 | Arm Width: | 20½ |
| Width: | 25½ | Seat to Floor Height: | 18⅝ |
| Height: | 35 | Usable Seat Depth: | 18 |
| Seat Depth: | 18 | Ship Weight: | 55 |
| Seat Width: | 21½ | Cube: | 14.9 |
| Back Width: | 21 | COM: | 2.0 |
| Back Height: | 20½ | Weight Rating: | 350 lbs. |

FABRIC PRICE CODES

| | | | |
|---|--------|----|--------|
| 1 | \$961 | 8 | \$1237 |
| 2 | \$961 | 9 | \$1273 |
| 3 | \$1057 | 10 | \$1309 |
| 4 | \$1093 | 11 | \$1345 |
| 5 | \$1129 | 12 | \$1381 |
| 6 | \$1165 | L | — |
| 7 | \$1201 | | |

HHCG21

TWO-SEAT CHAIR

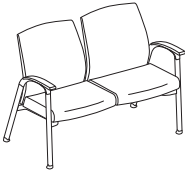

Outside Arms

DIMENSIONS

| | | | |
|-------------------|-----|-----------------------|----------|
| Depth: | 27 | Arm Width: | 42¾ |
| Width: | 48 | Seat to Floor Height: | 18⅝ |
| Height: | 35 | Usable Seat Depth: | 18 |
| Each Seat Depth: | 18 | Ship Weight: | 109 |
| Each Seat Width: | 21½ | Cube: | 33.8 |
| Each Back Width: | 21 | COM: | 3.4 |
| Each Back Height: | 20¼ | Weight Rating: | 350 lbs. |

FABRIC PRICE CODES

| | | | |
|---|--------|----|--------|
| 1 | \$1590 | 8 | \$2073 |
| 2 | \$1674 | 9 | \$2136 |
| 3 | \$1758 | 10 | \$2199 |
| 4 | \$1821 | 11 | \$2262 |
| 5 | \$1884 | 12 | \$2325 |
| 6 | \$1947 | L | — |
| 7 | \$2010 | | |

HHCG50

BARIATRIC CHAIR



DIMENSIONS

| | | | |
|--------------|-----|-----------------------|----------|
| Depth: | 26 | Arm Width: | 29½ |
| Width: | 34½ | Seat to Floor Height: | 18⅝ |
| Height: | 35 | Usable Seat Depth: | 18 |
| Seat Depth: | 18 | Ship Weight: | 80 |
| Seat Width: | 30½ | Cube: | 25.1 |
| Back Width: | 30 | COM: | 3.0 |
| Back Height: | 20½ | Weight Rating: | 750 lbs. |

FABRIC PRICE CODES

| | | | |
|---|--------|----|--------|
| 1 | \$1207 | 8 | \$1690 |
| 2 | \$1291 | 9 | \$1753 |
| 3 | \$1375 | 10 | \$1816 |
| 4 | \$1438 | 11 | \$1879 |
| 5 | \$1501 | 12 | \$1942 |
| 6 | \$1564 | L | — |
| 7 | \$1627 | | |

ⓘ HHCG50 is a Single Seat Bariatric chair warranted to 750 lbs.

HHCP1

HIGH-BACK PATIENT CHAIR



DIMENSIONS

| | | | |
|--------------|-----|-----------------------|----------|
| Depth: | 27 | Arm Width: | 20½ |
| Width: | 25½ | Seat to Floor Height: | 18⅝ |
| Height: | 46½ | Usable Seat Depth: | 18 |
| Seat Depth: | 18 | Ship Weight: | 61 |
| Seat Width: | 21½ | Cube: | 19.1 |
| Back Width: | 21 | COM: | 2.4 |
| Back Height: | 32 | Weight Rating: | 350 lbs. |

FABRIC PRICE CODES

| | | | |
|---|--------|----|--------|
| 1 | \$1070 | 8 | \$1553 |
| 2 | \$1154 | 9 | \$1616 |
| 3 | \$1238 | 10 | \$1679 |
| 4 | \$1301 | 11 | \$1742 |
| 5 | \$1364 | 12 | \$1805 |
| 6 | \$1427 | L | — |
| 7 | \$1490 | | |

OPEN MARKET

HOW TO SPECIFY

| | | | |
|---|--|---|---|
| <p>Select Model Number</p> <p>HHCG11</p> | <p>Select Finish</p> <p>S Charcoal Urethane H Bourbon Cherry (+ \$100) F Shaker Cherry (+ \$100) C Harvest (+ \$100) D Natural Maple (+ \$100) N Mahogany (+ \$100) MOCH Mocha (+ \$100) COGN Cognac (+ \$100) PINC Pinnacle (+ \$100)</p> <p>S</p> | <p>Select Fabric</p> <p>See page 277</p> <p>A190</p> | <p>Select Frame</p> <p>P6N Textured Satin Chrome P7A Textured Charcoal</p> <p>P6N</p> |
|---|--|---|---|

SOOTHE[®] Dual Fabric

GSA SIN 711-17



Icon Legend on page 17

HHCG11DF



GUEST CHAIR

Dual Fabric

DIMENSIONS

| | | | |
|--------------|-----|-----------------------|--------------|
| Depth: | 27 | Arm Width: | 20½ |
| Width: | 25½ | Seat to Floor Height: | 18⅞ |
| Height: | 35 | Usable Seat Depth: | 18 |
| Seat Depth: | 18 | Ship Weight: | 55 |
| Seat Width: | 21½ | Cube: | 14.9 |
| Back Width: | 21 | COM: | See page 277 |
| Back Height: | 20¼ | Weight Rating: | 350 lbs. |

FABRIC PRICE CODES

| | | |
|--------------------------------|---------------|--------------|
| 1 | \$1036 | |
| <i>Add to Base Price Above</i> | | |
| | Back | Seat |
| 2 | \$24 | \$24 |
| 3 | \$48 | \$48 |
| 4 | \$66 | \$66 |
| 5 | \$84 | \$84 |
| 6 | \$102 | \$102 |
| 7 | \$120 | \$120 |
| 8 | \$138 | \$138 |
| 9 | \$156 | \$156 |
| 10 | \$174 | \$174 |
| 11 | \$192 | \$192 |
| 12 | \$210 | \$210 |

NOTES: For dual fabric models, start with the base price, then add the additional amount for the back and seat from the corresponding matrix to determine final price. Choose any combination of fabric grades for back and seat. See examples below:
HHCG11DF base price (\$1036) + Grade 2 back fabric (add \$24) + Grade 4 seat fabric (add \$66) = Total \$1126 List

HHCG21DF

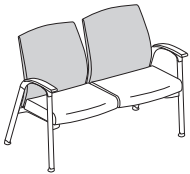

TWO-SEAT CHAIR

Dual Fabric
Outside Arms

DIMENSIONS

| | | | |
|-------------------|-----|-----------------------|--------------|
| Depth: | 27 | Arm Width: | 42¾ |
| Width: | 48 | Seat to Floor Height: | 18⅞ |
| Height: | 35 | Usable Seat Depth: | 18 |
| Each Seat Depth: | 18 | Ship Weight: | 109 |
| Each Seat Width: | 21½ | Cube: | 33.8 |
| Each Back Width: | 21 | COM: | See page 277 |
| Each Back Height: | 20¼ | Weight Rating: | 350 lbs. |

FABRIC PRICE CODES

| | | |
|--------------------------------|---------------|--------------|
| 1 | \$1665 | |
| <i>Add to Base Price Above</i> | | |
| | Back | Seat |
| 2 | \$48 | \$36 |
| 3 | \$96 | \$72 |
| 4 | \$132 | \$99 |
| 5 | \$168 | \$126 |
| 6 | \$203 | \$154 |
| 7 | \$239 | \$181 |
| 8 | \$275 | \$208 |
| 9 | \$311 | \$235 |
| 10 | \$347 | \$262 |
| 11 | \$383 | \$289 |
| 12 | \$419 | \$316 |

NOTES: For dual fabric models, start with the base price, then add the additional amount for the back and seat from the corresponding matrix to determine final price. Choose any combination of fabric grades for back and seat. See examples below:
HHCG21DF base price (\$1665) + Grade 2 back fabric (add \$48) + Grade 4 seat fabric (add \$99) = Total \$1812 List

HOW TO SPECIFY

| | | | | |
|-----------------------------------|--|--|--|--|
| <p>Select Model Number</p> | <p>Select Finish</p> <p>S Charcoal Urethane H Bourbon Cherry (+ \$100) F Shaker Cherry (+ \$100) C Harvest (+ \$100) D Natural Maple (+ \$100) N Mahogany (+ \$100) MOCH Mocha (+ \$100) COGN Cognac (+ \$100) PINC Pinnacle (+ \$100)</p> | <p>Select Back Fabric</p> <p>See page 277</p> | <p>Select Seat Fabric</p> <p>See page 277</p> | <p>Select Frame</p> <p>P6N Textured Satin Chrome P7A Textured Charcoal</p> |
| <p>H H C G 1 1 D F .</p> | <p>S .</p> | <p>A 1 9 0 .</p> | <p>R S 1 4 .</p> | <p>P 6 N</p> |



SOOTHE® Dual Fabric

HHCG50DF



SIN 711-17

BARIATRIC CHAIR

Dual Fabric

DIMENSIONS

| | | | |
|--------------|-----|-----------------------|--------------|
| Depth: | 26 | Arm Width: | 29½ |
| Width: | 34½ | Seat to Floor Height: | 18⅝ |
| Height: | 35 | Usable Seat Depth: | 18 |
| Seat Depth: | 18 | Ship Weight: | 80 |
| Seat Width: | 30½ | Cube: | 25.1 |
| Back Width: | 30 | COM: | See page 277 |
| Back Height: | 20½ | Weight Rating: | 750 lbs. |

FABRIC PRICE CODES

| | | |
|--------------------------------|---------------|--------------|
| 1 | \$1282 | |
| <i>Add to Base Price Above</i> | | |
| | Back | Seat |
| 2 | \$48 | \$36 |
| 3 | \$96 | \$72 |
| 4 | \$132 | \$99 |
| 5 | \$168 | \$126 |
| 6 | \$203 | \$154 |
| 7 | \$239 | \$181 |
| 8 | \$275 | \$208 |
| 9 | \$311 | \$235 |
| 10 | \$347 | \$262 |
| 11 | \$383 | \$289 |
| 12 | \$419 | \$316 |

NOTES: For dual fabric models, start with the base price, then add the additional amount for the back and seat from the corresponding matrix to determine final price. Choose any combination of fabric grades for back and seat. See examples below:

HHCG50DF base price (\$1282) + Grade 2 back fabric (add \$48) + Grade 4 seat fabric (add \$99) = Total \$1429 List

ⓘ HHCG50DF is a Single Seat Bariatric chair warranted to 750 lbs.

HHCP1DF

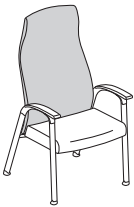

OPEN MARKET

HIGH-BACK PATIENT CHAIR

Dual Fabric

DIMENSIONS

| | | | |
|--------------|-----|-----------------------|--------------|
| Depth: | 27 | Arm Width: | 20½ |
| Width: | 25½ | Seat to Floor Height: | 18⅝ |
| Height: | 46½ | Usable Seat Depth: | 18 |
| Seat Depth: | 18 | Ship Weight: | 61 |
| Seat Width: | 21½ | Cube: | 19.1 |
| Back Width: | 21 | COM: | See page 277 |
| Back Height: | 32 | Weight Rating: | 350 lbs. |

FABRIC PRICE CODES

| | | |
|--------------------------------|---------------|--------------|
| 1 | \$1145 | |
| <i>Add to Base Price Above</i> | | |
| | Back | Seat |
| 2 | \$60 | \$24 |
| 3 | \$119 | \$49 |
| 4 | \$164 | \$67 |
| 5 | \$209 | \$85 |
| 6 | \$253 | \$104 |
| 7 | \$298 | \$122 |
| 8 | \$343 | \$140 |
| 9 | \$388 | \$158 |
| 10 | \$432 | \$177 |
| 11 | \$477 | \$195 |
| 12 | \$522 | \$213 |

NOTES: For dual fabric models, start with the base price, then add the additional amount for the back and seat from the corresponding matrix to determine final price. Choose any combination of fabric grades for back and seat. See examples below:

HHCP1DF base price (\$1145) + Grade 2 back fabric (add \$60) + Grade 4 seat fabric (add \$67) = Total \$1272 List

HOW TO SPECIFY

| | | | | |
|-----------------------------------|--|--|--|--|
| <p>Select Model Number</p> | <p>Select Finish</p> <p>S Charcoal Urethane H Bourbon Cherry (+ \$100) F Shaker Cherry (+ \$100) C Harvest (+ \$100) D Natural Maple (+ \$100) N Mahogany (+ \$100) MOCH Mocha (+ \$100) COGN Cognac (+ \$100) PINC Pinnacle (+ \$100)</p> | <p>Select Back Fabric</p> <p>See page 277</p> | <p>Select Seat Fabric</p> <p>See page 277</p> | <p>Select Frame</p> <p>P6N Textured Satin Chrome P7A Textured Charcoal</p> |
| <p>HHCG50DF</p> | <p>S</p> | <p>A190</p> | <p>RS14</p> | <p>P6N</p> |



HHCGB21

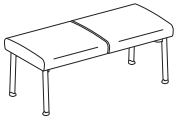

TWO-SEAT BENCH

DIMENSIONS

| | | | |
|-------------|-----|-----------------------|----------|
| Depth: | 20½ | Seat to Floor Height: | 17¾ |
| Width: | 44 | Usable Seat Depth: | 17¼ |
| Height: | 18¾ | Ship Weight: | 55 |
| Seat Width: | 22 | Cube: | 18.4 |
| | | COM: | 1.9 |
| | | Weight Rating: | 350 lbs. |

FABRIC PRICE CODES

| | | | |
|---|--------|----|--------|
| 1 | \$1152 | 8 | \$1359 |
| 2 | \$1188 | 9 | \$1386 |
| 3 | \$1224 | 10 | \$1413 |
| 4 | \$1251 | 11 | \$1440 |
| 5 | \$1278 | 12 | \$1467 |
| 6 | \$1305 | L | — |
| 7 | \$1332 | | |

! Benches cannot be ganged.

HHCGB31

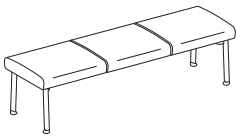

THREE-SEAT BENCH

DIMENSIONS

| | | | |
|-------------|-----|-----------------------|----------|
| Depth: | 20½ | Seat to Floor Height: | 17¾ |
| Width: | 66 | Usable Seat Depth: | 17¼ |
| Height: | 18¾ | Ship Weight: | 69 |
| Seat Width: | 22 | Cube: | 25.7 |
| | | COM: | 2.6 |
| | | Weight Rating: | 350 lbs. |

FABRIC PRICE CODES

| | | | |
|---|--------|----|--------|
| 1 | \$1482 | 8 | \$1689 |
| 2 | \$1518 | 9 | \$1716 |
| 3 | \$1554 | 10 | \$1743 |
| 4 | \$1581 | 11 | \$1770 |
| 5 | \$1608 | 12 | \$1797 |
| 6 | \$1635 | L | — |
| 7 | \$1662 | | |

! Benches cannot be ganged.

HOW TO SPECIFY

| | | |
|---|---|---|
| <p>Select Model Number</p> <p style="font-family: monospace; font-size: 1.2em; border: 1px solid black; padding: 2px;">H H C G B 2 1 .</p> | <p>Select Fabric</p> <p>See page 277</p> <p style="font-family: monospace; font-size: 1.2em; border: 1px solid black; padding: 2px;">R S 1 4 .</p> | <p>Select Frame</p> <p>P6N Textured Satin Chrome P7A Textured Charcoal</p> <p style="font-family: monospace; font-size: 1.2em; border: 1px solid black; padding: 2px;">P 6 N</p> |
|---|---|---|



HHCTS



IN-LINE TABLE TOP

DIMENSIONS

| | | | |
|---------|----|--------------|-----|
| Depth: | 22 | Ship Weight: | 8 |
| Width: | 16 | Cube: | 1.7 |
| Height: | 1½ | | |

LIST PRICE

\$324

NOTES: Can be ganged between two chairs or freestanding.

HHCTC



90-DEGREE RADIUS CORNER TABLE TOP

DIMENSIONS

| | | | |
|---------|----|--------------|-----|
| Depth: | 29 | Ship Weight: | 15 |
| Width: | 29 | Cube: | 2.4 |
| Height: | 1½ | | |

LIST PRICE

\$405

! Freestanding only.

HHCTRT



RECTANGLE TABLE TOP

DIMENSIONS

| | | | |
|---------|----|--------------|-----|
| Depth: | 22 | Ship Weight: | 20 |
| Width: | 40 | Cube: | 2.7 |
| Height: | 1½ | | |

LIST PRICE

\$540

! Freestanding only.

HHCTL4

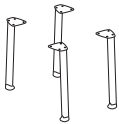

TABLE LEGS

Set of 4

DIMENSIONS

| | |
|--------------|-----|
| Ship Weight: | 8 |
| Cube: | 0.4 |

LIST PRICE

\$217

NOTES: Can be attached to any of the table tops above to create a freestanding table.

HOW TO SPECIFY

| | |
|---|--|
| <p>Select Model Number</p> <p>HHCTS .</p> | <p>Select Laminate and Edge</p> <p>See page 278</p> <p>DWHIT</p> |
|---|--|

HOW TO SPECIFY

| | |
|--|---|
| <p>Select Model Number</p> <p>HHCTL4 .</p> | <p>Select Paint Color</p> <p>P6N Textured Satin Chrome P7A Textured Charcoal</p> <p>P6N</p> |
|--|---|



HHCGBRCH

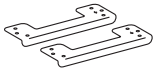

GANGING BRACKET

DIMENSIONS

Ship Weight: 2
Cube: 0.2

LIST PRICE

\$71

NOTES: For chair to chair connection. Does not connect a bench to other type of seating. Ganging brackets can be used with the seating models on pages 279-281. Bench models do not gang. Brackets are Charcoal only.

HHCGBR

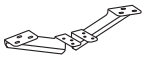

GANGING BRACKET

DIMENSIONS

Ship Weight: 5
Cube: 0.2

LIST PRICE

\$99

NOTES: For chair to table connection. Ganging brackets can be used with the seating models on pages 279-281. Bench models do not gang. Brackets are Charcoal only.

HOW TO SPECIFY

Select
Model Number

H H C G B R C H



HVL951



LOW-BACK

360° Motion
Pneumatic
Swivel
Tilt

Functions: **A, E, F, K, L**
(Function Key on pages 18-19)

DIMENSIONS

| | | | |
|-------------|--------------------------------|-----------------------|--|
| Depth: | 25 ⁵ / ₈ | Seat to Floor Height: | 17 ⁷ / ₈ -21 ¹ / ₂ |
| Width: | 26 ¹ / ₄ | Usable Seat Depth: | 18 ¹ / ₈ |
| Height: | 39 ³ / ₄ | Ship Weight: | 36 Ⓢ |
| Seat Depth: | 18 ⁷ / ₈ | Cube: | 5.3 |
| Seat Width: | 19 ¹ / ₈ | Weight Rating: | 250 lbs. |
| Back Width: | 18 ¹ / ₄ | | |

PRICE CODE

Fabric **\$435**

NOTES: Model HVL951 is a mesh-back task chair with an active pivoting 5-star base. Armless. Chrome base cap. Black frame. **HON 5-Year Limited Warranty.**

HON Recommendation: HVL951.ES10.T - List Price \$435

HOW TO SPECIFY

| | | |
|---|---|---|
| <p>Select Model Number</p> <p>H V L 9 5 1</p> | <p>Select Fabric</p> <p>ES10 Black</p> <p>E S 1 0</p> | <p>Select Frame</p> <p>T Black</p> <p>T</p> |
|---|---|---|

TOPFLIGHT™ Wood Seating

OPEN MARKET



Icon Legend on page 17

HVL844



HIGH-BACK

Pneumatic
Swivel
Tilt
Tilt Tension
Tilt Lock
Fixed Padded Wood Arms and Base

Functions: **A, E, F, K, L**
(Function Key on pages 18-19)

NOTES: Wood accents available in Bourbon Cherry and Mahogany. High-back design. SofThread™ Leather. Tailored padded back design provides strong lumbar support. Fixed padded loop arms. Use with coordinated Guest Chair models HVL852 and HVL853 shown below.

HON 5-Year Limited Warranty.

HON Recommendation: HVL844.H.SB11 - List Price \$532

DIMENSIONS

| | | | |
|--------------|---------------------------------|-----------------------|--|
| Depth: | 30 | Arm Width: | 20¼ |
| Width: | 28 | Seat to Floor Height: | 17 ³ / ₁₆ -21 ¹ / ₁₆ |
| Height: | 47 ⁵ / ₁₆ | Usable Seat Depth: | 17½ |
| Seat Depth: | 18½ | Ship Weight: | 58 Ⓢ |
| Seat Width: | 20½ | Cube: | 6.4 |
| Back Width: | 20½ | Weight Rating: | 250 lbs. |
| Back Height: | 27½ | | |

PRICE CODE

Leather \$532

HVL852



GUEST CHAIR

Leg Base
Arms
Upholstered Back
Wood Frame

NOTES: Wood frames available in Bourbon Cherry and Mahogany. Black SofThread™ Leather inset in back and on seat. Black SofThread™ Leather. Easier assembly - seat now attached to frame. Use with coordinating Executive model HVL844 shown above. **HON 5-Year Limited Warranty.**

HON Recommendation: HVL852.H.SB11 - List Price \$333

DIMENSIONS

| | | | |
|--------------|-----|-----------------------|----------|
| Depth: | 22 | Arm Width: | 20 |
| Width: | 22½ | Seat to Floor Height: | 18½ |
| Height: | 31 | Usable Seat Depth: | 17 |
| Seat Depth: | 17 | Ship Weight: | 26 Ⓢ |
| Seat Width: | 20 | Cube: | 3.4 |
| Back Width: | 20 | Weight Rating: | 250 lbs. |
| Back Height: | 13 | | |

PRICE CODE

Leather \$333

HVL853

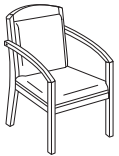

GUEST CHAIR

Leg Base
Arms
Upholstered Back
Wood Frame

NOTES: Wood frames available in Bourbon Cherry and Mahogany. Black SofThread™ Leather on fully-upholstered back panel and on seat. High-back design. Use with coordinating Executive model HVL844 shown above. **HON 5-Year Limited Warranty.**

HON Recommendation: HVL853.H.SB11 - List Price \$403

DIMENSIONS

| | | | |
|--------------|-----|-----------------------|----------|
| Depth: | 23¾ | Arm Width: | 20¼ |
| Width: | 23¾ | Seat to Floor Height: | 19½ |
| Height: | 36¾ | Usable Seat Depth: | 18¼ |
| Seat Depth: | 18¼ | Ship Weight: | 35 Ⓢ |
| Seat Width: | 22 | Cube: | 6.9 |
| Back Width: | 18½ | Weight Rating: | 250 lbs. |
| Back Height: | 15¼ | | |

PRICE CODE

Leather \$403

HOW TO SPECIFY

| | | |
|--|--|---|
| <p>Select Model Number</p> <p>H V L 8 4 4</p> | <p>Select Wood Finish</p> <p>H Bourbon Cherry N Mahogany</p> <p>H</p> | <p>Select Fabric</p> <p>SB11 Black SofThread™ Leather</p> <p>S B 1 1</p> |
|--|--|---|



TORCH™ Mesh Chairs

HVL511



MID-BACK

Pneumatic
Swivel
Tilt
Tilt Tension
Tilt Lock
Fixed Arms

Functions: **A, E, F, K, L**
(Function Key on pages 18-19)

DIMENSIONS

| | | | |
|--------------|-----|-----------------------|-------------|
| Depth: | 26 | Arm Width: | 18¾ |
| Width: | 26 | Seat to Floor Height: | 16⅝-20⅝ |
| Height: | 40½ | Usable Seat Depth: | 18¾ |
| Seat Depth: | 18¾ | Ship Weight: | 30 Ⓢ |
| Seat Width: | 19½ | Cube: | 3.8 |
| Back Width: | 17¾ | Weight Rating: | 250 lbs. |
| Back Height: | 21¾ | | |

PRICE CODE

Fabric **\$218**

NOTES: Mid-back Mesh chair. Comfortable and breathable mesh back. Black fabric seat. Black frame. Fixed arms. **HON 5-Year Limited Warranty.**

HON Recommendation: HVL511.LH10 - List Price \$218

HVL515

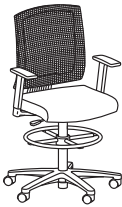

TASK STOOL

Pneumatic
Swivel
Fixed Arms

Functions: **A, E**
(Function Key on pages 18-19)

DIMENSIONS

| | | | |
|--------------|-----|-----------------------|-------------|
| Depth: | 26 | Arm Width: | 18¾ |
| Width: | 26 | Seat to Floor Height: | 23⅝-33 |
| Height: | 52 | Usable Seat Depth: | 18¾ |
| Seat Depth: | 18¾ | Ship Weight: | 38 Ⓢ |
| Seat Width: | 19½ | Cube: | 4.6 |
| Back Width: | 17¾ | Weight Rating: | 250 lbs. |
| Back Height: | 21¾ | | |

PRICE CODE

Fabric **\$303**

NOTES: Comfortable and breathable mesh back. Black fabric seat. Fixed arms. **HON 5-Year Limited Warranty.**

HON Recommendation: HVL515.LH10 - List Price \$303

HOW TO SPECIFY

| | |
|----------------------------|----------------------|
| Select Model Number | Select Fabric |
| | LH10 Black Fabric |
| H V L 5 1 1 . | L H 1 0 |

TRACTION™ Executive Chairs

OPEN MARKET



Icon Legend on page 17

HVL103



HIGH-BACK

Pneumatic
Swivel
Tilt
Tilt Tension
Tilt Lock
Fixed Padded Arms
Functions: **A, E, F, K, L**
(Function Key on pages 18-19)

DIMENSIONS

| | | | |
|--------------|--------------------------------|-----------------------|------------------------------------|
| Depth: | 28 ³ / ₄ | Arm Width: | 18 ⁷ / ₈ |
| Width: | 26 ³ / ₄ | Seat to Floor Height: | 17 ¹ / ₄ -21 |
| Height: | 42 ¹ / ₂ | Usable Seat Depth: | 18 ³ / ₄ |
| Seat Depth: | 18 ¹ / ₄ | Ship Weight: | 36.0 Ⓢ |
| Seat Width: | 19 ¹ / ₂ | Cube: | 4.1 |
| Back Width: | 19 ¹ / ₂ | Weight Rating: | 250 lbs. |
| Back Height: | 24 ⁷ / ₈ | | |

PRICE CODE

Leather **\$349**

NOTES: Black SofThread™ Leather. Red SofThread™ and White SofThread™ Leather options. Polished base. Fixed, padded arms. **HON 5-Year Limited Warranty.**

HON Recommendation: HVL103.SB11 - List Price \$349

HVL102



HIGH-BACK MODERN GUEST CHAIR

Padded Arms
Cantilever Base

DIMENSIONS

| | | | |
|--------------|----------------------------------|-----------------------|----------------------------------|
| Depth: | 27 ¹¹ / ₆₄ | Arm Width: | 18 ⁴⁵ / ₆₄ |
| Width: | 20 ⁵ / ₆₄ | Seat to Floor Height: | 18 ²⁹ / ₃₂ |
| Height: | 39 ³ / ₈ | Usable Seat Depth: | 18 ⁷ / ₆₄ |
| Seat Depth: | 18 ⁷ / ₆₄ | Ship Weight: | 36.8 Ⓢ |
| Seat Width: | 19 ¹¹ / ₁₆ | Cube: | 4.4 |
| Back Width: | 18 ²⁹ / ₃₂ | Weight Rating: | 250 lbs. |
| Back Height: | 24 ³⁹ / ₆₄ | | |

PRICE CODE

Leather **\$248**

NOTES: Black SofThread™ Leather. Polished, cantilever base. Polished, padded arms. **HON 5-Year Limited Warranty.**

HON Recommendation: HVL102.SB11 - List Price \$248

HOW TO SPECIFY

Select Model Number

H V L 1 0 3 .

Select Fabric

- SB11** Black SofThread™ Leather
Specify for models HVL102 and HVL103 only
- SB06** White SofThread™ Leather
Specify for model HVL103 only
- SB42** Red SofThread™ Leather
Specify for model HVL103 only

S B 1 1



HVL604



HIGH-BACK

Pneumatic
Swivel
Tilt
Tilt Tension
Tilt Lock
Fixed Arms

Functions: **A, E, F, K, L, T**
(Function Key on pages 18-19)

DIMENSIONS

| | | | |
|--------------|-----|-----------------------|----------|
| Depth: | 26½ | Arm Width: | 20½ |
| Width: | 25 | Seat to Floor Height: | 16¼-20¾ |
| Height: | 46½ | Usable Seat Depth: | 18¼ |
| Seat Depth: | 18¼ | Ship Weight: | 40 Ⓢ |
| Seat Width: | 19¾ | Cube: | 4.1 |
| Back Width: | 20 | Weight Rating: | 250 lbs. |
| Back Height: | 26½ | | |

PRICE CODE

Fabric **\$202**
Leather **\$211**

NOTES: Available in Black Fabric ES10 and SofThread™ Leather SB11. High-back Executive Chair. Black frame. Fixed, tapered loop arms. Coordinating guest chair HVL605. **HON 5-Year Limited Warranty.**

HON Recommendation: HVL604.SB11 - List Price \$211

HVL605



GUEST CHAIR

Leg Base
Arms
Stacks up to Four High

DIMENSIONS

| | | | |
|--------------|-----|-----------------------|----------|
| Depth: | 24 | Arm Width: | 19½ |
| Width: | 23½ | Seat to Floor Height: | 18½ |
| Height: | 34½ | Usable Seat Depth: | 17½ |
| Seat Depth: | 17½ | Ship Weight: | 22.2 Ⓢ |
| Seat Width: | 18½ | Cube: | 3.0 |
| Back Width: | 18½ | Weight Rating: | 250 lbs. |
| Back Height: | 17¾ | | |

PRICE CODE

Leather **\$212**

NOTES: Validate™ HVL605 Guest Chair. Waterfall seat edge. Wall-saver design. Fixed arms. Stackable up to 4-high. Contemporary rectilinear steel frame in Matte Black. Use with coordinating Executive Chair model HVL604. **HON 5-Year Limited Warranty.**

HON Recommendation: HVL605.SB11 - List Price \$212

HVL685



HIGH-BACK

Pneumatic
Swivel
Tilt Tension
Tilt Lock
Fixed Padded Arms

Functions: **A, E, K, L**
(Function Key on pages 18-19)

DIMENSIONS

| | | | |
|-------------|-----|-----------------------|----------|
| Depth: | 32 | Back Height: | 28½ |
| Width: | 27½ | Seat to Floor Height: | 20-23 |
| Height: | 45 | Usable Seat Depth: | 20 |
| Seat Depth: | 20 | Ship Weight: | 67 Ⓢ |
| Seat Width: | 22¼ | Cube: | 9.5 |
| Back Width: | 21 | Weight Rating: | 450 lbs. |

PRICE CODE

Leather **\$702**

NOTES: Large scale model HVL685 will support up to 450 lbs with normal use. Available in SofThread™ Leather SB11. **HON 5-Year Limited Warranty.**

HON Recommendation: HVL685.SB11 - List Price \$702

HOW TO SPECIFY

| | |
|--|---|
| <p>Select Model Number</p> <p>H V L 6 0 4</p> | <p>Select Fabric</p> <p>SB11 Black SofThread™ Leather ES10 Black Fabric <i>Specify for model HVL604 only</i></p> <p>S B 1 1</p> |
|--|---|



VALUTASK®

HVL205



LOW-BACK

Pneumatic
Swivel
Tilt
Tilt Tension
Tilt Lock

DIMENSIONS

| | | | |
|-------------|-----|-----------------------|-------------|
| Depth: | 23 | Back Height: | 18 |
| Width: | 23 | Seat to Floor Height: | 15¼-19¼ |
| Height: | 39½ | Usable Seat Depth: | 18 |
| Seat Depth: | 18 | Ship Weight: | 29 Ⓢ |
| Seat Width: | 19 | Cube: | 3.2 |
| Back Width: | 18 | Weight Rating: | 250 lbs. |

PRICE CODE

Mesh **\$182**

NOTES: Comfortable and breathable mesh back. Black sandwich mesh seat. Black frame. **HON 5-Year Limited Warranty.**

HON Recommendation: HVL205.MM10.T - List Price \$182

HVL206



MID-BACK

Pneumatic
Swivel
Tilt
Tilt Tension
Tilt Lock

Functions: **A, E, F, K, L**
(Function Key on pages 18-19)

DIMENSIONS

| | | | |
|-------------|----|-----------------------|---------------|
| Depth: | 23 | Back Height: | 22 |
| Width: | 25 | Seat to Floor Height: | 18-22 |
| Height: | 38 | Usable Seat Depth: | 18 |
| Seat Depth: | 18 | Ship Weight: | 27.5 Ⓢ |
| Seat Width: | 18 | Cube: | 3.3 |
| Back Width: | 18 | Weight Rating: | 250 lbs. |

PRICE CODE

Mesh **\$182**

NOTES: Comfortable and breathable mesh back. Black sandwich mesh seat. Black frame. Can be paired with HVL995 arms. **HON 5-Year Limited Warranty.**

HON Recommendation: HVL206.MM10.T - List Price \$182

HVL210



TASK LOW-BACK

Pneumatic
Swivel
Tilt
Tilt Tension
Tilt Lock

Functions: **A, E, F, K, L**
(Function Key on pages 18-19)

DIMENSIONS

| | | | |
|-------------|-----|-----------------------|-------------|
| Depth: | 33½ | Back Height: | 20¼ |
| Width: | 24½ | Seat to Floor Height: | 17-20½ |
| Height: | 38¼ | Usable Seat Depth: | 17¾ |
| Seat Depth: | 17¾ | Ship Weight: | 31 Ⓢ |
| Seat Width: | 19¾ | Cube: | 3.6 |
| Back Width: | 19¾ | Weight Rating: | 250 lbs. |

PRICE CODE

Sandwich Mesh **\$182**

NOTES: Sturdy textured black frame. HVL995 optional arm pack available. **HON 5-Year Limited Warranty.**

HON Recommendation: HVL210.MM10 - List Price \$182

HVL215



TASK STOOL

Pneumatic
Swivel

Functions: **A, E**
(Function Key on pages 18-19)

DIMENSIONS

| | | | |
|-------------|-----|-----------------------|-------------|
| Depth: | 33½ | Back Height: | 19 |
| Width: | 24½ | Seat to Floor Height: | 24½-33½ |
| Height: | 51⅞ | Usable Seat Depth: | 17¾ |
| Seat Depth: | 17¾ | Ship Weight: | 37 Ⓢ |
| Seat Width: | 19¾ | Cube: | 5.7 |
| Back Width: | 19¾ | Weight Rating: | 250 lbs. |

PRICE CODE

Sandwich Mesh **\$253**

NOTES: Black sandwich mesh. Sturdy textured black frame. HVL995 optional arm pack available. **HON 5-Year Limited Warranty.**

HON Recommendation: HVL215.MM10 - List Price \$253

HVL995



HEIGHT-ADJUSTABLE ARMS

Functions: **Q**
(Function Key on pages 18-19)

DIMENSIONS

| | |
|------------------------|------------|
| Adjustable Arms Width: | 18¾ |
| Height from Seat: | 8-11 |
| Ship Weight: | 7 Ⓢ |
| Cube: | 0.6 |

LIST PRICE

\$71

NOTES: Arm color is black. Height-adjustable. Compatible with HVL205, HVL210, and HVL215. **HON 5-Year Limited Warranty.**

HON Recommendation: HVL995 - List Price \$71

HOW TO SPECIFY

| | | |
|--|--|---|
| <p>Select Model Number</p> <p>H V L 2 0 5 .</p> | <p>Select Fabric</p> <p>MM10 Black Sandwich Mesh Fabric</p> <p>M M 1 0 .</p> | <p>Select Frame</p> <p>T Black Specify frame color for models HVL205 and HVL206 only</p> <p>T</p> |
|--|--|---|

VERSANT® TANDEM



Versant Tandem Seating and Tables.

VERSANT® TANDEM

Everyone deserves a break from time to time, and a comfy seat in which to enjoy one. Bring stylish support to your welcome areas, public spaces and break rooms with Versant. With a combination of tandem seats, bariatric chairs and a high-back patient chair, it's ideal for both healthcare environments and offices. Arched arms support the upper body and padded seats put people at ease for longer periods of time. Versant brings versatility to every corner of your space.



FEATURES

- Hardwood side frames are integrated with a steel structural frame.
- Stylish arched arm offers greater upper body support.
- Seats are removable for easy cleaning and replacement.
- Contrasting covers are available as special order (please contact customer service).
- Solid hardwood in one of eight attractive finishes.
- Available in hundreds of quality HON fabrics.
- Warranted for users up to 350 lbs. (Model HHCB50 is warranted for users up to 500 lbs.)

VERSANT® Tandem Options

MODEL OPTIONS

HHB02

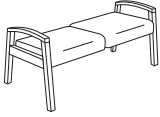

Two-Seat Bench

HHB03

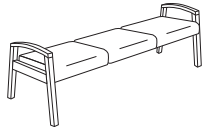

Three-Seat Bench

HHCT01

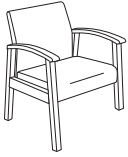

Single Seat

Leg Base, Arms

HHCT02

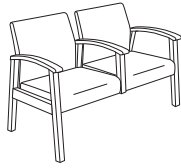

Two-Seat

Leg Base, Center Arm, Arms

HHCT12

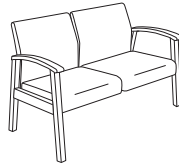

Two-Seat

Leg Base, Arms

HHCB50

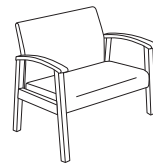

Bariatric Chair

Leg Base, Arms

AVAILABLE FINISHES

Versant® Tandem Seating is available in 8 wood finishes.

WOOD FINISHES

Bourbon Cherry (H)

Cognac (COGN)

Harvest (C)

Mahogany (N)

Mocha (MOCH)

Natural Maple (D)

Pinnacle (PINC)

Shaker Cherry (F)

HON BRANDED FABRICS

GRADE 1

Attire
Centurion
Compass
Contourette Polyurethane
Dapper
Hamilton
Inertia
Optic

GRADE 2

Appoint Seating
Clyde
Dotty
Rush
Seed
Spin Seating
Whisper Vinyl

GRADE 3

In Season
Purl
Silvertex™ Vinyl

GRADE L

Denver Leather

For a complete list of fabrics, including partnership fabrics, go to hon.com/fabricsandfinishes.

Reference Fabric Color Combinations on pages 20-24 for color codes and legend on page 21 for lead times. Contrasting covers on seat and back are available as special order. Please contact Customer Service. For additional HON to Supply COM fabric grade pricing, go to honready.hon.com and click on the HON to Supply COM link.

 For Fire Code model, availability and ordering method, refer to pages 28-31. Available on select models, contact HON Customer Support for availability.

AVAILABLE LAMINATES

Versant® Tandem Laminate Occasional Tables are available in 8 laminates.

LAMINATES

Bourbon Cherry (H)

Cognac (COGN)

Harvest (C)

Mahogany (N)

Mocha (MOCH)

Natural Maple (D)

Pinnacle (PINC)

Shaker Cherry (F)



VERSANT® TANDEM

HHB02



TWO-SEAT BENCH

DIMENSIONS

| | | | |
|------------------|--------------------------------|-----------------------|--------------------------------|
| Depth: | 20 ³ / ₈ | Seat to Floor Height: | 19 ¹ / ₂ |
| Width: | 45 ¹ / ₂ | Usable Seat Depth: | 19 ³ / ₄ |
| Height: | 23 | Ship Weight: | 62 |
| Each Seat Depth: | 20 ³ / ₈ | Cube: | 16.2 |
| Each Seat Width: | 21 ¹ / ₂ | COM: | 2.0 |
| Arm Width: | 42 ¹ / ₂ | Weight Rating: | 350 lbs. (per seat) |

FABRIC PRICE CODES

| | | | |
|---|--------|----|--------|
| 1 | \$1446 | 8 | \$1722 |
| 2 | \$1494 | 9 | \$1758 |
| 3 | \$1542 | 10 | \$1794 |
| 4 | \$1578 | 11 | \$1830 |
| 5 | \$1614 | 12 | \$1866 |
| 6 | \$1650 | L | \$1846 |
| 7 | \$1686 | | |

HHB03

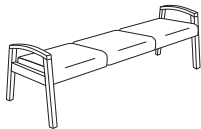

THREE-SEAT BENCH

DIMENSIONS

| | | | |
|------------------|--------------------------------|-----------------------|--------------------------------|
| Depth: | 20 ³ / ₈ | Seat to Floor Height: | 19 ¹ / ₂ |
| Width: | 66 ¹ / ₂ | Usable Seat Depth: | 19 ³ / ₄ |
| Height: | 23 | Ship Weight: | 80 |
| Each Seat Depth: | 20 ³ / ₈ | Cube: | 24.5 |
| Each Seat Width: | 21 ¹ / ₂ | COM: | 2.5 |
| Arm Width: | 63 ¹ / ₂ | Weight Rating: | 350 lbs. (per seat) |

FABRIC PRICE CODES

| | | | |
|---|--------|----|--------|
| 1 | \$1859 | 8 | \$2204 |
| 2 | \$1919 | 9 | \$2249 |
| 3 | \$1979 | 10 | \$2294 |
| 4 | \$2024 | 11 | \$2339 |
| 5 | \$2069 | 12 | \$2384 |
| 6 | \$2114 | L | \$2359 |
| 7 | \$2159 | | |

HON Recommendation: HHB02.MOCH.SX__ - List Price \$1542

HOW TO SPECIFY

| | | |
|--|---|--|
| <p>Select Model Number</p> <p>HHB02</p> | <p>Select Finish</p> <p>See page 293</p> <p>MOCH</p> | <p>Select Seat Fabric</p> <p>See page 293</p> <p>SX05</p> |
|--|---|--|

VERSANT® TANDEM

Laminate Occasional Tables

GSA SIN 711-11



HHCT048

COFFEE TABLE

DIMENSIONS

LIST PRICE

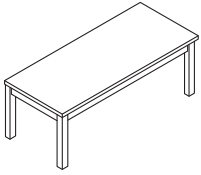

Length: 48
Width: 20
Height: 17

Ship Weight: 44 Ⓢ
Cube: 3.0

\$585

HHCT024

CORNER TABLE

DIMENSIONS

LIST PRICE

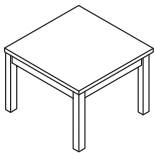

Length: 24
Width: 24
Height: 17

Ship Weight: 20 Ⓢ
Cube: 1.4

\$489

HHCT020

END TABLE

DIMENSIONS

LIST PRICE

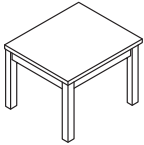

Length: 24
Width: 20
Height: 17

Ship Weight: 22 Ⓢ
Cube: 1.4

\$459

HON Recommendation: HHCT024.MOCH - List Price \$489

HOW TO SPECIFY

| | |
|----------------------------|--|
| <p>Select Model Number</p> | <p>Select Laminate</p> <p>See page 294</p> |
| <p>HHCT048</p> | <p>MOCH</p> |



Icon Legend on page 17

VERSANT® TANDEM

HHCT01

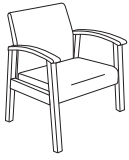

SINGLE SEAT

Leg Base
Arms

DIMENSIONS

| | | | |
|--------------|-----|-----------------------|----------|
| Depth: | 27 | Arm Width: | 20½ |
| Width: | 25 | Seat to Floor Height: | 18 |
| Height: | 34 | Usable Seat Depth: | 19¼ |
| Seat Depth: | 20¼ | Ship Weight: | 57 |
| Seat Width: | 21 | Cube: | 20.1 |
| Back Width: | 21 | COM: | 2.0 |
| Back Height: | 17 | Weight Rating: | 350 lbs. |

FABRIC PRICE CODES

| | | | |
|---|--------|----|--------|
| 1 | \$1102 | 8 | \$1378 |
| 2 | \$1150 | 9 | \$1414 |
| 3 | \$1198 | 10 | \$1450 |
| 4 | \$1234 | 11 | \$1486 |
| 5 | \$1270 | 12 | \$1522 |
| 6 | \$1306 | L | \$1502 |
| 7 | \$1342 | | |

HHCT02

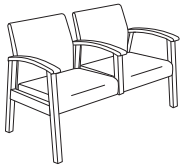

TWO-SEAT

Leg Base
Center Arm
Arms

DIMENSIONS

| | | | |
|-------------------|-----|-----------------------|------------|
| Depth: | 27 | Seat to Floor Height: | 18 |
| Width: | 47½ | Usable Seat Depth: | 19¼ |
| Height: | 34 | Ship Weight: | 87 |
| Each Seat Depth: | 20¼ | Cube: | 33.7 |
| Each Seat Width: | 21 | COM: | 3.5 |
| Each Back Width: | 21 | Weight Rating: | 350 lbs. |
| Each Back Height: | 17 | | (per seat) |

FABRIC PRICE CODES

| | | | |
|---|--------|----|--------|
| 1 | \$1926 | 8 | \$2409 |
| 2 | \$2010 | 9 | \$2472 |
| 3 | \$2094 | 10 | \$2535 |
| 4 | \$2157 | 11 | \$2598 |
| 5 | \$2220 | 12 | \$2661 |
| 6 | \$2283 | L | \$2626 |
| 7 | \$2346 | | |

HHCT12

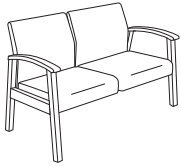

TWO-SEAT

Leg Base
Arms

DIMENSIONS

| | | | |
|-------------------|-----|-----------------------|------------|
| Depth: | 27 | Arm Width: | 41½ |
| Width: | 46 | Seat to Floor Height: | 18 |
| Height: | 34 | Usable Seat Depth: | 19¼ |
| Each Seat Depth: | 20¼ | Ship Weight: | 87 |
| Each Seat Width: | 21 | Cube: | 33.0 |
| Each Back Width: | 21 | COM: | 3.5 |
| Each Back Height: | 17 | Weight Rating: | 350 lbs. |
| | | | (per seat) |

FABRIC PRICE CODES

| | | | |
|---|--------|----|--------|
| 1 | \$1843 | 8 | \$2326 |
| 2 | \$1927 | 9 | \$2389 |
| 3 | \$2011 | 10 | \$2452 |
| 4 | \$2074 | 11 | \$2515 |
| 5 | \$2137 | 12 | \$2578 |
| 6 | \$2200 | L | \$2543 |
| 7 | \$2263 | | |

HHCB50

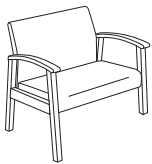

BARIATRIC SINGLE SEAT

Leg Base
Arms

DIMENSIONS

| | | | |
|-------------------|-----|-----------------------|----------|
| Depth: | 27 | Arm Width: | 29 |
| Width: | 33½ | Seat to Floor Height: | 18 |
| Height: | 34 | Usable Seat Depth: | 19¼ |
| Each Seat Depth: | 20¼ | Ship Weight: | 80 |
| Each Seat Width: | 30 | Cube: | 29.0 |
| Each Back Width: | 30 | COM: | 3.0 |
| Each Back Height: | 17 | Weight Rating: | 500 lbs. |

FABRIC PRICE CODES

| | | | |
|---|--------|----|--------|
| 1 | \$1651 | 8 | \$2065 |
| 2 | \$1723 | 9 | \$2119 |
| 3 | \$1795 | 10 | \$2173 |
| 4 | \$1849 | 11 | \$2227 |
| 5 | \$1903 | 12 | \$2281 |
| 6 | \$1957 | L | \$2251 |
| 7 | \$2011 | | |

HON Recommendation: HHCT01.MOCH.SX__ - List Price \$1198

HOW TO SPECIFY

Select
Model Number

HHCT01

Select
Finish

See page 293

MOCH

Select
Seat Fabric

See page 293

SX05

VOLT®



Volt Task Chairs and Stools shown with Voi® Desks.

VOLT®

Customizable comfort, distinctive styling and an affordable price point make Volt the family of task seating that supports your body and your budget. The stylish V-shaped back design can be specified in fabric, leather or breathable mesh, giving you more control over your look and feel. The personalized controls and generously proportioned seat and back deliver greater comfort, and are designed support to a wider variety of users. Volt delivers the look you desire, the comfort you demand, and the quality you expect. That's the power of practicality.



FEATURES

- Optional synchro-tilt control provides a smooth, natural recline.
- Optional height-adjustable arms provide a custom fit.
- Optional mesh back offers breathable support.
- Task stools feature an adjustable footring for additional lower body support.
- One-touch seat height adjustment easily moves the seat up and down.
- Tilt tension controls the rate and ease of recline.
- Tilt lock allows the user to lock out the tilt function.
- 360-degree swivel provides freedom of movement in any direction.
- Select models available in hundreds of quality HON fabrics.
- Warranted for users up to 275 lbs.

VOLT® 5700/5710 Series Options

MODEL OPTIONS

H5701



Task Chair

Pneumatic, Swivel, Tilt, Tilt Tension, Tilt Lock

H5703



Task Chair

Pneumatic, Swivel, Synchro-tilt, Tilt Tension, Tilt Lock

H5705



Task Stool

Pneumatic, Swivel, Adjustable Footring

H5711



Task Chair (Mesh Back)

Pneumatic, Swivel, Tilt, Tilt Tension, Tilt Lock

H5713



Task Chair (Mesh Back)

Pneumatic, Swivel, Synchro-tilt, Tilt Tension, Tilt Lock

H5715



Task Stool (Mesh Back)

Pneumatic, Swivel, Adjustable Footring

HON BRANDED FABRICS

GRADE 1

Black Fabric
Crimson Fabric
Navy Fabric

GRADE 2

GRADE 3

For a complete list of fabrics, including partnership fabrics, go to hon.com/fabricsandfinishes.

Reference Fabric Color Combinations on pages 20-24 for color codes and legend on page 21 for lead times.

⚠ For Fire Code model, availability and ordering method, refer to pages 28-31. Available on select models, contact HON Customer Support for availability.

VOLT® 5700 Series

OPEN MARKET



Icon Legend on page 17

H5701



TASK CHAIR

Pneumatic
Swivel
Tilt
Tilt Tension
Tilt Lock
Functions: **A, E, F, K, L**
(Function Key on pages 18-19)

DIMENSIONS

| | | | |
|--------------|--------------------------------|-----------------------|-----------------------------------|
| Depth: | 25 ³ / ₄ | Seat to Floor Height: | 18-22 ¹ / ₄ |
| Width: | 26 | Usable Seat Depth: | 18 ³ / ₄ |
| Height: | 40 | Ship Weight: | 29 Ⓢ |
| Seat Depth: | 18 ³ / ₄ | Cube: | 5.1 |
| Seat Width: | 18 ¹ / ₂ | Weight Rating: | 250 lbs. |
| Back Width: | 17 ¹ / ₄ | | |
| Back Height: | 18 ³ / ₄ | | |

FABRIC PRICE CODES

1 \$233 L \$263

H5703



TASK CHAIR

Pneumatic
Swivel
Synchro-tilt
Tilt Tension
Tilt Lock
Functions: **A, E, J, K, L**
(Function Key on pages 18-19)

DIMENSIONS

| | | | |
|--------------|--------------------------------|-----------------------|-----------------------------------|
| Depth: | 25 ³ / ₄ | Seat to Floor Height: | 18-22 ¹ / ₄ |
| Width: | 26 | Usable Seat Depth: | 18 ³ / ₄ |
| Height: | 40 | Ship Weight: | 29 Ⓢ |
| Seat Depth: | 18 ³ / ₄ | Cube: | 5.1 |
| Seat Width: | 18 ¹ / ₂ | Weight Rating: | 250 lbs. |
| Back Width: | 17 ¹ / ₄ | | |
| Back Height: | 18 ³ / ₄ | | |

FABRIC PRICE CODES

1 \$272 L \$302

H5705



TASK STOOL

Pneumatic
Swivel
Adjustable Footring
Functions: **A, E**
(Function Key on pages 18-19)

DIMENSIONS

| | | | |
|--------------|--------------------------------|-----------------------|--|
| Depth: | 29 ¹ / ₂ | Seat to Floor Height: | 22 ⁷ / ₈ -32 ³ / ₈ |
| Width: | 27 | Usable Seat Depth: | 18 |
| Height: | 49 ⁷ / ₈ | Ship Weight: | 36 Ⓢ |
| Seat Depth: | 20 | Cube: | 6.0 |
| Seat Width: | 19 | Weight Rating: | 250 lbs. |
| Back Width: | 16 ¹ / ₂ | | |
| Back Height: | 20 | | |

FABRIC PRICE CODES

1 \$384 L \$414

H5795

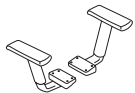

HEIGHT-ADJUSTABLE ARMS

Non-upholstered
Functions: **Q**
(Function Key on pages 18-19)

DIMENSIONS

| | |
|------------------------|---|
| Adjustable Arms Width: | 17 ³ / ₈ |
| Height from Seat: | 7 ⁵ / ₈ -10 ⁵ / ₈ |
| Ship Weight: | 5 Ⓢ |
| Cube: | 0.6 |

LIST PRICE

\$74

HON Recommendation: H5703.GA10.T with H5795 Arm Pack - List Price \$346

HOW TO SPECIFY

| | | |
|---|---|---|
| <p>Select Model Number</p> <p>H 5 7 0 3 .</p> | <p>Select Fabric</p> <p>SB11 Black Leather GA10 Black GA42 Crimson GA90 Navy</p> <p>G A 1 0 .</p> | <p>Select Frame</p> <p>T Black</p> <p>T</p> |
|---|---|---|



VOLT® 5710 Series

H5711



TASK CHAIR

Mesh Back
Pneumatic
Swivel
Tilt
Tilt Tension
Tilt Lock
Functions: **A, E, F, K, L**
(Function Key on pages 18-19)

DIMENSIONS

Depth: 25³/₄
Width: 26
Height: 38³/₄
Seat Depth: 18³/₄
Seat Width: 19¹/₄
Back Width: 18
Back Height: 18³/₄
Seat to Floor Height: 18³/₄-22³/₈
Usable Seat Depth: 18
Ship Weight: 29 **Ⓢ**
Cube: 4.8
COM: 1.5
Weight Rating: 250 lbs.

FABRIC PRICE CODES

1 \$324 L \$354

H5713



TASK CHAIR

Mesh Back
Pneumatic
Swivel
Synchro-tilt
Tilt Tension
Tilt Lock
Functions: **A, E, J, K, L**
(Function Key on pages 18-19)

DIMENSIONS

Depth: 25³/₄
Width: 26
Height: 38¹/₂
Seat Depth: 18³/₄
Seat Width: 19¹/₄
Back Width: 18
Back Height: 18³/₄
Seat to Floor Height: 17³/₈-21¹/₈
Usable Seat Depth: 17⁷/₈
Ship Weight: 32 **Ⓢ**
Cube: 4.8
COM: 1.5
Weight Rating: 250 lbs.

FABRIC PRICE CODES

1 \$364 L \$394

H5715



TASK STOOL

Mesh Back
Pneumatic
Swivel
Adjustable Footring
Functions: **A, E**
(Function Key on pages 18-19)

DIMENSIONS

Depth: 28
Width: 26
Height: 49⁷/₈
Seat Depth: 20
Seat Width: 19
Back Width: 18
Back Height: 18¹/₂
Seat to Floor Height: 22⁷/₈-32³/₈
Usable Seat Depth: 18
Ship Weight: 36 **Ⓢ**
Cube: 5.6
COM: 1.5
Weight Rating: 250 lbs.

FABRIC PRICE CODES

1 \$478 L \$508

H5795

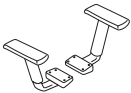

HEIGHT-ADJUSTABLE ARMS

Non-upholstered
Functions: **Q**
(Function Key on pages 18-19)

DIMENSIONS

Adjustable Arms Width: 17³/₈
Height from Seat: 7⁵/₈-10⁵/₈
Ship Weight: 5 **Ⓢ**
Cube: 0.6

LIST PRICE

\$74

HON Recommendation: H5713.GA10.T with H5795 Arm Pack - List Price \$438

HOW TO SPECIFY

Select Model Number

H 5 7 1 3 .

Select Fabric

SB11 Black Leather
GA10 Black
GA42 Crimson
GA90 Navy

G A 1 0 .

Select Frame

T Black

T

VOLT® 5720/5730 Series Options

MODEL OPTIONS

H5721



Task Chair

Pneumatic, Swivel, Tilt, Tilt Tension, Tilt Lock

H5723



Task Chair

Pneumatic, Swivel, Synchro-tilt, Tilt Tension, Tilt Lock

H5725



Task Stool

Pneumatic, Swivel, Adjustable Footring

H5731



Task Chair (Mesh Back)

Pneumatic, Swivel, Tilt, Tilt Tension, Tilt Lock

H5733



Task Chair (Mesh Back)

Pneumatic, Swivel, Synchro-tilt, Tilt Tension, Tilt Lock

H5735



Task Stool (Mesh Back)

Pneumatic, Swivel, Adjustable Footring

CASTERS



| CODE | DESCRIPTION | PRICE |
|----------|-------------|-------------|
| H | Hard Caster | +\$0 |



| | | |
|----------|-------------|--------------|
| S | Soft Caster | +\$30 |
|----------|-------------|--------------|

FRAME

| CODE | DESCRIPTION | PRICE |
|----------|-------------|-------------|
| T | Black | +\$0 |

5720/5730 Series Fabric Options

HON BRANDED FABRICS

GRADE 1

Attire
 Centurion
 Compass
 Contourette Polyurethane
 Dapper
 Hamilton
 Inertia
 Optic

GRADE 2

Appoint Seating
 Clyde
 Dotty
 Rush
 Seed
 Spin Seating
 Whisper Vinyl

GRADE 3

In Season
 Purl
 Silvertex™ Vinyl

For a complete list of fabrics, including partnership fabrics, go to hon.com/fabricsandfinishes.

Reference Fabric Color Combinations on pages 20-24 for color codes and legend on page 21 for lead times. For additional HON to Supply COM fabric grade pricing, go to honready.hon.com and click on the HON to Supply COM link.

 For Fire Code model, availability and ordering method, refer to pages 28-31. Available on select models, contact HON Customer Support for availability.

VOLT® 5720 Series

GSA SIN 711-18 EXCEPT AS NOTED



Icon Legend on page 17

H5721



TASK CHAIR

Pneumatic
Swivel
Tilt
Tilt Tension
Tilt Lock

Functions: **A, E, F, K, L**
(Function Key on pages 18-19)

DIMENSIONS

| | | | |
|--------------|--------------------------------|-----------------------|--|
| Depth: | 25 ³ / ₄ | Seat to Floor Height: | 17 ¹ / ₄ -22 ¹ / ₄ |
| Width: | 25 ³ / ₄ | Usable Seat Depth: | 18 ³ / ₄ |
| Height: | 40 | Ship Weight: | 36 |
| Seat Depth: | 18 ³ / ₄ | Cube: | 11.3 |
| Seat Width: | 18 ¹ / ₂ | Weight Rating: | 250 lbs. |
| Back Width: | 17 ¹ / ₄ | | |
| Back Height: | 18 ³ / ₄ | | |

FABRIC PRICE CODES

| | | | |
|---|-------|----|-------|
| 1 | \$307 | 8 | \$445 |
| 2 | \$331 | 9 | \$463 |
| 3 | \$355 | 10 | \$481 |
| 4 | \$373 | 11 | \$499 |
| 5 | \$391 | 12 | \$517 |
| 6 | \$409 | L | — |
| 7 | \$427 | | |

H5723



TASK CHAIR

Pneumatic
Swivel
Synchro-tilt
Tilt Tension
Tilt Lock

Functions: **A, E, J, K, L**
(Function Key on pages 18-19)

DIMENSIONS

| | | | |
|--------------|--------------------------------|-----------------------|--|
| Depth: | 25 ³ / ₄ | Seat to Floor Height: | 17 ¹ / ₄ -22 ¹ / ₄ |
| Width: | 25 ³ / ₄ | Usable Seat Depth: | 18 ³ / ₄ |
| Height: | 40 | Ship Weight: | 38 |
| Seat Depth: | 18 ³ / ₄ | Cube: | 11.3 |
| Seat Width: | 18 ¹ / ₂ | Weight Rating: | 250 lbs. |
| Back Width: | 17 ¹ / ₄ | | |
| Back Height: | 18 ³ / ₄ | | |

FABRIC PRICE CODES

| | | | |
|---|-------|----|-------|
| 1 | \$343 | 8 | \$481 |
| 2 | \$367 | 9 | \$499 |
| 3 | \$391 | 10 | \$517 |
| 4 | \$409 | 11 | \$535 |
| 5 | \$427 | 12 | \$553 |
| 6 | \$445 | L | — |
| 7 | \$463 | | |

H5725

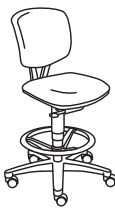

TASK STOOL

Pneumatic
Swivel
Adjustable Footring

Functions: **A, E**
(Function Key on pages 18-19)

DIMENSIONS

| | | | |
|--------------|--------------------------------|-----------------------|--|
| Depth: | 29 ¹ / ₂ | Seat to Floor Height: | 22 ⁷ / ₈ -32 ³ / ₈ |
| Width: | 27 | Usable Seat Depth: | 18 ³ / ₄ |
| Height: | 49 ⁷ / ₈ | Ship Weight: | 39 |
| Seat Depth: | 20 | Cube: | 11.3 |
| Seat Width: | 19 | Weight Rating: | 250 lbs. |
| Back Width: | 17 ¹ / ₄ | | |
| Back Height: | 18 ³ / ₄ | | |

FABRIC PRICE CODES

| | | | |
|---|-------|----|-------|
| 1 | \$447 | 8 | \$585 |
| 2 | \$471 | 9 | \$603 |
| 3 | \$495 | 10 | \$621 |
| 4 | \$513 | 11 | \$639 |
| 5 | \$531 | 12 | \$657 |
| 6 | \$549 | L | — |
| 7 | \$567 | | |

H5795

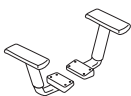

OPEN MARKET

HEIGHT-ADJUSTABLE ARMS

Non-upholstered

Functions: **Q**
(Function Key on pages 18-19)

DIMENSIONS

| | |
|------------------------|---|
| Adjustable Arms Width: | 17 ³ / ₈ |
| Height from Seat: | 7 ⁵ / ₈ -10 ⁵ / ₈ |
| Ship Weight: | 5 |
| Cube: | 0.6 |

LIST PRICE

\$74

HON Recommendation: H5723.H.CU__T with H5795 Arm Pack - List Price \$417

HOW TO SPECIFY

| | | | |
|---|---|---|---|
| Select Model Number <div style="border: 1px solid black; padding: 2px; display: flex; gap: 5px;"> H5723 </div> | Select Caster H Hard Caster S Soft Caster (+ \$30) | Select Fabric See page 303 <div style="border: 1px solid black; padding: 2px; display: flex; gap: 5px;"> CU10 </div> | Select Frame T Black |
|---|---|---|---|



Icon Legend on page 17

VOLT® 5730 Series

H5731



TASK CHAIR

Mesh Back
Pneumatic
Swivel
Tilt
Tilt Tension
Tilt Lock
Functions: **A, E, F, K, L**
(Function Key on pages 18-19)

DIMENSIONS

Depth: 25³/₄ Seat to Floor Height: 18¹/₄-22³/₈
Width: 26 Usable Seat Depth: 18
Height: 38³/₄ Ship Weight: 29 **Ⓢ**
Seat Depth: 18³/₄ Cube: 4.8
Seat Width: 19¹/₄ COM: 1.5
Back Width: 18 Weight Rating: 250 lbs.
Back Height: 18³/₄

FABRIC PRICE CODES

| | | | |
|---|-------|----|-------|
| 1 | \$400 | 8 | \$469 |
| 2 | \$412 | 9 | \$478 |
| 3 | \$424 | 10 | \$487 |
| 4 | \$433 | 11 | \$496 |
| 5 | \$442 | 12 | \$505 |
| 6 | \$451 | L | — |
| 7 | \$460 | | |

H5733



TASK CHAIR

Mesh Back
Pneumatic
Swivel
Synchro-tilt
Tilt Tension
Tilt Lock
Functions: **A, E, J, K, L**
(Function Key on pages 18-19)

DIMENSIONS

Depth: 25³/₄ Seat to Floor Height: 17³/₈-21¹/₈
Width: 26 Usable Seat Depth: 17⁷/₈
Height: 38¹/₂ Ship Weight: 32 **Ⓢ**
Seat Depth: 18³/₄ Cube: 4.8
Seat Width: 19¹/₄ COM: 1.5
Back Width: 18 Weight Rating: 250 lbs.
Back Height: 18³/₄

FABRIC PRICE CODES

| | | | |
|---|-------|----|-------|
| 1 | \$437 | 8 | \$506 |
| 2 | \$449 | 9 | \$515 |
| 3 | \$461 | 10 | \$524 |
| 4 | \$470 | 11 | \$533 |
| 5 | \$479 | 12 | \$542 |
| 6 | \$488 | L | — |
| 7 | \$497 | | |

H5735



TASK STOOL

Mesh Back
Pneumatic
Swivel
Adjustable Footring
Functions: **A, E**
(Function Key on pages 18-19)

DIMENSIONS

Depth: 28 Seat to Floor Height: 22⁷/₈-32³/₈
Width: 26 Usable Seat Depth: 18
Height: 49⁷/₈ Ship Weight: 36 **Ⓢ**
Seat Depth: 20 Cube: 5.6
Seat Width: 19 COM: 1.5
Back Width: 18 Weight Rating: 250 lbs.
Back Height: 18¹/₂

FABRIC PRICE CODES

| | | | |
|---|-------|----|-------|
| 1 | \$544 | 8 | \$613 |
| 2 | \$556 | 9 | \$622 |
| 3 | \$568 | 10 | \$631 |
| 4 | \$577 | 11 | \$640 |
| 5 | \$586 | 12 | \$649 |
| 6 | \$595 | L | — |
| 7 | \$604 | | |

H5795

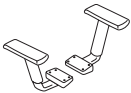

HEIGHT-ADJUSTABLE ARMS

Non-upholstered
Functions: **Q**
(Function Key on pages 18-19)

DIMENSIONS

Adjustable Arms Width: 17³/₈
Height from Seat: 7³/₈-10³/₈
Ship Weight: 5 **Ⓢ**
Cube: 0.6

LIST PRICE

\$74

HON Recommendation: H5733.H.CU__T with H5795 Arm Pack - List Price \$511

HOW TO SPECIFY

| | | | |
|--|--|---|--|
| <p>Select Model Number</p> <p>H 5 7 3 3</p> | <p>Select Caster</p> <p>H Hard Caster S Soft Caster (+ \$30)</p> <p>H</p> | <p>Select Fabric</p> <p>See page 303</p> <p>CU10</p> | <p>Select Frame</p> <p>T Black</p> <p>T</p> |
|--|--|---|--|

WAVE™ Mesh Chairs

GSA SIN AS NOTED



Icon Legend on page 17

HVL701



SIN 711-18

HIGH-BACK

Pneumatic
Swivel
Knee Tilt
Tilt Tension
Infinite Tilt Lock
Adjustable Lumbar
Height-adjustable Arms

Functions: **A, E, H, K, L, Q, W**
(Function Key on pages 18-19)

DIMENSIONS

| | | | |
|--------------|-----|-----------------------|----------|
| Depth: | 28 | Arm Width: | 19½ |
| Width: | 27½ | Seat to Floor Height: | 18½-21¼ |
| Height: | 44⅝ | Usable Seat Depth: | 19¼ |
| Seat Depth: | 20¾ | Ship Weight: | 53 Ⓢ |
| Seat Width: | 22 | Cube: | 5.8 |
| Back Width: | 23 | Weight Rating: | 250 lbs. |
| Back Height: | 23¾ | | |

PRICE CODE

Leather **\$633**

NOTES: Comfortable and breathable mesh back. Sturdy textured black frame. HVL701 has a Black leather upholstered seat with side mesh panels. Adjustable lumbar support. **HON 5-Year Limited Warranty.**

HON Recommendation: HVL701.SB11 - List Price \$633

HVL702



OPEN MARKET

HIGH-BACK

Pneumatic
Swivel
Synchro-tilt
Tilt Tension
Tilt Lock
Height-adjustable Arms

Functions: **A, E, J, K, L, Q**
(Function Key on pages 18-19)

DIMENSIONS

| | | | |
|--------------|-----|-----------------------|----------|
| Depth: | 26½ | Arm Width: | 19½ |
| Width: | 26½ | Seat to Floor Height: | 18½-23½ |
| Height: | 40½ | Usable Seat Depth: | 19¾ |
| Seat Depth: | 19¾ | Ship Weight: | 40 Ⓢ |
| Seat Width: | 21 | Cube: | 5.0 |
| Back Width: | 19½ | Weight Rating: | 250 lbs. |
| Back Height: | 24 | | |

PRICE CODE

Sandwich Mesh **\$513**

NOTES: Black Sandwich Mesh seat and mesh back. **HON 5-Year Limited Warranty.**

HON Recommendation: HVL702.MM10 - List Price \$513

HVL705



OPEN MARKET

EXECUTIVE BIG AND TALL

Pneumatic
Knee Tilt
Tilt Tension
Tilt Lock
Height and Width Adjustable Arms
Integrated Lumbar Support

Functions: **A, E, H, K, L, S**
(Function Key on pages 18-19)

DIMENSIONS

| | | | |
|-------------|-----|-----------------------|----------|
| Depth: | 25⅝ | Back Height: | 28 |
| Width: | 30¼ | Seat to Floor Height: | 19¼-22¼ |
| Height: | 42⅝ | Usable Seat Depth: | 18¾ |
| Seat Depth: | 18¾ | Ship Weight: | 59 Ⓢ |
| Seat Width: | 21⅝ | Cube: | 6.1 |
| Back Width: | 22¾ | Weight Rating: | 450 lbs. |

PRICE CODE

Mesh **\$756**

NOTES: Large scale model HVL705 will support up to 450 lbs with normal use. Available in Black Mesh fabric VM10. **HON 5-Year Limited Warranty.**

HON Recommendation: HVL705.VM10 - List Price \$756

HVL712



SIN 711-18

MID-BACK

Pneumatic
Swivel
Synchro-tilt
Tilt Tension
Tilt Lock
Height-adjustable Arms

Functions: **A, E, J, K, L, Q**
(Function Key on pages 18-19)

DIMENSIONS

| | | | |
|--------------|-----|-----------------------|----------|
| Depth: | 28½ | Arm Width: | 18⅝ |
| Width: | 29½ | Seat to Floor Height: | 18-22¼ |
| Height: | 41¾ | Usable Seat Depth: | 18 |
| Seat Depth: | 18½ | Ship Weight: | 39 Ⓢ |
| Seat Width: | 19¾ | Cube: | 5.4 |
| Back Width: | 20½ | Weight Rating: | 250 lbs. |
| Back Height: | 20¾ | | |

PRICE CODE

Sandwich Mesh **\$435**

NOTES: Black Sandwich Mesh seat and mesh back. **HON 5-Year Limited Warranty.**

HON Recommendation: HVL712.MM10 - List Price \$435

HOW TO SPECIFY

| | |
|---|---|
| <p>Select Model Number</p> <p>HVL701</p> | <p>Select Fabric</p> <p>SB11 Black SofThread™ Leather <i>Specify for model HVL701 only</i></p> <p>MM10 Black Sandwich Mesh Fabric <i>Specify for models HVL702 and HVL712 only</i></p> <p>VM10 Black Mesh Fabric <i>Specify for model HVL705 only</i></p> <p>SB11</p> |
|---|---|

2400 SERIES



2400 Guest Chair shown with Park Avenue 5000 Executive Chair and Concinnity Series Desk.

2400 SERIES

Comfort that lasts all day. A sturdy foundation that lasts for years. 2400 Series guest seating combines both to provide an attractive solution for any welcoming or waiting area. The contoured back cushion is designed to offer additional lumbar support and targeted comfort. The solid hardwood frame is available in a variety of rich woodgrain finishes, and the fixed arms provide valuable upper body support. For any number of applications or spaces, your magic number is 2400.



FEATURES

- Contoured back design enhances lumbar support.
- Fully-upholstered outer back.
- Solid hardwood frame is available in one of eight attractive finishes.
- Thick seat and back cushioning deliver exceptional comfort.
- Fixed arms increase upper body support.
- Available in hundreds of quality HON fabrics.
- Warranted for users up to 250 lbs.

2400 SERIES Options

MODEL OPTIONS

H2403



Guest Chair

Sled Base, Wood Arms

AVAILABLE FINISHES

2400 Series Seating is available in 7 wood finishes.

WOOD FINISHES

Bourbon Cherry (H)

Cognac (COGN)

Harvest (C)

Mahogany (N)

Mocha (MOCH)

Pinnacle (PINC)

Shaker Cherry (F)

HON BRANDED FABRICS

GRADE 1

Attire
Centurion
Compass
Contourette Polyurethane
Dapper
Hamilton
Inertia
Optic

GRADE 2

Appoint Seating
Clyde
Dotty
Rush
Seed
Spin Seating
Whisper Vinyl

GRADE 3

In Season
Purl
Silvertext™ Vinyl

GRADE L

Denver Leather

For a complete list of fabrics, including partnership fabrics, go to hon.com/fabricsandfinishes.

Reference Fabric Color Combinations on pages 20-24 for color codes and legend on page 21 for lead times. COM yardage shown is for Pattern Cut only. Contact Customer Service for Railroaded yardage requirements. For additional HON to Supply COM fabric grade pricing, go to honready.hon.com and click on the HON to Supply COM link.

 For Fire Code model, availability and ordering method, refer to pages 28-31. Available on select models, contact HON Customer Support for availability.



Icon Legend on page 17

2400 SERIES

H2403



GUEST CHAIR

Sled Base
Wood Arms

DIMENSIONS

| | | | |
|--------------|-----|-----------------------|----------|
| Depth: | 25½ | Arm Width: | 19½ |
| Width: | 22¾ | Seat to Floor Height: | 18½ |
| Height: | 32½ | Usable Seat Depth: | 19 |
| Seat Depth: | 20 | Ship Weight: | 37 |
| Seat Width: | 20 | Cube: | 18.4 |
| Back Width: | 19¾ | COM: | 2.0 |
| Back Height: | 16 | Weight Rating: | 250 lbs. |

FABRIC PRICE CODES

| | | | |
|---|-------|----|-------|
| 1 | \$572 | 8 | \$848 |
| 2 | \$620 | 9 | \$884 |
| 3 | \$668 | 10 | \$920 |
| 4 | \$704 | 11 | \$956 |
| 5 | \$740 | 12 | \$992 |
| 6 | \$776 | L | \$972 |
| 7 | \$812 | | |

HON Recommendation: H2403.MOCH.CU__ - List Price \$572

HOW TO SPECIFY

Select
Model Number

H 2 4 0 3 .

Select
Finish

See page 308

M O C H .

Select
Fabric

See page 308

C U 1 0 .

6540 SERIES



6540 Series Executive High-Back and Guest Chair with 94000 Series™ desks.

6540 SERIES

18th century style meets 21st century engineering in the 6540 Series. Classic details create a dignified aesthetic, while modern control mechanisms deliver advanced support and comfort. The high-back executive chair and matching guest chair also feature a crested-back design, scalloped seat front with buttons on the seat back, brass nailhead trim and scrolled wood accents. Go back in time, without sacrificing the comforts of today.



FEATURES

- Executive chair features mid-range knee-tilt mechanism to allow for a natural, comfortable recline.
- Fully-upholstered outer back.
- Crested-back design features scalloped seat front, buttons on the seat back, brass nailhead trim and scrolled wood accents.
- Contoured back design enhances lumbar support.
- Coordinating guest chair also available.
- Brass, dual-wheeled, hooded casters roll effortlessly and quietly.
- Solid hardwood in one of eight attractive finishes.
- Warranted for users up to 275 lbs.

6540 SERIES Options

MODEL OPTIONS

H6541



Executive High-Back

Pneumatic, Swivel, Mid-range Knee Tilt, Tilt Tension, Tilt Lock, Upholstered Arms

H6545



Guest Chair

Leg Base, Upholstered Arms

HON BRANDED FABRICS

GRADE 1

Centurion
Contourette Polyurethane
Hamilton

GRADE 2

Appoint Seating
Dotty
Rush
Whisper Vinyl

GRADE 3

Silvertex™ Vinyl

GRADE L

Denver Leather

For a complete list of fabrics, including partnership fabrics, go to hon.com/fabricsandfinishes.

Reference Fabric Color Combinations on pages 20-24 for color codes and legend on page 21 for lead times. COM yardage shown is for Pattern Cut only. Contact Customer Service for Railroaded yardage requirements. For additional HON to Supply COM fabric grade pricing, go to honready.hon.com and click on the HON to Supply COM link.

 For Fire Code model, availability and ordering method, refer to pages 28-31. Available on select models, contact HON Customer Support for availability.

AVAILABLE FINISHES

6540 Series Seating is available in 7 wood finishes.

WOOD FINISHES

Bourbon Cherry (H)

Cognac (COGN)

Harvest (C)

Mahogany (N)

Mocha (MOCH)

Pinnacle (PINC)

Shaker Cherry (F)



Icon Legend on page 17

6540 SERIES

H6541



EXECUTIVE HIGH-BACK

Pneumatic
Swivel
Mid-range Knee Tilt
Tilt Tension
Tilt Lock
Upholstered Arms
Functions: **A, E, G, K, L**
(Function Key on pages 18-19)

DIMENSIONS

| | | | |
|--------------|-----|-----------------------|----------|
| Depth: | 29½ | Arm Width: | 19 |
| Width: | 25¾ | Seat to Floor Height: | 16⅞-22⅞ |
| Height: | 44¾ | Usable Seat Depth: | 19 |
| Seat Depth: | 19¾ | Ship Weight: | 68 |
| Seat Width: | 21½ | Cube: | 23.7 |
| Back Width: | 21 | COM: | 2.5 |
| Back Height: | 25½ | Weight Rating: | 250 lbs. |

FABRIC PRICE CODES

| | | | |
|---|--------|----|--------|
| 1 | \$1082 | 8 | \$1427 |
| 2 | \$1142 | 9 | \$1472 |
| 3 | \$1202 | 10 | \$1517 |
| 4 | \$1247 | 11 | \$1562 |
| 5 | \$1292 | 12 | \$1607 |
| 6 | \$1337 | L | \$1582 |
| 7 | \$1382 | | |

H6545



GUEST CHAIR

Leg Base
Upholstered Arms

DIMENSIONS

| | | | |
|--------------|-----|-----------------------|----------|
| Depth: | 27½ | Arm Width: | 18½ |
| Width: | 25 | Seat to Floor Height: | 19 |
| Height: | 35¾ | Usable Seat Depth: | 18½ |
| Seat Depth: | 18½ | Ship Weight: | 40 |
| Seat Width: | 20 | Cube: | 17.3 |
| Back Width: | 22½ | COM: | 2.5 |
| Back Height: | 16¾ | Weight Rating: | 250 lbs. |

FABRIC PRICE CODES

| | | | |
|---|--------|----|--------|
| 1 | \$826 | 8 | \$1171 |
| 2 | \$886 | 9 | \$1216 |
| 3 | \$946 | 10 | \$1261 |
| 4 | \$991 | 11 | \$1306 |
| 5 | \$1036 | 12 | \$1351 |
| 6 | \$1081 | L | \$1326 |
| 7 | \$1126 | | |

HON Recommendation: H6541.MOCH.CU__ - List Price \$1082

HOW TO SPECIFY

Select
Model Number

H 6 5 4 1 .

Select
Finish

See page 311

M O C H .

Select
Fabric

See page 311

C U 1 0

6550 SERIES



6550 Guest Chairs shown with 6540 Executive Chair and 10700 Series Desk.

6550 SERIES

Classic styling. Contemporary comfort. 6550 Series guest chairs bring the best of both to your visitors and coworkers. Whether on casters or glides, these guest chairs feature select hardwood in one of eight attractive finishes and a full upholstered back. The optional nail trim is hand-applied for an old-world look and feel. Bring a little 18th century style into your 21st century meeting and welcoming spaces with the 6550 Series.



FEATURES

- Optional hand-applied nail trim.
- All exposed wood is select hardwood.
- Solid hardwood in one of eight attractive finishes.
- Fully-upholstered outer back.
- Brass, dual-wheel, hooded casters roll effortlessly and silently.
- Warranted for users up to 250 lbs.

6550 SERIES Options

MODEL OPTIONS

H6551



Guest Chair

Open-back, Leg Base,
Upholstered Arms

H6552



Guest Chair

Open-back, Leg Base with Casters,
Upholstered Arms

NAIL TRIM



| CODE | DESCRIPTION | PRICE |
|----------|--|-------------|
| N | Standard Nail Trim (includes around arm facings and sides of back) | +\$0 |

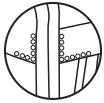

| | | |
|----------|---------------------------------|--------------|
| B | Additional Nail Trim on Seat | +\$25 |
|----------|---------------------------------|--------------|

AVAILABLE FINISHES

6550 Series Seating is available in 7 wood finishes.

WOOD FINISHES

Bourbon Cherry (H)

Cognac (COGN)

Harvest (C)

Mahogany (N)

Mocha (MOCH)

Pinnacle (PINC)

Shaker Cherry (F)

HON BRANDED FABRICS

GRADE 1

Centurion
Contourette Polyurethane
Hamilton

GRADE 2

Appoint Seating
Dotty
Rush
Whisper Vinyl

GRADE 3

Silvertex™ Vinyl

For a complete list of fabrics, including partnership fabrics, go to hon.com/fabricsandfinishes.

Reference Fabric Color Combinations on pages 20-24 for color codes and legend on page 21 for lead times. For additional HON to Supply COM fabric grade pricing, go to honready.hon.com and click on the HON to Supply COM link.

For Fire Code model, availability and ordering method, refer to pages 28-31. Available on select models, contact HON Customer Support for availability.



6550 SERIES

H6551



GUEST CHAIR

Open-back
Leg Base
Upholstered Arms

DIMENSIONS

| | | | |
|--------------|------------------|-----------------------|------------------|
| Depth: | 25 | Arm Width: | 18 $\frac{1}{8}$ |
| Width: | 24 | Seat to Floor Height: | 19 $\frac{1}{8}$ |
| Height: | 30 $\frac{1}{2}$ | Usable Seat Depth: | 20 $\frac{1}{4}$ |
| Seat Depth: | 20 $\frac{1}{4}$ | Ship Weight: | 33 |
| Seat Width: | 19 $\frac{1}{2}$ | Cube: | 18.5 |
| Back Width: | 20 $\frac{1}{8}$ | COM: | 2.0 |
| Back Height: | 12 $\frac{1}{8}$ | Weight Rating: | 250 lbs. |

FABRIC PRICE CODES

| | | | |
|---|-------|----|--------|
| 1 | \$609 | 8 | \$885 |
| 2 | \$657 | 9 | \$921 |
| 3 | \$705 | 10 | \$957 |
| 4 | \$741 | 11 | \$993 |
| 5 | \$777 | 12 | \$1029 |
| 6 | \$813 | L | — |
| 7 | \$849 | | |

H6552

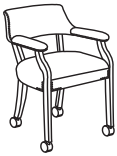

GUEST CHAIR

Open-back
Leg Base with Casters
Upholstered Arms

DIMENSIONS

| | | | |
|--------------|-------------------|-----------------------|------------------|
| Depth: | 25 | Arm Width: | 18 $\frac{1}{8}$ |
| Width: | 24 | Seat to Floor Height: | 19 $\frac{1}{8}$ |
| Height: | 30 $\frac{1}{2}$ | Usable Seat Depth: | 20 $\frac{1}{4}$ |
| Seat Depth: | 20 | Ship Weight: | 33 |
| Seat Width: | 19 $\frac{1}{2}$ | Cube: | 18.5 |
| Back Width: | 22 $\frac{1}{16}$ | COM: | 2.0 |
| Back Height: | 19 $\frac{1}{8}$ | Weight Rating: | 250 lbs. |

FABRIC PRICE CODES

| | | | |
|---|-------|----|--------|
| 1 | \$658 | 8 | \$934 |
| 2 | \$706 | 9 | \$970 |
| 3 | \$754 | 10 | \$1006 |
| 4 | \$790 | 11 | \$1042 |
| 5 | \$826 | 12 | \$1078 |
| 6 | \$862 | L | — |
| 7 | \$898 | | |

HON Recommendation: H6552.B.MOCH.CU__ - List Price \$683

HOW TO SPECIFY

| | | | |
|---|---|--|--|
| <p>Select Model Number</p> <p>H 6 5 5 2 .</p> | <p>Select Nail Trim</p> <p>B Additional Seat Nail Trim (+ \$25) N Standard Nail Trim</p> <p>B .</p> | <p>Select Finish</p> <p>See page 314</p> <p>MOCH .</p> | <p>Select Fabric</p> <p>See page 314</p> <p>CU 1 0</p> |
|---|---|--|--|

7800 SERIES



7800 Series Task Chair shown with Mentor desks.

7800 SERIES

Throw a curve at your task seating with the 7800 Series. The deeply contoured seat foam delivers ergonomic support, and the curvilinear back has integrated lumbar support for lower back. The all-adjustable arms can be moved to support a variety of positions. For anyone sitting for long periods of time, the 7800 Series has got their back.



FEATURES

- Deeply contoured foam on seat and back supports the body.
- Height- and width-adjustable arms provide a custom fit.
- Integrated lumbar support delivers long-lasting comfort.
- Model H7808 features an advanced asynchronous control that mimics the body's natural movements.
- One-touch seat height adjustment easily moves the seat up and down.
- Tilt tension controls the rate and ease of recline.
- Tilt lock allows the user to lock out the tilt function.
- 360-degree swivel provides freedom of movement in any direction.
- Control options encourage good posture.
- Fully-upholstered outer back.
- High-back models feature an integral headrest and shoulder height recess to cradle the upper spine.
- Warranted for users up to 275 lbs.

7800 SERIES Options

MODEL OPTIONS

H7803



Task Chair (High-back)

Pneumatic, Back Height, Swivel, Tilt, Tilt Tension, Tilt Lock, Posture Mechanism, Height and Width Adjustable Arms

H7808



High-Performance Task Chair (High-back)

Pneumatic, Back Height, Seat Glide Mechanism, Swivel, Tilt, Tilt Tension, Asynchronous Control, Height and Width Adjustable Arms

H7823



Task Chair (Mid-back)

Pneumatic, Back Height, Swivel, Tilt, Tilt Tension, Tilt Lock, Posture Mechanism, Height and Width Adjustable Arms

H7828



High-Performance Task Chair (Mid-back)

Pneumatic, Back Height, Seat Glide Mechanism, Swivel, Tilt, Tilt Tension, Asynchronous Control, Height and Width Adjustable Arms

CASTERS/ GLIDE



| CODE | DESCRIPTION | PRICE |
|----------|-------------|-------------|
| H | Hard Caster | +\$0 |



| | | |
|----------|-------------|--------------|
| S | Soft Caster | +\$30 |
|----------|-------------|--------------|



| | | |
|----------|------------|--------------|
| G | Bell Glide | +\$25 |
|----------|------------|--------------|

**G available for models H7823 and H7828 only*

FRAME

| CODE | DESCRIPTION | PRICE |
|----------|-------------|-------------|
| T | Black | +\$0 |

7800 SERIES

Fabric Options

HON BRANDED FABRICS

GRADE 1

Attire
Centurion
Compass
Contourette Polyurethane
Dapper
Hamilton
Inertia
Optic

GRADE 2

Appoint Seating
Clyde
Dotty
Rush
Seed
Spin Seating
Whisper Vinyl

GRADE 3

Purl
Silvertex™ Vinyl

For a complete list of fabrics, including partnership fabrics, go to hon.com/fabricsandfinishes.

Reference Fabric Color Combinations on pages 20-24 for color codes and legend on page 21 for lead times. COM yardage shown is for Pattern Cut only. Contact Customer Service for Railroaded yardage requirements. For additional HON to Supply COM fabric grade pricing, go to honready.hon.com and click on the HON to Supply COM link.

 For Fire Code model, availability and ordering method, refer to pages 28-31. Available on select models, contact HON Customer Support for availability.



Icon Legend on page 17

7800 SERIES

H7803



TASK CHAIR

High-back
 Pneumatic
 Back Height
 Swivel
 Tilt
 Tilt Tension
 Tilt Lock
 Posture Mechanism
 Height and Width Adjustable
 Arms

Functions: **A, B, E, F, K, L, M, S**
 (Function Key on pages 18-19)

DIMENSIONS

| | | | |
|--------------|--------------------------------|-----------------------|--|
| Depth: | 39 | Arm Width: | 18 ⁵ / ₈ -21 ³ / ₈ |
| Width: | 30 ¹ / ₂ | Seat to Floor Height: | 16 ³ / ₄ -20 ³ / ₄ |
| Height: | 46 ¹ / ₂ | Usable Seat Depth: | 18 |
| Seat Depth: | 18 | Ship Weight: | 62 |
| Seat Width: | 21 ¹ / ₂ | Cube: | 18.4 |
| Back Width: | 19 ³ / ₄ | COM: | 2.0 |
| Back Height: | 25 ³ / ₄ | Weight Rating: | 250 lbs. |

FABRIC PRICE CODES

| | | | |
|----------|---------------|-----------|---------------|
| 1 | \$770 | 8 | \$1046 |
| 2 | \$818 | 9 | \$1082 |
| 3 | \$866 | 10 | \$1118 |
| 4 | \$902 | 11 | \$1154 |
| 5 | \$938 | 12 | \$1190 |
| 6 | \$974 | L | — |
| 7 | \$1010 | | |

H7808



HIGH-PERFORMANCE TASK CHAIR

High-back
 Pneumatic
 Back Height
 Seat Glide Mechanism
 Swivel
 Tilt
 Tilt Tension
 Asynchronous Control
 Height and Width Adjustable
 Arms

Functions: **A, B, D, E, F, K, O, S**
 (Function Key on pages 18-19)

DIMENSIONS

| | | | |
|--------------|--------------------------------|-----------------------|--|
| Depth: | 37 | Arm Width: | 18 ⁵ / ₈ -21 ³ / ₈ |
| Width: | 30 ¹ / ₂ | Seat to Floor Height: | 18 ¹ / ₄ -21 ³ / ₄ |
| Height: | 49 | Usable Seat Depth: | 17 ¹ / ₂ -19 ³ / ₈ |
| Seat Depth: | 18 | Ship Weight: | 70 |
| Seat Width: | 21 ¹ / ₂ | Cube: | 18.4 |
| Back Width: | 19 ³ / ₄ | COM: | 2.0 |
| Back Height: | 24 ³ / ₄ | Weight Rating: | 250 lbs. |

FABRIC PRICE CODES

| | | | |
|----------|---------------|-----------|---------------|
| 1 | \$1004 | 8 | \$1280 |
| 2 | \$1052 | 9 | \$1316 |
| 3 | \$1100 | 10 | \$1352 |
| 4 | \$1136 | 11 | \$1388 |
| 5 | \$1172 | 12 | \$1424 |
| 6 | \$1208 | L | — |
| 7 | \$1244 | | |

H7895



OPEN MARKET

ADJUSTABLE ARMS

Height and Width
 Functions: **S**
 (Function Key on pages 18-19)

DIMENSIONS

| | |
|------------------------|--|
| Adjustable Arms Width: | 18 ¹ / ₂ -22 ¹ / ₄ |
| Height from Seat: | 8-11 ³ / ₈ |
| Ship Weight: | 9 |
| Cube: | 0.7 |

LIST PRICE

\$121

NOTES: Must be ordered with a configurable end product. If ordered separately, not on GSA Contract.

HON Recommendation: H7803.H.CU__T - List Price \$770

HOW TO SPECIFY

| | | | |
|--|---|--|--|
| <p>Select Model Number</p> <p>H 7 8 0 3 .</p> | <p>Select Caster</p> <p>H Hard Caster S Soft Caster (+ \$30)</p> <p>H .</p> | <p>Select Fabric</p> <p>See page 318</p> <p>C U 1 0 .</p> | <p>Select Frame</p> <p>T Black</p> <p>T .</p> |
|--|---|--|--|

7800 Series



Icon Legend on page 17

H7823



TASK CHAIR

Mid-back
 Pneumatic
 Back Height
 Swivel
 Tilt
 Tilt Tension
 Tilt Lock
 Posture Mechanism
 Height and Width Adjustable
 Arms

Functions: **A, B, E, F, K, L, M, S**
 (Function Key on pages 18-19)

DIMENSIONS

| | | | |
|--------------|-----|-----------------------|----------|
| Depth: | 31½ | Arm Width: | 18⅝-21⅝ |
| Width: | 30½ | Seat to Floor Height: | 17¼-22⅝ |
| Height: | 42 | Usable Seat Depth: | 18 |
| Seat Depth: | 18 | Ship Weight: | 55 |
| Seat Width: | 21½ | Cube: | 16.1 |
| Back Width: | 19¾ | COM: | 1.5 |
| Back Height: | 23¼ | Weight Rating: | 250 lbs. |

FABRIC PRICE CODES

| | | | |
|----------|--------------|-----------|---------------|
| 1 | \$709 | 8 | \$916 |
| 2 | \$745 | 9 | \$943 |
| 3 | \$781 | 10 | \$970 |
| 4 | \$808 | 11 | \$997 |
| 5 | \$835 | 12 | \$1024 |
| 6 | \$862 | L | — |
| 7 | \$889 | | |

H7828



HIGH-PERFORMANCE TASK CHAIR

Mid-back
 Pneumatic
 Back Height
 Seat Glide Mechanism
 Swivel
 Tilt
 Tilt Tension
 Asynchronous Control
 Height and Width
 Adjustable Arms

Functions: **A, B, D, E, F, K, O, S**
 (Function Key on pages 18-19)

DIMENSIONS

| | | | |
|--------------|---------|-----------------------|----------|
| Depth: | 35 | Arm Width: | 18⅝-21⅝ |
| Width: | 30½ | Seat to Floor Height: | 18¼-21¾ |
| Height: | 42 | Usable Seat Depth: | 17½-19⅝ |
| Seat Depth: | 18 | Ship Weight: | 63 |
| Seat Width: | 21½ | Cube: | 16.1 |
| Back Width: | 19¾ | COM: | 1.5 |
| Back Height: | 21⅞-22½ | Weight Rating: | 250 lbs. |

FABRIC PRICE CODES

| | | | |
|----------|---------------|-----------|---------------|
| 1 | \$948 | 8 | \$1155 |
| 2 | \$984 | 9 | \$1182 |
| 3 | \$1020 | 10 | \$1209 |
| 4 | \$1047 | 11 | \$1236 |
| 5 | \$1074 | 12 | \$1263 |
| 6 | \$1101 | L | — |
| 7 | \$1128 | | |

HON Recommendation: H7823.H.CU__T - List Price \$709

HOW TO SPECIFY

Select
Model Number

H 7 8 2 3 .

Select
Caster/Glide

H Hard Caster
S Soft Caster (+ \$30)
G Bell Glide (+ \$25)

H .

Select
Fabric

See page 318

C U 1 0 .

Select
Frame

T Black

T



EXECUTIVE CHAIRS

HVL105



HIGH-BACK

Pneumatic
Swivel
Tilt
Tilt Tension
Tilt Lock
Fixed Padded Arms

Functions: **A, E, F, K, L**
(Function Key on pages 18-19)

DIMENSIONS

| | | | |
|--------------|-----|-----------------------|---------------|
| Depth: | 27½ | Arm Width: | 19 |
| Width: | 25 | Seat to Floor Height: | 17½-20¼ |
| Height: | 45¾ | Usable Seat Depth: | 20¼ |
| Seat Depth: | 20¼ | Ship Weight: | 46.0 Ⓢ |
| Seat Width: | 19½ | Cube: | 6.6 |
| Back Width: | 20½ | Weight Rating: | 250 lbs. |
| Back Height: | 28¾ | | |

PRICE CODE

Leather **\$390**

NOTES: Black SofThread™ Leather. Polished base. Fixed, padded arms. **HON 5-Year Limited Warranty.**

HON Recommendation: HVL105.SB11 - List Price \$390

HVL131



HIGH-BACK

Pneumatic
Swivel
Tilt
Tilt Tension
Tilt Lock
Fixed Padded Loop Arms

Functions: **A, E, F, K, L, T**
(Function Key on pages 18-19)

DIMENSIONS

| | | | |
|--------------|-----|-----------------------|-------------|
| Depth: | 40 | Arm Width: | 20½ |
| Width: | 28½ | Seat to Floor Height: | 18½-22 |
| Height: | 45½ | Usable Seat Depth: | 18¼ |
| Seat Depth: | 18¼ | Ship Weight: | 42 Ⓢ |
| Seat Width: | 20¾ | Cube: | 6.3 |
| Back Width: | 20¾ | Weight Rating: | 250 lbs. |
| Back Height: | 26⅞ | | |

PRICE CODE

Vinyl **\$332**

NOTES: Black vinyl with contrasting top stitch. Black frame. Padded loop arms. **HON 5-Year Limited Warranty.**

HON Recommendation: HVL131.EN11 - List Price \$332

HVL151



HIGH-BACK

Pneumatic
Swivel
Tilt
Tilt Tension
Tilt Lock
Fixed Padded Loop Arms

Functions: **A, E, F, K, L, T**
(Function Key on pages 18-19)

DIMENSIONS

| | | | |
|--------------|-----|-----------------------|-------------|
| Depth: | 37½ | Arm Width: | 20½ |
| Width: | 27 | Seat to Floor Height: | 17¾-21½ |
| Height: | 45½ | Usable Seat Depth: | 18⅝ |
| Seat Depth: | 18⅝ | Ship Weight: | 38 Ⓢ |
| Seat Width: | 20½ | Cube: | 5.1 |
| Back Width: | 20½ | Weight Rating: | 250 lbs. |
| Back Height: | 27¼ | | |

PRICE CODE

Leather **\$303**

NOTES: Black SofThread™ Leather. Black frame. Padded loop arms. **HON 5-Year Limited Warranty.**

HON Recommendation: HVL151.SB11 - List Price \$303

HOW TO SPECIFY

Select
Model Number

Select
Fabric

- SB11** Black SofThread™ Leather
Specify for models HVL105 and HVL151 only
- EN11** Black Vinyl
Specify for model HVL131 only

H V L 1 0 5 .

S B 1 1



EXECUTIVE CHAIRS

HVL161



HIGH-BACK

Pneumatic
Swivel
Tilt
Tilt Tension
Tilt Lock
Fixed Padded Loop Arms

Functions: **A, E, F, K, L, T**
(Function Key on pages 18-19)

DIMENSIONS

| | | | |
|--------------|------------------|-----------------------|------------------------------------|
| Depth: | 39 $\frac{1}{4}$ | Arm Width: | 19 |
| Width: | 25 $\frac{5}{8}$ | Seat to Floor Height: | 18 $\frac{3}{8}$ -22 $\frac{1}{8}$ |
| Height: | 45 | Usable Seat Depth: | 18 $\frac{3}{4}$ |
| Seat Depth: | 18 $\frac{3}{4}$ | Ship Weight: | 35 Ⓢ |
| Seat Width: | 19 | Cube: | 4.8 |
| Back Width: | 19 | Weight Rating: | 250 lbs. |
| Back Height: | 26 $\frac{3}{8}$ | | |

PRICE CODE

Leather **\$269**

NOTES: Black SofThread™ Leather. Black frame. Padded loop arms. **HON 5-Year Limited Warranty.**

HON Recommendation: HVL161.SB11 - List Price \$269

HVL171



MID-BACK

Pneumatic
Swivel
Tilt
Tilt Tension
Tilt Lock
Fixed Loop Arms

Functions: **A, E, F, K, L, T**
(Function Key on pages 18-19)

DIMENSIONS

| | | | |
|--------------|------------------|-----------------------|------------------------------------|
| Depth: | 34 $\frac{1}{2}$ | Arm Width: | 19 $\frac{3}{8}$ |
| Width: | 25 $\frac{5}{8}$ | Seat to Floor Height: | 16 $\frac{3}{4}$ -20 $\frac{1}{2}$ |
| Height: | 38 $\frac{3}{4}$ | Usable Seat Depth: | 17 $\frac{3}{4}$ |
| Seat Depth: | 17 $\frac{3}{4}$ | Ship Weight: | 26 Ⓢ |
| Seat Width: | 19 $\frac{3}{8}$ | Cube: | 3.9 |
| Back Width: | 18 $\frac{3}{4}$ | Weight Rating: | 250 lbs. |
| Back Height: | 21 $\frac{1}{4}$ | | |

PRICE CODE

Leather **\$218**

NOTES: Black SofThread™ Leather. Black frame. Loop arms. **HON 5-Year Limited Warranty.**

HON Recommendation: HVL171.SB11 - List Price \$218

HVL402



HIGH-BACK

Pneumatic
Swivel
Tilt
Tilt Tension
Tilt Lock
Fixed Padded Loop Arms

Functions: **A, E, F, K, L, T**
(Function Key on pages 18-19)

DIMENSIONS

| | | | |
|--------------|------------------|-----------------------|------------------------------------|
| Depth: | 28 | Arm Width: | 19 $\frac{1}{2}$ |
| Width: | 26 | Seat to Floor Height: | 16 $\frac{1}{2}$ -20 $\frac{1}{2}$ |
| Height: | 45 $\frac{1}{2}$ | Usable Seat Depth: | 17 $\frac{1}{2}$ |
| Seat Depth: | 17 $\frac{1}{2}$ | Ship Weight: | 44 Ⓢ |
| Seat Width: | 19 $\frac{1}{2}$ | Cube: | 6.1 |
| Back Width: | 19 | Weight Rating: | 250 lbs. |
| Back Height: | 24 $\frac{1}{2}$ | | |

PRICE CODE

Vinyl **\$334**

NOTES: Available in Black and Brown vinyl with contrasting top stitch. EN11 features silver frame. EN45 features black frame. Padded loop arms. **HON 5-Year Limited Warranty.**

HON Recommendation: HVL402.EN11 - List Price \$334

HOW TO SPECIFY

Select Model Number

Select Fabric

- SB11** Black SofThread™ Leather
Specify for models HVL161 and HVL171
- EN11** Black Vinyl
Specify for model HVL402 only
- EN45** Brown Vinyl
Specify for model HVL402 only

H V L 1 6 1 .

S B 1 1



EXECUTIVE CHAIRS

HVL601



HIGH-BACK

- Pneumatic
- Swivel
- Tilt
- Tilt Tension
- Tilt Lock
- Loop Arms

Functions: **A, E, F, K, L, T**
(Function Key on pages 18-19)

DIMENSIONS

| | | | |
|--------------|-----|-----------------------|-------------|
| Depth: | 27 | Arm Width: | 20½ |
| Width: | 26½ | Seat to Floor Height: | 16¾-20½ |
| Height: | 44 | Usable Seat Depth: | 17 |
| Seat Depth: | 17 | Ship Weight: | 38 Ⓢ |
| Seat Width: | 20½ | Cube: | 4.1 |
| Back Width: | 20½ | Weight Rating: | 250 lbs. |
| Back Height: | 26½ | | |

PRICE CODE

| | |
|----------------|--------------|
| Fabric | \$219 |
| Leather | \$249 |

NOTES: Tailored stitching detail in Black SofThread™ Leather or Black, Charcoal, Burgundy or Navy fabric. Fixed loop arms. Black frame.

HON 5-Year Limited Warranty.

HON Recommendation: HVL601.SB11 - List Price \$249

HOW TO SPECIFY

| Select Model Number | Select Fabric |
|---------------------|---|
| | SB11 Black SofThread™ Leather VA10 Black Fabric VA19 Charcoal Fabric VA62 Burgundy Fabric VA90 Navy Fabric |
| HVL601 | SB11 |



GUEST CHAIRS

HVL443



GUEST CHAIR

Sled Base
Padded Arms

DIMENSIONS

| | | | |
|--------------|-----|-----------------------|----------|
| Depth: | 25½ | Arm Width: | 20 |
| Width: | 23¼ | Seat to Floor Height: | 18½ |
| Height: | 34½ | Usable Seat Depth: | 18 |
| Seat Depth: | 18½ | Ship Weight: | 35 |
| Seat Width: | 20½ | Cube: | 4.1 |
| Back Width: | 20 | Weight Rating: | 250 lbs. |
| Back Height: | 16 | | |

PRICE CODE

Fabric **\$270**

NOTES: Coordinates in any office environment or reception area. Sturdy, welded metal sled base frame. Sleek fabric covered back and seat cushions. Fabric covered outer back. Padded arm rests. Built-in lumbar support. **HON 5-Year Limited Warranty.**

HON Recommendation: HVL443.VC10 - List Price \$270

HVL653



GUEST CHAIR

Sled Base
Padded Arms

DIMENSIONS

| | | | |
|--------------|-----|-----------------------|----------|
| Depth: | 23 | Arm Width: | 17¾ |
| Width: | 22¼ | Seat to Floor Height: | 17⅝ |
| Height: | 32 | Usable Seat Depth: | 16¾ |
| Seat Depth: | 17 | Ship Weight: | 28 |
| Seat Width: | 20¼ | Cube: | 3.1 |
| Back Width: | 18½ | Weight Rating: | 250 lbs. |
| Back Height: | 12 | | |

PRICE CODE

Leather **\$192**

NOTES: Black SofThread™ Leather with tailored stitching detail. Frame features steel tubular construction. Black frame.

HON Recommendation: HVL653.SB11 - List Price \$192

HOW TO SPECIFY

| | | | | | | | | | | | |
|---|---|---|---|---|---|---|---|---|---|---|---|
| <p>Select Model Number</p> | <p>Select Fabric</p> <p>VC10 Black Fabric <i>Available on HVL443 only</i></p> <p>SB11 Black SofThread™ Leather <i>Available on HVL653 only</i></p> | | | | | | | | | | |
| <table border="1" style="display: inline-table; border-collapse: collapse;"> <tr> <td>H</td><td>V</td><td>L</td><td>4</td><td>4</td><td>3</td> </tr> </table> | H | V | L | 4 | 4 | 3 | <table border="1" style="display: inline-table; border-collapse: collapse;"> <tr> <td>V</td><td>C</td><td>1</td><td>0</td> </tr> </table> | V | C | 1 | 0 |
| H | V | L | 4 | 4 | 3 | | | | | | |
| V | C | 1 | 0 | | | | | | | | |



MESH CHAIRS

HVL521



OPEN MARKET

MID-BACK

Pneumatic
Swivel
Tilt
Tilt Tension
Tilt Lock
Arms

Functions: **A, E, F, K, L**
(Function Key on pages 18-19)

DIMENSIONS

| | | | |
|--------------|-----|-----------------------|-------------|
| Depth: | 35¼ | Arm Width: | 18½ |
| Width: | 26¼ | Seat to Floor Height: | 17½-22 |
| Height: | 41 | Usable Seat Depth: | 17¾ |
| Seat Depth: | 17¾ | Ship Weight: | 30 Ⓢ |
| Seat Width: | 19½ | Cube: | 4.1 |
| Back Width: | 18¾ | Weight Rating: | 250 lbs. |
| Back Height: | 21½ | | |

PRICE CODE

Fabric **\$249**

NOTES: Comfortable and breathable mesh back. Black fabric seat. Sturdy textured black frame. Fixed-height arms. **HON 5-Year Limited Warranty.**

HON Recommendation: HVL521.VA10 - List Price \$249

HVL525



OPEN MARKET

HIGH-BACK

Pneumatic
Swivel
Tilt
Tilt Tension
Tilt Lock
Fixed Loop Arms

Functions: **A, E, F, K, L, T**
(Function Key on pages 18-19)

DIMENSIONS

| | | | |
|--------------|-----|-----------------------|-------------|
| Depth: | 26 | Arm Width: | 20⅞ |
| Width: | 26 | Seat to Floor Height: | 16¾-21¼ |
| Height: | 42¾ | Usable Seat Depth: | 19 |
| Seat Depth: | 19 | Ship Weight: | 33 Ⓢ |
| Seat Width: | 19¾ | Cube: | 3.8 |
| Back Width: | 19¾ | Weight Rating: | 250 lbs. |
| Back Height: | 23 | | |

PRICE CODE

Fabric **\$253**

NOTES: Comfortable and breathable mesh back. Black upholstered seat. Fixed, loop arms. **HON 5-Year Limited Warranty.**

HON Recommendation: HVL525.ES10 - List Price \$253

HVL551



SIN 711-18

MID-BACK

Pneumatic
Swivel
Tilt
Tilt Tension
Tilt Lock
Height-adjustable Arms

Functions: **A, E, F, K, L, Q**
(Function Key on pages 18-19)

DIMENSIONS

| | | | |
|--------------|-----|-----------------------|-------------|
| Depth: | 29 | Arm Width: | 19 |
| Width: | 26 | Seat to Floor Height: | 18⅞-22⅜ |
| Height: | 39¾ | Usable Seat Depth: | 17¼ |
| Seat Width: | 19¾ | Ship Weight: | 34 Ⓢ |
| Back Width: | 19¾ | Cube: | 4.8 |
| Back Height: | 19⅞ | Weight Rating: | 250 lbs. |

PRICE CODE

Fabric **\$367**

NOTES: Comfortable and breathable mesh back. Black fabric seat. Sturdy black frame. Height-adjustable arms. **HON 5-Year Limited Warranty.**

HON Recommendation: HVL551.VB10 - List Price \$367

HOW TO SPECIFY

| | |
|-----------------------------------|---|
| <p>Select Model Number</p> | <p>Select Fabric</p> <p>VA10 Black Fabric Specify for model HVL521 only</p> <p>VB10 Black Fabric Specify for model HVL551 only</p> <p>ES10 Black Fabric Specify for model HVL525 only</p> |
|-----------------------------------|---|

H V L 5 2 1 .

V A 1 0



NESTING CHAIRS

HVL302

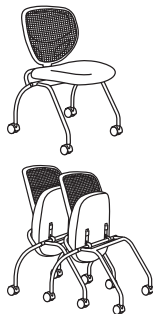

MESH BACK

Upholstered Seat
Casters
Armless

DIMENSIONS

| | | | |
|-------------|-----|------------------------|-------------|
| Depth: | 22 | Back Height: | 17 |
| Width: | 21½ | Seat to Floor Height: | 18¾ |
| Height: | 32½ | Usable Seat Depth: | 17¾ |
| Seat Depth: | 17¾ | Ship Weight (armless): | 43 Ⓢ |
| Seat Width: | 19¼ | Cube (armless): | 7.2 |
| Back Width: | 18¾ | Weight Rating: | 250 lbs. |

PRICE CODE

| | |
|--------------------|-----------------|
| Mesh | |
| Per Carton | \$589 |
| Single Unit | \$294.50 |

NOTES: Comfortable and breathable mesh back. Black sandwich fabric seat. Black frame. Ships two per carton. **HON 5-Year Limited Warranty.**

Ⓢ Mesh Nesting Chairs are ordered and shipped two (2) chairs per carton. Pricing shown is per carton. Each set of two (one carton), must have the same fabric/frame color. Ordering 2 of any model will result in 2 cartons being shipped, giving you 4 chairs.

HON Recommendation: HVL302.MM10.T - List Price \$589

HVL303



SANDWICH MESH BACK AND SEAT

Upholstered Seat and Back
Casters
Arms

DIMENSIONS

| | | | |
|-------------|-----|-----------------------|-------------|
| Depth: | 23¾ | Back Height: | 16 |
| Width: | 23¾ | Seat to Floor Height: | 19¼ |
| Height: | 33½ | Usable Seat Depth: | 18½ |
| Seat Depth: | 18½ | Ship Weight: | 27 Ⓢ |
| Seat Width: | 19½ | Cube: | 2.1 |
| Back Width: | 19½ | Weight Rating: | 250 lbs. |

LIST PRICE

\$233

NOTES: Seat and back upholstered in comfortable and breathable black sandwich mesh. Specify Black (T) or Silver (X) frame. Ships one per carton. **HON 5-Year Limited Warranty.**

HON Recommendation: HVL303.MM10.T - List Price \$233

HOW TO SPECIFY

| | | |
|--|---|---|
| <p>Select Model Number</p> <p>H V L 3 0 2 .</p> | <p>Select Fabric</p> <p>MM10 Black Sandwich Mesh Fabric (only)</p> <p>M M 1 0 .</p> | <p>Select Frame</p> <p>T Black X Silver <i>Not specified for model HVL302</i></p> <p>T</p> |
|--|---|---|



TASK CHAIRS

HVL220

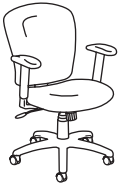

TASK MID-BACK

Pneumatic
Swivel
Tilt
Tilt Tension
Tilt Lock
Height-adjustable Arms
Functions: **A, E, F, K, L, Q**
(Function Key on pages 18-19)

DIMENSIONS

| | | | |
|--------------|-----|-----------------------|-------------|
| Depth: | 34½ | Arm Width: | 17¾ |
| Width: | 26¾ | Seat to Floor Height: | 17½-21¼ |
| Height: | 41 | Usable Seat Depth: | 16¾ |
| Seat Depth: | 16¾ | Ship Weight: | 35 Ⓢ |
| Seat Width: | 20 | Cube: | 3.7 |
| Back Width: | 20¼ | Weight Rating: | 250 lbs. |
| Back Height: | 22½ | | |

PRICE CODE

Fabric **\$269**

NOTES: Black fabric. Sturdy textured black frame. Height-adjustable arms. **HON 5-Year Limited Warranty.**

HON Recommendation: HVL220.VA10 - List Price \$269

HOW TO SPECIFY

Select Model Number

Select Fabric

VA10 Black Fabric

H V L 2 2 0 .

V A 1 0

WORKPLACE TOOLS

Ergonomic Solutions

OPEN MARKET



Icon Legend on page 17

HVL981



RECTANGLE WOBBLE BOARD

Anti-Fatigue Mat

DIMENSIONS

Depth: 18
Width: 22¼
Height: 3

Ship Weight: 10.0 Ⓢ
Cube: 0.9
Weight Rating: 250 lbs.

LIST PRICE

\$223

NOTES: HON 5-Year Limited Warranty.

ⓘ Available in Black (T) finish ONLY.

SPECIFYING EXAMPLE: HVL981.T

HVL982



ROUND WOBBLE BOARD

Anti-Fatigue Mat

DIMENSIONS

Depth: 18½
Width: 18½
Height: 2½

Ship Weight: 5.8 Ⓢ
Cube: 0.6
Weight Rating: 250 lbs.

LIST PRICE

\$192

NOTES: HON 5-Year Limited Warranty.

ⓘ Available in Black (T) finish ONLY.

SPECIFYING EXAMPLE: HVL982.T

HBEAFM1

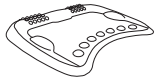

ANTI-FATIGUE MAT

Ergonomic

DIMENSIONS

Depth: 25
Width: 29⅞
Height: 2¾

Ship Weight: 7.0
Cube: 1.4

LIST PRICE

\$178

NOTES: HON 5-Year Limited Warranty.

ⓘ Available in Black ONLY. No specification needed.

SPECIFYING EXAMPLE: HBEAFM1

HBAFM2036

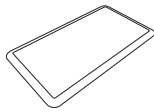

ANTI-FATIGUE MAT

Rectangle

DIMENSIONS

Depth: 20
Width: 36
Height: ¾

Ship Weight: 5.4
Cube: 0.4

LIST PRICE

\$81

NOTES: HON 5-Year Limited Warranty.

ⓘ Available in Black ONLY. No specification needed.

SPECIFYING EXAMPLE: HBAFM2036

HVL991

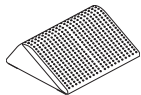

FOOTREST

Anti-Slip Cover

DIMENSIONS

Depth: 13¾
Width: 16
Height: 5½

Ship Weight: 7.0 Ⓢ
Cube: 0.9
Weight Rating: 250 lbs.

LIST PRICE

\$66

NOTES: HON 5-Year Limited Warranty.

ⓘ Available in Black (T) finish ONLY.

SPECIFYING EXAMPLE: HVL991.T

HOW TO SPECIFY

| | |
|---|--|
| <p>Select Model Number</p> <p>H V L 9 8 1 .</p> | <p>Select Finish</p> <p>T Black</p> <p>T</p> |
|---|--|

WORKPLACE TOOLS

Chair Mats

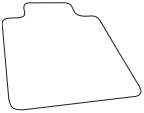
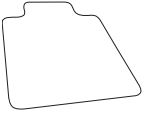
| | DESCRIPTION | MODEL | SHIP WEIGHT | CUBE | LIST PRICE |
|---|---|------------------|-------------|------|--------------|
|  | Lipped Chair Mat with Studs 60"W x 46"D 48"W x 36"D NOTES: Clear finish only. Available in 60"W x 46"D and 48"W x 36"D sizes. Features rectangle and lipped shapes. Available with studs for carpet and without studs for hard-surface floors. Ships rolled. HON 5-Year Limited Warranty. ⓘ Clear finish only. No specification needed. | HCM4660LS | 13.9 | 1.0 | \$118 |
| | | HCM3648LS | 8.8 | 0.6 | \$71 |
|  | Lipped Chair Mat without Studs 60"W x 46"D 48"W x 36"D NOTES: Clear finish only. Available in 60"W x 46"D and 48"W x 36"D sizes. Features rectangle and lipped shapes. Available with studs for carpet and without studs for hard-surface floors. Ships rolled. HON 5-Year Limited Warranty. ⓘ Clear finish only. No specification needed. | HCM4660LN | 13.2 | 0.5 | \$118 |
| | | HCM3648LN | 8.3 | 0.3 | \$71 |

HOW TO SPECIFY

Select Model Number

H C M 4 6 6 0 L S

CROSS REFERENCE INDEX

| MODEL | PAGE | MODEL | PAGE | MODEL | PAGE | MODEL | PAGE |
|-------|------|------------|--------------------|-----------|---------------|----------|----------|
| H2071 | 125 | H5795 | 300, 301, 304, 305 | HFLCO1 | 109 | HHCB50 | 297 |
| H2072 | 125 | H5901 | 59 | HFLCO1DF | 110 | HHCG11 | 279 |
| H2073 | 125 | H5902 | 59 | HFLCO1T | 109 | HHCG11DF | 280 |
| H2091 | 228 | H5903 | 59 | HFLCO1TDF | 111 | HHCG21 | 279 |
| H2092 | 228 | H5905 | 60 | HFLGANG | 95, 99 | HHCG21DF | 280 |
| H2093 | 228 | H5991 | 60 | HFLMC1 | 93 | HHCG50 | 279 |
| H2095 | 228 | H5995 | 60 | HFLMC1DF | 98 | HHCG50DF | 281 |
| H2111 | 167 | H6541 | 312 | HFLMC1S | 96 | HHCGB21 | 282 |
| H2112 | 167 | H6545 | 312 | HFLMC1SDF | 101 | HHCGB31 | 282 |
| H2141 | 168 | H6551 | 315 | HFLML1 | 93 | HHCGBR | 284 |
| H2142 | 168 | H6552 | 315 | HFLML1DF | 98 | HHCGBRCH | 284 |
| H2143 | 168 | H7803 | 319 | HFLMR1 | 93 | HHCP1 | 279 |
| H2144 | 168 | H7808 | 319 | HFLMR1DF | 99 | HHCP1DF | 281 |
| H2145 | 168 | H7823 | 320 | HFLRC1 | 92 | HHCT01 | 297 |
| H2146 | 168 | H7828 | 320 | HFLRC1DF | 97 | HHCT02 | 297 |
| H2164 | 46 | H7895 | 319 | HFLRC1S | 96 | HHCT020 | 296 |
| H2165 | 46 | HBAFM2036 | 328 | HFLRC1SDF | 101 | HHCT024 | 296 |
| H2191 | 231 | HBEAFM1 | 222, 328 | HFLSC1 | 92 | HHCT048 | 296 |
| H2192 | 231 | HBMPT4824P | 41 | HFLSC1DF | 97 | HHCT12 | 297 |
| H2194 | 231 | HBMPT4824X | 41 | HFLSC1S | 96 | HHCTC | 283 |
| H2281 | 175 | HBMPT48MOD | 41 | HFLSC1SDF | 101 | HHCTL4 | 283 |
| H2282 | 176 | HBMPT6024P | 41 | HFLSO1 | 95 | HHCTRT | 283 |
| H2283 | 175 | HBMPT6024X | 41 | HFLWI45 | 94 | HHCTS | 283 |
| H2284 | 176 | HBMPT60MOD | 41 | HFLWI45DF | 100 | HI2AAA | 157 |
| H2285 | 177 | HBMPT7224P | 41 | HFLWO45 | 94 | HI2ATA | 157 |
| H2403 | 309 | HBMPT7224X | 41 | HFLWO45DF | 100 | HI2FHA | 157 |
| H4001 | 262 | HBMPT72MOD | 41 | HFLYO1 | 109 | HIAAA | 152 |
| H4002 | 262 | HCAT1MM | 70 | HFLYO1DF | 110 | HIATA | 152 |
| H4003 | 262 | HCG6 | 52 | HFLYO1T | 109 | HIB50 | 160 |
| H4008 | 262 | HCG6DF | 52 | HFLYO1TDF | 111 | HICS7 | 161 |
| H4031 | 142 | HCM3648LN | 329 | HFSS7 | 104 | HICS7DF | 163 |
| H4033 | 142 | HCM3648LS | 329 | HFSS74L | 105 | HIEH1 | 150 |
| H4039 | 142 | HCM4660LN | 329 | HFSS74LDF | 106 | HIEH2 | 150 |
| H4041 | 206 | HCM4660LS | 329 | HFTB17N | 116 | HIEH3 | 150 |
| H4043 | 206 | HCT1MM | 69 | HFTLA2460 | 115 | HIFHA | 84, 152 |
| H4048 | 206 | HCW1 | 51 | HFTLA3372 | 115 | HIGB1 | 161, 163 |
| H4049 | 206 | HDAA01 | 65 | HFTLA3384 | 115 | HIGCL | 159 |
| H4069 | 214 | HDAC01 | 65 | HFTLA3396 | 115 | HIGS6 | 161 |
| H4071 | 210 | HDAL02 | 65 | HFTLC2460 | 115 | HIGS6DF | 162 |
| H4073 | 210 | HFAA01 | 171 | HFTLC3372 | 115 | HIHC | 160 |
| H4075 | 211 | HF AFL1 | 121 | HFTLC3384 | 115 | HIL2L | 159 |
| H4077 | 211 | HFAL02 | 171 | HFTLC3396 | 115 | HILMBR | 157 |
| H4079 | 214 | HFALA1 | 121 | HFTLD26 | 119 | HILTL | 159 |
| H4091 | 212 | HFAS03 | 171 | HFTLD30 | 115 | HIPAA | 84, 152 |
| H4093 | 212 | HFASH1 | 121 | HFTLD36 | 115 | HISB6 | 161 |
| H4095 | 213 | HF CG6 | 105 | HFTLR12 | 119 | HISB6DF | 162 |
| H4097 | 213 | HF CG6DF | 106 | HFTLS24 | 119 | HITL1 | 148 |
| H4099 | 214 | HFCL1 | 105 | HFTLS30 | 115 | HITL2 | 148 |
| H5001 | 217 | HFCL1DF | 106 | HFTLS36 | 115 | HITL3 | 148 |
| H5002 | 217 | HFDB17B | 116 | HFTLW45 | 119 | HITLM | 155 |
| H5003 | 217 | HFDB17N | 116 | HFTPTL18 | 118 | HITLMKD | 156 |
| H5021 | 221 | HFDB29A | 116 | HFTTAL14 | 120, 135, 140 | HITS5 | 151 |
| H5022 | 221 | HFDB29AN | 116 | HFXB17B | 116 | HITSM | 155 |
| H5023 | 221 | HFDB29B | 116 | HFXB29A | 116 | HIWM1 | 149 |
| H5701 | 300 | HFDB42A | 117 | HFXB29AN | 116 | HIWM2 | 149 |
| H5703 | 300 | HFDB42AF | 117 | HFXB29B | 116 | HIWM3 | 149 |
| H5705 | 300 | HFDB42AF72 | 117 | HFXB42A | 117 | HIWM8 | 151 |
| H5711 | 301 | HFDB42AF84 | 117 | HFXB42AN | 117 | HIWMM | 155 |
| H5713 | 301 | HFDB42AF96 | 117 | HFXB42B | 117 | HIWMMKD | 156 |
| H5715 | 301 | HFDB42AFN | 117 | HGDK3-F | 257 | HL1SL | 85 |
| H5721 | 304 | HFDB42AN | 117 | HGRMTAC | 122, 135, 140 | HL2DARM | 84 |
| H5723 | 304 | HFDB42B | 117 | HGRMTAC2 | 122, 135, 140 | HL2SL | 85 |
| H5725 | 304 | HFDB42BF | 117 | HGRMTDATA | 122 | HL3SL | 85 |
| H5731 | 305 | HFL45O | 95 | HGRMTUSB2 | 122, 135, 140 | HL4DARM | 84 |
| H5733 | 305 | HFLCC1 | 94 | HHB02 | 295 | HLEU | 79 |
| H5735 | 305 | HFLCC1DF | 100 | HHB03 | 295 | HLEUBT | 82 |

CROSS REFERENCE INDEX

| MODEL | PAGE | MODEL | PAGE | MODEL | PAGE | MODEL | PAGE |
|-----------|------|-------------|------|-------------|--------------|--------------|----------|
| HLMSSHHR | 84 | HNIU | 203 | HSS4L-18B | 257 | HVL585 | 73 |
| HLOCC1 | 86 | HN6 | 204 | HSSA-WB1618 | 257 | HVL601 | 323 |
| HLOCC2 | 86 | HN7 | 204 | HSSCL-14A | 258 | HVL604 | 289 |
| HLOCC3 | 86 | HNATA | 204 | HSSCL-16B | 258 | HVL605 | 289 |
| HLTMM | 81 | HNFA | 204 | HSSCL-18B | 258 | HVL606 | 252 |
| HLTP | 81 | HPN1 | 225 | HSSST-18B | 259 | HVL616 | 252 |
| HLTSM | 83 | HPN2 | 225 | HSSTK-18B | 259 | HVL641 | 53 |
| HLTSP | 83 | HPWRMOD2UWM | 122 | HTPWGRGOM1 | 86, 135, 140 | HVL643 | 53 |
| HLTSU | 83 | HPWRMOD3UWM | 122 | HUCART | 214 | HVL653 | 324 |
| HLTU | 81 | HQTMM | 243 | HVL102 | 288 | HVL685 | 289 |
| HLWM | 80 | HQTSM | 243 | HVL103 | 288 | HVL691 | 55 |
| HLWMBT | 82 | HRIP | 237 | HVL105 | 321 | HVL693 | 55 |
| HLWU | 80 | HRIS | 237 | HVL108 | 74 | HVL701 | 306 |
| HLWUBT | 82 | HR1W | 237 | HVL131 | 321 | HVL702 | 306 |
| HMAGANG | 41 | HR5P | 238 | HVL151 | 321 | HVL705 | 306 |
| HMG1 | 187 | HR5S | 238 | HVL161 | 322 | HVL712 | 306 |
| HMG2 | 187 | HR5W | 238 | HVL171 | 322 | HVL721 | 88 |
| HMG3 | 188 | HRAAP | 239 | HVL205 | 290 | HVL844 | 286 |
| HMG4 | 188 | HRFAP | 239 | HVL206 | 290 | HVL852 | 286 |
| HMG5 | 188 | HSB50 | 36 | HVL210 | 290 | HVL853 | 286 |
| HMG7 | 188 | HSB50DF | 38 | HVL215 | 290 | HVL871 | 54 |
| HMG11 | 194 | HSCS1 | 35 | HVL220 | 327 | HVL872 | 54 |
| HMG12 | 194 | HSCS1DF | 37 | HVL281 | 198 | HVL873 | 54 |
| HMH01 | 43 | HSCS2 | 36 | HVL282 | 198 | HVL887 | 71 |
| HMH02 | 43 | HSCS2DF | 38 | HVL283 | 198 | HVL888 | 71 |
| HML1S | 132 | HSGANG | 38 | HVL289 | 198 | HVL891 | 127 |
| HML1SDF | 136 | HSGS6 | 35 | HVL302 | 326 | HVL892 | 126 |
| HML2S | 132 | HSGS6DF | 37 | HVL303 | 326 | HVL893 | 126 |
| HML2SDF | 137 | HSLV2DAP | 274 | HVL304 | 40 | HVL894 | 126 |
| HML2ST | 134 | HSLV4DAP | 274 | HVL314 | 40 | HVL895 | 126 |
| HML2STDF | 139 | HSLVFAP | 274 | HVL402 | 322 | HVL951 | 285 |
| HML3S | 133 | HSLVLMBR | 274 | HVL443 | 324 | HVL981 | 328 |
| HML3SDF | 138 | HSLVSMM | 267 | HVL508 | 164 | HVL982 | 328 |
| HML8851 | 72 | HSLVSMMS | 271 | HVL511 | 287 | HVL991 | 222, 328 |
| HML8852 | 72 | HSLVSMR | 268 | HVL515 | 287 | HVL995 | 290 |
| HMN1 | 191 | HSLVSMRS | 272 | HVL518 | 164 | HVLPERCH | 222 |
| HMN2 | 191 | HSLVSMU | 269 | HVL521 | 325 | HVPTO2424L16 | 218 |
| HMNT1 | 197 | HSLVSMUS | 273 | HVL525 | 325 | HVPTO2424L21 | 218 |
| HMNT2 | 197 | HSLVTMM | 267 | HVL528 | 164 | HVPTO2448L16 | 218 |
| HMS1 | 183 | HSLVTMMKD | 270 | HVL530 | 232 | HWGN1 | 247 |
| HMS2 | 183 | HSLVTMMS | 271 | HVL531 | 232 | HWGN1B | 249 |
| HMSCART | 183 | HSLVTMR | 268 | HVL532 | 232 | HWGN2 | 247 |
| HMSFLTGLD | 184 | HSLVTMRKD | 270 | HVL534 | 233 | HWGN2B | 249 |
| HMSGANG | 184 | HSLVTMRS | 272 | HVL536 | 233 | HWGN3 | 247 |
| HMSGLD | 184 | HSLVTMU | 269 | HVL537 | 233 | HWGN3B | 249 |
| HMSSTLGLD | 184 | HSLVTMUKD | 270 | HVL538 | 164 | HWGN4 | 248 |
| HMT1 | 181 | HSLVTMUS | 273 | HVL539 | 233 | HWGN4B | 250 |
| HMT5 | 181 | HSS4L-06A | 256 | HVL541 | 87 | HWGN5 | 248 |
| HMTS01 | 39 | HSS4L-12A | 256 | HVL551 | 325 | HWGN5B | 250 |
| HMTS11 | 39 | HSS4L-14A | 256 | HVL581 | 73 | HWGNC | 251 |
| HNI | 203 | HSS4L-16B | 257 | HVL582 | 73 | HWGNT | 251 |

NOTES

NOTES

INFORMATION ON ORDERING PARTS

When parts are needed to repair HON products, the following guidelines should be followed to expedite the process.

1. Contact the Parts Department at **Consumer Number: 1-800-336-8398**. They will assist you with your order and answer any questions on parts.
2. There are no discounts applied to parts. Pricing quoted is the net value. Parts pricing is subject to change without notice.
3. The minimum order for a part not covered by warranty is \$7.50 (includes shipping and handling).
4. Parts may be paid for with an approved credit card. Approved Cards: MasterCard, VISA and American Express.
5. Payment terms for invoiced parts are Net 30 days.
6. Due to short lead times on parts, no changes will be accepted after the order has been placed.
7. When placing a **warranty** parts order:

If the product is under warranty, the product serial number must be provided. Most finished goods products have a serial number placed on them at the factory. The label containing the serial number is located:

Tables and Stands — underside of the top

Table Trucks — underside of side rail

Seating — underside of the seat

NOTE: Removal of the serial number tag from the product voids the warranty.

An important note regarding Product Serial Numbers:

HON tables and chairs are tagged with a serial number. This number helps us identify *when and where your product was made*, and to identify and correct the root causes for the problem. **NEITHER THE DEALER NOR THE CONSUMER SHOULD REMOVE THIS TAG UNDER ANY CIRCUMSTANCES.** To do so immediately voids your Warranty coverage for that particular item *and prevents us from further identifying it*. Instead, please transcribe the number and call your Dealer.