

Reconnaissance Geologic Map of the Egli Rim 7.5' Quadrangle and Vicinity Lake County, Oregon

2013

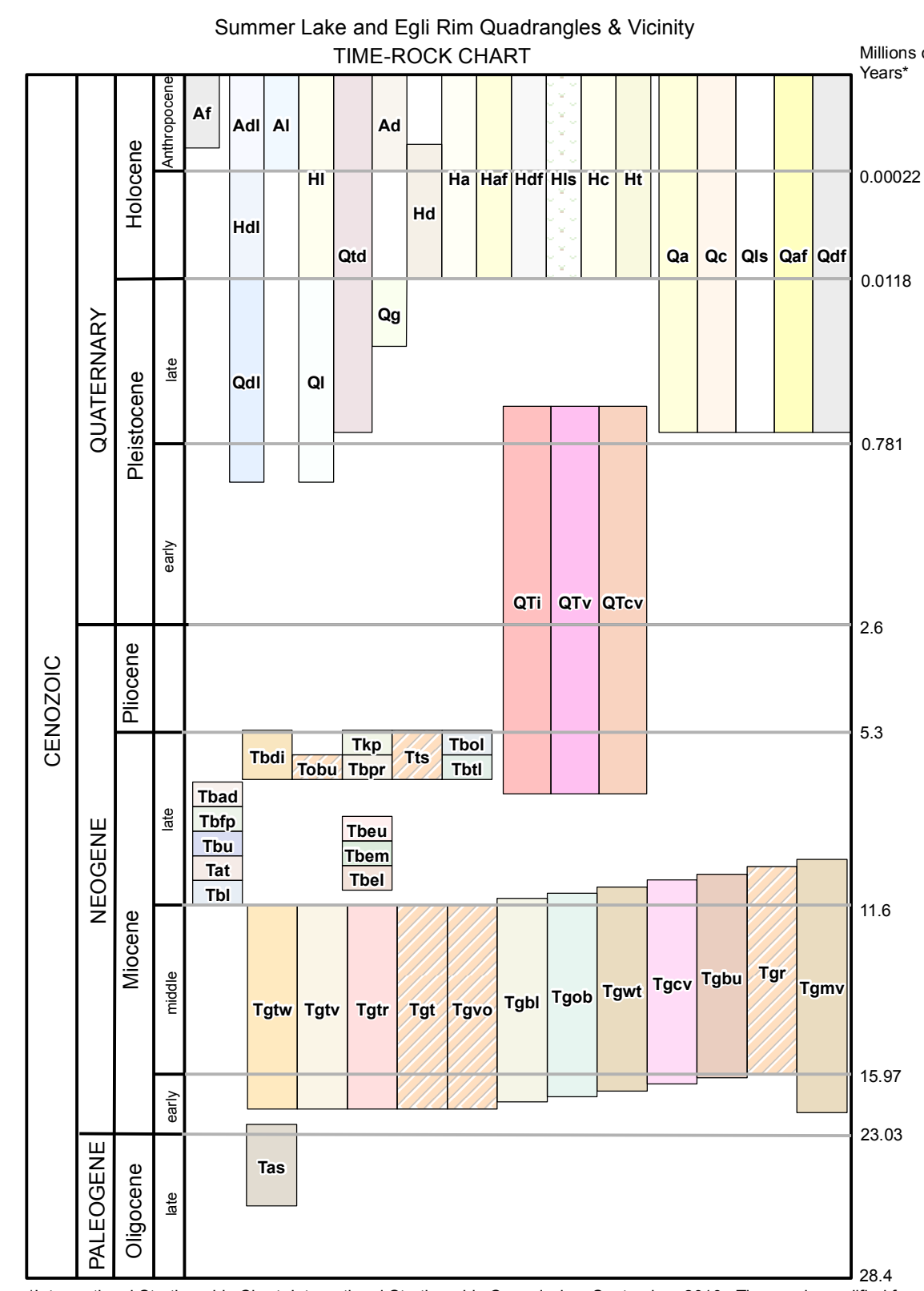
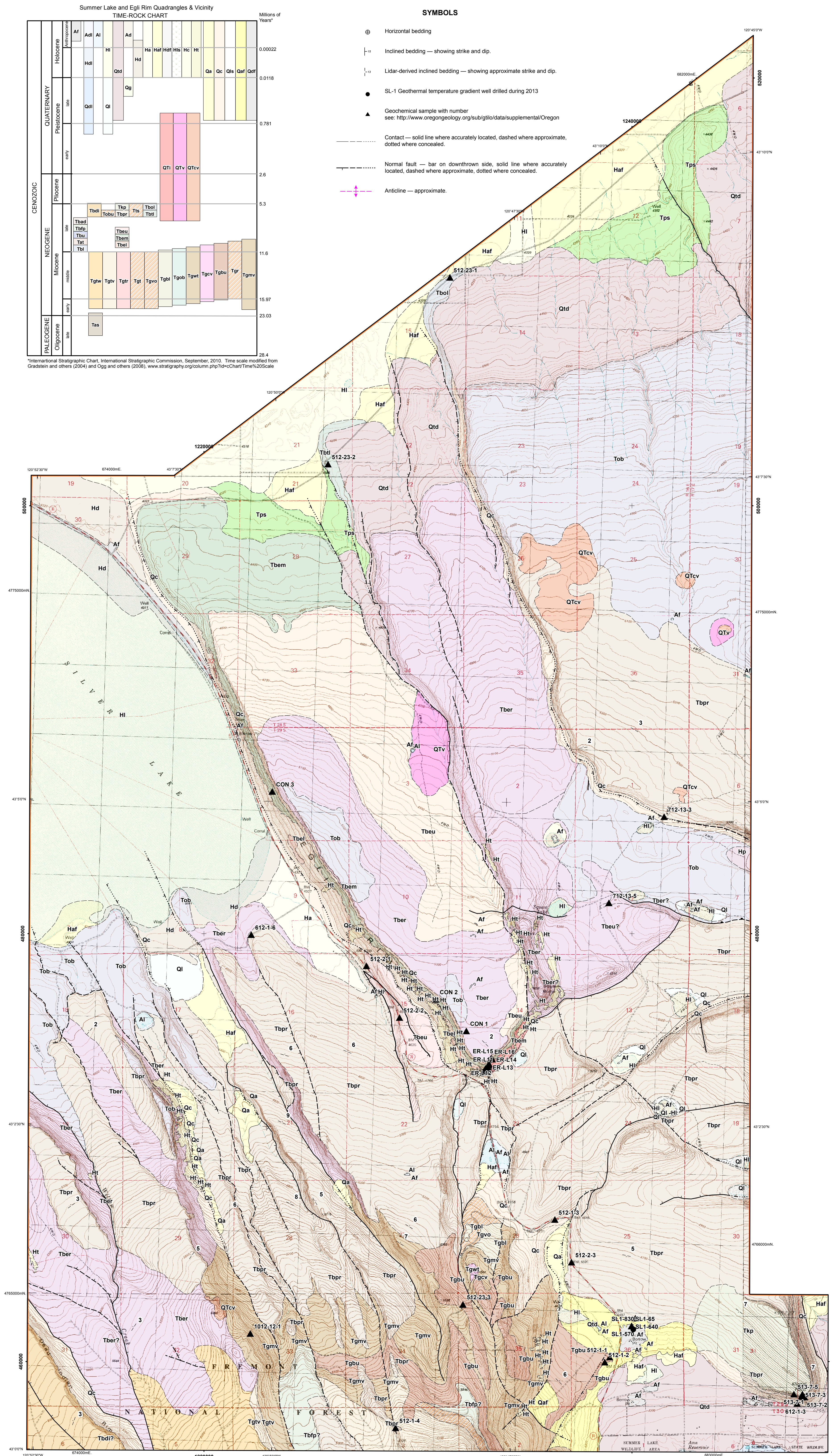

- ### SYMBOLS
- ⊕ Horizontal bedding
 - ⊖ Inclined bedding — showing strike and dip.
 - ⊖ Lidar-derived inclined bedding — showing approximate strike and dip.
 - SL-1 Geothermal temperature gradient well drilled during 2013
 - ▲ Geochemical sample with number see: <http://www.oregongeology.org/sub/iglo/data/supplemental/Oregon>
 - Contact — solid line where accurately located, dashed where approximate, dotted where concealed.
 - Normal fault — bar on downthrown side, solid line where accurately located, dashed where approximate, dotted where concealed.
 - ⊕ Anticline — approximate.

- ### EXPLANATION OF MAP UNITS
- Adf Manmade fill, construction material, and disturbed ground (Anthropocene)
 - Adl Delta deposits (Anthropocene)
 - Al Lake deposits (Holocene)
 - Ad Sand (Anthropocene)
 - Hi Lake deposits (Holocene)
 - Ha Alluvium (Holocene)
 - Hc Colluvium (Holocene)
 - Ht Talus deposits (Holocene)
 - Hls Landslide deposits (Holocene)
 - Haf Alluvial fan deposits (Holocene)
 - Hdf Debris flow deposits (Holocene)
 - Hd Delta deposits (Holocene)
 - Qtd Terrace deposits (Late Pleistocene and Holocene)
 - Qa Alluvium (Late Pleistocene or Holocene)
 - Qc Colluvium (Late Pleistocene or Holocene)
 - Qls Landslides (Late Pleistocene or Holocene)
 - Qaf Alluvial fan deposits (Late Pleistocene or Holocene)
 - Qdf Debris flow deposits (Late Pleistocene or Holocene)
 - Qg Glacial deposits (Late Pleistocene)
 - Qdl Delta deposits (Pleistocene)
 - Ql Lake deposits (Pleistocene)

- ### Quaternary and late Tertiary volcanic rocks of the Basin and Range Province
- QTV Vent facies (Quaternary or Neogene)
 - QTCV Vent facies, cinders (Quaternary and/or Neogene)
- Picture Rock Basalt (upper Miocene and Pliocene; reverse polarity)
- Tkp Basalt of Kippel Point (upper Miocene or Pliocene, reverse polarity)
 - Tbs1 Basalt of Section 1, T. 29 S., R. 16 E. (upper Miocene or Pliocene)
 - Tbol Basalt of Old Lake Road (upper Miocene or Pliocene)
 - Tbd Basalt of Dead Indian Rim (upper Miocene or Pliocene)
 - Tts Tuff and sedimentary rock interlayered with Picture Rock Basalt (upper Miocene and Pliocene)
 - Tbu Olivine basalt of Squaw Lake (upper Miocene or Pliocene)
 - Tbp Basalt of Picture Rock Pass (upper Miocene, reverse polarity)
 - Tbt Basalt of Thorn Lake (upper Miocene)
 - Tlu Andesite (upper Miocene)

- ### Local (?) unconformity
- #### Egli Rim Section of the Picture Rock Basalt
- Tber Diaktylaxitic basalt of Egli Rim (upper Miocene; reverse polarity)
 - Tbeu Upper lava flows; Flows 15 and 16.
 - Tbem Middle lava flows — flows 5 through 14
 - Tbel Lower lava flows, include olivine phryic flows 1 through 4.

- ### Winter Ridge Area
- Twad Basalt of Duncan Creek (upper Miocene)
 - Twdp Glomeroporphyritic olivine basalt of Fremont Point (upper Miocene)
 - Tbu Upper basalt (upper Miocene)
 - Tat Andesite of Travis, 1977 (upper Miocene)
 - Tzu Lower basalt (middle or upper Miocene)

- ### Local (?) unconformity
- #### Grizzly Volcanic Center
- Tgmw Mixed volcanic rocks, including volcanoclastic sedimentary rocks and pyroclastic rocks (Miocene)
 - Tgr Rhyolite (Miocene)
 - Tgu Basalt, upper (Miocene)
 - Tgv Younger cinders and vent facies (Miocene)
 - Tgw White Rock tuff (Miocene)
 - Tgob Obsidian breccia of Travis (1977) (Miocene)
 - Tgl Basalt, lower (Miocene)
 - Tgvo Older vent facies (Miocene)
 - Tgf Trachydacitic orthopyroxene ash tuff (lower or middle Miocene)
 - Tgrh Rheomorphic block and ash tuff (lower or middle Miocene)
 - Tgv Trachydacitic vitrophyre (lower or middle Miocene)
 - Tgwa Trachydacite of Winter Ridge (lower or middle Miocene)

- ### Oligocene or Miocene Volcanic Rocks
- Tas Andesite of Summer Lake (Upper Oligocene or lower Miocene)

- ### Neogene or Quaternary Intrusive Rocks
- Qli Intrusive diaktylaxitic olivine basalt (late Miocene, Pliocene, or Pleistocene)

NOTICE

This map cannot serve as a substitute for site-specific investigations by qualified practitioners. Site-specific data may give results that differ from those shown on the maps. The views and conclusions contained in this document are those of the authors and should not be interpreted as necessarily representing the official policies, either expressed or implied, of the U.S. government.

Base map by U.S. Geological Survey 1982
Control by USGS and NGS/NGAA
Topography compiled from aerial photographs taken 1976.
Field checked 1977. Map edited 1981.
Oregon State Plane South (Lambert conformal conic projection)
Meridian datum: National geodetic central meridian of 1929
Horizontal datum: 1927 North American datum
1000 meter universal transverse mercator, zone 10
Reprojected to Oregon Lambert
Horizontal datum: 1983 NAD83
Control: NAD83 and NAD83 benchmark points
Oregon State Plane South
20,000 foot state grid scale, 2" 30" grid scale
2012 magnetic north declination: 55 degrees east
Software used: ESRI ArcMap 10.1, Adobe Acrobat 9 Pro

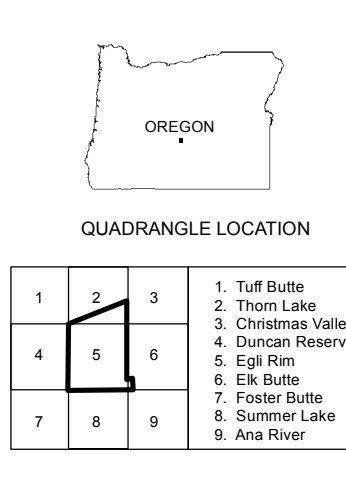
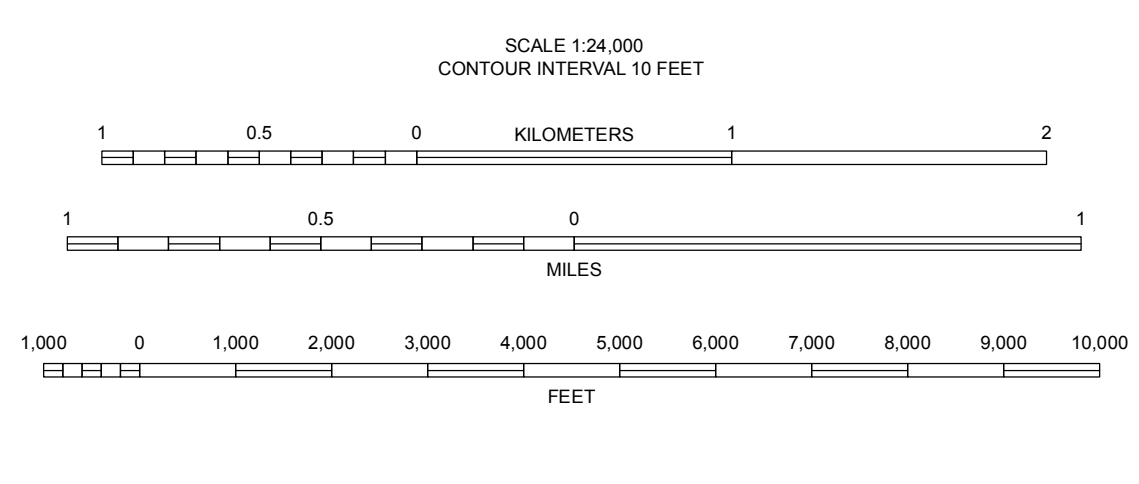
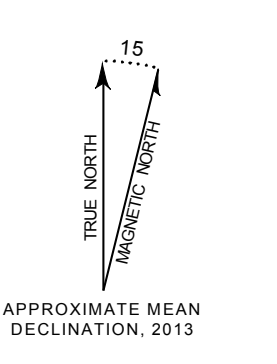

Geology by Thomas J. Wiley,
Oregon Department of Geology
and Mineral Industries, and Sean
M. Gallagher, Portland State Univ.
Field work conducted in 2012, 2013

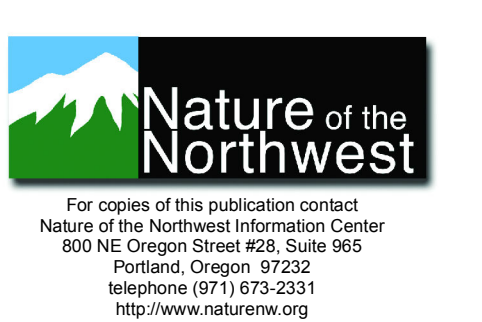

Map Unit Explanation for the Reconnaissance Geologic Map of the Egli Rim Quadrangle and Vicinity, Lake County, Oregon, Plate 2a

INTRODUCTION

This text of Explanation of Map Units accompanies Plate 2a, Reconnaissance Geologic Map of the Egli Rim Quadrangle and Vicinity, Lake County, Oregon. Figure 1 shows the location of the quadrangle. The geologic map also covers parts of the adjacent Thorn Lake and Elk Buttes USGS 7.5-minute quadrangles. The Oregon Department of Geology and Mineral Industries (DOGAMI) prepared the map to partially satisfy the Scope of Work, Task 3 for the US Energy Department's (USDoE) Geothermal Technologies Program through the Arizona Geological Survey for new geothermal data collection (expanding Task 2.4 of the project objectives). The purpose of this geologic mapping was to characterize the geology around the location of drilling the thermal gradient well ARRA SL-1 (Figure 1).

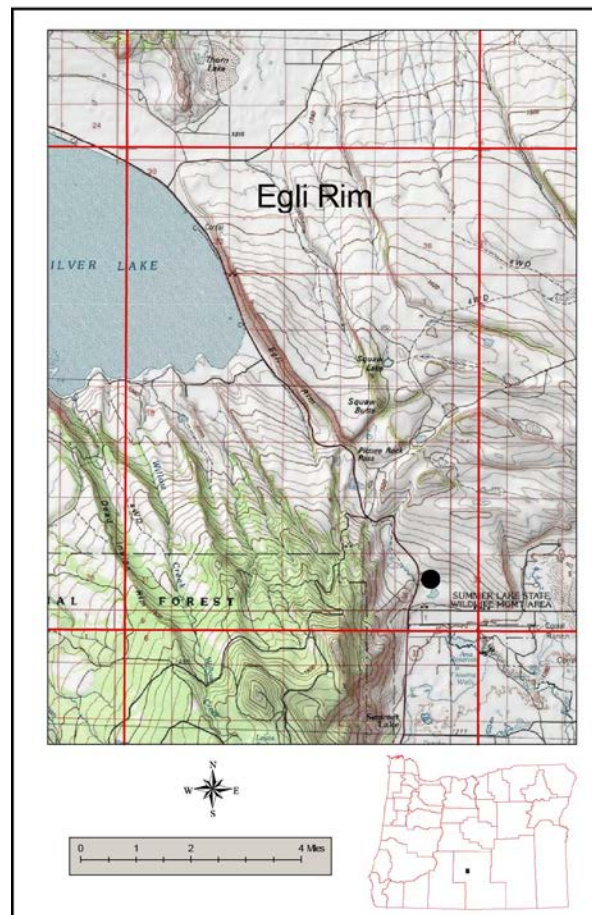

Figure 1. Location map. Showing location of the Egli Rim 7.5-minute quadrangle (outlined in red). The black dot is the location of drilling the thermal gradient well ARRA SL-1

The Egli Rim quadrangle is located in south-central Oregon, just south of the boundary between the Basin and Range Province (to which it is loosely assigned) and the High Lava Plains Province (that lies to the north). Deformation in the Basin and Range Province since middle Miocene time has broadly warped local basement into north-northwest- to north-northeast-trending folds underlain by middle Miocene to Oligocene volcanic, pyroclastic, and sedimentary rocks. The Egli Rim quadrangle, topography is dominated by features resulting from complex folding, extension, and normal faulting. Three features that stand out are Egli Rim (a thousand-foot-high [300-meter high] fault scarp), the faulted anticline that plunges from the crest of Winter Ridge to the basin beneath Silver Lake, and the curved, nested system of normal faults that crop out between Klippel Point and Squaw Butte.

METHODOLOGY

Geologic data were collected using digital aerial photographs, USGS 10-m digital elevation models (DEMs), and partial 3 ft (1-m) lidar DEMs and were compiled by combining new mapping with published and unpublished data. Field data were converted into digital format using ESRI ArcGIS™ ArcMAP™ 10.1 GIS software by on-screen digitizing using georeferenced 1:24,000-scale DRG, 10-m DEMs, and a partial lidar DEM as base maps. Geologic interpretations were also aided by GIS analyses incorporating 2009 National Agriculture Imagery Program (NAIP) digital orthophotography. The mapped distribution of surficial deposits is derived in part from soils maps and descriptions published by the Natural Resource Conservation Service (NRCS) of the U.S. Department of Agriculture (NRCS website). Where possible lidar DEMs were used to modify the distribution of both bedrock and surficial geologic units at a maximum scale of 1:8,000. Open water bodies were digitized from 2009 NAIP air orthophotography and 1-m lidar DEMs if available. The geologic time scale used is the September 2010 version of the International Stratigraphic Commission's International Stratigraphic Chart (www.stratigraphy.org/column.php?id=Chart/Time%20Scale.pdf).

Mapping was supported by new and compiled X-ray fluorescence (XRF) chemical analyses of whole-rock samples, new and compiled radiometric age-date determinations, limited thin-section petrography, measurements of natural remnant magnetization (magnetic polarity), and strike and dip measurements of inclined bedding. Samples for whole-rock chemical analysis were prepared and analyzed by X-ray fluorescence (XRF) at the Department of Geosciences, Franklin and Marshall College, Lancaster, Pennsylvania. Analytical procedures for the Franklin and Marshall X-ray laboratory are described by Boyd and Mertzman (1987) and Mertzman (2000), and are available online at <http://www.fandm.edu/x7985>.

In this report, volcanic rocks with fine-grained (<1 mm [0.04 in] average crystal or particle size in the groundmass are described as having “coarse groundmass” if the average size is <1 mm (0.04 in) and they can be determined using the naked eye (>~0.5 mm [0.02 in]); as having “medium groundmass” if crystals of average size cannot be determined by eye, but can be distinguished using a hand lens (>~0.05 mm [0.02 in]); as having “fine groundmass” if crystals or grains of average size can only be determined using a microscope (or by hand lens recognition of phyllite-like sparkle or sheen in reflected light, indicating the presence of crystalline groundmass); or as having a “glassy groundmass” if the groundmass has (fresh), or originally had (altered), groundmass with the characteristics of glass (conchoidal fracture; sharp, transparent edges; vitreous luster; etc.). Mixtures of crystalline and glassy groundmass are described as intersertal; ratios of glass to crystalline materials may be indicated by textural terms including holocrystalline, hypocrySTALLINE, hyalophitic, and hyalopilitic. Microphenocrysts are defined as crystals larger than the overall groundmass and < 1 mm across (0.04 in).

EXPLANATION OF MAP UNITS

QUATERNARY SURFICIAL DEPOSITS

Late Cenozoic sedimentary and volcanic rocks in the Egli Rim area are locally mantled by a thin veneer of Pleistocene, Holocene, and Anthropocene surficial deposits (Map Plate 2a). The floors of valleys with interior drainage were inundated by expanding late Pleistocene lakes including Silver and Summer Lakes. These lakes left delta, fan-delta, beach, and nearshore deposits along their margins at several elevations. Surficial units within the project area are delineated on the basis of geomorphology as interpreted from a combination of field observations, 3-foot lidar DEMs, 2009 NAIP orthophotographs, and USGS 7.5' topographic maps.

ANTHROPOCENE SURFICIAL DEPOSITS

- Af** **Manmade fill, construction material, and disturbed ground (Anthropocene)** — Man-made deposits of mixed gravel, sand, clay, and other debris. Deposits mapped as modern fill and construction material include those that make up dams, road embankments, causeways and culvert fills, and mined or bulldozed land. These deposits are assigned an Anthropocene age on the basis of inclusion of man-made debris or artifacts, or geomorphic evidence indicating man-made surface modifications. Modern (post-1950) engineered fill is generally stable, but older uncontrolled fill may liquefy, spread, or slump during strong earthquake shaking. The unit is mapped on the basis of topographic features interpreted from 3-foot lidar DEMs, 2009 NAIP orthophotographs, and, locally, field observations
- Adl** **Delta deposits (Anthropocene)** — Unconsolidated sand, silt, and clay deposited in deltas and rivers at the margins of Summer Lake. Deposits may include lake, fan-delta, and fluvial facies. They are distinguished from lake bed deposits by the presence of meandering channels and channel fragments on aerial photographs. At

Summer Lake these deposits have been inundated by historic water levels up to elevations at least as high as 4051 feet

- Al Lake deposits (Anthropocene)** — Sand, silt, clay and evaporite deposited in lakes and ephemeral lakes. Includes gravel developed on beaches and in small deltas, and fan deltas. Distribution approximates the extent of lake bed deposits laid down in historic times
- Ad Sand (Anthropocene)** — Sand, silt, and occasional very fine gravel deposited in largely unvegetated dunes and fields. Probably includes unmapped dune deposits of Holocene age

HOLOCENE SURFICIAL DEPOSITS

- Hl Lake deposits (Holocene)** — Sand, silt, clay, and evaporite deposited in lakes and pluvial or ephemeral lakes. May include unmapped gravel deposits at beaches, small deltas, and fan deltas. May include lake deposits of Anthropocene age. In small, isolated, pluvial lake basins sediment appears to be bimodal, with marginal deposits at higher elevations surrounding light-colored deposits at lake centers. Note: The marginal deposits have been mapped as older (Unit Ql), perhaps related to a wetter climate, and the central deposits have been mapped as younger, related to more recent climate (this unit). The age/lithology relationships are undoubtedly more complicated
- Ha Alluvium (Holocene)** — Sand, gravel, silt, and clay deposited along streams and on valley floors. May locally include or be interlayered with colluvium and talus near the base of steep slopes and fault scarps. Holocene deposits are recognized where alluvium is deposited on, or incised into, late Pleistocene and Holocene lake beds
- Hc Colluvium (Holocene)** — Gravel, typically subangular to angular, and sand deposited in sheets and wedges along steep slopes. May include unmapped areas of talus, bedrock, landslides, and creep
- Ht Talus (Holocene)** — Boulder gravel, typically angular to subangular, deposited in sheets and wedges along steep slopes. May include unmapped areas of bedrock, colluvium, and landslides
- Hls Landslides (Holocene)** — Unconsolidated, chaotically mixed and deformed rock, colluvium, and soil deposited by landslides. Most have occurred along the eastern escarpment of Winter Ridge and other steep fault scarps in the area. Triggering mechanisms for landslides include heavy rainfall, earthquakes, extensive devegetation due to fire, or some combination thereof. Areas of existing landslide deposits should be considered at high risk for further slope movement

- Haf Alluvial fan deposits (Holocene)** — Unconsolidated gravel, sand, silt, clay, and woody debris deposited in alluvial fans. Alluvial fans accumulate below the mouths of steep source drainages. Rapidly moving debris flows, which pose hazards to life and property, may periodically be expected on alluvial fans that lie at the mouths of steep-sided, colluvium-filled canyons and upland drainages. The potential for inundation of fan areas by these flows is increased during episodes of intense rainfall that occur after soils have been saturated by fall and early winter rainfall and during downpours that are often associated with thunderstorms. Holocene deposits are recognized where alluvium is deposited on, or incised into, late Pleistocene and Holocene lake beds
- Hdf Debris fan deposits (Holocene)** — Unconsolidated gravel, sand, silt, clay, and woody debris deposited in debris fans. These deposits accumulate near the mouths of steep source drainages. Rapidly moving debris flows, which pose hazards to life and property, may periodically be expected on alluvial and debris fans that lie at the mouths of steep-sided, colluvium-filled canyons and upland drainages. The potential for inundation of fan areas by these flows is increased during episodes of intense rainfall that occur after soils have been saturated by fall and early winter rainfall and during downpours such as those that are often associated with thunderstorms. May include fan-delta deposits where debris entered Pleistocene lakes (e.g. fans along the west side of Summer Lake)
- Hd Sand (Holocene)** — Sand, silt, and occasional very fine gravel at least partially covered by vegetation. Distribution appears to be related to distribution of trees in the study area. Probably includes unmapped older bedrock and terrace deposits, and young dune deposits of Anthropocene age
- Hdl Delta deposits (Holocene)** — Deposits may include lake, fan-delta, and fluvial facies that can be distinguished from lake bed deposits by the presence of meandering channels and channel fragments on aerial photographs

QUATERNARY SURFICIAL DEPOSITS

- Qtd Terrace deposits (Late Pleistocene or Holocene)** — Unconsolidated gravel and sand, with subordinate amounts of silt and clay that form a series of parallel, concentric, beach terraces along the shores of Summer and Silver Lakes. Terraces occur ~6 to 115 m (20 to 378 ft) above the modern lakebed at 1264 m (~4147 ft) and formed during periods of equilibrium as lake level retreated. May merge with delta or fan-delta deposits. May include unmapped stream channel facies, particularly where such facies were deposited parallel to a shoreline. The deposits are typically very permeable and yield a few to a few hundred gallons of water per minute in wells. These deposits are locally used as a source of sand and gravel for aggregate. Lower terraces may be of Holocene age.

- Qa Alluvium (Late Pleistocene or Holocene)** — Unconsolidated gravel, sand, silt, and clay deposited along active stream channels and on adjoining floodplains. Alluvium is locally used as a source of sand and gravel for aggregate.
- Qc Talus and colluvial deposits (Late Pleistocene or Holocene)** — Unconsolidated boulder and cobble breccia with minor pebbles, sand, silt, and clay deposited in colluvial aprons and fans. Typically derived from bedrock located upslope and transported by mechanisms including rock fall, creep, small landslides, small debris flows, and other forms of down slope movement on steep slopes including fault scarps and flow fronts. This unit is often thickest where prisms of the material collect at the base of high fault scarps. Angular bedrock clasts and open pore space distinguish talus deposited by rock fall from other colluvium. Colluvium generally accumulates on slopes beneath rock outcrops. Locally divided to show:
- Qls Landslide deposits (Quaternary)** — Unconsolidated, chaotically mixed and deformed rock, colluvium, and soil deposited by landslides. Mapped landslide deposits cover parts of the eastern escarpment of Winter Ridge and other steep fault scarps in the area. Triggering mechanisms for landslides include heavy rainfall, earthquakes, extensive devegetation due to fire, or some combination thereof. Areas of existing landslide deposits should be considered at high risk for further slope movement
- Qaf Alluvial fan deposits (Late Pleistocene or Holocene)** — Unconsolidated gravel, sand, silt, clay, and woody debris deposited in alluvial fans. Alluvial fans accumulate below the mouths of steep source drainages. Rapidly moving debris flows, which pose hazards to life and property, may periodically be expected on alluvial fans that lie at the mouths of steep-sided, colluvium-filled canyons and upland drainages. The potential for inundation of fan areas by these flows is increased during episodes of intense rainfall that occur after soils have been saturated by fall and early winter rainfall and during downpours that are often associated with thunderstorms
- Qdf Debris fan deposits (Late Pleistocene or Holocene)** — Unconsolidated gravel, sand, silt, clay, and woody debris deposited in debris fans. These deposits accumulate near the mouths of steep source drainages. Rapidly moving debris flows, which pose hazards to life and property, may periodically be expected on alluvial and debris fans that lie at the mouths of steep-sided, colluvium-filled canyons and upland drainages. The potential for inundation of fan areas by these flows is increased during episodes of intense rainfall that occur after soils have been saturated by fall and early winter rainfall and during downpours such as those that are often associated with thunderstorms. May include fan delta deposits where debris entered Pleistocene lakes (e.g. fans along the west side of Summer Lake)

- Qg Glacial deposits (Late Pleistocene)** — Gravel, gravelly sand, and gravelly silt. Valleys at the northern end of Winter Ridge have U-shaped cross sections high in the drainage (above ~5200 ft elevation (1585 m) that transition downstream to trapezoidal or triangular cross sections typical of valleys formed by normal faulting and the formation of grabens or half grabens in young, hard, volcanic rock. Thin, very poorly exposed patches of unconsolidated, poorly sorted sediment and boulders in the upper valleys are tentatively interpreted as glacial till or lag rather than alluvium or colluvium. Deposits are interpreted to form thin, discontinuous layers on bedrock. Their extent is based largely on recognizing high elevation topography with broad valley floors, U-shaped valley cross section, lower than average slope, isolated boulders, and rounded valley heads in map view. The area covered by ice was likely more extensive than the deposits and the deposits may be more or less extensive than shown
- Qdl Delta deposits (Pleistocene)** — Sand, gravel, and mud deposited where Pleistocene streams entered large lakes. May include low-stand alluvial fan deposits
- Ql Lake deposits (Pleistocene)**—Sand, gravel, silt, clay, and evaporite deposited in small lakes impounded by lava flows and faults in the Egli Rim quadrangle and vicinity

CENOZOIC VOLCANIC AND SEDIMENTARY ROCKS

QUATERNARY AND LATE TERTIARY VOLCANIC ROCKS OF THE BASIN AND RANGE PROVINCE

Volcanics along Winter Ridge

The west slope of Winter Ridge is buried by a suite of Pleistocene lava flows erupted from volcanic centers on near the rim and aligned along cross faults (e.g. vent deposits aligned south and west of Dead Indian Mountain.

- QTv Vent facies (Quaternary or Neogene)**—Vent deposits and near vent lava flows. May also include small, round remnants of lava flows on low ridge tops.
- QTcv Vent facies, cinders (Quaternary and/or Neogene)**—Cinders, red to black. Includes blocks of plagioclase phyric (~2mm) basalt scoria sampled at a vent in the southwest quarter of the Summer Lake quadrangle. Sample number 512-24-3.

Angular unconformity ?

Picture Rock Basalt (upper Miocene and Pliocene; reverse polarity)— Basalt sequence, possibly with minor basaltic andesite(?), and andesite, that form a thick (>200 meters) sequence of lava flows originally described by Hampton (1964) surround and lie beneath the Fort Rock Lake basin, including the northern and eastern parts of the Egli Rim quadrangle. Radiometric age dates (Ricker and Niewendorp, 2013) suggest eruption of the lavas occurred prior to 6.8 Ma and between 6.8 and about 5.2 Ma. The Geological Society of America (2009) timescale reports that the earth's magnetic field had predominantly normal polarity at 6.8 Ma and experienced several reversals by 5.2 Ma. Egli Rim lava flows at the type section on the southern end of Egli Rim all have reverse polarity (Sean Gallagher, Portland State University, personal communication), suggesting that this thick sequence of lavas erupted over a relatively short period, perhaps a bit earlier than 6.8 Ma or during a very short interval of reversed polarity. Lavas are locally separated by thin intervals of sedimentary and pyroclastic rock as illustrated by Travis (1977). Locally divided to show selected individual flow units including:

Tkp Basalt of Klippel Point (upper Miocene, or Pliocene; reverse polarity)—Several basalt and andesite lava flows exposed in the vicinity of Klippel Point. From top to bottom this section includes basaltic lava flow (Sample number 612-1-3 from talus) basaltic lava flow (513-7-5), upper orange ash-flow tuff (Unit Tts), basaltic lava flow (Sample number 513-7-3), basaltic lava flow (Sample number 513-7-1), lower orange ash-flow tuff (Unit Tts), mixed tuffaceous sediment (Unit Tts), and lower andesite. South- to southwest-dipping flows appear to thicken toward Klippel Point. Lava is generally aphyric, with medium groundmass having a granular or sugary texture. Light green olivine microphenocrysts to 0.8 mm. Plagioclase microphenocrysts to 0.8mm. Interpreted to overlie basalt of Picture Rock Pass. Underlies adjacent lake deposits of unit Qtd in gravel pits and ancient shorelines to the west

Tbs1 Basalt of Section 1, T. 29 S., R. 16 E. (upper Miocene or Pliocene)—Platy plagioclase basalt lava flow contains crudely aligned irregular vesicles or amygdules with partial to complete zeolite fills. Small aligned twinned plagioclase crystals define a crude trachytic texture. Plagioclase phenocrysts as large as 3 mm. Sample Number 712-13-3.

Tbol Basalt of Old Lake Road (late Miocene)—Poorly exposed, massive to locally diktytaxitic, plagioclase aphyric basalt flow that crops out as

boulders on a low rise along Old Lake Road in the southern part of the Thorn Lake quadrangle. Thickness is unknown, but probably exaggerated on geologic map. Overlain by surficial units including terrace and alluvial fan deposits. Groundmass is fine. Diktytaxitic zone on Sample 512-23-1 is somewhat coarser grained and contains orthopyroxene rods to 0.5 x 0.5 x 4 mm. Seriate plagioclase is clear and as large as 2 mm. Fresh rock is dark gray. Titanium content is among the highest in the area (TiO₂=1.84%). The one sample measured had reverse magnetic polarity. Chemical composition and magnetic polarity are similar to basalt of Egli Rim flow unit Tbe16 and lavas on the west side of Hansen Valley in the Sand Rock quadrangle to the east. Age based on stratigraphic position. Associated bedrock units were not observed, but geomorphology suggests this lava flow lies above the basalt of Egli Rim. (Sample number 512-23-1)

Tbdi Basalt of Dead Indian Rim (upper Miocene or Pliocene)—

Diktytaxitic plagioclase phyric basalt. Plagioclase is gray to white and seriate to >3 mm. Groundmass is coarse and may locally be medium grained (diabase). Color is light gray fresh, medium gray weathered. In the sample examined, round vesicles are less than 1% of the rock and as large as 3 mm. Outcrops are blocky with blocks to several meters across. Locally equivalent to Hayes Butte Basalt of Hampton (1964). Chemistry, mineralogy, and texture are similar to that of coarse-grained diktytaxitic intrusive gabbro(?) (Unit QT_i, Sample Number 512-24-5) that crops out in the northwest quarter of the Summer Lake quadrangle. Sample number 512-24-8

Tts Tuff and sedimentary rock interlayered with Picture Rock Basalt (upper Miocene and Pliocene)—

Orange, red, white, and tan colored ash-flow tuff and associated lacustrine sedimentary rocks exposed at Klippel Point. Uppermost exposed in a layer ranging from 0.6-2.0 m (2-6.5 ft) thick. Rock is poorly sorted to unsorted ash with pumice fragments to 3 cm (1.2 in.) and basalt fragments to two cm (0.8 in). Pumice little flattened (Travis, 1977). Sample number 612-1-2

Tobu Olivine basalt of Squaw Lake (upper Miocene or Pliocene)—

Diktytaxitic olivine basalt is exposed in T. 29 S., R. 16 E., sections 1, 2, 11, and 12 in the eastern part of the Egli Rim quadrangle near Squaw Lake. Olivine phenocrysts are 1-2 mm, medium green to altered

brown. Rock is medium gray fresh, reddish brown weathered. Sample number 712-13-5

Tbpr Basalt of Picture Rock Pass (Miocene; reverse polarity)—
Diktytaxitic basalt, aphyric to plagioclase phyric, plagioclase is equant and seriate to 3 mm; groundmass is coarse (locally as coarse as medium grained [$>1\text{mm}$, average grainsize]). Abundant pipe-shaped vesicles(?) 0.5 to 2 in. (1 to 5 cm) in diameter filled by more vesicular lava. Rills and patterned ground distinguish this young lava flow on aerial photographs. Tumalo exposed on eastern side of Klippel Point. Thickness of 13 m (42.7 ft) measured by Travis (1977) on the east side of Klippel Point may include tumalo. Appears to lap onto the top of unit Tber west of Picture Rock Pass. Sample number 512-2-3

Tbtl Basalt of Thorn Lake (late Miocene) —Massive to vesicular, locally diktytaxitic plagioclase basalt that is poorly exposed along Old Lake Road southeast of Thorn Lake. Thickness is unknown, probably exaggerated on geologic map. Medium groundmass is granular. Round vesicles are locally amygdaloidal. Clear to light yellow plagioclase is seriate to 2 mm. Two measured hand samples had reverse magnetic polarity. Age based on stratigraphic position. Associated bedrock units were not observed, but geomorphology suggest this lava flow lies above the basalt of Egli Rim. (Sample number 512-23-2)

Tka Andesite (Miocene)—Andesite exposed at the base of the section at Klippel Point. Travis (1977) reports that the andesite contains olivine and plagioclase microphenocrysts to 1 mm in a felty (pilotaxitic?) groundmass. Age based on stratigraphic position beneath the basalt of Picture Rock Pass

Local(?) unconformity

Egli Rim Section

Tber Diktytaxitic basalt of Egli Rim (Miocene; reverse polarity)—
Aphyric basalt, olivine basalt, plagioclase phyric basalt, and glomeroporphyritic olivine basalt lava flows. Locally with thin intervening sediment (perhaps a tens of millimeters) or rubbly interflow zones and poorly developed paleosols. Sample numbers 512-

2-1 (lower, vesicular flow with reverse polarity) and 512-2-2 (upper, massive flow with mixed polarity). May include Basalt of Dead Indian Rim. Subunit descriptions are largely based on thin sections cut from the sample number cited and may miss uncommon larger phenocrysts. Typical thin sections show anhedral to euhedral olivine; interstitial(?) green clinopyroxene that may be optically continuous to 2mm; albite-twinning plagioclase (bytownite, An₇₀₋₈₂) lath that are slightly more calcic in olivine phyric flows and more sodic in aphyric or plagioclase phyric flows. Major oxides, normalized with iron reported as FeO, range as follows: SiO₂ 47.51-49.04, TiO₂ 1.41-1.74, Al₂O₃ 16.27-17.90, FeO 11.11-12.23, MnO 0.19-0.20, MgO 6.63-8.61, CaO 9.01-10.43, Na₂O 2.93-3.55, K₂O 0.40-0.66, and P₂O₅ 0.28-0.46%. These lavas are lithologically and chemically similar to several lava flows in the Hansen Valley area on the Sand Rock and Buffalo Wells quadrangles to the east-northeast. Locally divided to show:

Tbeu Upper lava flows—Includes lava flows 15 and 16. Flow 16 is a diktytaxitic plagioclase phyric basalt that contains seriate plagioclase lath as large as 3mm, has a coarse groundmass of plagioclase lath, olivine microphenocrysts, interstitial clinopyroxene (often optically continuous up to 1.2mm), and opaque oxides that are elongate (0.7 mm), v-shaped (0.3mm), or equant (0.3mm). Sample number ER-L16.

Flow 15 is a glomeroporphyritic olivine basalt with olivine phenocrysts to 2mm; euhedral to anhedral, locally appears to have been resorbed, typically with iddingsitized rims and often with opaque oxide inclusions. Plagioclase as lath to 3 x 0.5 mm. Clinopyroxene appears to be interstitial but may be optically continuous across 1.0mm. Patches of anhedral calcite(?) aggregate to 1.5mm. Opaque oxides to 0.2 mm; equant to 3:1 aspect ratio. Olivine and/or plagioclase glomerocrysts up to 4 mm. Sample number ER-L15.

Tbem Middle lava flows—Includes lava flows 5 through 14. Flow 14 is a plagioclase phyric basalt. Seriate plagioclase lath are up to 1.5mm by 0.3mm. Crystalline groundmass of plagioclase lath, interstitial clinopyroxene, euhedral to anhedral olivine microphenocrysts to 0.8mm, and granular (<0.3mm; may partly to entirely enclose other crystals) or elongate (0.4mm) opaque

oxides (also as alteration rims on pyroxene). Sample number ER-L14

Flow 13 is an aphyric basalt that contains subhedral olivine microphenocrysts to 0.4mm and a few stubby clinopyroxene microphenocrysts to 0.5mm. A few glomerocrysts as large as 1.5mm. Crystalline groundmass of crudely aligned plagioclase lath interstitial to subhedral pyroxene, subhedral olivine microphenocrysts and bimodal opaque oxides occurring as either equant crystals (0.3mm) or needles (0.4mm). Sample number ER-L13

Flow 12 is a diktytaxitic plagioclase and leucite(?) phyric basalt. Plagioclase occurs as seriate, albite-twinned lath to 2.0 x 0.3 mm. Equant opaque oxide microphenocrysts to 0.3mm (magnetite?); often partly or entirely surrounding tiny included olivine or pyroxene crystals. Also elongate or skeletal opaque oxides (ilmenite?). Clinopyroxene microphenocrysts to 0.7mm. Crystalline groundmass with subhedral to fractured olivine granules; randomly oriented seriate twinned plagioclase lath; interstitial, slightly brown-green pleochroic pyroxene; and seriate opaque oxides. Sample number ER-L12.

Flow 11 is a plagioclase phyric diktytaxitic basalt. Abundant equant to blocky opaque oxide microphenocrysts to 0.8mm. Leucite (?) to 0.6mm. Patches of calcite aggregate to 0.5mm. Crystalline groundmass of plagioclase lath, pyroxene (optically continuous to 0.6mm), subhedral to granular olivine, and opaque oxides. Sample number ER-L11.

Flow 10 is a diktytaxitic plagioclase phyric basalt. Albite-twinned plagioclase lath are seriate to 2mm. Crystalline groundmass of plagioclase lath, clinopyroxene (optically continuous to 1.0mm), subhedral olivine, and opaque oxides. Sample number ER-L10

Flow 9 is a diktytaxitic plagioclase phyric basalt in which plagioclase lath are seriate to 2mm. Patches of granular, aggregate calcite. Possible leucite/analcime? Crystalline groundmass of plagioclase lath, clinopyroxene (near parallel extinction and very weakly pleochroic light greenish to light

brownish-greenish on some faces), subhedral olivine, and equant to elongate opaque oxides. Sample number ER-L09.

Flow 8 is a diktytaxitic plagioclase phyric basalt. Plagioclase lath are seriate to 1.7mm. Crystalline groundmass of plagioclase lath, pyroxene, subhedral olivine, and equant to elongate to marginal opaque oxides. Sample number ER-L08

Flow 7 is a diktytaxitic aphyric basalt. Plagioclase lath are seriate to 1 mm. Olivine microphenocrysts are <0.6mm. Fine crystalline groundmass of plagioclase lath, pyroxene (optically continuous to 0.8mm), olivine, and elongate (needles to 0.5mm) to equant opaque oxides. Sample number ER-L07.

Flow 6 is a diktytaxitic aphyric basalt that has a fine crystalline groundmass of seriate plagioclase lath as large as 1 mm, clinopyroxene that appears to be interstitial but is optically continuous to 1.0mm, olivine as anhedral microphenocrysts <0.5 mm, and elongate to equant opaque oxides. Sample number ER-L06

Flow 5 is a plagioclase phyric vesicular and diktytaxitic basalt. Plagioclase lath) are seriate to 1.3mm. Olivine microphenocrysts are subhedral to anhedral, <0.9mm. Crystalline groundmass is composed of plagioclase lath, interstitial clinopyroxene that may be optically continuous to 1.0mm, subhedral to anhedral olivine, and elongate to equant opaque oxides (including abundant needles to 0.6 mm). Vesicles in thin section of sample number ER-L05 are of round and rounded irregular types ~1cm and sub-mm diktytaxitic types.

Tbel Lower lava flows—Includes olivine phyric lava flows one through four. Flow number four is a diktytaxitic glomeroporphyritic olivine basalt. Olivine is subhedral to anhedral and less than 1.5 mm. Olivine glomerocrysts are as large as 2.3mm. Plagioclase occurs as crudely aligned, radial, or randomly oriented seriate lath to 1.3mm and as zoned, resorbed, altered labradorite tablets to 1.3mm. Coarse crystalline groundmass consists of plagioclase lath, optically continuous interstitial clinopyroxene to 2mm, subhedral to anhedral olivine, and equant to elongate opaque oxides. Sample number ER-L04.

Lava flow three is a glomeroporphyritic olivine basalt. Olivine as euhedral to subhedral crystals to 2mm and glomerocrysts to 3.0mm. Plagioclase phenocrysts include tablets and seriate lath <1.5 mm. Medium crystalline groundmass of seriate plagioclase lath, clinopyroxene, olivine, and elongate (<0.4mm) or equant (<0.2mm) opaque oxides. Sample number ER-L03.

Lava flow two is a diktytaxitic, glomeroporphyritic olivine basalt with olivine phenocrysts as large as 2.7mm. Plagioclase lath to 3mm. Glomerocrysts of olivine, optically continuous clinopyroxene (<3.0mm), and plagioclase are as large as 6mm. Blocky to anhedral opaque oxides are far more common in some areas than others, giving a patchy appearance to thin sections held to a light. Coarse groundmass consists primarily of seriate plagioclase lath, clinopyroxene, olivine, and opaque oxides. Sample number ER-L02.

Lava flow one, the lowest exposed lava sampled on Egli Rim is a diktytaxitic, glomeroporphyritic olivine basalt. Olivine occurs as euhedral to subhedral crystals to 2mm. Fewer and smaller diktytaxitic vesicles than other lavas of this group; a few round vesicles to 4mm were observed in thin section of sample ER-L01. Plagioclase occurs as seriate lath and larger tablets to 3.1 x 1mm. Glomerocrysts of olivine to 3mm. Coarse groundmass consists mainly of olivine, clinopyroxene, plagioclase lath, and opaque oxides. Sample number ER-L01.

Winter Ridge Area

Tbad Basalt of Duncan Creek (upper Miocene)—Aphyric to sparsely plagioclase or olivine phyric basalt. Plagioclase phenocrysts are seriate to 2 mm, sparse in some areas. Locally contains olivine phenocrysts and microphenocrysts to 1.2 mm. Groundmass is fine to medium. Diktytaxitic or tiny irregular vesicles smaller than 1 mm. Light to medium gray fresh, tan to brown to orange weathered. One or more poorly exposed, locally blocky lava flows that cover much of the northwestern quadrant of the Summer Lake quadrangle. Sample numbers 512-24-4, and 512-24-6.

Tbfp Glomeroporphyritic olivine basalt of Fremont Point (upper Miocene)—Diktytaxitic, glomeroporphyritic olivine basalt flows are medium gray fresh, tan weathered. Brown olivine phenocrysts and microphenocrysts

are up to 1-2 mm. Glomerocrysts, 0.5 to 2.0 cm; are composed of olivine +/- clinopyroxene in plagioclase. Locally contains round vesicles with diktytaxitic halos. Blocky (~2.5 m) lava flow has 10-m thick colonnade at the escarpment. Age based on stratigraphic position and deformation history similar to 5.2 to 7.7 Ma lavas that crop out in the Egli Rim quadrangle to the north. Chemical variation in suggests that there are at least two flows. Sample numbers 512-24-1 and 512-24-2.

Tbu Basalt, upper (upper Miocene)—undivided basaltic rocks lying above andesite of Travis (1977) and beneath the basalt of Fremont Point.

Tat Andesite of Travis (1977; upper Miocene)—Andesite flow that forms the prominent ~100-meter-thick band on the Winter Ridge escarpment beneath Fremont Point. Generally thins northward but is recognizable more than 8 km (5 mi) from the southern edge of the mapped area. Travis (1977) described rock in the canyon beneath Fremont Point as light gray, aphyric, non-magnetic, platy andesite with olivine and plagioclase microphenocrysts to 1 mm and glassy groundmass. He correlated those rocks with andesite encountered at a similar stratigraphic position 8 km to the north near Summer Lake.

Tbl Basalt, lower (middle or upper Miocene)—undivided basaltic sequence lying beneath andesite of Travis (1977). Travis reports seven mafic lava flows ranging in thickness from five to fourteen meters with reverse magnetic polarity, dark gray color, and glassy to fine-grained groundmass that may be diktytaxitic. He reports modal composition of one flow as: plagioclase 61%, pyroxene 34%, olivine 4%, and magnetite 1%.

Grizzley Volcanic Center (Miocene)—Age based on stratigraphic position, interpreted as caldera overlapped by lava flows with radiometric ages greater than 7 million years. However, the absence of Picture Rock basalt at White Rock, Grizzley, and Dead Indian Mountain suggests that these places were high enough to avoid being covered by the basalt when it erupted.

Tgm Mixed volcanic rocks, including pyroclastic and volcanoclastic sedimentary rocks—Typically mapped where individual units are small and not divided for this study. Lithologies include lava flows, tuff, sandstone, siltstone, conglomerate, water-laid tuff, and vent deposits. More extensive

units, and units that could be defined on the basis of topography, structure, and distribution of limited field traverses, include:

- Tgr** **Rhyolite (Miocene)**—Spongy rhyolite preserved in a few blocky outcrops above the road in section 33, T. 29 S., R. 16 E. Plagioclase phyric with <1% equant phenocrysts to 3 mm. Groundmass is glassy and vesicular such that the rock locally consists mainly of bunched, parallel, air-filled glassy pipe vesicles. Travis (1977) reports a rhyolite intrusion from the White Rock area. Sample number 1012-12-1.
- Tgbu** **Basalt, upper (Miocene?)**—Diktytaxitic to vesicular basalt. Several lava flows. Medium gray fresh, brown to tannish-gray weathered. Sparsely plagioclase phyric with equant to lath-shaped crystals to 4 mm (Highway 31 lava flow with “V” shaped glomerocrysts). Medium groundmass is intergranular with sparse olivine or augite microphenocrysts. Several normal polarity, plagioclase phyric basalt flows with similar chemistry (SiO₂~51%, TiO₂~1.2 %) that crop out along and just east of Winter Ridge Road in the northwest corner of Section 2, T. 30 S., R.16E., along Winter Ridge Road in the northwest corner of Section 35, T. 29 S., R. 16 E. (Sample number 512-23-3), and a reverse polarity lava flow and dike west of Oregon Highway 31 in the west half of Section 36, T. 29 S., R. 16 E. (Sample numbers 512-1-1 and 512-1-2). Vent and/or fissure zones include scoria and welded splatter and aerial bombs oxidized red. Locally trachytic. Age based on interpretation of stratigraphic position and mixed magnetic polarities. Sample numbers 512-1-1 (lava flow), 512-1-2 (dike in splatter), and 512-23-3 lava flow
- Tgcv** **Cinders and younger vent facies (Miocene)**—Cinder and volcanic vent deposits.
- Tgwt** **White Rock Tuff (Miocene)**—Travis (1977) reports 90 m of light gray rhyolitic ash-flow tuff and block and ash tuff with tuff fragments ranging from 1 cm (0.4 in) to 1 m (3.28 ft) and other lithic fragments up to 8 cm (3.2 in). The unit ranges from massive or very crudely bedded to distinctly bedded with beds 25 to 50 cm (10 to 20 in) thick showing internal unconformities. At White rock, the unit shows variable dips steep as 43 degrees, locally forms hoodoo or badlands topography, and is overlain by a lava flow

- Tgob** **Obsidian breccia of Travis, 1977 (Miocene)**—More than 90 m (295 ft) of fragmental obsidian up to 1 m (3.28 ft) in diameter
- Tgbl** **Basalt, lower (Miocene)**—Gray olivine microphyric basalt with incipient diktytaxitic porosity. Locally with larger round vesicles. Locally oxidized
- Tgvo** **Older vent facies (Miocene)**—Areas of vent facies interlayered with lower parts of Grizzley volcanic center
- Tgt** **Trachydacitic orthopyroxene ash tuff (lower or middle Miocene)**—Orthopyroxene(?)-plagioclase tuff is gray fresh, reddish weathered.
- Tgtr** **Rheomorphic block and ash tuff (lower or middle Miocene)**—Deformed block and ash tuff crops out in northwest $\frac{1}{4}$ of Section 8, T. 30 S., R. 16 E.
- Tgtv** **Trachydacitic vitrophyre (lower or middle Miocene)** — Plagioclase phyric dacitic vitrophyre. Plagioclase is tabular to 7 mm. Black fresh, tan to reddish-brown weathered. Glassy groundmass. Sample number 512-1-4
- Tgtw** **Trachydacite of Winter Ridge (lower or middle Miocene)**—Glomeroporphyritic orthopyroxene trachydacite; outcrops are blocky to platy with plates 1-7 cm thick (0.4-2.8 in); lava is light gray fresh, dark gray to reddish brown weathered; groundmass is fine; smokey-gray to light amber plagioclase phenocrysts to 4 mm. Chemical composition indicates a close relationship to trachydacitic ash tuff of Unit Tgt and related vitrophyre of Unit Tgtv. Dikes that appear to be of a similar lithology are present in the southeastern corner of Section 5, T. 30 S., R. 16 E. Sample number 512-23-4

Oligocene or Miocene Volcanic Rocks

- Tas** **Andesite of Summer Lake (Oligocene or Miocene)**—Altered andesite. Age based on Oligocene age reported from south end of Summer Lake/Paisley area (Walker, 1963) and a middle Miocene vertebrate fauna collected from sedimentary rocks interbedded with similar volcanic rocks along Harvey Creek, near the southwestern shore of Summer Lake (J.A. Shotwell, *in* Peterson and McIntyre (1970). Crops out for 600 m (1970 ft) along strike as broken pinnacles and blocks upslope from Summer Lake Lodge at the base of

Winter Ridge. Similar rocks that crop out to the south near Paisley are intruded by diorite dated at 32.6 ± 0.7 Ma (Muntzert, 1969).

Neogene or Quaternary Intrusive Rocks

QTi Vesicular olivine basalt (late Miocene, Pliocene, or Pleistocene)— Vesicular basalt (gabbro?) porphyry that crops out as a field of boulders defining a small, round area of exposure thought to be a stock intruded through lava flows on Winter Ridge. However, contacts were not observed and it is possible that these exposures are a remnant of a larger flow. Rock is light gray fresh, medium gray weathered. Groundmass is coarse, and may locally be medium grained (>1mm). Contains light brown olivine to 1.5 mm; plagioclase that forms seriate roundish tablets, is light gray to white in color, up to 8 mm in diameter and 2 mm thick. The rock is coarser than, but texturally, mineralogically, and chemically similar to, low silica (<50%) diktytaxitic basalt lava flows in the area. Most similar to the basalt of Dead Indian Rim, the lava flow that caps the rim along the west side of the graben six kilometers (3.375 mi) to the north (Sample Number 512-24-8). Sample Number 512-24-5.

REFERENCES

- Hampton, E.R., 1964, Geologic factors that control the occurrence and availability of ground water in the Fort Rock Basin, Lake County, Oregon: U.S. Geological Survey Professional Paper 383-B, 29 p.
- Ma, L., Madin, I.P., Olson, K.V., Watzig, R.J., Wells, R.E., and Priest, G.R., compilers, 2009, Oregon geologic data compilation [OGDC], release 5 (statewide): Oregon Department of Geology and Mineral Industries Digital Data Series OGDC-5, CD-ROM.
- Muntzert, J.K., 1969, The geology and mineral deposits of the Brattain District, Lake County, Oregon: Master's thesis, Corvallis, Oregon State University, 70 p.
- Peterson, N.V., and McIntyre, J.R., 1970, Reconnaissance geology and mineral resources of eastern Klamath County and western Lake County, Oregon: Oregon Department of Geology and Mineral Industries Bulletin 66, 70 p.
- Ricker, T.R., and Niewendorp, C.A., compilers, 2013, Radiometric Age Information Layer for Oregon, Release 1, Oregon Department of Geology and Mineral Industries Digital Data Series RAILO-1, scale 1:1000000.
- Travis, P.L., 1977, Geology of the area near the north end of Summer Lake, Lake County, Oregon: M.S. Thesis, University of Oregon, Eugene, 79 p., 2 plates, scale 1:63,360.
- Walker, G.W., 1963, Reconnaissance geologic map of the eastern half of the Klamath Falls (AMS) quadrangle, Lake and Klamath Counties, Oregon: U.S. Geological Survey Miscellaneous Field Studies Map MF-260, 1:250,000.

DISCLAIMER

This geologic map and explanation of map units were prepared as an account of work sponsored by an agency of the United States Government. Neither the United States Government nor any agency thereof, nor any of their employees, makes any warranty, express or implied, or assumes any legal liability or responsibility for the accuracy, completeness, or usefulness of any information, apparatus, product, or process disclosed, or represents that its use would not infringe privately owned rights. Reference herein to any specific commercial product, process, or service by trade name, trademark, manufacturer, or otherwise does not necessarily constitute or imply its endorsement, recommendation, or favoring by the United States Government or any agency thereof. The views and opinions of authors expressed herein do not necessarily state or reflect those of the United States Government or any agency thereof.

This report does not constitute a standard, specification, or regulation.

The Oregon Department of Geology and Mineral Industries is not liable for any claimed damage from the use of this information. The Federal Emergency Management Agency may, at any time in the future, revise the Base Flood Elevations for this study area. This study and Base Flood Elevation determination does not supersede any existing or future detailed analyses or determination performed by a licensed professional engineer. This analysis and mapping does not necessarily identify all areas subject to flooding, particularly from local drainage sources of small size.