

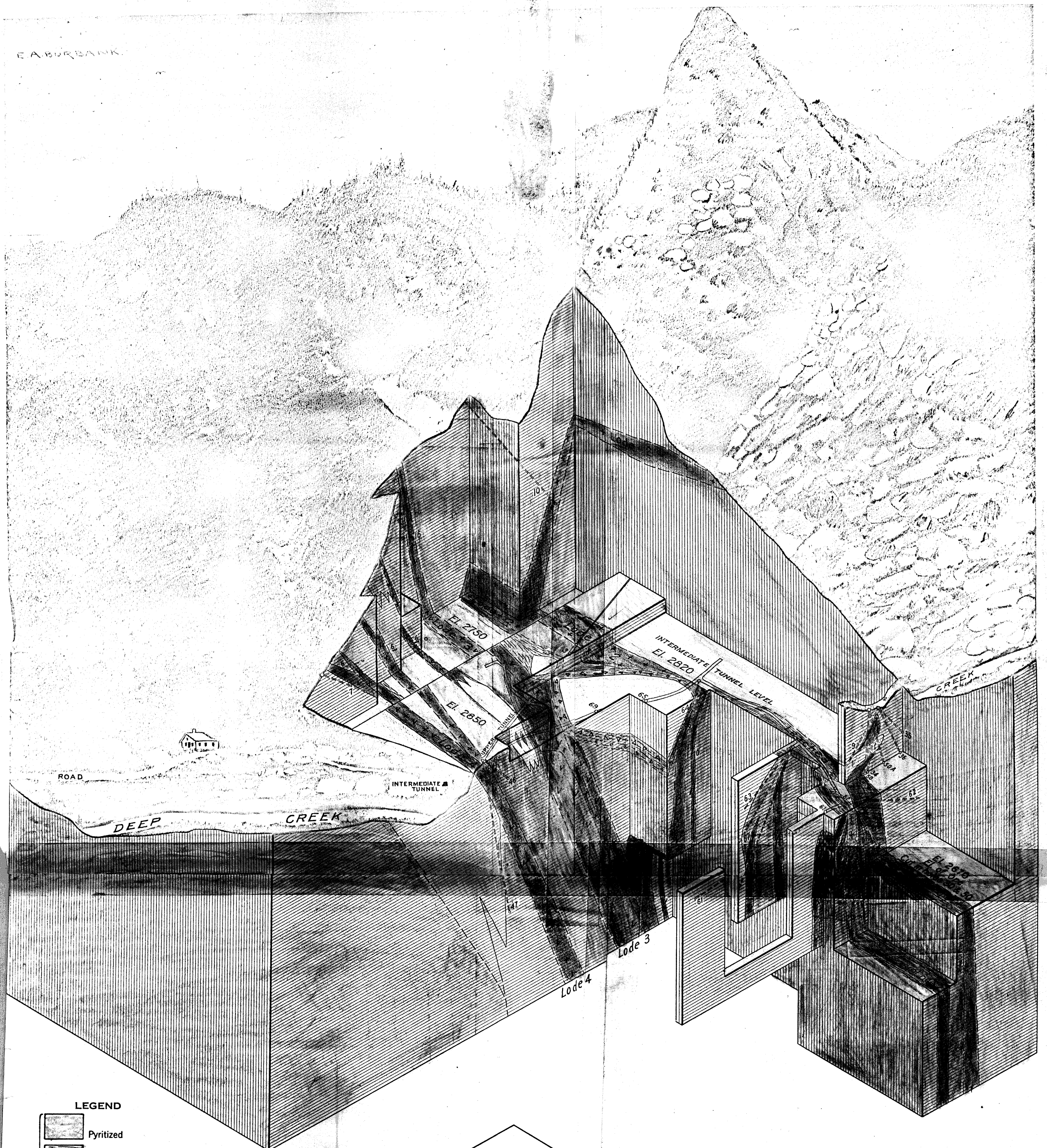





E. A. BURBANK

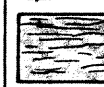
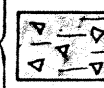

- LEGEND**
-  Pyritized
 -  Schistose
 -  Fragmental
 -  Copper bearing
 -  Zinc bearing
 -  Green stone
 -  Cordwood
- RED EDGE**

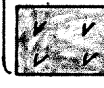

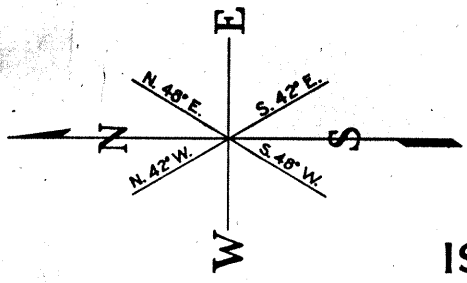
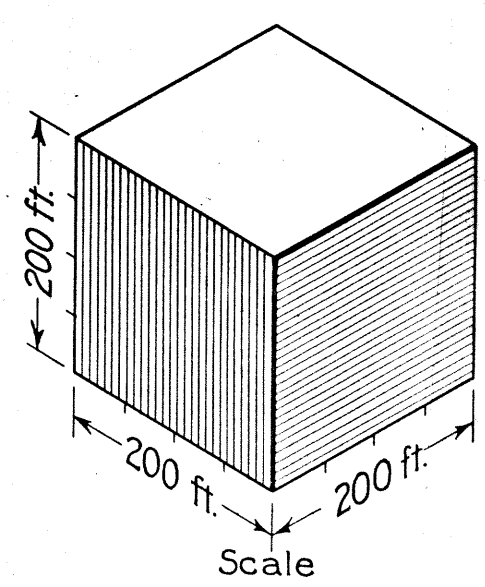
RED LEDGE MINE
ADAMS CO., IDAHO
ISOMETRIC BLOCK DIAGRAM

SHOWING
GEOLOGY AND ORE-BODIES

W. P. Butler
 F. M. Kalenborn
 January 1942