

WILLAMETTE HIGHWAY No. 18

Example:  **NHS/11**
 * Indicates a National Hwy. System Highway with a Functional Classification Code of 11.
 Example:  **08**
 * Indicates a Highway with a Functional Classification Code of 08. Not a National Hwy. System Highway.

FUNCTIONAL CLASSIFICATION SYSTEM

RURAL FUNCTIONAL SYSTEM			URBAN FUNCTIONAL SYSTEM		
01	Interstate System	07	Major Collector	16	Minor Arterial
02	Other Principal Arterial	08	Minor Collector	17	Collector
06	Minor Arterial	09	Local	19	Local
11	Interstate	12	Other Freeways and Expressways	14	Other Principal Arterials
14	Other Principal Arterials	14	Other Principal Arterials	14	Other Principal Arterials

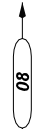
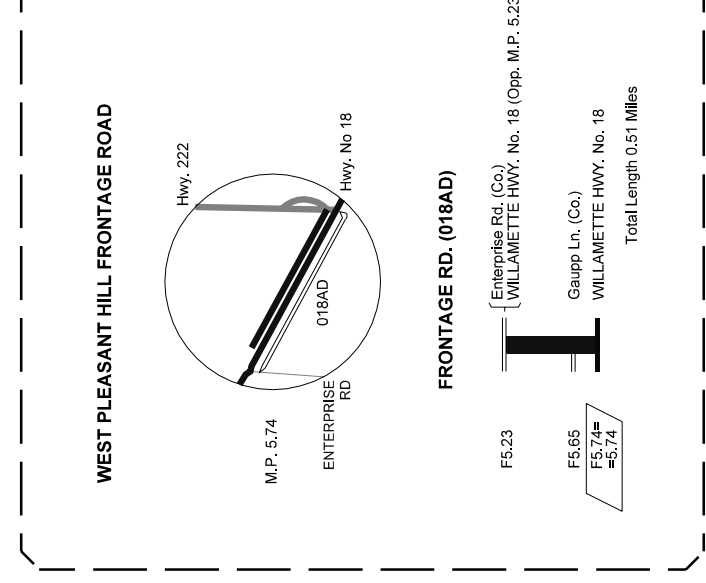
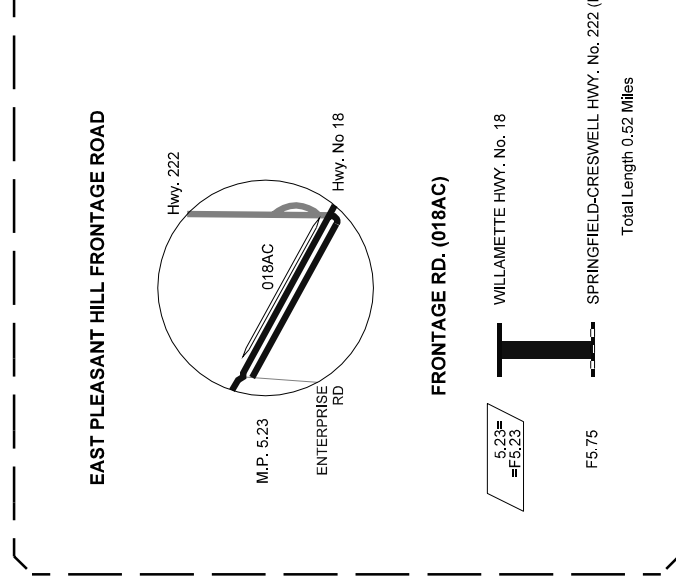
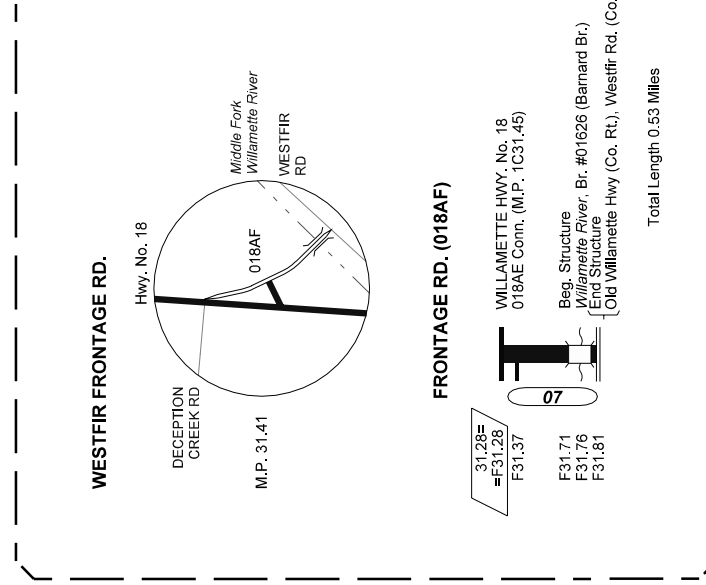
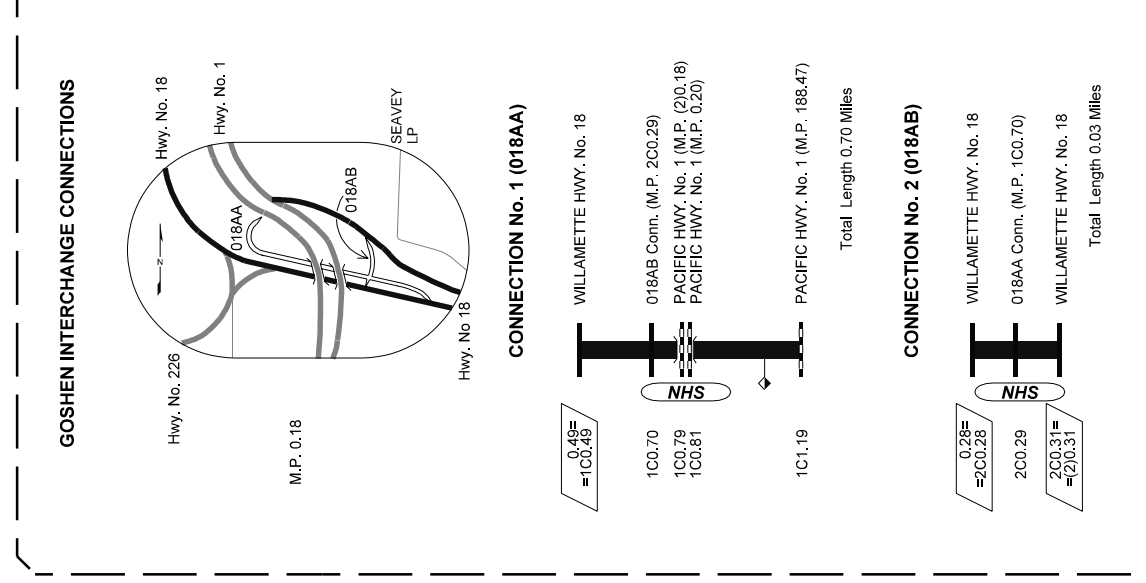
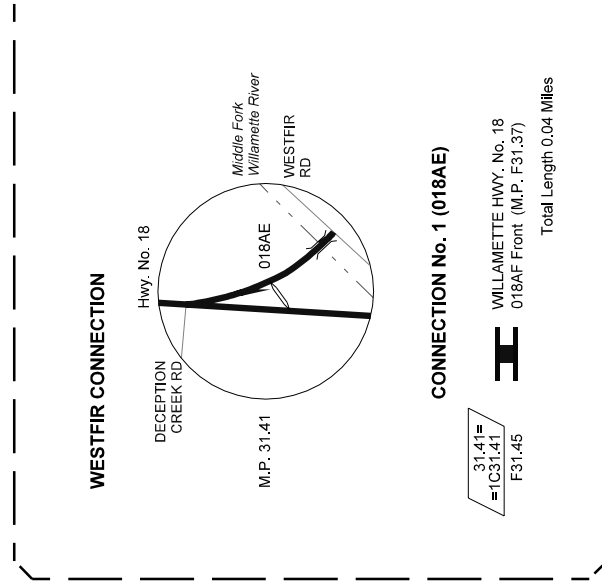

WILLAMETTE HIGHWAY No. 18

Example:  * Indicates a National Hwy. System Highway with a Functional Classification Code of 11. Not a National Hwy. System Highway.

FUNCTIONAL CLASSIFICATION SYSTEM

RURAL FUNCTIONAL SYSTEM		URBAN FUNCTIONAL SYSTEM	
01 Interstate System	07 Major Collector	11 Interstate	16 Minor Arterial
02 Other Principal Arterial	08 Minor Collector	12 Other Freeways and Expressways	17 Collector
06 Minor Arterial	09 Local	14 Other Principal Arterials	19 Local

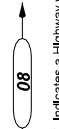
Example:  * Indicates a Highway with a Functional Classification Code of 08. Not a National Hwy. System Highway.

